

Affordable
LUXURY

Eastbrook 

www.eastbrooktrade.com



Bathroom

Collection

Issue 41 / October 1st
- January 31st 2020

Complete the LOOK

ROSANO VERTICAL RADIATOR

NEW

Flat Triple Hanger
Brushed Stainless Steel

Rosano Vertical Radiator
Matt White

Pipe Shroud & Collar Kit
White

Angled Thermostatic Valve
Matt White

Discover Your Bathrooms Potential

Welcome to the new edition of the Bathroom Collection. At the front of the catalogue you'll find a comprehensive overview of our range of over 5,000 products, to help you find what you're looking for.

We strive to produce a catalogue at least twice a year to ensure we have as much detailed information and newly added product ranges.

Our aim is to have visually appealing quality products for bathrooms, cloakrooms and en-suites of all shapes and sizes, and to suit all tastes and budgets.

We offer full technical backup for all customers, supported by large stocks and a dedicated single depot delivery service throughout the UK. This is to ensure all clients receive the best service from conception to completion and aftersales.

We have tried to ensure that all price and product information is correct at the time of going to print. However, the specifications contained in this catalogue are for information purposes only and are subject to change. Due to our ongoing policy of product development and improvement, all prices, specifications and features are subject to change without prior notice. We deliver all our goods on our own dedicated transport fleet to ensure a speedy and problem free service. However, in the unlikely event of a problem with any items, we would stongly recommend that customers order their goods with enough time to thoroughly check them and allow time for a replacement to be sent before installation commences. Errors and omissions excepted. As a company we encourage all of our customers to recycle all packaging from our products.

Baths



01

1200 & 1400mm	46-47
1500 & 1600mm	47-60
1700, 1800 & 1900mm	60-95
Showerbaths & screens	96-121
Freestanding baths	122-126
Offset baths	127-131
Corner baths	131-133

Bath Panels & Shower Screens



02

Bath panels	138-143
Toilet seats	144
Bath shower screens	145-147

Celsius Baths



03

Straight baths	150-151
Shower bath	152
Luxury baths	153-155
Celsius c-lenda	156-159

Hydrotherapy



04

Special order c-lenda whirlpools	162-167
Whirlpool baths for immediate delivery	168-171

Sanitaryware



05

Sanitaryware range	174-235
'Doc M' packs	190-191
Vanity, sit on and cloakroom basins	236-240
Semi-recessed basins	241
Back to wall pans	242-243
Wall hung pans	244
Concealed Cisterns	246
Accessories	247

Northbrook



06

Albano	252-255
Alento	256-259
Conca	260-261
Enza	262-265
Fino	266-273
Mezzano	274-275
Novara	276-279
Perlita	280-285
Piave	286-291
Tavo	292-293
Topino	294-295
Alento Ceramic Shelf	296
Accessories	297

Accessories



07

Alento range	302
Solid brass baskets	303
Salerno range	304-305
Genoa range	306-307
Rimini range	308-309
Rockingham range	310-311
Wastes	312
Bottle Traps, Levels, Frames & Fixings	313

Vanity & Fitted Furniture Ranges



08

Bonito Range	314-320
Bonito Slab	316-319
Bonito Corner Units	320
Castilla Drawer	321
Diamante Units	322-323
Faro Vanity Units	324-327
Madrid Vanity Units	328-331
Oslo Vanity Units	322-366
Oslo Combination Unit	353
Oslo Max	352
Oslo Combination Furniture	353-357
Oslo Semi Recessed	358-359
Oslo Tall Cistern Unit	360-362
Oslo Reduced Depth	363
Oslo Wall Hung	364-366
Seville Tableau	367-368
Sorrento Slab Units	369-371
Sorrento Vanity Units	372-374
Sorrento Wall-Hung Basins & Units	375-382
Sherwood Vanity Units	383
Bath Panels	384-386

Mirrors & Mirror Cabinets



09

Plain mirrors	390-391
Vanity mirrors	392
Mirrored cabinets	393-401
Mirrored corner cabinets	402
Mirrors with cornice	403-405
Mirrors with LED	405-412
Mirrors with florescent	413

Shower Enclosures



10

Volente enclosures	416-434
Vulcan enclosures	435-438
Vantage enclosures	439-445
Corniche enclosures	446-449
Vanguard enclosures	450-453
Walk-in enclosures	454-469
Biava Wet Floor	470-471
Shower trays	472-479

Panelling



11

Hydropanel	484-485
Mirror gloss hydropanel	486
Fitting instructions	487-488
Standard PVC hydropanel	489
PVC wide panels	490-491

Heated Towel Rails & Radiators



12

Multirail range	494-524
Designer range	525-563
Aluminium range	564-612
Stainless steel range	613-615
Traditional range	616-627
Elements	628-629
Valves	630-634
Accessories	635-637
Bespoke colours & sizes	638-639

Showering



13

Shower bundles	642-645
Traditional & modern shower valves	646-659
Riser kits & shower poles	660-667
Shower handsets, hoses & brackets	667-670
Shower arms	672-673
Shower heads	674-675
Accessories	676-677

Taps, Wastes & Accessories



14

Side valves & bath fillers	680-681
Prado range	691
Contemporary & modern taps	692-709
Traditional taps	710-713
Kitchen taps	713
Wastes, levers & accessories	714-716

Visual Contents



See pages 4-41

Index

Index Pages	718-720
Terms & Conditions	721

1200



Urban sit bath P46
1250x725mm

1500



Advantage 1500 P47
1500x800mm



Arc Single Ended 1500 P48
1500x700mm



Axis 1500 P48
1500x700mm

1400



Delta 1400 P46
1400x700mm



Delta 1500 P48
1500x700mm



Imperial 1500 P49
1500x700mm



Matrix 1500 TG P49
1500x700mm



Imperial 1400 P47
1400x700mm



Profile 1500 P50
1500x700mm



Profile Showerbath 1500 P99
1500x900mm



Quantum Integra Low Level P50
1500x700mm

1550



Status 1500 P101
1550x850mm



Quantum Integra Eco P50
1500x700mm



Quantum SE Integra P51
1500x900mm



Quantum SE P51
1500x700mm

1575



Swing 1575 P52
1575x850mm



Quantum 1500 Showerbath P98
1500 x 850-700mm



Urban 1500 P100
1500 x 742-892mm



Urban Edge 1575 P102
1575x850mm

1600

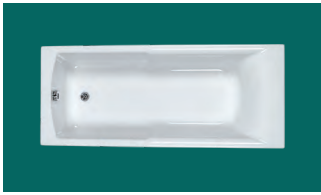

Axis 1600 P52
1600 x 700mm



Camden 1600 P56
1600 x 700mm



Delta 1600 P53
1600 x 700mm



Delta 1600 Showerbath P104
1600 x 410-800mm



Imperial 1600 P53
1600 x 700mm



Matrix 1600 P54
1600 x 700mm



Profile 1600 P54
1600 x 700mm



Profile Duo P54
1600 x 700mm



Quantum Integra Low Level P55
1600 x 700mm



Quantum Integra Eco P55
1600x700mm



Quantum SE Integra P56
1600x700mm



Quantum SE P55 & 57
1600x700/800mm



Quantum 1600 Showerbath P59
1600x850-700mm



Sigma 1600 P57
1600x750mm



Status 1600 P57
1600x725mm

1675 (5'6")



Delta 5'6" P59
1675x700mm



Imperial 5'6" P60
1675x700mm

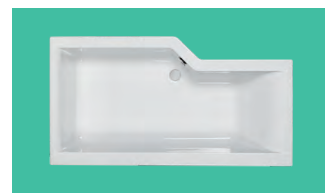

Urban Edge 1675 P108
1675x845x420mm

1650



Brio 1650 Showerbath P103
1650 x 700-845mm



Camden 1650 P58
1650 x 700mm



Delta 1650 P58
1650x700mm



Profile Duo 1650 P58
1650x700mm



Quantum Integra SE P59
1650x700mm

1700



Albany P60
1700x700mm



Alpha 1700 P74
1700x750mm



Apex P80
1700x800mm



Arc Duo 1700 P74
1700x750mm



Arc Shower Bath P118
1700x700-845mm



Arc Single Ended P61 & 75
1700x700/750mm



Axis 1700 P61
1700x700mm



Axis Offset Shower Bath P114-115
1700x700-800mm



Britannia Classic Super Deep P75
1700x750mm



Britannia Victoria P62
1700x750mm



Classic Shower Bath P75
1700x750mm



Camden 1700 P61
1700x700mm



Delta 1700 P62
1700x700mm



Delta 1700 Shower Bath P116
1700x700-800mm



Echelon 1700 P73
1700x750mm



Equation 1700 P70
1700x740mm



Equity 1700 P76
1700x750mm



Haiku P81
1700x800mm



Highgate P72
1700x750mm



Highgate Showerbath P109
1700x900mm



Ibis P63
1700x700mm



Imperial 1700 P63
1700x700mm



Matrix 1700 P64
1700x700mm



Neo Classical P64
1700x700mm



Profile 1700 P65 & 77
1700x700/750mm



Profile Duo 1700 P66, 77
1700x700/750mm



Quantum SE P66, 78, 82, 84
1700x700/750/800/900mm



Quantum Duo P66, 78, 82
1700x700/750/800mm

1700



Quantum Duo Integra P78
1700x750mm



Quantum Integra P68, 79 & 81
1700mx700/750/800mm



Quantum Integra Eco Low Level P67
1700x700mm



Quantum Integra Eco P67
1700x700mm



Quantum Shower Bath P112
1700x700-850mm



Quantum Space Saver P71
1700x742/395mm



Sigma P79 & 82
1700x750/800mm



Status 725 P69
1700x725mm



Status 800 P83
1700x800mm



Swallow 1700 P68
1700x700mm

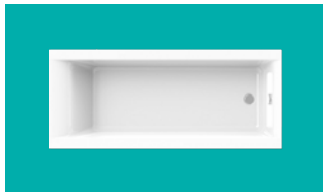

Urban 1700 P69
1700x725mm



Urban 1700 Showerbath P110
1700x742/892mm



Verona P80
1700x750mm



Zone P80
1700x750mm

1750



Halcyon P85
1750x800mm



Halcyon D P84
1745x800mm

1800



Alpha 1800 P89
1800x800mm



Arc Duo P90
1800x800mm



Biarritz Britannia P91
1800x800mm



Echelon 1800 P90
1800x800mm



Equation 1800 P86
1800x792mm



Equity 1800 P91
1800x800mm



Haiku P91 & 94
1800x800/900mm

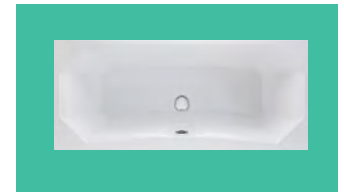

Hightgate 1800 P88
1800x800mm



Imperial 1800 P86
1800x750mm



Mistral P89
1800x900mm

1800



Profile SE P87
1800x700mm



Profile Duo P87
1800x700mm



Quantum 1800 P86 & 92
1800x725/800mm



Quantum Duo 1800 P92
1800x800mm



Quantum Integra P92
1800x800mm



Sigma 1800 P93
1800x800mm



Sigma Shower Bath P120
1800x740-900mm



Swallow 1800 P85
1800x700mm



Zone P94
1800x800mm

1900



Linea P95
1900x900mm



Quantum Duo P95
1900x900mm



Sigma 1900 P95
1900x900mm

Corner



Monarch P132
1300x1300mm



Centennial P133
1500x1500mm



Tranquility P133
1300x1300mm



Oriole P132
1200x1200mm



Bali P131
1200x1200mm



Rio P131
1050x1050mm

Offset Corner



Clipper P128
1575x1200mm



Dove P129
1550x950mm



Swan P130
1700x1000mm

Celsius



Celsius 1700 Single Ended P150
1700x700/750mm



Celsius Showerbath P152
1700x750-900mm



Celsius 1800 Double ended P151
1800x800mm

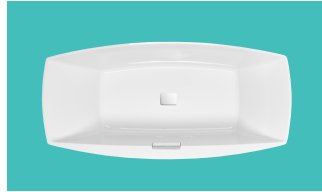

Celsius Freestanding P155
1900x900mm



Celsius Oval P154
1900x1000mm



Celsius Duo P153
2000x14000mm

Freestanding



Celsius Freestanding P126
1900x950mm



Halcyon Round Freestanding P122
1750x800mm



Halcyon Square Freestanding P123
1750x800mm



Highgate Freestanding P124
1750x800mm



Paradigm P125
1550x850mm

Whirlpool Baths

c-lenda jets - now available for immediate delivery on stocked whirlpools. Only 1mm protrusion from bath. Controls now on the inside vertical of the bath leaving the bath ledge clutter-free.

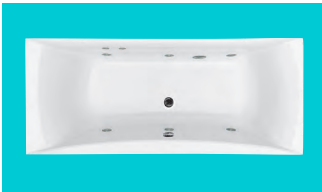

Albany 1700 P170
1700 x 700mm



Alpha 1700 P170
1700x750mm



Alpha 1800 P170
1800x800mm



Britannia Classic P168
1700x750mm



Delta 1700 P170
1700x700mm



Delta 1700 Shower Bath P171
1700x700/800mm



Equation P168
1700x750/800mm & 1800 x 800mm



Imperial 1700 P168
1700x700mm



Monarch P171
1300x1300mm



Sigma 1700 P170
1700x750mm



Sigma 1800 P170
1800x800mm



Status 1700 P169
1700x725/800mm



Quantum Duo 1700 P169
1700x750mm



Quantum SE 1700 P169
1700x750mm



Flush Air Control



Flush Suction



Flush Centro Jet



Flush Mini Jet



Flush Air Button/
Pneumatic Control

Panels & Screens



Quantum Panels

P136-137



Concord Panels

P136



L Shape Carronite Panels

P137

Sherwood Panels

Sherwood Panels

P138-140



Shower Screens



Bath Guard

P144



Sail Shape

P144



Cotswold Corniche

P144



Radius Corner

P144

Bath Screens



Volente Hinged
P146



Volente Hinged
P146



Volente Frosted
P147



Volente Hinged
P147



Type 1 Screen
P146

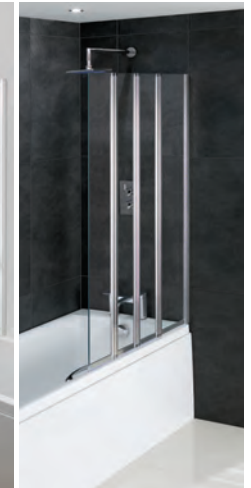

Volente Fixed & Folded
Panels
P145



Volente
Overbath Slider
P143



Volente
4 Fold/5 Fold
P145



250mm fixed,
750mm hinged
P143



Quantum:
P146



Volente Fixed &
4 Folding Panels
P145



Type 1:
P97

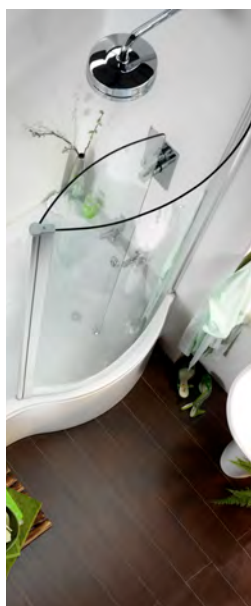

Type 2:
P97



Type 3:
P97



Standard:
P97



Quantum:
P97

Sanitaryware



Andelle 174



Anjou 175



Arkitect 176

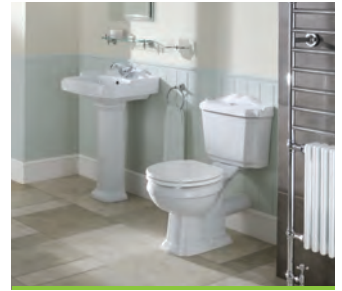

Belgravia 177



Bijou 178-179



Cheltenham 182



Cheverney 180-181



Collindale 184-185



Colorado 183



Courchevel 186-187



Crowthorne 188-189



Doc M 190-191



Dura 192-193



Elysée 194-195



Farrindon 196-197



Kompakt 200-201



Linea 202-203



Lisbon II 204-207



Loire 210-211



Maestro 212-213



Metro 214-217



Mentmore 220-221



Minima 218-219

Sanitaryware



Northhall 222-223



Pluton 224-225



Quadro 226



Quba 227



Tamarind 228-229



Temptation 230-231



Ultima 232-233



Wingrave 234-235



Albano 252-255



Alento 256-259



Conca 260-261



Enza 262-265



Fino 266-273



Mezzano 274-275



Novara 276-279



Perlita 280-285



Piave 286-291



Tavo 292-293



Topino 294-295

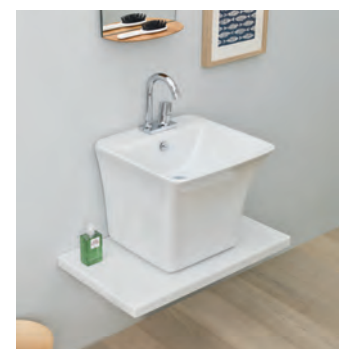

Alento Ceramic Shelf 296

Sanitaryware

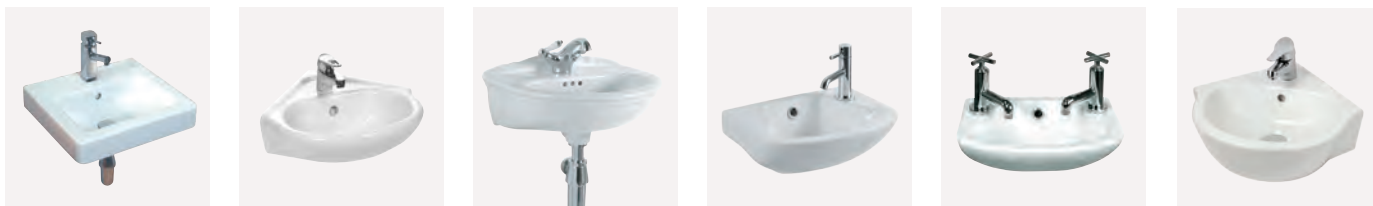

Cloakroom & Vanity Basins

The following is our range of basins in size order

Code	Description	Width	Page No
75.0008	Loire 350 x 250 cloakroom basin 1TH RH	350	209
75.0018	Loire 350 x 250 cloakroom basin 2TH	350	209
26.0011	Dura cloakroom basin 360 2TH	360	192
27.0781	Temptation basin 400 1TH	400	231
27.9711	Temptation basin 400 2TH	400	231
56.0016	Minima basin 416 1TH	416	239
27.0381	Kompact cloakroom basin 419 x 216 1TH RH	419	199
56.0056	Cloakroom basin 419 x 216 1TH	419	239
56.0057	Cloakroom basin 419 x 216 2TH	419	239
24.0010	Andelle 430 basin 1 TH	430	174
83.0017	Sorrento 45 ceramic top	450	237
27.0371	Kompact corner cloakroom basin 1TH	450	198
56.0055	Corner basin 450mm 1TH	450	239
27.0721	Temptation basin 450mm 1TH	450	280
75.0009	Loire 450 x 275 cloakroom basin 1TH	450	209
75.0019	Loire 450 x 275 cloakroom basin 2TH	450	209
26.0012	Dura cloakroom basin 450mm 2TH	450	192

Code	Description	Width	Page No
64.0019	Lisbon II cloakroom basin 450mm 1TH	450	205
64.0016	Lisbon II 450 x 450 corner basin 1TH	450	205
27.0401	Kompact Basin 457mm 1TH	457	199
56.0051	Cloakroom basin 457 x 358 1TH	457	239
56.0052	Cloakroom basin 457 x 358 2TH	457	239
26.0022	Tamarind 465 basin 1TH	465	229
26.0023	Tamarind 465 basin 2TH	465	229
27.0731	Temptation basin 500 1TH	500	231
26.0029	Crowthorne basin 500 1TH	500	189
56.0053	Cloakroom basin 509 x 240 1TH	509	279
56.0054	Cloakroom basin 509 x 240 2TH	509	239
27.0391	Kompact cloakroom basin 509 x 216 1TH RH	509	199
27.0921	Type 55 cloakroom basin 510 x 240 2TH	510	195
64.0018	Lisbon II 240 x 520 1TH	520	205
26.0024	Tamarind corner basin 1TH	525	229
64.0017	Lisbon II corner basin 550 x 550 1TH	550	205
64.0021	Lisbon II offset corner basin 570 1TH LH/RH	570	205



Basins on Pedestals

Code	Description	Width	Page No
56.0016	Minima basin 1TH	416	218
24.0010	Andelle 430 basin 430 1TH	430	174
75.0005	Loire 450 basin 1TH	450	209
75.0015	Loire 450 basin 2TH	450	209
26.0064	Farringdon 450 1TH	450	197
26.0066	Farringdon 450 1TH	500	197
27.0731	Temptation basin 500 1TH	500	231
26.0003	Dura basin 500 1TH	500	192
26.0025	Dura basin 500 2TH	500	192
75.0003	Loire 535 basin 1TH	535	209
26.0029	Crowthorne 500 basin 1TH	500	189
75.0014	Loire 535 basin 2TH	535	209
24.0008	Andelle basin 540 1TH	540	174
27.0851	Type 55 basin 2TH	544	195
26.0062	Farringdon 550 1TH	550	197
26.0075	Bijou 550 1TH	550	179
27.0341	Kompact 550 basin 1TH	550	199
64.0012	Lisbon II 550 basin 1TH	550	205
56.0046	Wingrave basin 550 1TH	550	234
26.0001	Dura 550 basin 1TH	550	192
83.0010	Pluton basin 555 1TH	555	225
26.0019	Tamarind 560 basin 1TH	560	229
26.0020	Tamarind 560 basin 2TH	560	229
56.0011	Linea basin 560 1TH	560	203
75.0007	Loire 400 corner basin 1TH	560	209
75.0017	Loire 400 corner basin 2TH	560	209
26.0027	Crowthorne 560 basin 1TH	560	189
27.0451	Temptation basin 575 1TH	575	231
56.0001	Ultima basin 590 1TH	590	233
24.0003	Belgravia basin 598 1TH	598	127
24.0004	Belgravia basin 598 2TH	598	177
27.0601	Cheltenham 1TH	598	182
27.9601	Cheltenham 2TH	598	182
83.0011	Pluton basin 600 1TH	600	225
56.0041	Maestro basin 600 1TH	600	213
64.0014	Lisbon II basin 600 1TH	600	205
26.0095	Metro slim rim basin 1TH	555	215
56.0027	Metro basin 1TH	610	215
26.0034	Mentmore 610 basin 1TH	610	221

Inset Basins / Sit on Basins

Code	Description	Width	Page No
51.032	Rondo sit on basin	412	236
51.029	Renata sit on basin	430	236
51.033	Barbro sit on basin	460	236
51.030	Natura sit on basin	500	236
51.028	Osanna inset basin	500	236
51.034	Pat inset basin	500	236
51.031	Pricilla sit on basin	510	236
26.0052	Vanity basin 515 x 415 1TH	515	240
26.0053	Vanity basin 515 x 415 2TH	515	240



Inset Basins / Sit on Basins

Code	Description	Width	Page No
75.0006	Loire semi-recessed basin 1TH	500	195
75.0016	Loire semi-recessed basin 2TH	500	195
60.0013	Type 55 semi-recessed basin 1TH	500	195
26.0009	Dura semi-recessed basin 1TH	513	192
56.0066	Minima semi-recessed reduced depth basin 1TH	523	218
56.0070	Wingrave semi-recessed basin 1TH	540	234
26.0076	Bijou Semi recessed basin 1TH	550	178
64.0026	Colorado semi-recessed basin 1TH	550	183
27.0361	Kompact reduced depth SR basin 1TH	560	198
27.9361	Kompact reduced depth SR basin 2TH	560	198
56.0064	Metro semi-recessed basin 1TH	563	214
64.0022	Lisbon II semi-recessed basin 1TH	570	205
10.018	Arkitekt semi-recessed vanity basin 1TH	575	176
83.0015	Pluton semi-recessed basin 1TH	580	224
26.0097	Metro Slim rim semi-recessed basin 1TH	580	214
26.0053	Vanity basin 515 x 415 2TH	515	240

Sanitary Ware



Close Coupled Pans

Code	Description	Projection from Wall	Page No
26.0071	Bijou pan	595	178
26.0067	Collindale BTW CC pan	608	182
27.0301	Kompact pan	610	198
64.0004	Lisbon II BTW CC WC pan	610	204
64.0007	Lisbon II Semi BTW CC WC pan	610	204
26.0059	Farringdon CC pan	615	196
26.0006	Dura pan	615	193
24.0006	Andelle pan	620	174
64.0023	Lisbon II CC pan	635	205
75.0020	Type 55 WC pan	635	180
26.0039	Northall pan	645	222
26.0036	Mentmore pan	650	221
26.0031	Crowthorne pan	650	188
56.0018	Minima pan	659	218
56.0033	Quba pan	665	227
56.0013	Linea pan	670	202
27.0581	Cheltenham pan	670	182

Code	Description	Projection from Wall	Page No
75.0001	Loire pan	670	208
56.0048	Wingrave pan	675	235
56.0003	Ultima pan	677	233
27.0431	Temptation pan	680	231
75.0012	Anjou High-level pan	680	175
56.0043	Maestro pan	685	213
26.0016	Tamarind pan	700	229
83.0002	Pluton fully BTW WC pan	710	224
56.0079	Quadro pan	715	226
24.0001	Belgravia pan	725	177
56.0028	Metro pan	738	214
75.0011	Loire corner	790	208
27.0311	Kompact corner pan	805	198
26.0092	Metro CC BTW pan	645	214
26.0093	Metro CC pan	650	214
26.0098	Metro Rimless CC BTW pan	645	214
26.0099	Metro Rimless CC pan	650	214



BTW and Wall Hung Pans

Code	Description	Projection from Wall	Page No
10.017	Arkitekt BTW pan	480	176
64.0010	Lisbon II BTW pan	480	204
26.0068	Collindale BTW pan	480	184
26.0072	Bijou wall hung pan	485	178
26.0073	Bijou BTW pan	480	178
27.0321	Kompact BTW pan	485	198
26.0081	Farringdon wall hung	495	196
83.0003	Pluton BTW pan	505	224
26.0058	Farringdon BTW pan	510	196
64.0001	Colorado BTW pan	520	183
64.0008	Lisbon II wall hung pan	520	204
56.0068	Minima BTW pan	528	218
56.0072	Wingrave BTW pan	533	234
83.0008	Pluton wall hung pan	540	224
75.0010	Loire BTW pan	540	208
26.0008	Dura BTW pan	540	192
75.0013	Anjou high level BTW pan	550	175
26.0041	Northall BTW	565	222
26.0104	Northall wallhung pan	480	222
40.0006	Moselle wall hung pan	570	246
56.0058	Metro BTW pan	575	214
40.0008	Somme wall hung pan	580	244
40.0004	Seine wall hung pan	610	244
26.0048	Dura wall hung pan	540	192



Standard Seat Matrix

Code	Description	To Fit Ranges	Page No
40.0001	Rhone seat	Anjou	175
40.0001	Rhone seat	Belgravia	177
40.0001	Rhone seat	Loire	208
40.0001	Rhone seat	Tamarind	228
50.001	Deluxe seat	Arkitekt	116
50.001	Deluxe seat	Loire	208
50.002	Soft close seat	Arkitekt	176
50.002	Soft close seat	Loire	208

Sanitaryware Accessories

Sanitaryware Accessories 246-247



Electronic Eco Flush

Throughout this section you will find various cisterns which are able to accommodate the Jollytronic universal bottom entry cistern fitting 7.0000.

The new, hygienic, no touch flushing system with water saving Eco-Stop flushing technology which allows the user to control how much water is needed to clear the toilet. This system flushes for as long as the sensor is covered which allows the user to flush the toilet for just the right length of

time needed to clear. It is a battery operated system giving a typical 15,000 flushing cycles before battery replacement is needed. It also has a manual over-ride in the unlikely event of battery failure.



Electronic Eco Flush

245

Sanitaryware



Toilet Spigot Dimensions

Lets make sure the toilet you're purchasing has the correct amount space from Spigot To Floor, Spigot To Wall & whether that model has as Open Foot Print (open bottom base).

Please see the dimension chart per toilet pan model below.



An measurement example diagram is on the right hand page.



Code	Description	Floor to Spigot (mm)	Wall to Spigot (mm)	Open Foot Print	Page No
75.0013	Anjou BTW	185	0	No	175
26.0073	Bijou BTW	185	0	No	178
26.0084	Bijou BTW Rimless	185	0	No	178
27.0101	Type 55 BTW	185	0	No	192
26.0008	Dura BTW	185	0	No	192
26.0047	Dura HL BTW	185	0	No	208
75.0010	Loire BTW	185	0	No	222
26.0055	Northall BTW HL	185	0	Yes	180
64.0001	Colorado BTW	185	20	No	183
26.0058	Farringdon BTW	185	20	No	196
26.0041	Northall BTW	185	20	Yes	222
10.017	Arkitect BTW	185	25	Yes	176
26.0068	Collindale BTW	185	30	No	184
83.0003	Pluton BTW	185	40	Yes	224
56.0072	Wingrave BTW	185	50	Yes	234
27.0321	Kompact BTW	185	55	Yes	198
56.0068	Minima BTW	185	55	Yes	218
56.0058	Metro BTW	185	85	Yes	214
75.0001	Loire CC Pan	185	100	Yes	208
75.0020	Type 55	185	110	Yes	180
26.0071	Bijou	185	120	No	178
26.0082	Bijou Rimless	185	120	No	178
26.0057	Farringdon BTW CC	185	120	Yes	196
64.0023	Lisbon II CC pan	185	120	Yes	204
83.0004	Pluton CC	185	120	No	224
26.0016	Tarmaid	185	120	No	228
26.0049	Dura BTW CC	185	130	No	192
26.0050	Dura BTW CC LH	185	130	Yes	192
26.0051	Dura BTW CC RH	185	130	Yes	192
26.0043	Dura HL BTW CC	185	130	No	192
26.0046	Dura HL CC	185	130	No	192
26.0059	Farringdon CC	185	130	Yes	196
27.0301	Kompact Pan	185	130	Yes	198
27.0431	Temptation	185	130	Yes	230
24.0006	Andelle	185	135	No	174
24.0001	Belgravia	185	140	Yes	177
26.0067	Collindale BTW CC	185	140	Yes	184
26.0036	Mentmore	185	140	No	220
26.0039	Northall	185	140	Yes	222
64.0007	Lisbon II semi BTW CC	185	150	Yes	204
27.0581	Cheltenham	185	160	Yes	182
26.0006	Dura Pan	185	160	No	192
26.0054	Northall CC BTW HL	185	160	Yes	222
64.0004	Lisbon II BTW CC	185	170	Yes	204
75.0012	Anjou High level	185	180	Yes	175
64.0010	Lisbon II BTW	185	180	Yes	204
56.0003	Ultima	185	180	Yes	232
56.0048	Wingrave	185	180	Yes	234
26.0031	Crowthorne	185	200	Yes	188
56.0013	Linea	185	200	Yes	202
56.0043	Maestro	185	200	Yes	213
56.0018	Minima	185	200	Yes	218
83.0002	Pluton BTW CC	185	220	Yes	224
27.0301	Kompact Pan (in corner situ)	185	230	Yes	198
75.0001	Loire CC pan (in corner situ)	185	240	No	208
56.0028	Metro	185	240	Yes	214

Sanitaryware

Toilet Spigot Dimensions (continued)



Code	Description	Floor to Spigot	Wall to Spigot	Open Foot Print	Page No
56.0043	Maestro	185	200	Yes	213



Code	Description	Floor to Spigot	Wall to Spigot	Open Foot Print	Page No
26.0041	Northall BTW	185	20	Yes	222

Vanity Units



Bonito Slab P316-319



Bonito 120 P314-315



Castilla Drawer Unit P321



Bonito P320



Diamante P323



Diamante 110 P322-323



Faro P324-327



Madrid P328-331



Oslo P332-366



Oslo Two Door & Two Drawer P332-342

Vanity Units



Oslo Combination P353-357



Oslo Max P352



Oslo Semi Recessed P358-359



Oslo Tall Cistern Unit



P360-362



Oslo Wall Hung P364-366



Oslo Internal/Push Drawer P344-351



Seville Tableau P367-368



Sorrento P372-374



Sorrento Slab P369-371

Mirrors

Cabinet Mirrors



Bonito 120 397



Bosini 393



Cabinets with cornices 395-396



Cabinets 399



Cabinet Mirrors 393



Caldini 1 Door Cabinet 394

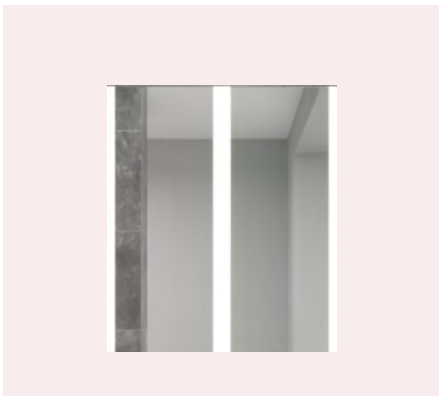

Caldini 2 Door Cabinet 394



Corner Units 402



Diamante 397



Faro 405



Geneva 398



Lucerne 398

Mirrors

Cabinet Mirrors

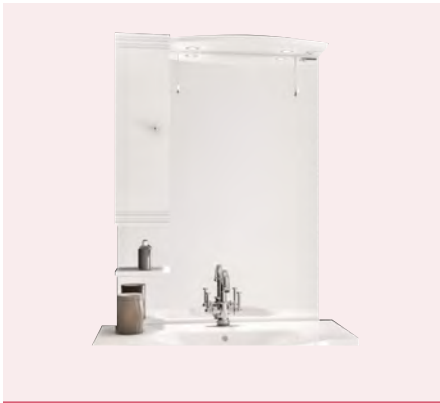

Madrid 403



Oslo 400

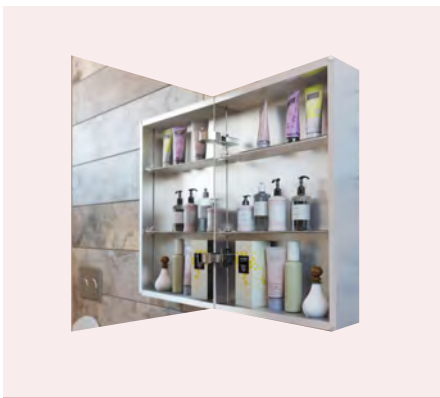

Ravini 401



Zurich 401

Plain Mirrors



Brunswick 390

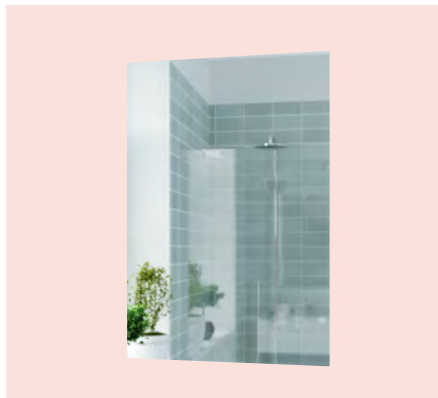

Plain Mirrors 391

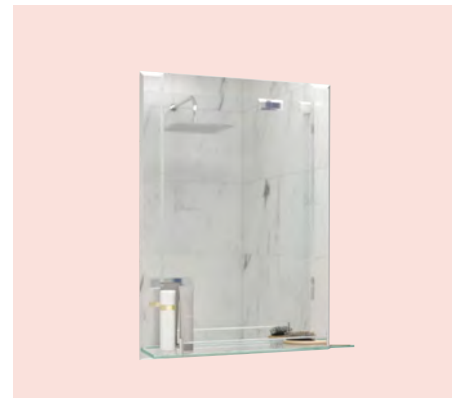

Savannah 390



Seattle 390



Vancouver 390

Mirrors

LED Light Mirrors

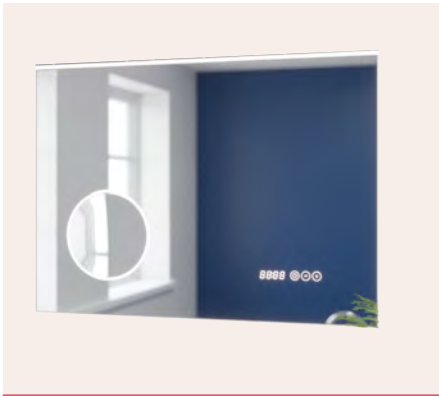

Bowmont

405

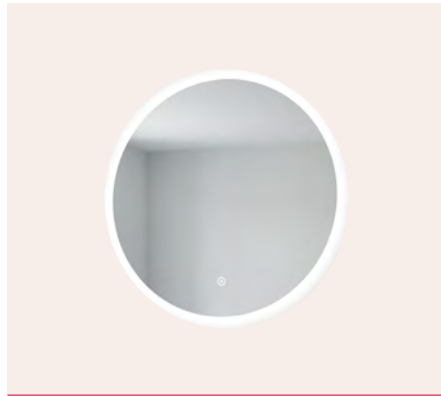

Ellera

406

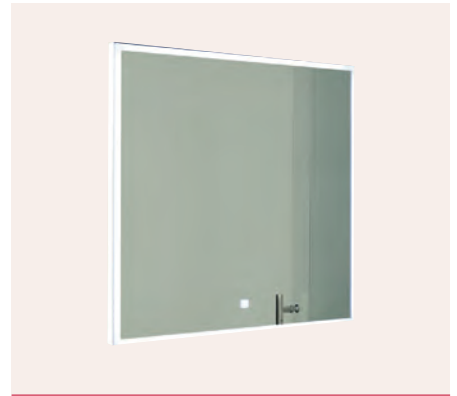

Esk

406

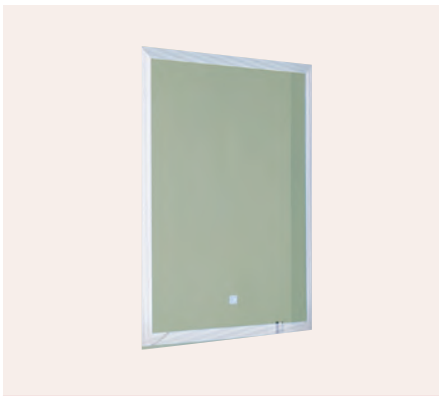

Ettrick

407



Fabriano

407



Findhorn

408



Klosters

408



Langton

409

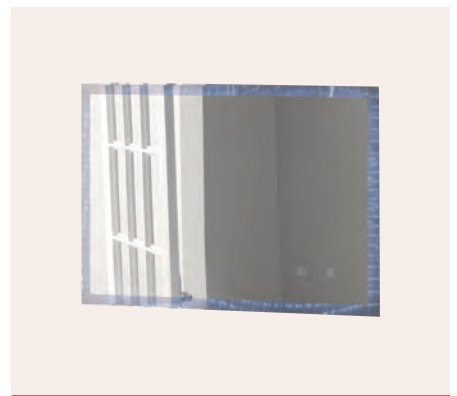

Leven

409

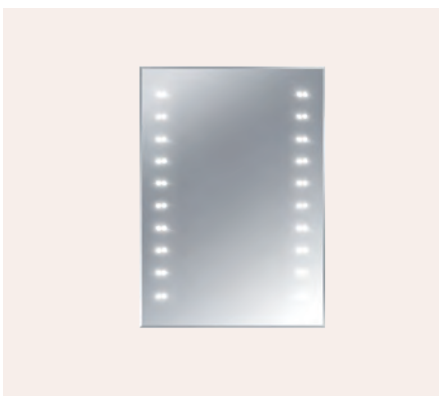

LED Lights

410

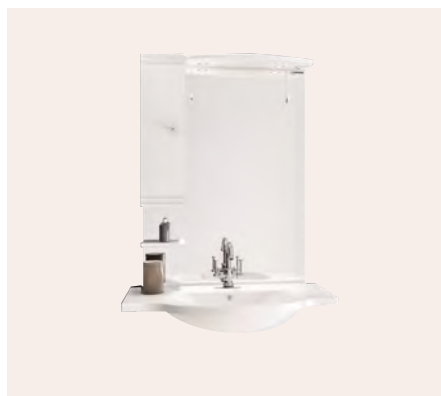

Madrid

403

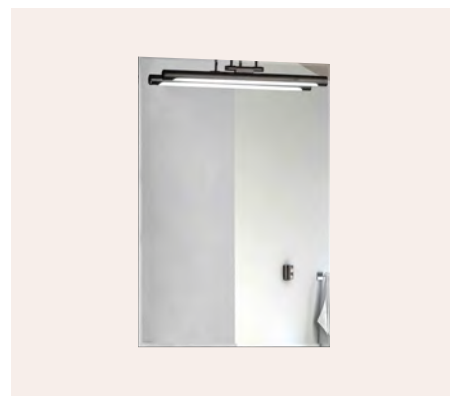

Ovado

410

Mirrors

LED Light Mirrors

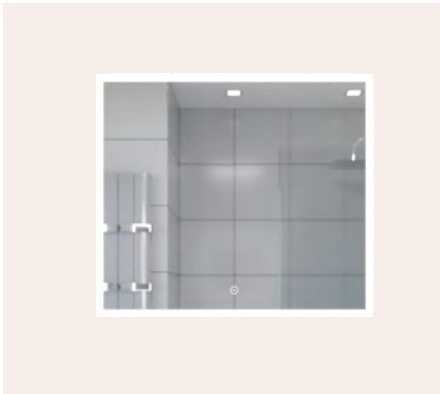

Pegella

411

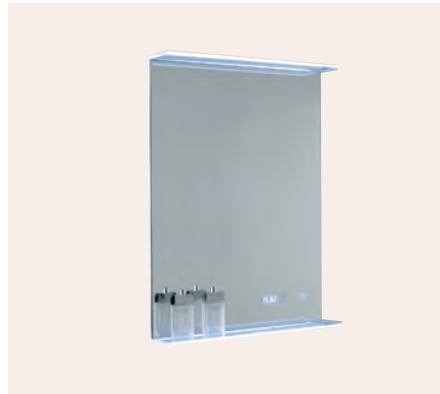

Spey

412



Treviso

412

Florescent Light Mirrors



Sorrento

404

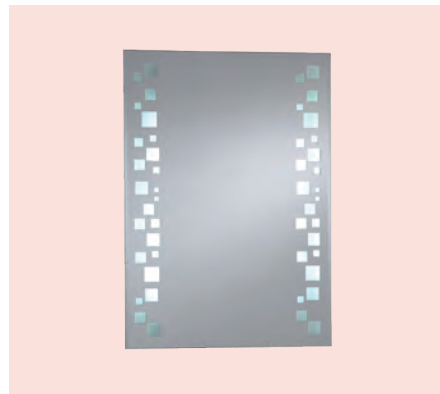

Charleston

413



Oslo Cabinets

400



Faro

405

Vanity Mirrors



Round frosted LED

392



Square LED

392

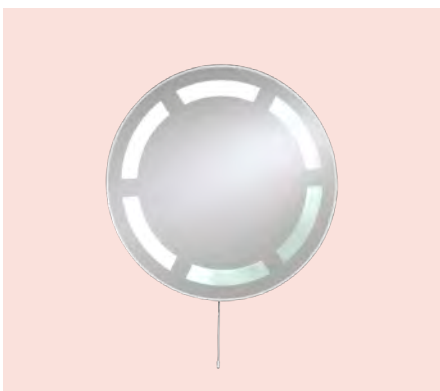

Rockland

413



Round LED

392

Shower Enclosures

Sliding Door Enclosures



Height 1850mm 6mm Glass

Volente Double Sliding Door P417
1200, 1400, 1500, 1600,
1700, 1800, 2000mm



Height 1850mm 6mm Glass

Vantage P442
1000, 1100, 1200, 1400,
1600, 1650, 1700mm



Height 1950mm 8mm Glass

Corniche P446
1000, 1100, 1200, 1400,
1600, 1700mm



Height 2000mm 10mm Glass

Vanguard P450-451
1000, 1100, 1200, 1400,
1600, 1700mm



Height 1850mm 6mm Glass

Volente In-line Sliding Door P420-421
1300, 1400, 1500, 1700mm



Height 1850mm 6mm Glass

Volente/Frosted Sliding Door P418-419
1000, 1100, 1200, 1300,
1400, 1500, 1600, 1700,
1800, 2000mm



Height 1850mm 5mm Glass

Vulcan P437
1000, 1100, 1200, 1300,
1400, 1500, 1600, 1700mm

Offset Quadrant



Height 1850mm 6mm Glass

Volente In-line P423
900x1200mm



Height 1850mm 6mm Glass

Volente Single Door P427
900x760/800mm
1000x760/800/900mm
1200x760/800/900mm



Height 2000mm 10mm Glass

Vanguard P453
1000x800mm
1200x800/900mm



Height 950mm 8mm Glass

Corniche P449
900x760/800mm
1000x760/800/900mm
1200x800/900mm



Height 1850mm 6mm Glass

Volente SpaceSaver P428-429
1000x850/650mm
1200x880/700mm
1650x912/700mm



Height 1850mm 6mm Glass

Vantage P444
900x760/800mm
1000x760/800/900mm
1100x760/800/900mm
1200x760/800/900mm
1300x760/800mm
1400x760/800mm



Height 1850mm 6mm Glass

Volente P425
900x700mm
1000x700/800/900mm
1100x700/760/800/900mm
1200x700/800/900mm
1300x760/800mm
1400x760/800mm

Shower Enclosures

Hinge/Pivot Door



Height 950mm 8mm Glass
Corniche Hinge Door P447
 700, 760, 800, 900, 1000mm



Height 1850mm 6mm Glass
Volente Hinge Door/Frosted P430-431
 700, 760, 800, 900, 1000mm



Height 1850mm 5mm Glass
Vulcan Hinge P436
 700/760/800/900/1000mm



Height 1850mm 6mm Glass
Volente Curved Corner P424
 1200 x 800mm



Height 1850mm 6mm Glass
Volente Double Hinge Door P434
 800x800mm
 900x760/800/900mm
 1000x760/800/900/1000mm
 1200x800/900mm



Height 1850mm 6mm Glass
Vantage Pivot Door P439
 700/760/800/900/1000mm



Height 1850mm 6mm Glass
Volente Frameless P416
 700/760/800/900/1000mm

Quadrant



Height 1850mm 6mm Glass
Vantage Quad P440-441
 800, 900, 1000mm



Height 1850mm 6mm Glass
Volente Quad Single Door P426
 800, 900, 1000mm



Height 2000mm 10mm Glass
Vanguard Quad P452
 800, 900, 1000mm



Height 1850mm 6mm Glass
Volente Quad P422
 800, 900, 1000mm



Height 1850mm 5mm Glass
Vulcan Quad P435
 800, 900mm



Height 950mm 8mm Glass
Corniche Quad P448
 800, 900, 1000mm

Corner Entry

Vantage Corner and Offset Corner Entry P442
 900x700/760/800mm
 1000x760/800mm



Height 1850mm 6mm Glass

Shower Enclosures

Bi-fold Doors



Height 1850mm 5mm Glass
Vantage P445
 700, 760, 800, 900, 1000mm



Height 1850mm 6mm Glass
Volente P432
 700, 760, 800, 900, 1000mm



Height 1850mm 5mm Glass
Vulcan Bi-fold P438
 700, 760, 800, 900mm



Height 1850mm 6mm Glass
Volente Bi-fold Inline P433
 1000, 1060, 1100, 1200, 1300mm

Walk-in Enclosures



Height 1950mm 8mm Glass
Valliant Round Pole Walk-in P466
 500, 700, 760, 800, 900, 1000, 1200, 1400mm



Height 1950mm 8mm Glass
Valliant Square Pole Walk-in P466
 500, 700, 760, 800, 900, 1000, 1200, 1400mm



Height 1850mm 6mm Glass
Curved Walk-in P461
Front panels: 870 for 1400mm, 970 for 1500mm
End panels: 900mm



Height 1950mm 6mm Glass
Vantage Flipper P465
Front panels: 600, 800, 900, 1100mm
End panels: 700, 760, 800, 900mm



Height 1950mm 8mm Glass
Corniche P464
Front panels: 850, 950, 1150mm
End panels: 700, 760, 800, 900mm



Height 1850mm 6mm Glass
Volente/Frosted P462-63
Front panels: 500, 700, 760, 800, 900, 1000, 1200mm
End panels: 300, 500, 700, 760, 800, 900mm



Height 1850mm 6mm Glass
Valliant Square Pole Walk-in Offset P468
 1000, 1100, 1200, 1300, 1400mm



Height 1850mm 6mm Glass
Valliant Round Pole Walk-in Offset P469
 1000, 1100, 1200, 1300, 1400mm



Height 1950mm 8mm Glass
Valliant P454-460
Front panels: 600, 700, 760, 800, 900, 1000, 1100, 1200mm
End panels: 300, 500, 700, 760, 800, 900, 1000mm



Height 2000mm 8mm Glass
Valliant Round Pole with Handhold P467
 800, 900, 1000, 1200mm

Panels & Trays

Side Panels



Height 1850mm 5mm Glass

Vulcan P436
700, 760, 800, 900, 1000mm



Height 1850mm 6mm Glass

Volente P416
700, 760, 800, 900, 1000mm



Height 1950mm 8mm Glass

Corniche with Towel Rail P446
700, 760, 800, 900, 1000mm

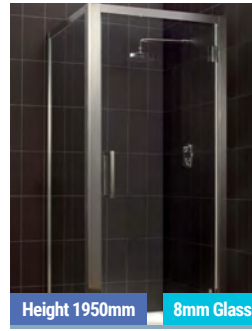

Height 1950mm 8mm Glass

Corniche P446
700, 760, 800, 900, 1000mm



Height 1850mm 6mm Glass

Vantage with Towel Rail P442
700, 760, 800, 900, 1000mm



Height 1850mm 6mm Glass

Vantage P442
700, 760, 800, 900, 1000mm



Height 2000mm 10mm Glass

Vanguard P451
700, 760, 800, 900, 1000mm

The Biava Wet Floor System

Biava Wet Floor System

P470-471



Trays

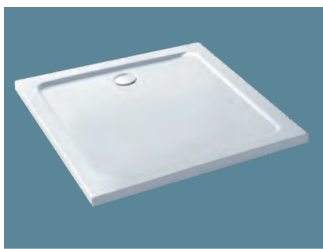

Volente Square Shower Trays P472



Volente Quadrant Shower Trays P473

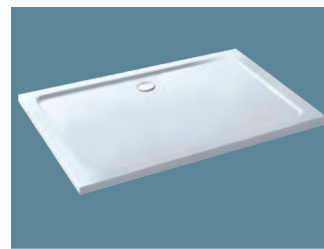

Volente Rectangular Shower Trays P475

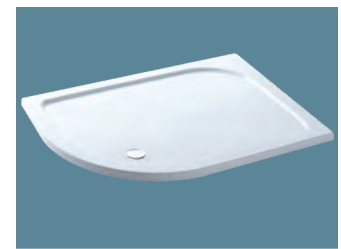

Volente Offset Quadrant Shower Trays P476-477

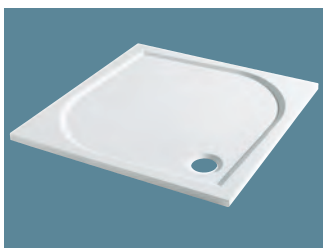

Vanguard Square Shower Trays P479

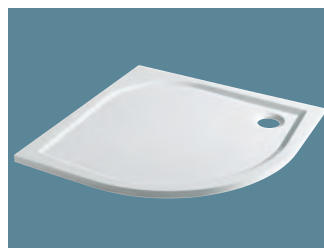

Vanguard Quadrant Shower Trays P478

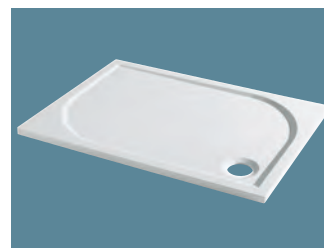

Vanguard Rectangular Shower Trays P479

Panels

Hydropanel Shower Panels

c-lenda jets - now available for immediate delivery on stocked whirlpools. Only 1mm protrusion from bath. Controls now on the inside vertical of the bath leaving the bath ledge clutter-free.

Hydropanel Shower Panels

P482-483

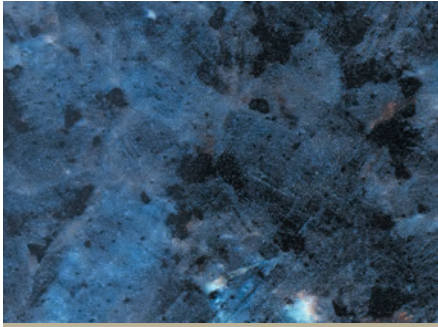

Pacific Blue Granite Gloss



New Marble White Gloss

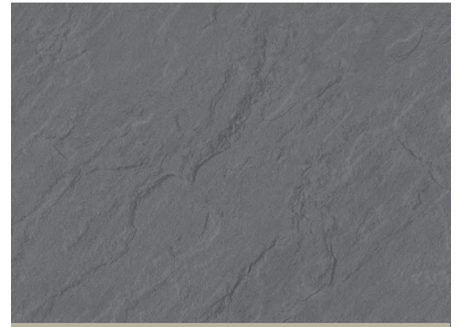

Slate Matt



Black Leaf



Marble Cream Gloss



White Speckle

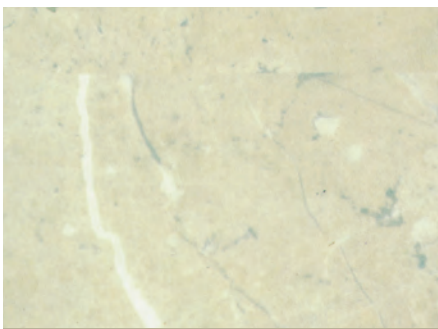

Marble Cream Gloss



New Marble Blue Gloss

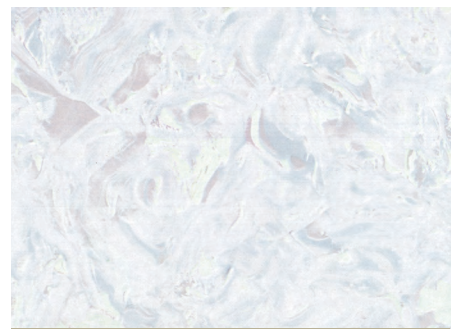

Mother Of Pearl Gloss



Black Speckle



Pebbles



Granite Gloss

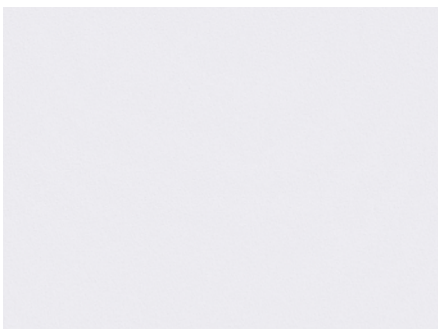

White Gloss

Panels

PVC Wide Panel

Ideal for walls and ceilings in bathrooms, showers and kitchens.

PVC Wide Panels P490-491



Travertine Gloss

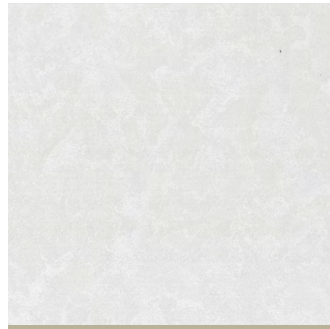

Pearl White



Black Sparkle



Concrete Beige Matt

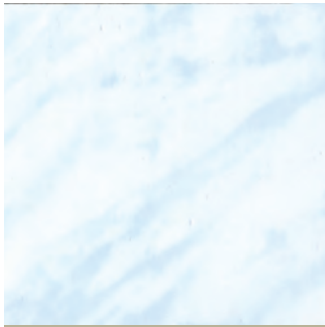

Marble Blue

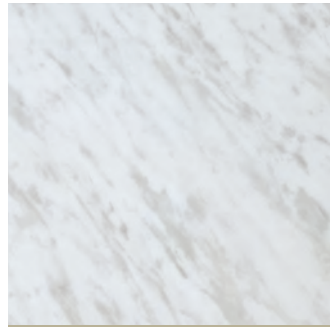

Carrara Marble

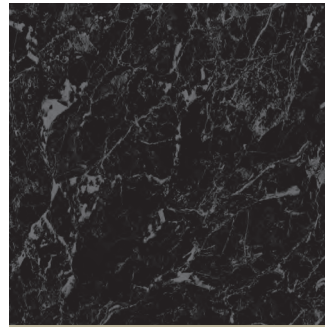

Black Marble Gloss



Mother Of Pearl



Marble Cream

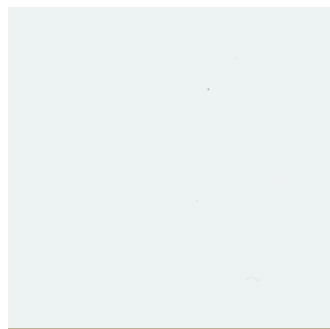

White



White Sparkle

PVC Ceiling & Wall Panelling

Standard Ceiling & Wall Panels P489

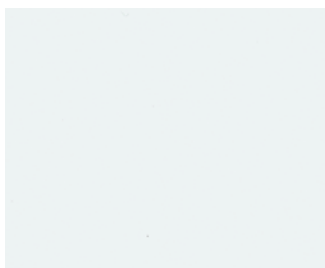

White

Mirror Gloss Hydro Panel

Mirror Gloss P486

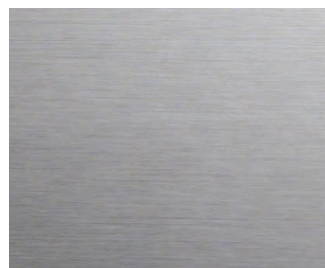

Mirror Gloss Brushed Aluminium



Mirror White Gloss



Mirror Gloss Black

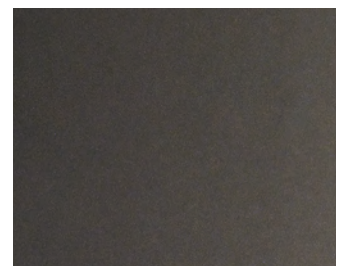

Mirror Gloss Anthracite

Towel Rails & Radiators

MULTIRAIL RANGE P494-524



Wendover Straight
P495



Wendover Straight
P494



Wendover Curved
P496-497



Wendover Straight
P498



Wendover Curved
P499



Wendover Straight
P500



Tuscan
P501



Wingrave Straight
P502-503

Please ask your local showroom or installer for a radiator **colour swatch** to match your preferred colour.



Wingrave Straight
P504-505



Wingrave Straight
P506-509



Wingrave Curved
P510-511



Biava Multirail Straight
P512-513



Biava Multirail Curved
P514-515



Biava Dry Element Straight
P516-517



Biava High Output Straight
P518



Biava Round
P519

Towel Rails & Radiators

MULTIRAIL RANGE

P494-524



Westward Straight
P521



Westward Straight
P520-521



Biava Double Tube On Tube
P523



Biava Tube On Tube
P522



Biava Square
P524

RADIATOR KEY Directional Size Availability



Horizontal
Sizes



Vertical
Sizes

DESIGNER RANGE

P525-563



Leonardo
P525



Hurley Towel Rail
P526-527



Hurley Towel Rail
P526-527



Staverton Tube On Tube Straight
P528



Staverton Tube On Tube Curved
P529



Staverton
P530



Mezzo Tondo
P531



Pesaro
P531

Towel Rails & Radiators

DESIGNER RANGE **P525-563**



Termoli
P532



Vieste
P532



Biava Corinium
P533



Rubin
P533



Marlow Towel Rail
P534-535



Marlow Towel Rail
P534-535



Ryton Towel Rail
P536-537



Kenilworth Towel Rail
P538-539



Loxley Towel Rail
P540-541



Eshton Towel Rail
P542-543



Rubano Vertical & Horizontal
P544-545



Rowsham Vertical & Horizontal
P546-547

Please ask your local showroom or installer for a radiator **colour swatch** to match your preferred colour.



Tunstall Vertical
P548-549



Tunstall Horizontal
P550



Tunstall Towel Rails
P551



Tunstall Towel Rails
P551

Towel Rails & Radiators

DESIGNER RANGE

P525-563

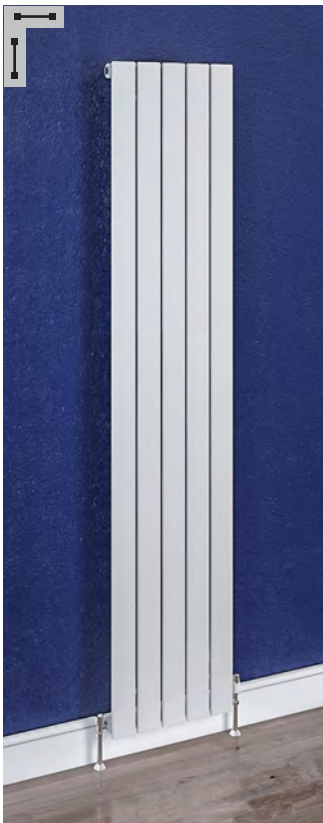

Addington Type 10 Radiator
P552-553

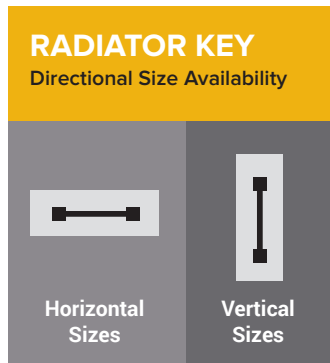

Addington Type 22 Radiator
P559



Addington Type 20 Radiator
P556-557



Addington Type 21 Radiator
P558



Claxton
P562



Weston
P563



Addington Type 10 Towel Rail
P555



Addington Type 20 Towel Rail
P560



Addington Type 21 Towel Rail
P561

ALUMINIUM RANGE

P564-612



Velor Straight
P564-565



Rosano Vertical
P566-567

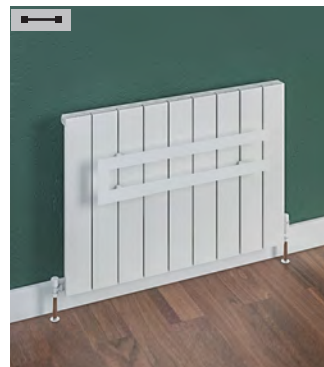

Rosano Horizontal
P568-569



Rosano Horizontal
P568-569

Towel Rails & Radiators

ALUMINIUM RANGE

P564-612



Peretti Vertical
P572-573



Peretti Horizontal
P574-575



Guardia Vertical
P578-579

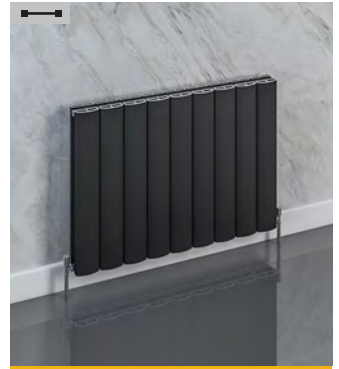

Guardia Horizontal
P580-581



Vesima Vertical
P582-583

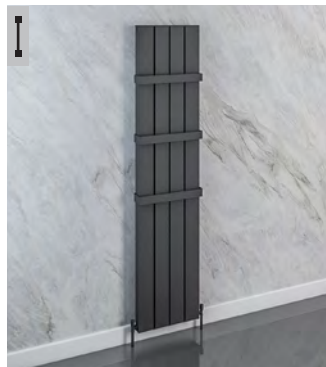

Vesima Vertical
P582-583

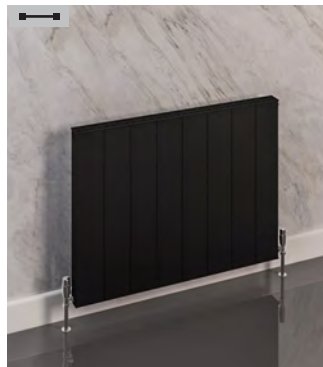

Vesima Horizontal
P584



Preston
P585

Please ask your local showroom or installer for a radiator **colour swatch** to match your preferred colour.



Berlin
P586-587



Berlin
P586-587



Charlton
P588-589



Withington
P591



Malmesbury Vertical
P594-595



Malmesbury Vertical
P594-595



Malmesbury Horizontal
P596-597



Malmesbury Horizontal
P596-597

Towel Rails & Radiators

ALUMINIUM RANGE

P564-612



Fairford Vertical
P600-601



Fairford Vertical
P600-601



Fairford Horizontal
P602-603



Burford Vertical
P604-605



Burford Horizontal
P606-607



Kelmscott Vertical
P608-609



Kelmscott Horizontal
P610-611



Witney Vertical
P612

STAINLESS STEEL RANGE

P613-615



Rizano
P613



Ascona
P613



Biava Flat
P614



Violla
P615



Violla
P615

RADIATOR KEY Directional Size Availability



Horizontal
Sizes



Vertical
Sizes

Towel Rails & Radiators

TRADITIONAL RANGE

P616-627



Windrush
P616

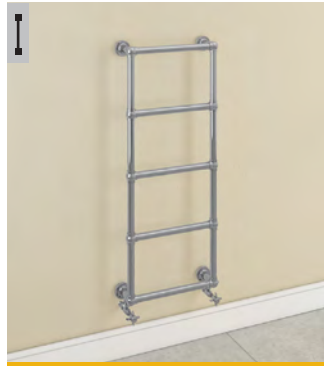

Stour
P617



Painswick
P618



Frome
P619



Ampney
P619



Sherbourne
P620



Severn
P620



Isbourne
P621

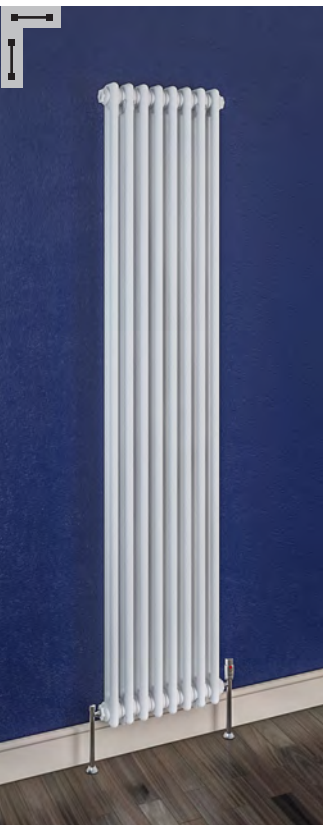

Rivassa 2 Column
P622-623



Rivassa 3 Column
P624-625



Isbourne
P621



Avon
P621



Rivassa 2 Column
P622-623



Rivassa 3 Column
P624-625

Please ask your local showroom or installer for a radiator **colour swatch** to match your preferred colour.

Towel Rails & Radiators

TRADITIONAL RANGE

P616-627



Thames
P626



Twyver
P627



Coln
P627



Leadon
P626

RADIATOR KEY

Directional Size Availability



Horizontal
Sizes



Vertical
Sizes



ACCESSORIES

P628-639

Vent Caps
P631



Elements
P628-629



Towel Hangers
P635-636

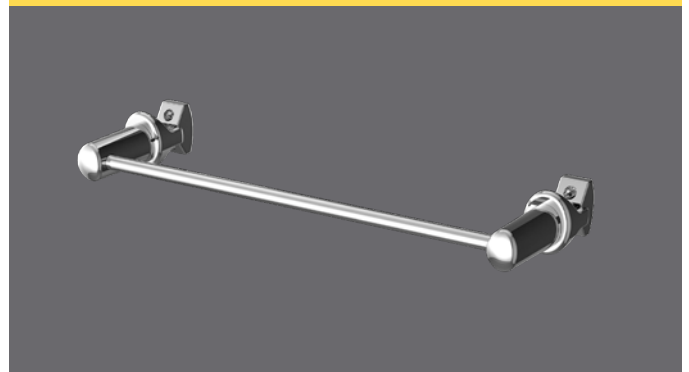

Manual Valves
P630-631



Thermostatic Radiator Valves
P632-634



Robe Hooks
P636



Bespoke RAL Colours
P638



Bespoke Sizes
P639



Showering

Shower Bundles & Valves

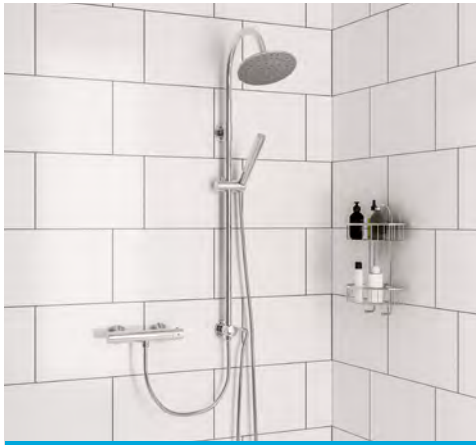

Shower Bundles

P642-645



Shower Valves

P646-649



Push Button Shower Valves

P650-651

Concealed / Exposed Shower Valves



Concealed / Exposed Shower Valves

P653-656

Bath Shower



Bath Shower Mixers

P651

Horizontal



Horizontal Shower Valves

P652

Poles

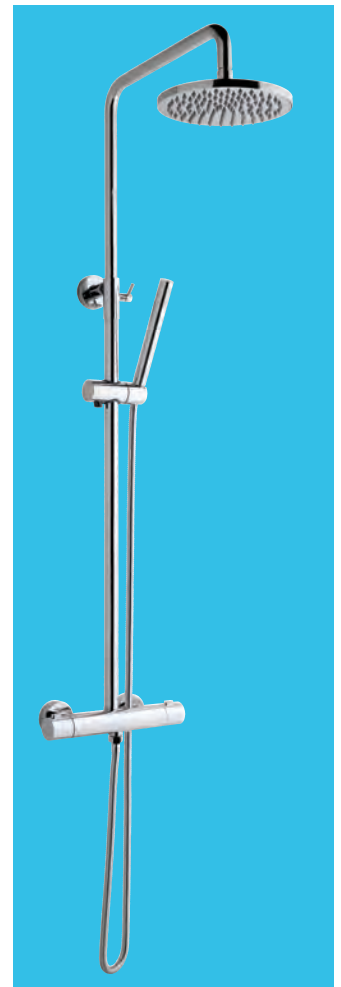

Shower Shelf



Luxury Shower Shelf

P659

Shower Arms

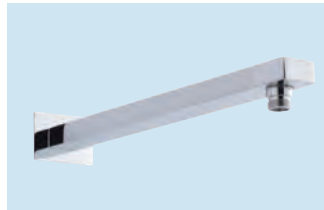
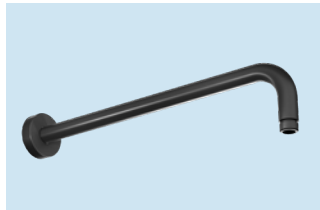

Shower Arms

P672-673

Riser Kit Accessories

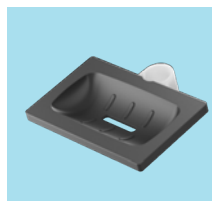
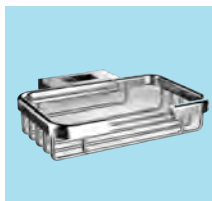
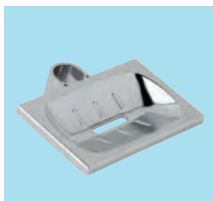

Riser Kit Accessories

P663-666

Showering

Riser Kits

662-667



Needle P664

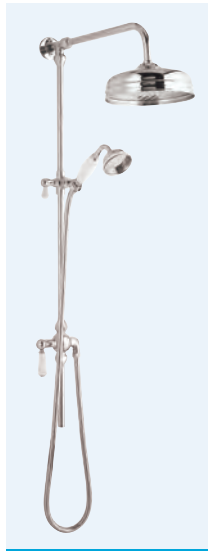

Victorian P657



Conway P665



Winslade P661



Winterbourne P661



Breeze P664



Memphis P662



3 in 1 Body Jets P665

Shower Heads & Hand Sets

667-673

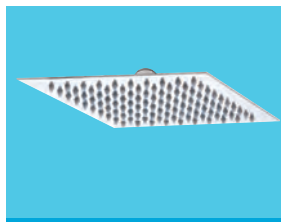

Rectangular & Square Fixed Heads

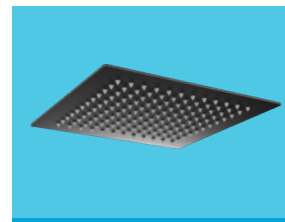

P674

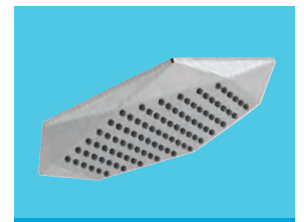

Type 40 Shower Head P651



Type 25 Shower Head P675



Hand Sets 668-670



Traditional Fixed Head P675

Bar Valves



Bar Valves



Traditional Rose & Arm P675



LED Handsets P667



Round Fixed Heads P674

Body Jets & Shower Seat

Wall Mounted Shower Heads



Body Jets

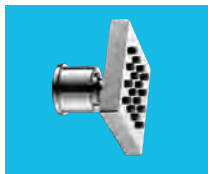

P677

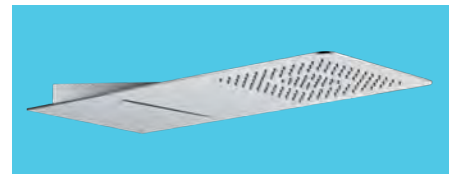

Wall Mounted Shower Heads with Waterfall

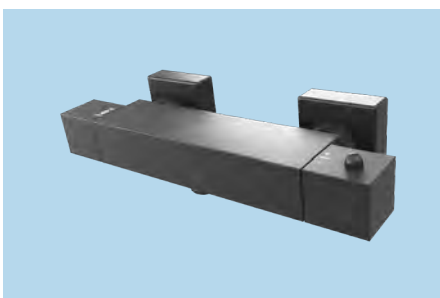

Shower Seat

P677

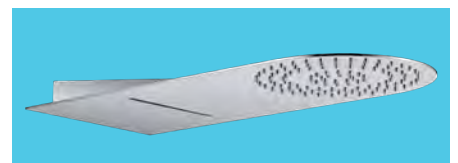

P671

Taps



Biava Hi-Flow P706



Biava Mini P693



Camborne P691



Diorama P704



Estorick P703



Side Valves P680



Wendover P692



Firth P704



Haymarket P711



Hooper P705



Isbourne P699



Kenton P713



Leith P708



Helston P694-697



Linslade P706



Portobello P710



Prestwood P707



Stenhouse P712



Tec Range P698



Cortauld P702



Newlyn P709



Thermostatic Shower Mixer P709



Vivande P705



Walton P700

Taps



Vivande P705



Walton P700



Westbourne P701



Falmouth P692



Winchester P702



Wingrave P701



Winchcombe P700

Kitchen Taps



Kitchen Taps P713



Hayle P698

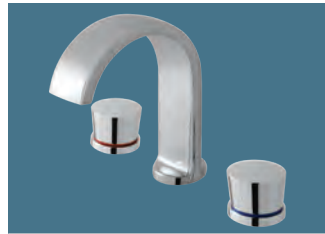

Albermarle P703

Prado Range

610-619



Prado 100 P690



Prado 300 P691



Prado 500 P686



Prado 550 P689



Prado 580 P687



Prado 600 P682



Prado 650 P687



Prado 700 P688



Prado 800 P690



Prado Lever P685



Prado Star P683



Prado Cylinder P684



Baths

From modern, contemporary minimalist style baths to those encompassing the most luxurious and traditional statements.

Contents

1200 and 1400mm baths	46-47
1500 and 1600mm baths	47-60
1700, 1800 and 1900mm baths	61-95
Showerbaths and screens	96-121
Freestanding baths	122-126
Offset baths	127-130
Corner baths	131-133



Strength & Beauty



UNIQUE DESIGN

Carronite™ baths have a unique support system; this has been designed to cope with the additional weight of the Carronite™ material. Once installed, the bath's stability and rigidity prevent movement, thus offering the perfect solution to the problem of sealing.

AMAZINGLY STRONG

They are demonstrably stronger than standard acrylic baths and have the same tensile strength as a steel bath. This is based on measuring the extent to which a cut section of a bath will bend when a 1kg weight is attached to it. A standard bath will bend to 56mm and the Carronite™ bath will bend to 45mm.

RETAIN HEAT

They will retain heat for approximately 20 minutes longer than a standard acrylic bath. This is based on a starting temperature of 55 degrees Celsius and reducing to 45 degrees Celsius.

Carronite™ samples available

INDUSTRY STANDARD

These test results are the reason that more industry professionals would recommend a Carronite™ bath over any other currently available.



HOW DOES CARRONITE™ WORK?

Carronite is an advanced reinforcement applied to Carron acrylic baths, developed and patented by Carron Bathrooms. A Carron bath reinforced with Carronite is capable of withstanding far greater stresses than a conventional acrylic bath. After a bath has been reinforced with Carronite, it has a strength and rigidity normally associated with a cast iron or heavy gauge steel bath, while enjoying all the benefits in finish, design and ease of care of modern acrylic baths.

The demonstrable strength of a Carronite™ bath comes from a unique triple layer reinforcement system. This additional weight means the bath requires to be fitted with a unique cradle support system. The combination of the material itself and the cradle system ensure the rigidity and stability of the bath.



ACRYLIC

Warm, durable, high gloss, easy clean finish, formed from 5mm acrylic.

Carronite™

High technology, rigid reinforcement.

18mm Baseboard

Totally encapsulated for total rigidity.

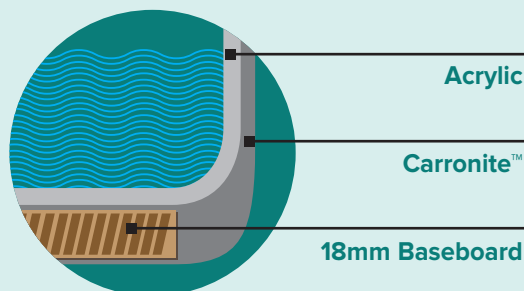

Strength & Beauty

SIX CARRONITE BATHS EASILY TAKE THE WEIGHT OF A TRI-AXLE TRACTOR UNIT.

MADE IN BRITAIN



FOUR CARRONITE BATHS EASILY TAKE THE WEIGHT OF A 7 1/2 TONNE VAN.



Why choose Carronite™?

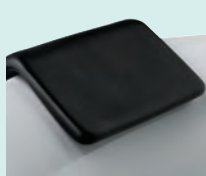

84.0001

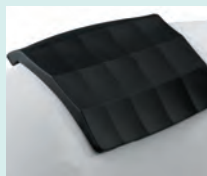

84.0000



Optional headrests available on some baths - look at the features boxes



- **Amazing strength**

The Carronite™ reinforcement can be applied to any Carron bath or panel making them stronger than any other conventional acrylic bath or panel available on the market

- **Unique installation**

Properly installed, a Carronite™ bath can last a lifetime

- **Enhanced insulation**

Due to the superior qualities of the Carronite™ material the water in the bath stays warmer for longer

- **Great designs**

Every bath in our range is available in the Carronite™ specification, providing customers with a wide range of designs to suit every bathroom

- **Traditional craftsmanship**

Carronite™ was developed and patented by Carron Bathrooms, a company with 250 years of experience in the design and manufacturing of premium quality products

- **Proven track record**

Carronite™ has a proven track record in the luxury hotel business where design and durability are essential

- **30 year manufacturer's warranty**

Every Carronite™ bath is backed by a 30 year manufacturer's warranty, offering you valuable peace of mind



1200 & 1400

URBAN SIT BATH

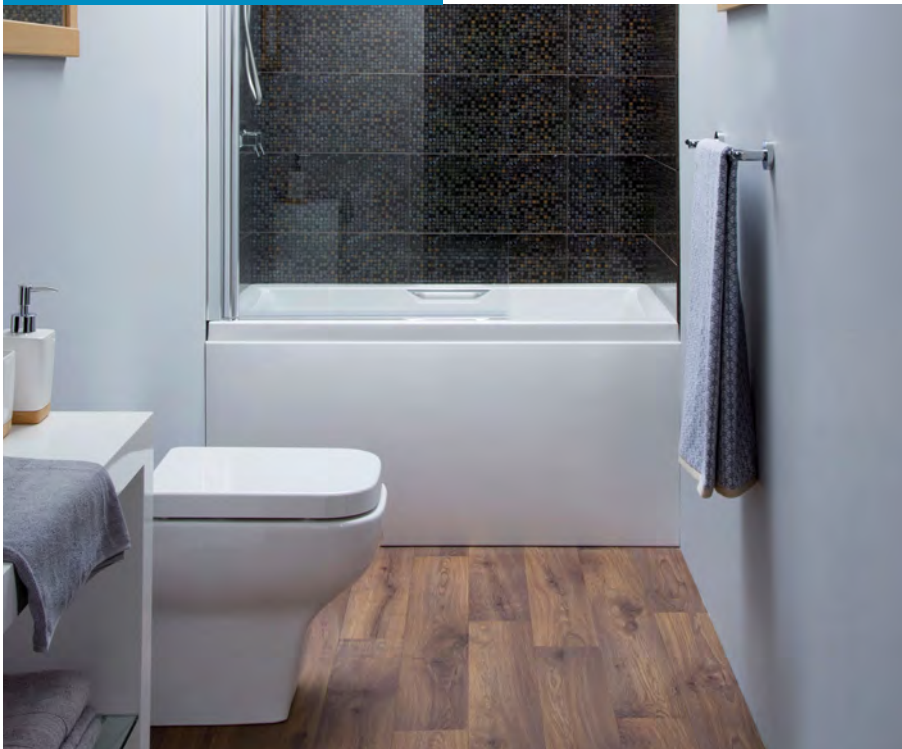

The sit bath is the perfect solution to the problem of comfortable bathing in a limited space. Its elegant, petite design will grace any bathroom. Taps can only be fitted to the side of bath.

1250 x 725 x 450mm		155 Litres	
Description	Code	£ Ex VAT	£ Inc VAT
1250 x 725 TG 5mm	23.0065	290.00	348.00
1250 x 725 Carronite	23.2065	459.00	550.80

PANELS

Front Panel 1250 x 540	23.1024	107.00	128.40
Front Panel 1250 x 540 Carronite	23.1025	138.00	165.60
725 x 540 end panel 5mm	23.3421	76.00	91.20
725 x 540 end panel C/nite	23.3431	100.00	120.00

FEATURES

- No tap holes or waste fittings
- Carronite baths have a 30 year guarantee

Head-rests available for all baths



Description	Code	£ Ex VAT	£ Inc VAT
Universal foam headrest	84.0001	28.00	33.60
Universal PU Gel Headrest	84.0000	55.00	66.00

- Shower
- Grips
- Head Rest

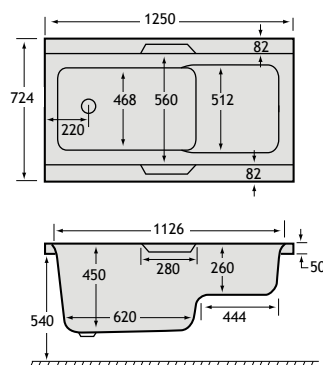

DELTA 1400

- Shower
- Whirl Pool
- Grips
- Head Rest



The up-to-the-minute simplicity of line and form lend timeless appeal to Carron's latest designer range. Comfortably proportioned, the Delta offers width and depth that invite you to indulge in a long, de-stressing soak.

1400 x 700 x 410mm		142 Litres	
Description	Code	£ Ex VAT	£ Inc VAT
1400 x 700 5mm	23.0701	291.00	349.20
1400 x 700 Carronite	23.2701	528.00	633.60
1400 x 700 TG 5mm	23.4211	332.00	398.40
1400 x 700 TG Carronite	23.5211	569.00	682.80
Headrest HR800	23.312	106.00	127.20

PANELS

Front Panel 1400 x 515	23.1028	96.00	115.20
Carronite Panel 1400 x 515	23.1034	138.00	165.60
Universal end panel 700 x 515	23.1611	76.00	91.20
Carronite panel 700 x 515	23.1421	100.00	120.00

Also available in the Delta range:
1500 (P48), 1600 (P53), 1650 (P58),
5'6" (P59), 1700 (P62)



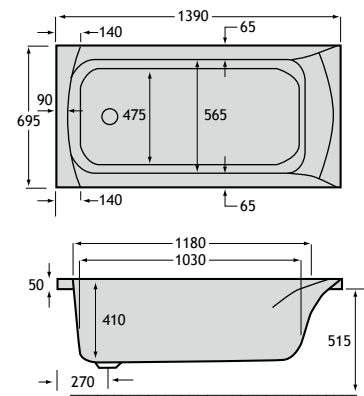

FEATURES

- Available with chrome twin grips
- Bespoke whirlpool available
- No tap holes or waste fittings
- Suitable for showering
- Carronite baths have a 30 year guarantee



1400 & 1500

IMPERIAL 1400

- Shower 
- Whirl Pool 
- Grips 
- Head Rest 



Designed for locations where space is at a premium, this stylish bath maximises the bathing area available.

1400 x 700 x 400mm 135 Litres

Description	Code	£ Ex VAT	£ Inc VAT
1400 TG 5mm	23.0041	222.00	266.40
1400 TG Carronite	23.2041	413.00	495.60
Headrest HR800	23.312	106.00	127.20

PANELS

Front Panel 1400 x 515	23.1028	96.00	115.20
Quantum C/nite panel 1400 x 515	23.1034	138.00	165.60
Universal end panel 700 x 515	23.1611	76.00	91.20
Carronite panel 700 x 515	23.1421	100.00	120.00

Also available in the Imperial range:
1500 (P49), 1600 (P53),
5'6" (P60), 1700 (P63), 1800 (P86)

FEATURES

- Full length textured base
- Optional headrest available
- Bespoke whirlpool available
- No tap holes or waste fittings
- Suitable for showering
- Carronite baths have a 30 year guarantee

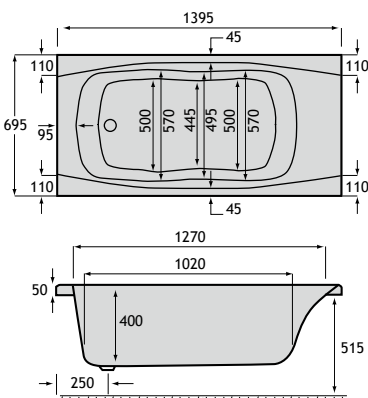

ADVANTAGE DEEP BATH

- Shower 



Right hand version shown

A deep, space saving bath which allows a compromise between the ease of showering and the luxury of bathing.

1500 x 700/800 x 500mm 242 Litres

Description	Code	£ Ex VAT	£ Inc VAT
1500 x 800 5mm LH	23.4861L	555.00	666.00
1500 x 800 5mm RH	23.4861R	555.00	666.00
1500 x 800 Carronite LH	23.5861L	822.00	986.40
1500 x 800 Carronite RH	23.5861R	822.00	986.40

PANELS

Panel for Advantage deep bath LH	23.3481L	123.00	147.60
Panel for Advantage deep bath RH	23.3481R	123.00	147.60
Advantage showerscreen 6mm Easyclean	58.712	194.00	232.80
Volente 1000 4 fold screen	58.700	131.00	157.20
Volente 1250 5 fold screen	58.701	162.00	194.40

*This bath has a suspended panel

FEATURES

- Easy clean glass shower screen
- No tap holes or waste fittings
- Suitable for showering
- Carronite baths have a 30 year guarantee

Left hand version shown

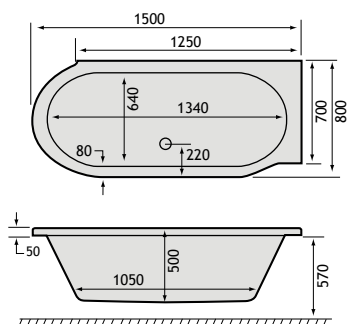

Right hand shown



58.701 screen

1500

ARC SINGLE ENDED 1500

- Shower 
- Whirl Pool 



This newly designed single ended bath has a wide curved end for comfort and luxury in bathing with plenty of space for showering.

1500 x 700 x 400mm		150 Litres	
Description	Code	£ Ex VAT	£ Inc VAT
1500x700 5mm	23.4591	213.00	255.60
1500x700 Carronite	23.5591	408.00	489.60

PANELS

L shaped C/nite 1700x700x515*	23.3571	273.00	327.60
Quantum Front Panel 1500x515	23.3231	96.00	115.20
Quantum C/nite 1500x515	23.3281	138.00	165.60
Universal end panel 700x515	23.1611	76.00	91.20
Carronite panel 700 x 515	23.1421	100.00	120.00

*This panel needs to be cut down.



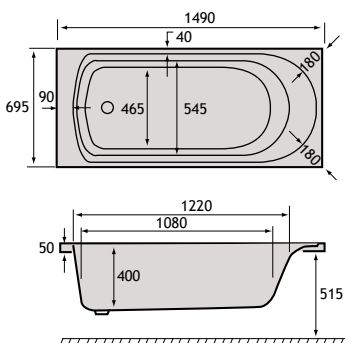

Also available in the Arc single-ended range: 1700 x 700 (P61), 1700 x 750 (P75)

FEATURES

- Bespoke whirlpool available
- No tap holes or waste fittings
- Suitable for showering
- Carronite baths have a 30 year guarantee



AXIS 1500

- Shower 
- Grips 
- Eco 
- Low Level 
- Head Rest 



This low level easy access bath is based on the design of the Classic shower bath. Due to its low level it makes an excellent bath and shower bath for the less mobile. Also available in 1600 and 1700.

1500 x 700 x 400mm		131 Litres	
Description	Code	£ Ex VAT	£ Inc VAT
1500 x 700 plain 5mm	23.4451	227.00	272.40
1500 x 700 plain Carronite	23.5451	426.00	511.20
1500 x 700 TG 5mm	23.4531	257.00	308.40
1500 x 700 TG Carronite	23.5531	456.00	547.20
Headrest HR800	23.312	106.00	127.20

PANELS

L shaped C/nite 1500x700x430	23.1016	273.00	327.60
Quantum panel 1500x430	23.1037	96.00	115.20
Quantum C/nite panel 1500x430	23.1038	138.00	165.60
Universal end panel 700x430	23.1771	76.00	91.20
C/nite end panel 700x430	23.1811	100.00	120.00

*This panel needs to be cut down.





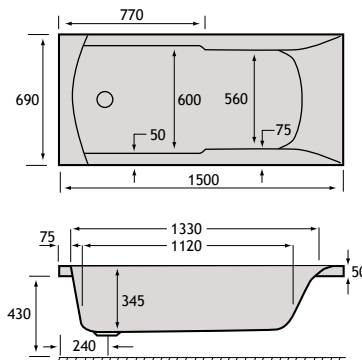

Also available in the Arc single-ended range: 1700 x 700 (P61), 1700 x 750 (P75)

FEATURES

- Low level - easy access
- Available with chrome twin grips
- Water saving - just 131 litres
- No tap holes or waste fittings
- Suitable for showering
- Optional headrest available
- Carronite baths have a 30 year guarantee



DELTA 1500

- Shower 
- Whirl Pool 
- Grips 
- Eco 
- Low Level 
- Head Rest 



The up-to-the-minute simplicity of line and form lend timeless appeal to Carron's latest designer range. Comfortably proportioned, the Delta offers width and depth that invite you to indulge in a long, de-stressing soak.

1500 x 700 x 410mm		152 Litres	
Description	Code	£ Ex VAT	£ Inc VAT
1500 x 700 5mm	23.0711	291.00	349.20
1500 x 700 Carronite	23.2711	528.00	633.60
1500 x 700 TG 5mm	23.4221	332.00	398.40
1500 x 700 TG Carronite	23.5221	569.00	682.80
Headrest HR800	23.312	106.00	127.20

PANELS

L shaped C/nite 1700x700x515*	23.3571	273.00	327.60
Quantum Front Panel 1500x515	23.3231	96.00	115.20
Quantum C/nite 1500x515	23.3281	138.00	165.60
Universal end panel 700x515	23.1611	76.00	91.20
Carronite panel 700 x 515	23.1421	100.00	120.00

*This panel needs to be cut down.

Also available in the Delta range: 1400 (P46), 1600 (P53), 1650 (P58), 5'6" (P59), 1700 (P62)

FEATURES

- Available with chrome twin grips
- Bespoke whirlpool available
- No tap holes or waste fittings
- Suitable for showering
- Carronite baths have a 30 year guarantee

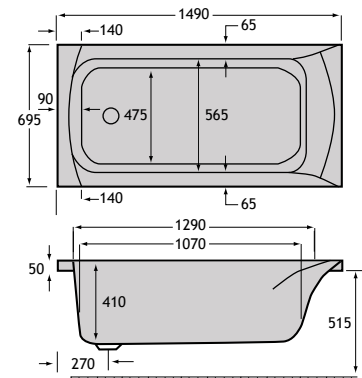

IMPERIAL 1500



A very practical option when replacing old imperial baths. Features full length textured base.

1500 x 700 x 400mm		145 Litres	
Description	Code	£ Ex VAT	£ Inc VAT
1500x700 5mm	23.0171	222.00	266.40
1500x700 Carronite	23.2171	413.00	495.60
1500x700 5mm	23.312	106.00	127.20

PANELS

L shaped C/nite 1700x700x515*	23.3571	273.00	327.60
Quantum Front Panel 1500x515	23.3231	96.00	115.20
Quantum C/nite 1500x515	23.3281	138.00	165.60
Universal end panel 700x515	23.1611	76.00	91.20
Carronite panel 700 x 515	23.1421	100.00	120.00

*This panel needs to be cut down.

Also available in the Imperial range: 1400 (P47), 1600 (P53), 5'6" (P60), 1700 (P63), 1800 (P86)

FEATURES

- Chrome twin grips
- Bespoke whirlpool available
- No tap holes or waste fittings
- Optional headrest available
- Carronite baths have a 30 year guarantee
- Full length textured base

Head-rests available for all baths



Description	Code	£ Ex VAT	£ Inc VAT
Universal foam headrest	84.0001	28.00	33.60
Universal PU Gel Headrest	84.0000	55.00	66.00

Whirl Pool



Grips



Head Rest

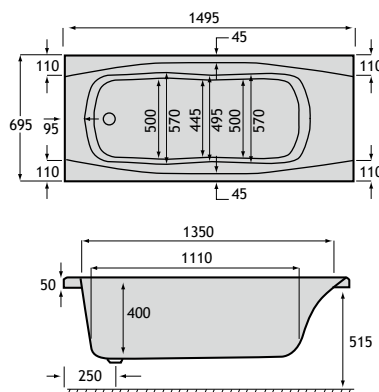

MATRIX 1500

Shower



Grips



Eco



Head Rest



The Matrix is identical to the Axis but with a standard leg pack. Ideal bath for showering with the addition of shower screen.

1500 x 700 x 345mm		131 Litres	
Description	Code	£ Ex VAT	£ Inc VAT
1500 x 700 plain 5mm	23.4521	227.00	272.40
1500 x 700 plain Carronite	23.5521	426.00	511.20
1500 x 700 5mm TG	23.4461	257.00	308.40
1500 x 700 Carronite TG	23.5461	456.00	547.20
Headrest HR800	23.312	106.00	127.20

PANELS

L shaped C/nite 1700x700x515*	23.3571	273.00	327.60
Quantum Front Panel 1500x515	23.3231	96.00	115.20
Quantum C/nite 1500x515	23.3281	138.00	165.60
Universal end panel 700x515	23.1611	76.00	91.20
Carronite panel 700 x 515	23.1421	100.00	120.00

*This panel needs to be cut down.

Also available in the Matrix range: 1600 (P54), 1700 (P64)

FEATURES

- Available with chrome twin grips
- Water saving - just 131 litres
- No tap holes or waste fittings
- Suitable for showering
- Optional headrest available

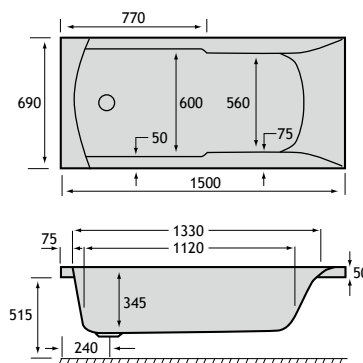

1500

PROFILE 1500

- Shower
- Head Rest



A modern bath with a 33mm ledge on three sides for a sleek minimalist look and optimum bathing space.

1500 x 700 x 400mm		190 Litres	
Description	Code	£ Ex VAT	£ Inc VAT
Profile 1500x700 5mm	23.0037	261.00	313.20
Profile 1500x700 Cnite	23.2037	484.00	580.80

PANELS

L shaped C/nite 1700x700x515*	23.3571	273.00	327.60
Quantum Front Panel 1500x515	23.3231	96.00	115.20
Quantum C/nite 1500x515	23.3281	138.00	165.60
Universal end panel 700x515	23.1611	76.00	91.20
Carronite panel 700 x 515	23.1421	100.00	120.00

BATH SCREENS

Corniche 8mm 800x1400	69.0142	212.00	254.40
Volente 6mm 850x1500	58.702	158.00	189.60
Volente 8mm 850x1500	58.703	163.00	195.60

*This panel needs to be cut down.

Also available in the Profile range:
1600 x 700 (P54), 1700 x 700/750 (P65/77)

FEATURES

- No tap holes or waste fittings
- Carronite baths have a 30 year guarantee
- Optional headrest available

QUANTUM INTEGRA ECO LOW LEVEL

- Shower
- Grips
- Eco
- Low Level
- Head Rest



Taking the popular Quantum range to a new level with sleek integrated grips for added security and low level for easy access.

1500 x 700 x 345mm		152 Litres	
Description	Code	£ Ex VAT	£ Inc VAT
Quantum Integra 1500 x 700 Eco TG 5mm	23.0048	263.00	315.60
Quantum Integra 1500 x 700 Eco TG Carronite	23.2048	458.00	549.60
HR900 Headrest	23.309	106.00	127.20

PANELS

L shaped C/nite 1500x700x430	23.1016	273.00	327.60
Quantum Panel 1500 x 430	23.1037	96.00	115.20
Quantum Panel C/nite 1500 x 430	23.1038	138.00	165.60
Axis 700 end panel	23.1771	76.00	91.20
Axis 700 Carronite end panel	23.1811	100.00	120.00

Also available in the Quantum Integra Eco range:
1600 (P55), 1700 (P67)

FEATURES

- Chrome twin grips
- Optional headrest available
- Low level - easy access
- No tap holes or waste fittings
- Carronite baths have a 30 year guarantee

QUANTUM INTEGRA ECO STANDARD HEIGHT

- Shower
- Grips
- Eco
- Head Rest



Taking the popular Quantum range to a new level with sleek integrated grips for added security and low level for easy access.

1500 x 700 x 345mm		152 Litres	
Description	Code	£ Ex VAT	£ Inc VAT
Quantum Integra 1500 x 700 Eco TG 5mm	23.6036	263.00	315.60
Quantum Integra 1500 x 700 Eco TG Carronite	23.6039	458.00	549.60
HR900 Headrest	23.309	106.00	127.20

PANELS

L shaped C/nite 1500x700x430	23.1016	273.00	327.60
Quantum Panel 1500 x 430	23.1037	96.00	115.20
Quantum Panel C/nite 1500 x 430	23.1038	138.00	165.60
Axis 700 end panel	23.1771	76.00	91.20
Axis 700 Carronite end panel	23.1811	100.00	120.00

Also available in the Quantum Integra Eco range:
1600 (P55), 1700 (P67)

FEATURES

- Chrome twin grips
- Optional headrest available
- Low level - easy access
- No tap holes or waste fittings
- Carronite baths have a 30 year guarantee

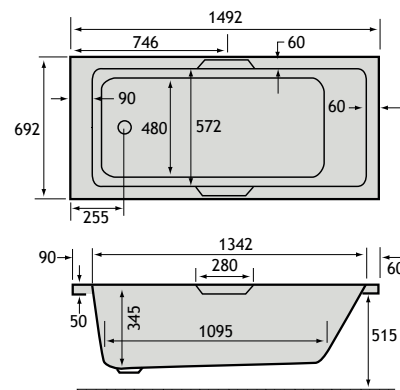
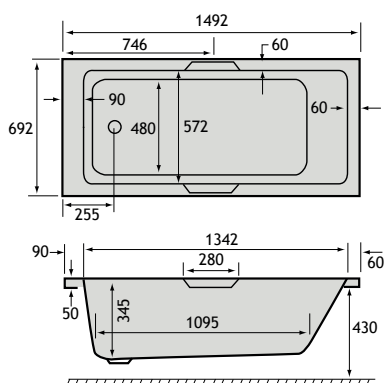
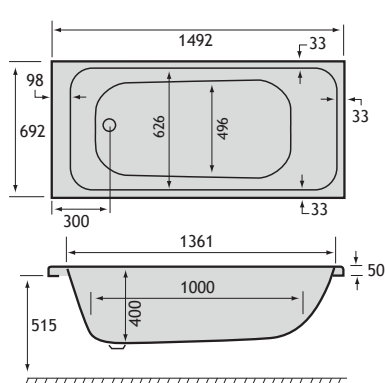

QUANTUM SINGLE ENDED 1500

- Shower 
- Whirl Pool 
- Head Rest 



This newly designed single ended bath with straight sides and minimalist lines maximising both bathing and showering space.

1500 x 700 x 410mm	198 Litres		
Description	Code	£ Ex VAT	£ Inc VAT
1500 x 700 5mm	23.4641	227.00	272.40
1500 x 700 Carronite	23.5641	428.00	513.60
HR900 Headrest	23.309	106.00	127.20

PANELS

L shaped C/nite 1700x700x515*	23.3571	273.00	327.60
Quantum Front Panel 1500x515	23.3231	96.00	115.20
Quantum C/nite 1500x515	23.3281	138.00	165.60
Universal end panel 700x515	23.1611	76.00	91.20
Carronite panel 700 x 515	23.1421	100.00	120.00

*This panel needs to be cut down.

Also available in the Quantum range:
 1600 x 700/800 (P55/57),
 1700 x 700/750/800/900 (P66/78/82/84),
 1800 x 725 (P86), 1800 x 800 (P92)

FEATURES

- Bespoke whirlpool available
- No tap holes or waste fittings
- Suitable for showering
- Carronite baths have a 30 year guarantee
- Optional headrest available

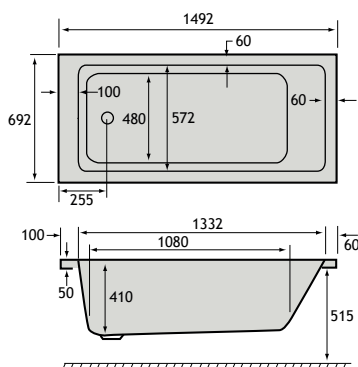

QUANTUM SINGLE ENDED INTEGRA



Combining the added safety and security that comes with a gripped bath, with the sleek, modern lines of the existing Quantums. The Integra features an integrated grip that has been designed to complement the original Quantum design.

1500 x 700 x 410mm	198 Litres		
Description	Code	£ Ex VAT	£ Inc VAT
Quantum Integra 1500 x 700 TG 5mm	23.4991	263.00	315.60
Quantum Integra 1500 x 700 TG C/nite	23.5991	458.00	549.60
HR900 Headrest	23.309	106.00	127.20

PANELS

L shaped C/nite 1700x700x515*	23.3571	273.00	327.60
Quantum Front Panel 1500x515	23.3231	96.00	115.20
Quantum C/nite 1500x515	23.3281	138.00	165.60
Universal end panel 700x515	23.1611	76.00	91.20
Carronite panel 700 x 515	23.1421	100.00	120.00

BATH SCREENS

Corniche 8mm 800x1400	69.0142	212.00	254.40
Volente 6mm 850x1500	58.702	158.00	189.60
Volente 8mm 850x1500	58.703	163.00	195.60





*This panel needs to be cut down.

Also available in the Quantum Integra range:
 1600 x 700 (P56), 1650 x 700 (P59)
 1700 x 700/750/800 (P68/79/81),
 1800 x 800 (P92)

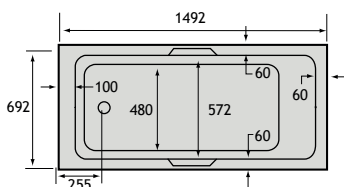
FEATURES

- Carronite baths have a 30 year guarantee
- No tap holes or waste fittings
- Stylish twin chrome gripped bath
- Bespoke whirlpool available
- Suitable for showering



- Shower 
- Whirl Pool 
- Grips 
- Head Rest 



Head-rests available for all baths



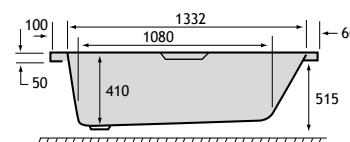

Description	Code	£ Ex VAT	£ Inc VAT
Universal foam headrest	84.0001	28.00	33.60
Universal PU Gel Headrest	84.0000	55.00	66.00



1575 & 1600

SWING



- Shower 
- Whirl Pool 
- Head Rest 



Left hand shown

A uniquely designed bath with a wide luxurious ledge just right for a relaxing glass of wine.

Swing 1575 x 850 x 420mm		225 Litres	
Description	Code	£ Ex VAT	£ Inc VAT
Swing RH 1575x850 Cnite	23.2045R	849.00	1018.80
Swing LH 1575x850 Cnite	23.2045L	849.00	1018.80
Quantum screen	58.4000	245.00	294.00
Quantum screen with towel rail 1400mm	69.0141	331.00	397.20
Quantum Type 1 Screen*	58.4001	325.00	390.00

PANELS

Swing L shaped panel carronite	23.1014	276.00	331.20
Swing Front Panel 5mm	23.1007	96.00	115.20
Swing Front Panel Carronite	23.1008	138.00	165.60

*Taps must be mounted left or right of screen wall profile.

Also available without the ledge. See Urban Edge shower bath page 102

FEATURES

- No tap holes or waste fittings
- Carronite baths have a 30 year guarantee
- Suitable for showering
- Bespoke whirlpool available

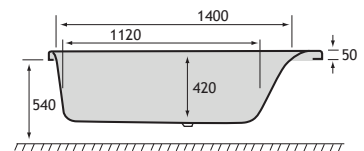
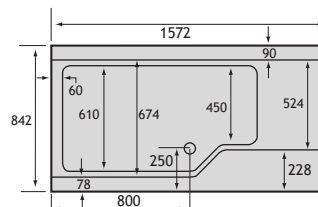

AXIS 1600

This low level easy access bath is based on the design of the Classic shower bath. Due to its low-level it makes an excellent bath and shower bath for the less mobile.





1600 x 700 x 345mm		138 Litres	
Description	Code	£ Ex VAT	£ Inc VAT
1600 x 700 plain 5mm	23.4471	227.00	272.40
1600 x 700 plain Carronite	23.5471	426.00	511.20
1600 x 700 TG 5mm	23.4551	257.00	308.40
1600 x 700 TG Carronite	23.5551	456.00	547.20
Headrest HR800	23.312	106.00	127.20

PANELS

L Shaped C/nite 1600x700x430	23.1017	273.00	327.60
Quantum panel 1600 x 430	23.1039	96.00	115.20
Quantum panel C/nite 1600 x 430	23.1040	138.00	165.60
700 end panel	23.1771	76.00	91.20
700 Carronite end panel	23.1811	100.00	120.00

Also available in the Axis range: 1500 x 700 (P48), 1700 x 700 (P61)



- Shower 
- Grips 
- Eco 
- Low Level 
- Head Rest 

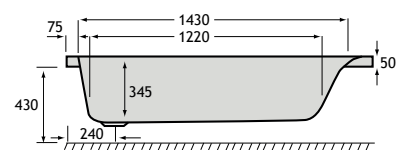
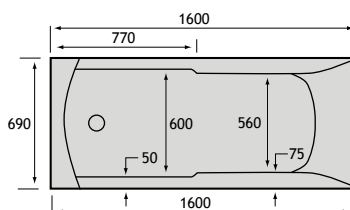





FEATURES

- Available with chrome twin grips
- Water saving - just 138 litres
- Low level - easy access
- Suitable for showering

- No tap holes or waste fittings
- Carronite baths have a 30 year guarantee
- Optional headrest available

DELTA 1600



- Shower 
- Whirl Pool 
- Grips 
- Head Rest 



The up-to-the-minute simplicity of line and form lend timeless appeal to Carron's latest designer range. Comfortably proportioned, the Delta offers width and depth that invite you to indulge in a long, de-stressing soak.

1600 x 700 x 410mm		162 Litres	
Description	Code	£ Ex VAT	£ Inc VAT
1600 x 700 5mm	23.0721	291.00	349.20
1600 x 700 Carronite	23.2721	528.00	633.60
TG 1600 x 700 5mm	23.4231	332.00	398.40
TG 1600 x 700 Carronite	23.5231	569.00	682.80
Delta 1600 x 700 5mm	23.312	106.00	127.20

PANELS

L shaped C/nite 1700x700x515	23.3571*	273.00	327.60
Quantum panel 1600x515	23.3241	96.00	115.20
Quantum C/nite 1600x515	23.3291	138.00	165.60
Universal end panel 700x515	23.1611	76.00	91.20
Carronite end panel 700x515	23.1421	100.00	120.00

*This panel needs to be cut down.

The Delta range includes:

Delta 1400 x 700	See page 46
Delta 1500 x 700	See page 48
Delta 1600 x 700	See this page
Delta 1650 x 700	See page 58
Delta 5'6"	See page 59
Delta 1700 x 700	See page 62

FEATURES

- Available with chrome twin grips
- Bespoke whirlpool available
- Optional headrest available
- Suitable for showering
- No tap holes or waste fittings
- Carronite baths have a 30 year guarantee

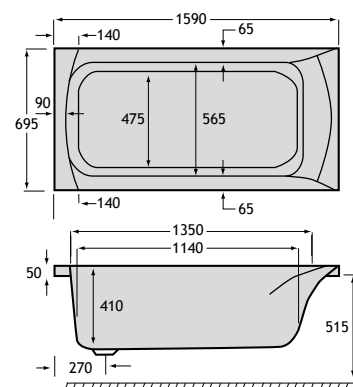

IMPERIAL 1600

A practical option when replacing old 1600 baths, complete with grips and features full length textured base.

1600 x 700 x 400mm		162 Litres	
Description	Code	£ Ex VAT	£ Inc VAT
1600 x 700 TG 5mm	23.4161	222.00	266.40
1600 x 700 TG Carronite	23.5161	413.00	495.60
Headrest HR800	23.312	106.00	127.20





PANELS

L shaped C/nite 1700x700x515*	23.3571	273.00	327.60
Quantum panel 1600x515	23.3241	96.00	115.20
Quantum C/nite 1600x515	23.3291	138.00	165.60
Universal end panel 700x515	23.1611	76.00	91.20
Carronite end panel 700x515	23.1421	100.00	120.00

*This panel needs to be cut down.

Also available in the Imperial range: 1400 (P47), 1500 (P49), 5'6" (P60), 1700 (P63), 1800 (P86)



- Shower 
- Whirl Pool 
- Grips 
- Head Rest 

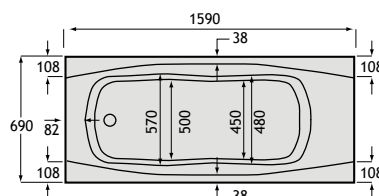





FEATURES

- Bespoke whirlpool available
- Optional headrest available
- Suitable for showering

- No tap holes or waste fittings
- Full length textured base
- Chrome grips

1600

MATRIX 1600

- Shower 
- Grips 
- Eco 
- Head Rest 



The Matrix is identical to the Axis but with a standard leg pack. Ideal bath for showering with the addition of a shower screen.

1600 x 700 x 345mm		138 Litres	
Description	Code	£ Ex VAT	£ Inc VAT
1600 x 700 plain 5mm	23.4541	227.00	272.40
1600 x 700 plain Carronite	23.5541	426.00	511.20
1600 x 700 TG 5mm	23.4481	257.00	308.40
1600 x 700 TG Carronite	23.5481	456.00	547.20
Headrest HR800	23.312	106.00	127.20

PANELS

L shaped C/nite 1700x700x515*	23.3571*	273.00	327.60
Quantum panel 1600x515	23.3241	96.00	115.20
Quantum C/nite 1600x515	23.3291	138.00	165.60
Universal end panel 700x515	23.1611	76.00	91.20
Carronite end panel 700x515	23.1421	100.00	120.00

*This panel needs to be cut down.

Also available in the Matrix range: 1500 (P49), 1700 (P64)

FEATURES

- Available with chrome twin grips
- Water saving - just 138 litres
- Optional headrest available
- Suitable for showering
- No tap holes or waste fittings
- Carronite baths have a 30 year guarantee

PROFILE 1600

- Shower 
- Head Rest 



A modern bath with a 33mm ledge on three sides for a sleek minimalist look and optimum bathing space.

1600 x 700 x 400mm		204 Litres	
Description	Code	£ Ex VAT	£ Inc VAT
Profile 1600x700 5mm	23.0038	261.00	313.20
Profile 1600x700 5mm	23.2038	484.00	580.80

PANELS

L shaped C/nite 1700x700x515*	23.3571	273.00	327.60
Quantum panel 1600x515	23.3241	96.00	115.20
Quantum C/nite 1600x515	23.3291	138.00	165.60
Universal end panel 700x515	23.1611	76.00	91.20
Carronite panel 700 x 515	23.1421	100.00	120.00

BATH SCREENS

Corniche 8mm 800x1400	69.0142	212.00	254.40
Volente 6mm 850x1500	58.702	158.00	189.60
Volente 8mm 850x1500	58.703	163.00	195.60

*This panel needs to be cut down.

Also available in the Profile range: 1500 x 700 (P50), 1700 x 700/750 (P65/77), 1800 x 700 (P87)

FEATURES

- No tap holes or waste fittings
- Carronite baths have a 30 year guarantee
- Optional headrest available

PROFILE DUO 1600

- Head Rest 



The modern Profile bath is now available in the double ended Duo. With a 35mm ledge on three sides, it still has the sleek minimalist look of the Profile. Also available in 1700 x 700/750.

1600 x 700 x 410mm		188 Litres	
Description	Code	£ Ex VAT	£ Inc VAT
Profile 1600x700 Duo 5mm	23.0055	261.00	313.20
Profile 1600x700 Duo C/nite	23.2055	484.00	580.80

PANELS



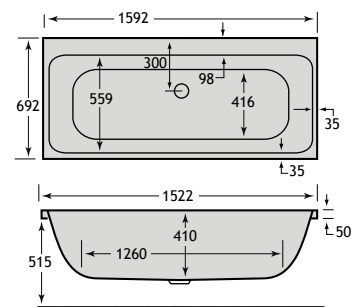
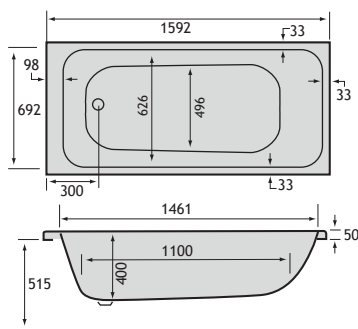
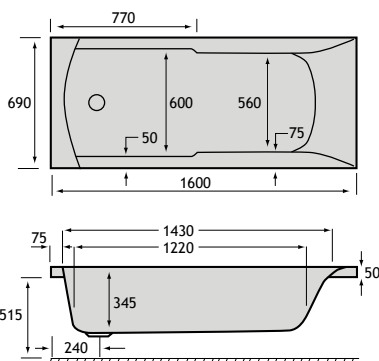

L shaped C/nite 1700x700x515*	23.3571	273.00	327.60
Quantum panel 1600x515	23.3241	96.00	115.20
Quantum C/nite 1600x515	23.3291	138.00	165.60
Universal end panel 700x515	23.1611	76.00	91.20
Carronite end panel 700x515	23.1421	100.00	120.00

*This panel needs to be cut down.

Also available in the Profile Duo range: 1650 x 700 (P58), 1700 x 700/750 (P66/77), 1800 x 700 (P87)



QUANTUM INTEGRA ECO LOW LEVEL

- Shower 
- Grips 
- Eco 
- Low Level 
- Head Rest 



Taking the popular Quantum range to a new level with sleek integral grips for added security and low level for easy access.

1600 x 700 x 345mm	161 Litres		
Description	Code	£ Ex VAT	£ Inc VAT
Quantum Integra Low Level Eco TG 5mm	23.0049	263.00	315.60
Quantum Integra Low Level 1600 x 700 Eco TG Carronite	23.2049	458.00	549.60
HR900 Headrest	23.309	106.00	127.20

PANELS

L shaped C/nite 1600x700x430	23.1017	273.00	327.60
Quantum panel 1600x430	23.1039	96.00	115.20
Quantum C/nite panel 1600x430	23.1040	138.00	165.60
Universal end panel 700x430	23.1771	76.00	91.20
Carronite end panel 700x430	23.1811	100.00	120.00

BATH SCREENS





Volente 6mm 850x1500	58.702	158.00	189.60
Volente 8mm 850x1500	58.703	163.00	195.60

Also available in the Quantum Integra Eco range: 1500 (P50), 1700 (P67)

FEATURES

- Chrome twin grips
- Optional headrest available
- Low level - easy access
- No tap holes or waste fittings
- Carronite baths have a 30 year guarantee

QUANTUM INTEGRA ECO STANDARD HEIGHT

- Shower 
- Grips 
- Eco 
- Head Rest 



Taking the popular Quantum range to a new level with sleek integral grips for added security.

1600 x 700 x 345mm	161 Litres		
Description	Code	£ Ex VAT	£ Inc VAT
Quantum Integra 1600 x 700 Eco TG 5mm	23.6037	263.00	315.60
Quantum Integra 1600 x 700 Eco TG Carronite	23.6040	458.00	549.60
HR900 Headrest	23.309	106.00	127.20

PANELS

L shaped C/nite 1700x700x515*	23.3571	273.00	327.60
Quantum panel 1600x515	23.3241	96.00	115.20
Quantum C/nite panel 1600x515	23.3291	138.00	165.60
Universal end panel 700x515	23.1611	76.00	91.20
Carronite end panel 700x515	23.1421	100.00	120.00

BATH SCREENS



Volente 6mm 850x1500	58.702	158.00	189.60
Volente 8mm 850x1500	58.703	163.00	195.60

Also available in the Quantum Integra Eco range: 1500 (P50), 1700 (P67)

FEATURES

- Chrome twin grips
- Optional headrest available
- No tap holes or waste fittings
- Carronite baths have a 30 year guarantee

QUANTUM SINGLE ENDED 1600

- Shower 
- Whirl Pool 
- Head Rest 



This newly designed single ended bath with straight sides and minimalist lines maximising both bathing and showering space.

1600 x 700 x 410mm	213 Litres		
Description	Code	£ Ex VAT	£ Inc VAT
1600 x 700 5mm	23.4651	227.00	272.40
1600 x 700 Carronite	23.5651	428.00	513.60
HR900 Headrest	23.309	106.00	127.20

PANELS

L shaped C/nite 1700x700x515*	23.3571	273.00	327.60
Quantum panel 1600x515	23.3241	96.00	115.20
Quantum C/nite 1600x515	23.3291	138.00	165.60
Universal end panel 700x515	23.1611	76.00	91.20
Carronite end panel 700x515	23.1421	100.00	120.00

*This panel needs to be cut down.

Also available in the Quantum range: 1500 x 700 (P51), 1600 x 800 (P57), 1700 x 700/750/800/900 (P66/78/82/84), 1800 x 725 (P86), 1800 x 800 (P92)

FEATURES

- Bespoke whirlpool available
- No tap holes or waste fittings
- Suitable for showering
- Carronite baths have a 30 year guarantee
- Optional headrest available

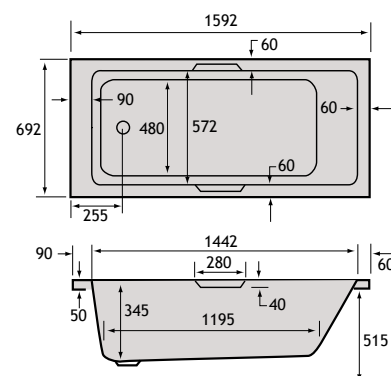
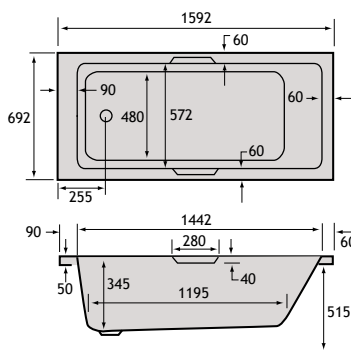
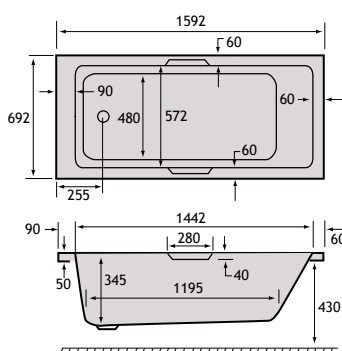

1600

QUANTUM SINGLE ENDED INTEGRA



Combining the added safety and security that comes with a gripped bath, with the sleek, modern lines of the existing Quantums. The Integra features an integrated grip that has been designed to complement the original Quantum design.

1600 x 700 x 410mm		213 Litres	
Description	Code	£ Ex VAT	£ Inc VAT
Quantum Integra 1600 x 700 TG 5mm	23.0015	263.00	315.60
Quantum Integra 1600 x 700 TG C/nite	23.2015	458.00	549.60
HR900 Headrest	23.309	106.00	127.20

PANELS

L shaped C/nite 1700x700x515*	23.3571	273.00	327.60
Quantum panel 1600x515	23.3241	96.00	115.20
Quantum C/nite 1600x515	23.3291	138.00	165.60
Universal end panel 700x515	23.1611	76.00	91.20
Carronite end panel 700x515	23.1421	100.00	120.00

BATH SCREENS

Corniche 8mm 800x1400	69.0142	212.00	254.40
Volente 6mm 850x1500	58.702	158.00	189.60
Volente 8mm 850x1500	58.703	163.00	195.60

*This panel needs to be cut down.

Also available in the Quantum Integra range: 1500 x 700 (P51), 1650 x 700 (P59), 1700 x 700/750/800 (P68/79/81), 1800 x 800 (P92)

FEATURES

- Carronite baths have a 30 year guarantee
- No tap holes or waste fittings
- Stylish twin chrome gripped bath
- Bespoke whirlpool available
- Suitable for showering

Head-rests available for all baths



Description	Code	£ Ex VAT	£ Inc VAT
Universal foam headrest	84.0001	28.00	33.60
Universal PU Gel Headrest	84.0000	55.00	66.00

Shower

Whirl Pool

Grips

Head Rest

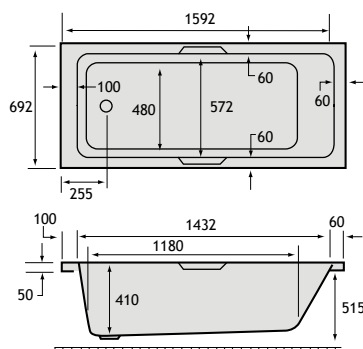

CAMDEN 1600

Shower

Head Rest



This newly designed single ended bath with straight sides and minimalist lines maximising both bathing and showering space.

1600 x 700 x 515mm		192 Litres	
Description	Code	£ Ex VAT	£ Inc VAT
1600 x 700 5mm	23.6020	261.00	313.20
1600 x 700 Carronite	23.6021	484.00	580.80

PANELS

L shaped C/nite 1700x700x515*	23.3571	273.00	327.60
Quantum panel 1600x515	23.3241	96.00	115.20
Quantum C/nite 1600x515	23.3291	138.00	165.60
Universal end panel 700x515	23.1611	76.00	91.20
Carronite end panel 700x515	23.1421	100.00	120.00

*This panel needs to be cut down.

Also available in the Camden range: 1650 x 700 (P58), 1700 x 700 (P61)

FEATURES

- No tap holes or waste fittings
- Suitable for showering
- Carronite baths have a 30 year guarantee
- Optional headrest available

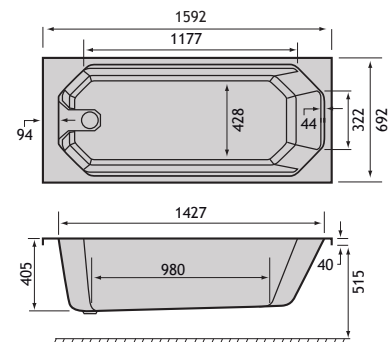

STATUS 1600



Left hand shown, bath to be fitted in a corner situation only. Taps for illustration purposes only.

Bringing a unique perspective to bathroom design, the Status adds a touch of luxury with its soft curves and ideal proportions. This bath has a suspended panel.

1600 x 725 x 425mm		197 Litres	
Description	Code	£ Ex VAT	£ Inc VAT
1600 x 725 RH 5mm	23.4801R	416.00	499.20
1600 x 725 LH 5mm	23.4801L	416.00	499.20
1600 x 725 RH Carronite	23.5801R	705.00	846.00
1600 x 725 LH Carronite	23.5801L	705.00	846.00

PANELS

Description	Code	£ Ex VAT	£ Inc VAT
1600 x 725 x 540 panel	23.3461	201.00	241.20
1600 x 725 x 540 Carronite panel	23.3561	270.00	324.00

*No bath screen available.

Also available in the Status range: Status showerbath 1550 x 850 (P101), 1700 x 725 (P69), 1700 x 800 (P83)

FEATURES

- Bespoke whirlpool available
- No tap holes or waste fittings
- Suitable for showering
- Carronite baths have a 30 year guarantee

Right hand shown

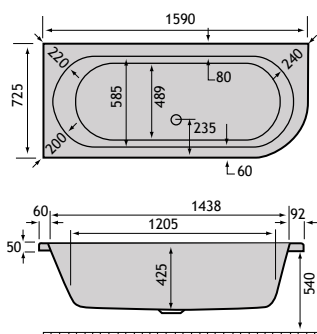

SIGMA 1600



A wider version of the Delta 1600.

1600 x 750 x 420mm		175 litres	
Description	Code	£ Ex VAT	£ Inc VAT
1600 x 750 5mm	23.4581	388.00	465.60
1600 x 750 Carronite	23.5581	624.00	748.80
1600 x 750 TG 5mm	23.4731	429.00	514.80
1600 x 750 TG Carronite	23.5731	665.00	798.00
Headrest HR800	23.312	106.00	127.20

PANELS

Description	Code	£ Ex VAT	£ Inc VAT
Quantum panel 1600x515	23.3241	96.00	115.20
Quantum C/nite 1600x515	23.3291	138.00	165.60
Carron universal end panel 750 x 515	23.1601	76.00	91.20
Carronite panel 750 x 515	23.3361	100.00	120.00

Also available in the Sigma range: 1700 x 750 (P79), 1700 x 800 (P82), 1800 (P93), 1900 (P95)

FEATURES

- Available with chrome twin grips
- Bespoke whirlpool available
- Suitable for showering

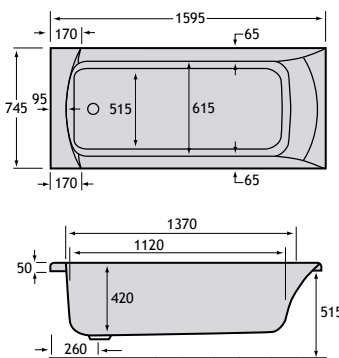

QUANTUM SINGLE ENDED 1600



This newly designed single ended bath with straight sides and minimalist lines maximising both bathing and showering space

1600 x 800 x 430mm		247 litres	
Description	Code	£ Ex VAT	£ Inc VAT
1600 x 800 5mm	23.4911	315.00	378.00
1600 x 800 Carronite	23.5911	506.00	607.20
HR900 Headrest	23.309	106.00	127.20

PANELS

Description	Code	£ Ex VAT	£ Inc VAT
Quantum panel 1600x540	23.3521	93.00	111.60
Quantum C/nite 1600x540	23.3531	138.00	165.60
Carron end panel 800 x 540	23.1641	76.00	91.20
Carronite panel 800 x 540	23.1451	96.00	115.20

Also available in the Quantum range: 1500 x 700 (P51), 1600 x 700 (P53), 1700 x 700/750/800/900 (P66/78/82/84), 1800 x 725 (P86), 1800 x 800 (P92)

FEATURES

- Bespoke whirlpool available
- No tap holes or waste fittings
- Suitable for showering
- Carronite baths have a 30 year guarantee
- Optional headrest available

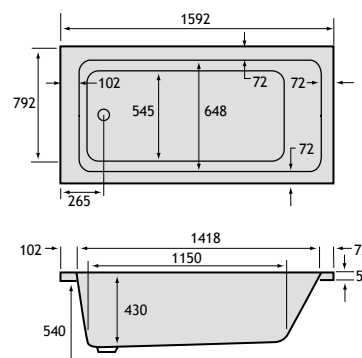

1600

CAMDEN 1650



Shower



Head Rest



This newly designed single ended bath with straight sides and minimalist lines maximising both bathing and showering space.

1650 x 700 x 515mm	200 Litres		
Description	Code	£ Ex VAT	£ Inc VAT
1650 x 700 5mm	23.6022	261.00	313.20
1650 x 700 Carronite	23.6023	484.00	580.80

PANELS

Quantum panel 1600x515	23.1029	96.00	115.20
Quantum C/nite 1600x515	23.1035	138.00	165.60
Universal end panel 700x515	23.1611	76.00	91.20
Carronite end panel 700x515	23.1421	100.00	120.00

*This panel needs to be cut down.

Also available in the Camden range:
1600 x 700 (P56), 1700 x 700 (P61)

FEATURES

- No tap holes or waste fittings
- Suitable for showering
- Carronite baths have a 30 year guarantee
- Optional headrest available

PROFILE DUO 1650



Head Rest



Taking the popular Profile range to a new level of luxury with a double ended option. Also available in 1600 and 1700 x 750.

1650 x 700 x 410mm	196 Litres		
Description	Code	£ Ex VAT	£ Inc VAT
1650 x 700 DE 5mm	23.0067	261.00	313.20
1650 x 700 DE Carronite	23.2067	484.00	580.80

PANELS

L shaped C/nite 1700x700x515*	23.3571*	273.00	327.60
Quantum panel 1600x515	23.1029	96.00	115.20
Quantum C/nite 1600x515	23.1035	138.00	165.60
Universal end panel 700x515	23.1611	76.00	91.20
Carronite end panel 700x515	23.1421	100.00	120.00

*This panel needs to be cut down.

Also available in the Profile Duo range:
1600 x 700 (P54), 1700 x 700/750 (P66/77) 1800 x 700 (P87)

FEATURES

- No tap holes or waste fittings
- Carronite baths have a 30 year guarantee
- Optional headrest available

DELTA 1650 (5'5")



Shower



Whirl Pool



Grips



Head Rest



Comfortably proportioned, the Delta offers width and depth that invite you to indulge in a long, de-stressing soak.

1650 x 700 x 410mm	196 Litres		
Description	Code	£ Ex VAT	£ Inc VAT
1650 x 700 plain 5mm	23.4441	291.00	349.20
1650 x 700 Carronite	23.5441	528.00	633.60
1650 x 700 TG 5mm	23.4561	332.00	398.40
1650 x 700 TG Carronite	23.5561	569.00	682.80
Headrest HR800	23.312	106.00	127.20

PANELS

L shaped C/nite 1700x700x515*	23.3571*	273.00	327.60
Quantum panel 1600x515	23.1029	96.00	115.20
Quantum C/nite 1600x515	23.1035	138.00	165.60
Universal end panel 700x515	23.1611	76.00	91.20
Carronite end panel 700x515	23.1421	100.00	120.00

*This panel needs to be cut down.

Also available in the Delta range:
1400 (P46), 1500 (P48), 1600 (P53), 5' 6" (P59), 1700 (P62),



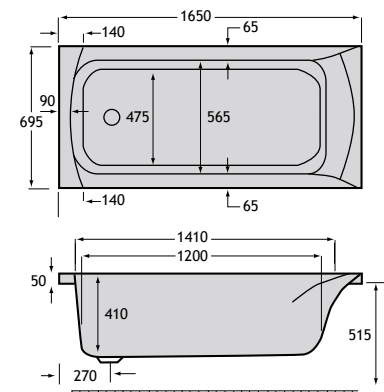
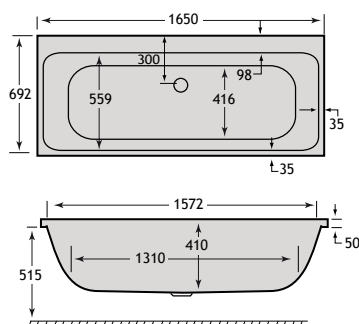
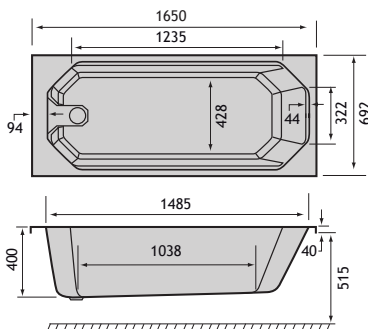

FEATURES

- Available with chrome twin grips
- Bespoke whirlpool available
- Optional headrest available



QUANTUM 1650 SINGLE ENDED INTEGRA



- Shower 
- Whirl Pool 
- Grips 
- Head Rest 

Combining the added safety and security that comes with a gripped bath, with the sleek, modern lines of the existing Quantums. The Integra features an integrated grip that has been designed to complement the original Quantum design.

1650 x 700 x 410mm	216 Litres		
Description	Code	£ Ex VAT	£ Inc VAT
1650 x 700 SE 5mm	23.0068	263.00	315.60
1650 x 700 SE Carronite	23.2068	458.00	549.60

PANELS

L shaped C/nite 1700x700x515	23.3571*	273.00	327.60
Quantum panel 1650x515	23.1029	96.00	115.20
Quantum Carronite 1650x515	23.1035	138.00	165.60
Universal end panel 700x515	23.1611	76.00	91.20
Carronite end panel 700x515	23.1421	100.00	120.00

*This panel needs to be cut down.

BATH SCREENS

Corniche 8mm 800x1400	69.0142	212.00	254.40
Volente 6mm 850x1500	58.702	158.00	189.60
Volente 8mm 850x1500	58.703	163.00	195.60

Also available in the Quantum SE Integra range:
1500 (P51), 1600 (P56), 1700 x 700/750/800 (P68/79/81), 1800 x 800 (P92)

FEATURES

- Chrome twin grips
- Bespoke whirlpool available
- Suitable for showering
- No tap holes or waste fittings
- Carronite baths have a 30 year guarantee

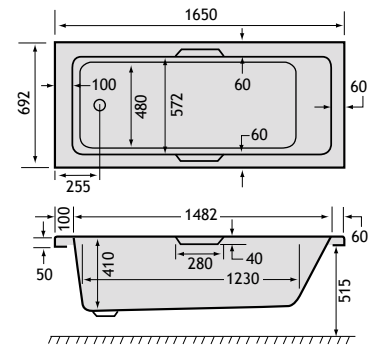

DELTA 5'6"

A genuine 5'6" bath - a practical option when replacing imperial baths.

1675 x 700 x 410mm	170 Litres		
Description	Code	£ Ex VAT	£ Inc VAT
5'6" Plain 5mm	23.4381	291.00	349.20
5'6" Plain Carronite	23.5381	528.00	633.60
5'6" TG 5mm	23.4391	332.00	398.40
5'6" TG Carronite	23.5391	569.00	682.80
Headrest HR800	23.312	106.00	127.20

PANELS





L shaped C/nite 1700x700x515	23.4381*	291.00	349.20
Quantum front panel 1675x515	23.1030	96.00	115.20
Carronite front panel 1675x515	23.1036	138.00	165.60
Universal end panel 700x515	23.1611	76.00	91.20
Carronite end panel 700x515	23.1421	100.00	120.00

*This panel needs to be cut down.

Also available in the Delta range:
1400 (P46), 1500 (P48), 1600 (P53),
1650 (P58), 1700 (P62),

FEATURES

- Available with chrome twin grips
- Bespoke whirlpool available
- Suitable for showering
- No tap holes or waste fittings
- Carronite baths have a 30 year guarantee

- Whirl Pool 
- Shower 
- Grips 
- Head Rest 



Head-rests available for all baths





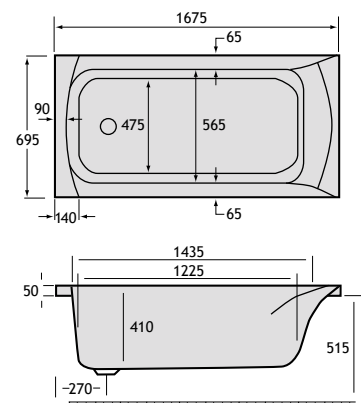

Description	Code	£ Ex VAT	£ Inc VAT
Universal foam headrest	84.0001	28.00	33.60
Universal PU Gel Headrest	84.0000	55.00	66.00



5'6"

IMPERIAL 5'6"



- Shower 
- Whirl Pool 
- Grips 
- Head Rest 

At long last, a genuine 5'6" bath. A very practical option when replacing old imperial baths. Features a full length textured base.

1675 x 700 x 400mm **180 Litres**

Description	Code	£ Ex VAT	£ Inc VAT
5'6" TG 5mm	23.0181	222.00	266.40
5'6" TG Carronite	23.2181	413.00	495.60
Headrest HR800	23.312	106.00	127.20

PANELS

L shaped C/nite 1700x700x515	23.3571*	273.00	327.60
Quantum front panel 1675x515	23.1030	96.00	115.20
Carronite front panel 1675x515	23.1036	138.00	165.60
Universal end panel 700x515	23.1611	76.00	91.20
Carronite end panel 700x515	23.1421	100.00	120.00

*This panel needs to be cut down.

The Imperial range includes:
1400 x 700 (P47), 1500 x 700 (P49),
1600 x 700 (P53), 1700 x 700 (P63),
1800 x 750 (P86)

FEATURES

- Chrome twin grips
- Bespoke whirlpool available
- Suitable for showering
- No tap holes or waste fittings
- Carronite baths have a 30 year guarantee
- Full length textured base

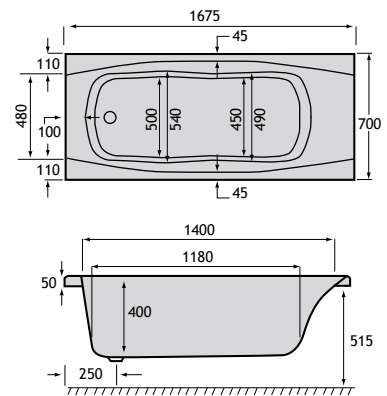

ALBANY 1700

A compact yet spacious double-ended, centre waste bath, one of the first of its type at a genuine 700mm wide.

1700 x 700 x 410mm **160 Litres**

Description	Code	£ Ex VAT	£ Inc VAT
1700 x 700 5mm	23.0021	306.00	367.20
1700 x 700 Carronite	23.2021	490.00	588.00
Albany 1700 x 700 Double Ended 5mm	23.312	106.00	127.20

PANELS

L shaped C/nite 1700x700x515	23.3571	273.00	327.60
Quantum front panel 1700x515	23.3251	96.00	115.20
Quantum C/nite 1700x515	23.3301	138.00	165.60
Universal end panel 700x515	23.1611	76.00	91.20
Carronite end panel 700x515	23.1421	100.00	120.00

Also available in the Albany/Alpha range:
1700 x 750 (P74), 1800 x 800 (P89)

FEATURES

- Optional headrest available
- Stocked Carronite 6 jet c lenda whirlpool available, page 160
- Bespoke whirlpool available
- No tap holes or waste fittings

Whirl Pool 

Head Rest 

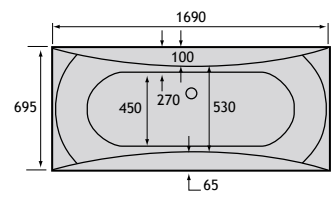

Head-rests available for all baths



Description	Code	£ Ex VAT	£ Inc VAT
Universal foam headrest	84.0001	28.00	33.60
Universal PU Gel Headrest	84.0000	55.00	66.00

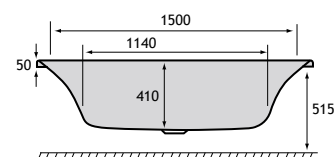

ARC SINGLE ENDED

A new design, single ended bath that has a wide curved end for comfort and luxury in bathing with plenty of space for showering.

1700 x 700 x 400mm **172 litres**

Description	Code	£ Ex VAT	£ Inc VAT
1700 x 700 5mm	23.4601	213.00	255.60
1700 x 700 Carronite	23.5601	408.00	489.60

PANELS

L shaped C/nite 1700x700x515	23.3571	273.00	327.60
Quantum front panel 1700x515	23.3251	96.00	115.20
Quantum C/nite 1700x515	23.3301	138.00	165.60
Universal end panel 700x515	23.1611	76.00	91.20
Carronite end panel 700x515	23.1421	100.00	120.00

Also available in the Arc single-ended range:
1500 (P48), 1700 x 750 (P75)

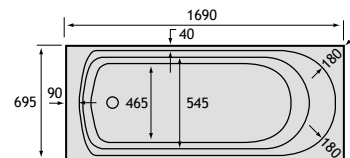
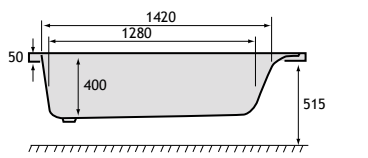

FEATURES

- Bespoke whirlpool available
- Suitable for showering

- No tap holes or waste fittings
- Carronite baths have a 30 year guarantee

AXIS 1700

This low-level easy access bath is based on the design of the Classic shower bath. Due to its low-level it makes an excellent bath and shower bath for the less mobile.

1700 x 700 x 345mm **145 Litres**

Description	Code	£ Ex VAT	£ Inc VAT
Straight Bath 5mm	23.4351	227.00	272.40
Straight TG 5mm	23.4421	257.00	308.40
Straight bath Carronite	23.5351	426.00	511.20
Straight TG Carronite	23.5421	456.00	547.20
Headrest HR800	23.312	106.00	127.20

PANELS

L shaped C/nite 1700x700x430	23.1018	273.00	327.60
Quantum panel 1700x430	23.1042	96.00	115.20
Quantum C/nite panel 1700x430	23.1044	138.00	165.60
Universal end panel 700x430	23.1771	76.00	91.20
Carronite end panel 700x430	23.1811	100.00	120.00

Also available in the Axis range:
1500 (P78), 1600 (P52)

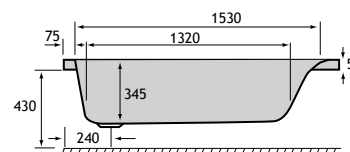
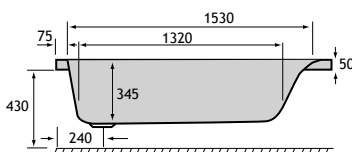

FEATURES

- Available with chrome twin grips
- Low level - easy access
- Suitable for showering

- No tap holes or waste fittings
- Carronite baths have a 30 year guarantee

CAMDEN 1700

This newly designed single ended bath with straight sides and minimalist lines maximising both bathing and showering space.

1700 x 700 x 515mm **209 Litres**

Description	Code	£ Ex VAT	£ Inc VAT
1700 x 700 5mm	23.6024	261.00	313.20
1700 x 700 Carronite	23.6025	484.00	580.80

PANELS

L shaped C/nite 1700x700x515	23.3571	273.00	327.60
Quantum front panel 1700x515	23.3251	96.00	115.20
Quantum C/nite 1700x515	23.3301	138.00	165.60
Universal end panel 700x515	23.1611	76.00	91.20
Carronite end panel 700x515	23.1421	100.00	120.00

Also available in the Camden range:
1600 x 700 (P56), 1650 x 700 (P58)

FEATURES

- No tap holes or waste fittings
- Suitable for showering
- Carronite baths have a 30 year guarantee
- Optional headrest available

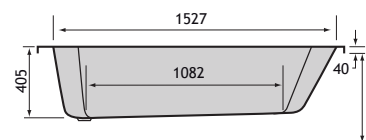
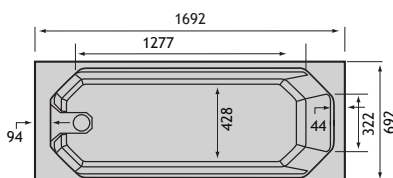

1700

DELTA 1700

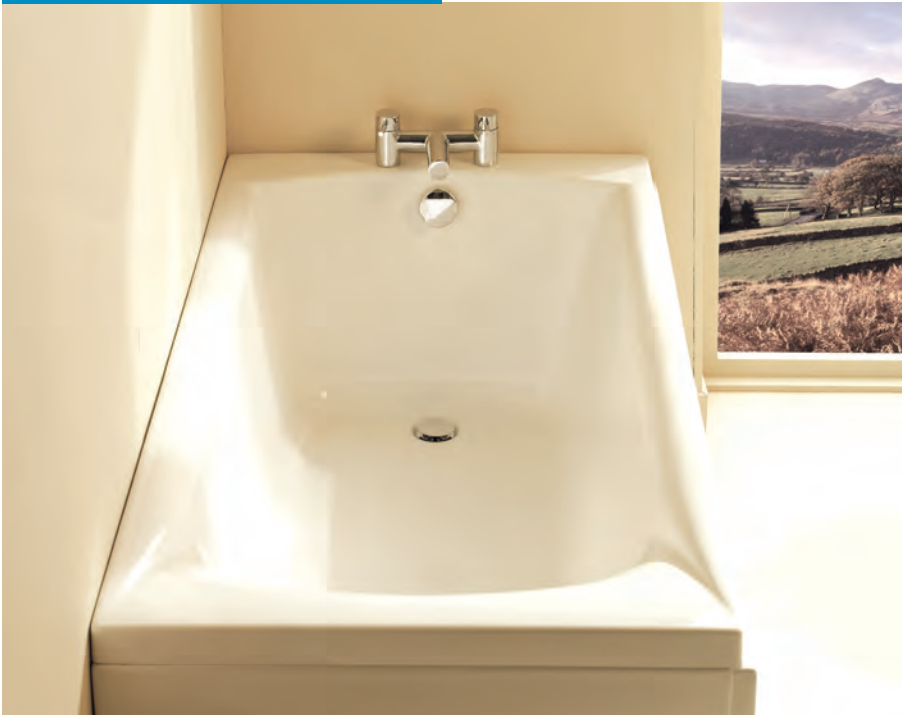

The up-to-the-minute simplicity of line and form lend timeless appeal to Carron's latest designer range. Comfortably proportioned, the Delta offers width and depth that invite you to indulge in a long, de-stressing soak.

1700 x 700 x 410mm		172 Litres	
Description	Code	£ Ex VAT	£ Inc VAT
1700 x 700 5mm	23.0731	291.00	349.20
1700 x 700 Carronite	23.2731	528.00	633.60
1700 x 700 TG 5mm	23.4241	332.00	398.40
1700 x 700 TG Carronite	23.5241	569.00	682.80
Headrest HR800	23.312	106.00	127.20

PANELS

L shaped C/nite 1700x700x515	23.3571	273.00	327.60
Quantum front panel 1700x515	23.3251	96.00	115.20
Quantum C/nite 1700x515	23.3301	138.00	165.60
Universal end panel 700x515	23.1611	76.00	91.20
Carronite end panel 700x515	23.1421	100.00	120.00

Also available in the Delta range: 1400 (P46), 1500 (P48), 1600 (P53), 1650 (P58), 5'6" (P59)

FEATURES

- Available with chrome twin grips
- Stocked Carronite 6 jet c lenda whirlpool available, page 156
- Optional headrest available
- Bespoke whirlpool available
- No tap holes or waste fittings

Head-rests available for all baths



Description	Code	£ Ex VAT	£ Inc VAT
Universal foam headrest	84.0001	28.00	33.60
Universal PU Gel Headrest	84.0000	55.00	66.00

- Shower
- Whirl Pool
- Grips
- Head Rest

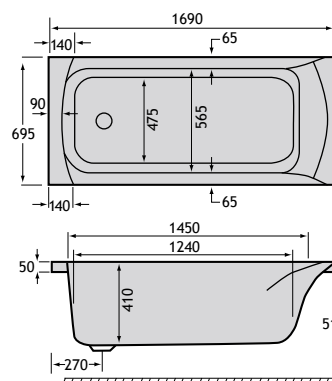

BRITANNIA VICTORIA 1700

- Shower
- Head Rest



A highly practical, tasteful bath with a nostalgic Victorian feel.

1700 x 700 x 360mm		155 Litres	
Description	Code	£ Ex VAT	£ Inc VAT
1700 x 700 5mm	23.0131	249.00	298.80
1700 x 700 Super 8mm	23.8002	312.00	374.40
1700 x 700 Carronite	23.2131	436.00	523.20

PANELS

L shaped C/nite 1700x700x515	23.3571	273.00	327.60
Quantum front panel 1700x515	23.3251	96.00	115.20
Quantum C/nite 1700x515	23.3301	138.00	165.60
Universal end panel 700x515	23.1611	76.00	91.20
Carronite end panel 700x515	23.1421	100.00	120.00

Also available in the Quantum Integra Eco range: 1600 (P55), 1700 (P67)

FEATURES

- Suitable for showering
- No tap holes or waste fittings
- Carronite baths have a 30 year guarantee

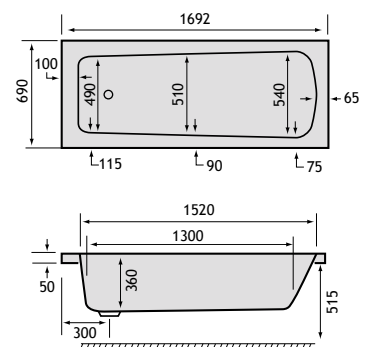

IBIS 1700

- Grips 
- Head Rest 



The Ibis is a classic bath at an affordable price. This is one of the widest baths in this length at the sitting end. Includes an integral soap dish. Features half length textured base.

1700 x 700 x 360mm		155 Litres	
Description	Code	£ Ex VAT	£ Inc VAT
1700 x 700 TG 5mm	23.0121	252.00	302.40
1700 x 700 TG Carronite	23.2121	445.00	534.00

PANELS

L shaped C/nite 1700x700x515	23.3571	273.00	327.60
Quantum panel 1700x515	23.3251	96.00	115.20
Quantum C/nite 1700x515	23.3301	138.00	165.60
Universal end panel 700x515	23.1611	76.00	91.20
Carronite end panel 700x515	23.1421	100.00	120.00

FEATURES

- Available with chrome twin grips
- Integral soap dish
- Half length textured base
- No tap holes or waste fittings
- Carronite baths have a 30 year guarantee

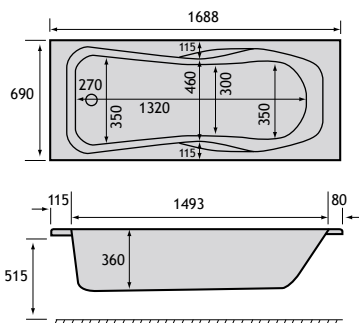

IMPERIAL 1700

This best-selling bath with traditional finish and grips is now available in standard length. Features full length textured base.

1700 x 700 x 400mm		180 Litres	
Description	Code	£ Ex VAT	£ Inc VAT
1700 x 700 TG 5mm	23.4191	222.00	266.40
1700 x 700 TG Carronite	23.5191	413.00	495.60
Headrest HR800	23.312	106.00	127.20

PANELS





L shaped C/nite 1700x700x515	23.3571	273.00	327.60
Quantum front panel 1700x515	23.3251	96.00	115.20
Quantum C/nite 1700x515	23.3301	138.00	165.60
Universal end panel 700x515	23.1611	76.00	91.20
Carronite end panel 700x515	23.1421	100.00	120.00

The Imperial range includes:
 1400 x 700 (P47), 1500 x 700 (P49),
 5'6" (P60), 1600 x 700 (P53),
 1700 x 700 (P63), 1800 x 750 (P86)

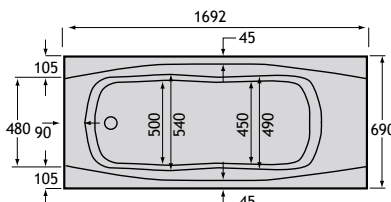
FEATURES

- Available with chrome twin grips
- Stocked Carronite 6 jet c lenda whirlpool available, page 168
- Optional headrest available
- Bespoke whirlpool available
- Suitable for showering
- No tap holes or waste fittings
- Carronite baths have a 30 year guarantee
- Full length textured base



- Shower 
- Whirl Pool 
- Grips 
- Head Rest 

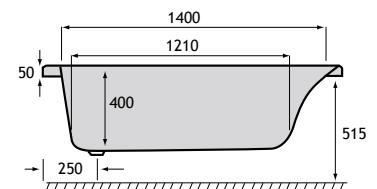

1700

MATRIX 1700



The Matrix is identical to the Axis but is supplied with a standard leg pack. It is the ideal bath for showering with the addition of shower screen.

1700 x 700 x 345mm		145 Litres	
Description	Code	£ Ex VAT	£ Inc VAT
1700 x 700 5mm	23.4361	227.00	272.40
1700 x 700 Carronite	23.4431	257.00	308.40
1700 x 700 TG 5mm	23.5361	426.00	511.20
1700 x 700 TG Carronite	23.5431	456.00	547.20
Matrix 1700 straight 5mm	23.312	106.00	127.20

PANELS

L shaped C/nite 1700x700x515	23.3571	273.00	327.60
Quantum front panel 1700x515	23.3251	96.00	115.20
Quantum C/nite 1700x515	23.3301	138.00	165.60
Universal end panel 700x515	23.1611	76.00	91.20
Carronite end panel 700x515	23.1421	100.00	120.00

Also available in the Matrix range:
1500 (P49), 1600 (P54)

FEATURES

- Available with chrome twin grips
- Optional headrest available
- Suitable for showering
- No tap holes or waste fittings
- Carronite baths have a 30 year guarantee

Head-rests available for all baths



Description	Code	£ Ex VAT	£ Inc VAT
Universal foam headrest	84.0001	28.00	33.60
Universal PU Gel Headrest	84.0000	55.00	66.00

- Shower
- Grips
- Head Rest



NEO-CLASSICAL 1700

Head Rest



The straight, simplistic lines of the Neo suit any surrounding. The bath transforms a classic form into a modern or art-deco design.

1700 x 700 x 400mm		180 Litres	
Description	Code	£ Ex VAT	£ Inc VAT
1700 x 700 5mm	23.0601	261.00	313.20
1700 x 700 Carronite	23.2601	436.00	523.20

PANELS

L shaped C/nite 1700x700x515	23.3571	273.00	327.60
Quantum front panel 1700x515	23.3251	96.00	115.20
Quantum C/nite 1700x515	23.3301	138.00	165.60
Universal end panel 700x515	23.1611	76.00	91.20
Carronite end panel 700x515	23.1421	100.00	120.00

FEATURES

- No tap holes or waste fittings
- Carronite baths have a 30 year guarantee

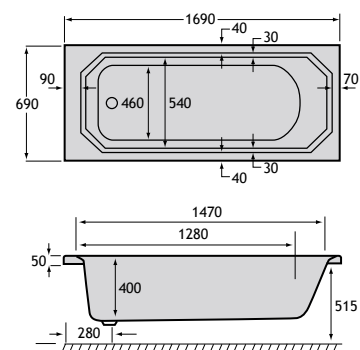
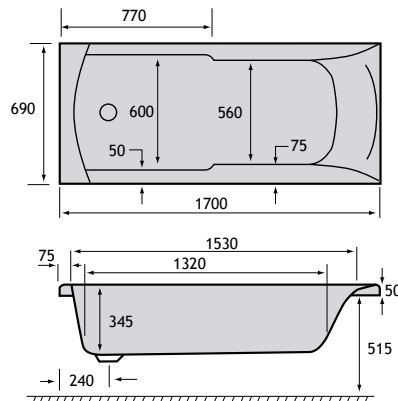

PROFILE 1700



A modern bath with a 33mm ledge on three sides for a sleek minimalist look and optimum bathing space.

1700 x 700 x 400mm		218 Litres	
Description	Code	£ Ex VAT	£ Inc VAT
Profile 1700x700 5mm	23.0047	261.00	313.20
Profile 1700x700 5mm	23.2047	484.00	580.80

PANELS

L shaped C/nite 1700x700x515	23.3571	273.00	327.60
Quantum panel 1700x515	23.3251	96.00	115.20
Quantum C/nite 1700x515	23.3301	138.00	165.60
Universal end panel 700x515	23.1611	76.00	91.20
Carronite end panel 700x515	23.1421	100.00	120.00

BATH SCREENS

Corniche 8mm 800x1400	69.0142	212.00	254.40
Volente 6mm 850x1500	58.702	158.00	189.60
Volente 8mm 850x1500	58.703	163.00	195.60

Also available in the Profile range:
1500 (P50), 1600 (P54), 1700 x 750 (P65)

FEATURES

- No tap holes or waste fittings
- Carronite baths have a 30 year guarantee
- Optional headrest available



- Shower 
- Head Rest 

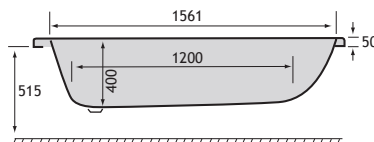
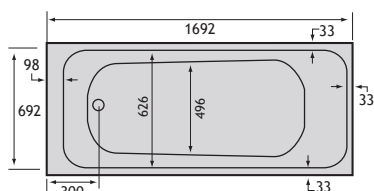

1700

PROFILE DUO 1700



Head Rest

Taking the popular Profile range to a new level of luxury with a double ended option. Also available in 1600 and 1700 x 750.

1700 x 700 x 410mm		205Litres	
Description	Code	£ Ex VAT	£ Inc VAT
Profile 1700x700 Duo 5mm	23.0056	261.00	313.20
Profile 1700x700 Duo C/nite	23.2056	484.00	580.80

PANELS

L shaped C/nite 1700x700x515*	23.3571	273.00	327.60
Quantum panel 1700x515	23.3251	96.00	115.20
Quantum C/nite 1700x515	23.3301	138.00	165.60
Universal end panel 700x515	23.1611	76.00	91.20
Carronite end panel 700x515	23.1421	100.00	120.00

Also available in the Profile range:
1600 x 700 (P54), 1650 x 700 (P58), 1700 x 750 (P77)

FEATURES

- No tap holes or waste fittings
- Carronite baths have a 30 year guarantee
- Optional headrest available

QUANTUM SE 1700 X 700



Shower

Whirl Pool

Head Rest

A new design single ended bath with straight sides and minimalist lines maximising both bath and showering space. See page 55 for gripped version.

1700 x 700 x 410mm		228 Litres	
Description	Code	£ Ex VAT	£ Inc VAT
1700 x 700 5mm	23.4661	227.00	272.40
1700 x 700 Carronite	23.5661	428.00	513.60
HR900 Headrest	23.309	106.00	127.20

PANELS

L shaped C/nite 1700x700x515*	23.3571	273.00	327.60
Quantum panel 1700x515	23.3251	96.00	115.20
Quantum C/nite 1700x515	23.3301	138.00	165.60
Universal end panel 700x515	23.1611	76.00	91.20
Carronite end panel 700x515	23.1421	100.00	120.00

Also available in the Quantum range:
1500 x 700 (P51), 1600 x 700/800 (P55/57),
1700 x 750/800/900 (P78/82/84),
1800 x 725 (P86), 1800 x 800 (P92)

FEATURES

- Optional headrest available
- Bespoke whirlpool available
- Suitable for showering
- No tap holes or waste fittings
- Carronite baths have a 30 year guarantee

QUANTUM DUO 1700 X 700

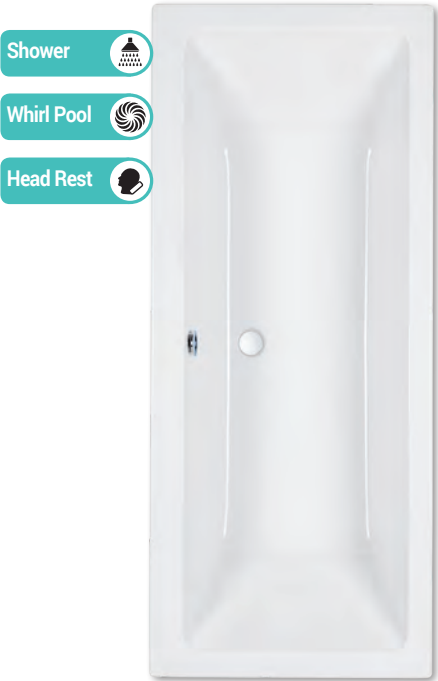

Shower

Whirl Pool

Head Rest

A modern and minimalist version of a double ended bath. The straight sides and sloping backs give a spacious bathing area. It has a central waste and overflow below the tap ledge and is suitable for a bath screen.

1700 x 700 x 410mm		165 Litres	
Description	Code	£ Ex VAT	£ Inc VAT
1700 x 700 5mm	23.4501	227.00	272.40
1700 x 700 Carronite	23.5501	428.00	513.60
HR900 Headrest	23.309	106.00	127.20

PANELS

L shaped C/nite 1700x700x515	23.3571	273.00	327.60
Quantum Duo 1700 x 700 plain 5mm	23.3251	96.00	115.20
Quantum Carronite 1700x515	23.3301	138.00	165.60
Universal end panel 700x515	23.1611	76.00	91.20
Carronite end panel 700x515	23.1421	100.00	120.00

Also available in the Quantum Duo range:
1700 x 750/800 (P78/82), 1800 x 800 (P92),
1900 x 900 (P95)

FEATURES

- Optional headrest available
- Bespoke whirlpool available
- Suitable for showering
- No tap holes or waste fittings
- Carronite baths have a 30 year guarantee

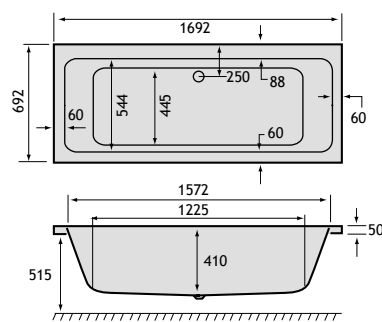
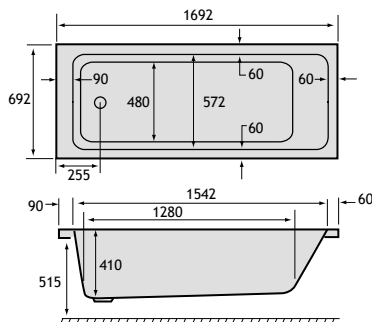
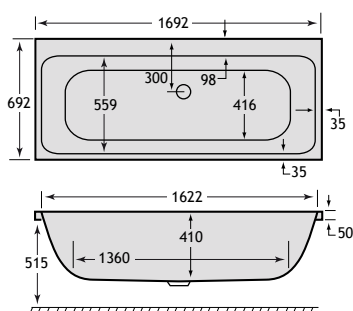

QUANTUM INTEGRA ECO STANDARD HEIGHT



Taking the popular Quantum range to a new level with sleek integrated grips for added security.

1700 x 700 x 345mm	174 Litres		
Description	Code	£ Ex VAT	£ Inc VAT
Quantum Integra 1700 x 700 Eco TG 5mm	23.6038	263.00	315.60
Quantum Integra 1700 x 700 Eco TG Carronite	23.6041	458.00	549.60
HR900 Headrest	23.309	106.00	127.20

PANELS

L shaped C/nite 1700x700x515	23.3571	273.00	327.60
Quantum Front Panel 1700x515	23.3251	96.00	115.20
Quantum Carronite 1700x515	23.3301	138.00	165.60
Universal end panel 700x515	23.1611	76.00	91.20
Carronite end panel 700x515	23.1421	100.00	120.00

BATH SCREENS

Corniche 8mm 800x1400	69.0142	212.00	254.40
Volente 6mm 850x1500	58.702	158.00	189.60
Volente 8mm 850x1500	58.703	163.00	195.60

Also available in the Quantum Integra Eco Standard range: 1500 (P50), 1600 (P55)

FEATURES

- Chrome twin grips
- Optional headrest available
- No tap holes or waste fittings
- Carronite baths have a 30 year guarantee

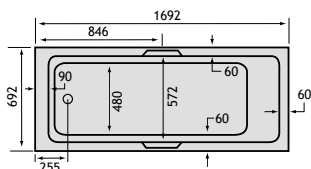

Head-rests available for all baths



Description	Code	£ Ex VAT	£ Inc VAT
Universal foam headrest	84.0001	28.00	33.60
Universal PU Gel Headrest	84.0000	55.00	66.00

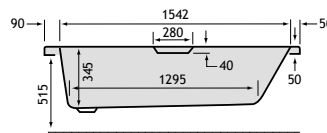

QUANTUM INTEGRA ECO LOW LEVEL



Taking the popular Quantum range to a new level with sleek integrated grips for added security and low-level for easy access.

1700 x 700 x 345mm	174 Litres		
Description	Code	£ Ex VAT	£ Inc VAT
Quantum Integra Low Level 1700 x 700 Eco TG 5mm	23.0034	263.00	315.60
Quantum Integra Low Level 1700 x 700 Eco TG Carronite	23.2034	458.00	549.60
HR900 Headrest	23.309	106.00	127.20

PANELS

1700 L shaped panel Carronite	23.1018	273.00	327.60
Quantum panel 1700 x 430	23.1042	96.00	115.20
Quantum C/nite panel 1700x430	23.1044	138.00	165.60
End panel	23.1771	76.00	91.20
End panel Carronite	23.1811	100.00	120.00

BATH SCREENS

Corniche 8mm 800x1400	69.0142	212.00	254.40
Volente 6mm 850x1500	58.702	158.00	189.60
Volente 8mm 850x1500	58.703	163.00	195.60

Also available in the Quantum Integra Eco Low Level range: 1500 (P50), 1600 (P55)

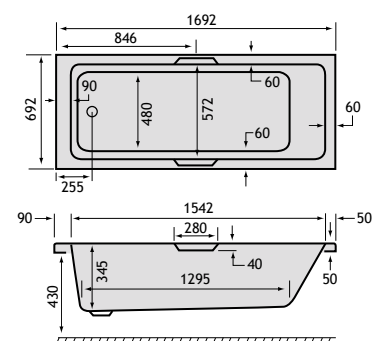

1700

QUANTUM SINGLE ENDED INTEGRA



Combining the added safety and security that comes with a gripped bath, with the sleek, modern lines of the existing Quantums. The Integra features an integrated grip that has been designed to complement the original Quantum design.

1700 x 700 x 410mm		228 Litres	
Description	Code	£ Ex VAT	£ Inc VAT
1700 x 700 TG 5mm	23.4951	263.00	315.60
1700 x 700 TG Carronite	23.5951	458.00	549.60
HR900 Black headrest	23.309	106.00	127.20

PANELS

L shaped C/nite 1700x700x515*	23.3571	273.00	327.60
Quantum front panel 1700x515	23.3251	96.00	115.20
Quantum C/nite 1700x515	23.3301	138.00	165.60
Universal end panel 700x515	23.1611	76.00	91.20
Carronite end panel 700x515	23.1421	100.00	120.00

BATH SCREENS

Corniche 8mm 800x1400	69.0142	212.00	254.40
Volente 6mm 850x1500	58.702	158.00	189.60
Volente 8mm 850x1500	58.703	163.00	195.60

Also available in the Quantum Integra range: 1500 (P51), 1600 (P56), 1650 x 700 (P59), 1700 x 750/800 (P79/81), 1800 x 800 (P92)

FEATURES

- Available with chrome twin grips
- Bespoke whirlpool available
- Suitable for showering
- No tap holes or waste fittings
- Carronite baths have a 30 year guarantee



Shower 

Whirl Pool 

Grips 

Head Rest 

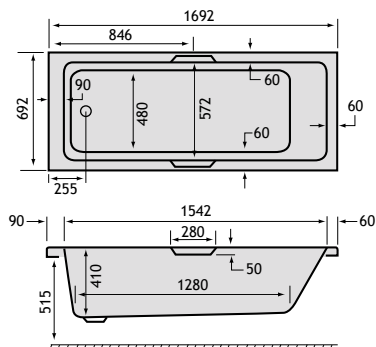

SWALLOW 1700

Grips 

Head Rest 



A comfortable bath with a proven pedigree, the Swallow can be found in five star hotels worldwide. Includes an integral soap dish and features a half length textured base.

1700 x 700 x 365mm		155 Litres	
Description	Code	£ Ex VAT	£ Inc VAT
1700 x 700 Plain 2TH 5mm	23.4000	204.00	244.80
1700 x 700 TG 2TH 5mm	23.4001	204.00	244.80
1700 x 700 Super 8 Plain 8mm	23.8000	279.00	334.80
1700 x 700 Super 8 TG 8mm	23.8001	279.00	334.80
1700 x 700 TG Carronite	23.2461	435.00	522.00

PANELS

L shaped C/nite 1700x700x515	23.3571	273.00	327.60
Quantum front panel 1700x515	23.3251	96.00	115.20
Quantum C/nite 1700x515	23.3301	138.00	165.60
Universal end panel 700x515	23.1611	76.00	91.20
Carronite end panel 700x515	23.1421	100.00	120.00

*Note: The 1700 5mm model is supplied with tap holes.

Also available in the Swallow range: 1800 (P85)

FEATURES

- Available with chrome twin grips
- No tap holes or waste fittings
- Carronite baths have a 30 year guarantee
- Half length textured base
- Integral soap dish

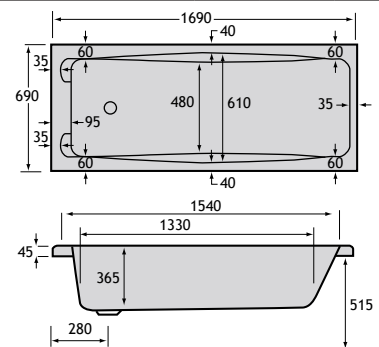

STATUS 1700

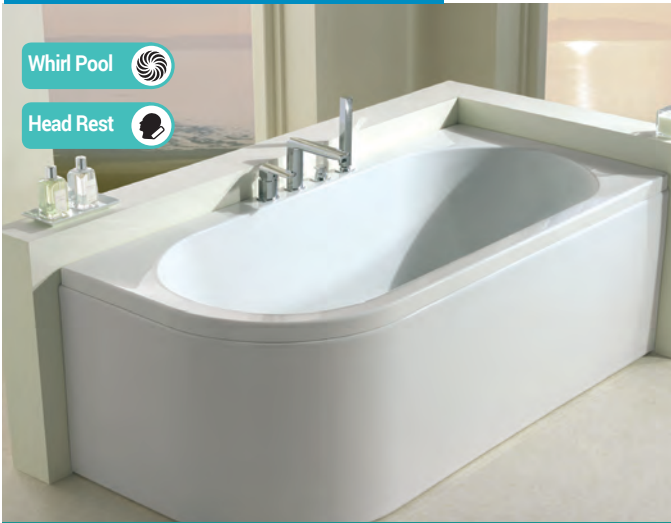

Whirl Pool 

Head Rest 

Taps for illustration purposes only. This bath has a suspended panel. Left hand shown, bath to be fitted in a corner situation only.



Bringing a unique perspective to bathroom design the Status adds a touch of luxury with its soft curves and ideal proportions.

1700 x 725 x 425mm		205 Litres	
Description	Code	£ Ex VAT	£ Inc VAT
1700 x 725 RH 5mm	23.4491R	416.00	499.20
1700 x 725 LH 5mm	23.4491L	416.00	499.20
1700 x 725 RH Carronite	23.5491R	705.00	846.00
1700 x 725 LH Carronite	23.5491L	705.00	846.00

PANELS

1700 x 725 x 540 panel	23.3151	201.00	241.20
1700 x 725 x 540 Carronite panel	23.1961	285.00	342.00

*No shower screen available.

Also available in the Status range:
1600 x 725 (P57), 1700 x 725 (P69), 1700 x 800 (P83),
Status showerbath 1550 x 850 (P101)

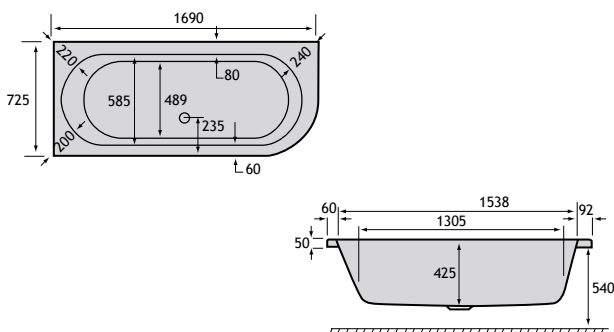

URBAN

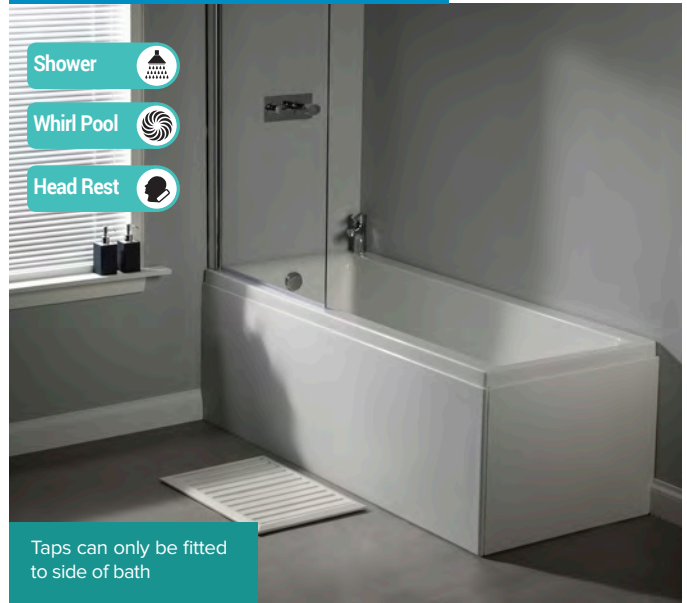

Shower 

Whirl Pool 

Head Rest 

Taps can only be fitted to side of bath

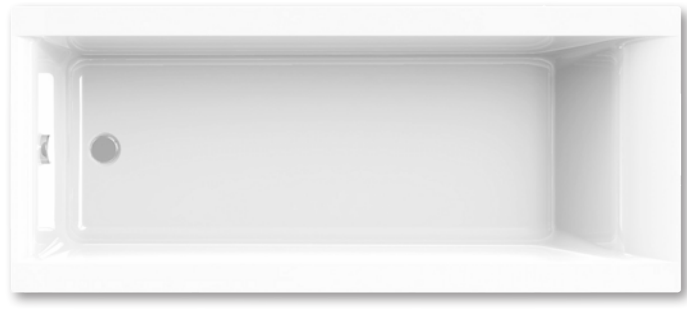

A modern angular bath, also available in 1500 and 1700 showerbath (see page 110 for Urban showerbath), and Urban Sitbath (P46).

1700 x 725 x 410mm		224 Litres	
Description	Code	£ Ex VAT	£ Inc VAT
1700 x 725 5mm	23.0017	290.00	348.00
1700 x 725mm Carronite	23.2017	459.00	550.80

PANELS

L shaped C/nite 1700x750x540*	57.1061	276.00	331.20
Quantum panel 1700x540	23.3261	107.00	128.40
Concord panel 1700 x 540	23.1571	108.00	129.60
Quantum C/nite 1700x540	23.3311	138.00	165.60
Carronite panel 1700 x 540	23.1381	146.00	175.20
Carronite end panel 750x540*	23.3431	100.00	120.00
End panel 5mm 725 x 540	23.3421	76.00	91.20

*This panel needs to be cut down.

FEATURES

- Bespoke whirlpool available
- No tap holes or waste fittings
- Carronite baths have a 30 year guarantee
- Optional headrest available

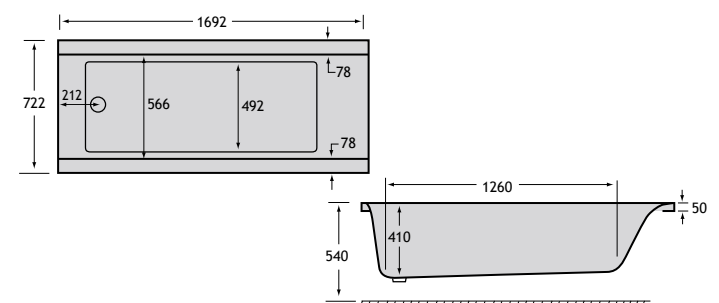

1700

EQUATION 1700



A spacious double ended bath with a large central tap ledge to allow for all modern combinations of taps.

1700 x 740 x 420mm		205 Litres	
Description	Code	£ Ex VAT	£ Inc VAT
1700 x 750 5mm	23.4811	365.00	438.00
1700 x 750 Carronite	23.5811	562.00	674.40

PANELS

Description	Code	£ Ex VAT	£ Inc VAT
L shaped C/nite 1700x750x540*	57.1061	276.00	331.20
Quantum panel 1700x540	23.3261	107.00	128.40
Concord panel 1700 x 540	23.1571	108.00	129.60
Quantum C/nite 1700x540	23.3311	138.00	165.60
Carronite panel 1700 x 540	23.1381	146.00	175.20
Universal end panel 750x540	23.1631	76.00	91.20
Carronite end panel 750x540	23.1441	100.00	120.00

*These panels need to be cut down.

Also available in the Equation range:
1800 x 792 (P86)

FEATURES

- Bespoke whirlpool available
- Stocked Carronite 6 jet c lenda whirlpool available, page 154
- No tap holes or waste fittings
- Carronite baths have a 30 year guarantee

Head-rests available for all baths



Description	Code	£ Ex VAT	£ Inc VAT
Universal foam headrest	84.0001	28.00	33.60
Universal PU Gel Headrest	84.0000	55.00	66.00

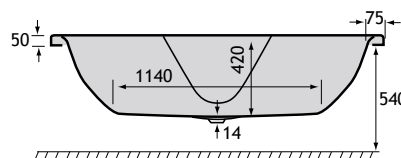
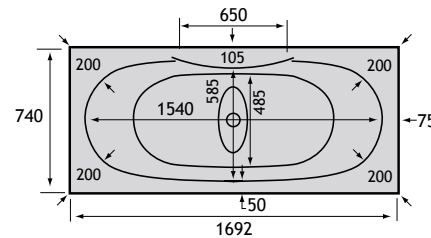

Whirl Pool

Head Rest



QUANTUM SPACE SAVER



Shower 

Whirl Pool 

Head Rest 

Left hand Shown

The Quantum Space Saver is the ideal bath for small, tight spaces. Featuring a wider end that is suitable for showering, the bath then narrows to ensure it will fit in even the tightest spaces.

1700 x 742 x 420mm		211 Litres	
Description	Code	£ Ex VAT	£ Inc VAT
Quantum Spacesaver 5mm LH	23.4941L	327.00	392.40
Quantum Spacesaver 5mm RH	23.4941R	327.00	392.40
Quantum Spacesaver Carronite LH	23.5941L	523.00	627.60
Quantum Spacesaver Carronite RH	23.5941R	523.00	627.60
Quantum Spacesaver End Panel Carronite	23.3681	95.00	114.00
Quantum screen 1400mm with towel rail*	69.0141	331.00	397.20
Quantum screen	58.4000	245.00	294.00
HR900 Headrest	23.309	106.00	127.20

PANELS

Quantum Spacesaver Front Panel	23.3581	149.00	178.80
Quantum Spacesaver Front Panel Carronite	23.3591	285.00	342.00
Quantum Spacesaver End Panel	23.3671	68.00	81.60
Quantum Spacesaver End Panel Carronite	23.3681	95.00	114.00

* Installation tolerance allows for wall covering up to 12mm. This bath has a suspended panel.

FEATURES

- Bespoke whirlpool available
- Suitable for showering
- No tap holes or waste fittings
- Carronite baths have a 30 year guarantee
- Optional headrest available

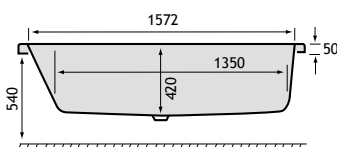

RIGHT HAND SHOWN

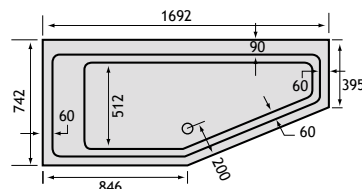

1700

HIGHGATE 1700



An art deco inspired bath that combines style with functionality.

1700 x 750 x 540mm		216 Litres	
Description	Code	£ Ex VAT	£ Inc VAT
1700 x 750 Carronite SE TG	23.6001	828.00	993.60
1700 x 750 Carronite SE Plain*	23.6002	745.00	894.00

PANELS

1700 x 540 C/nite panel	23.6013	166.00	199.20
1700 x 750 x 540 C/nite L panel	23.6015	281.00	337.20

SCREENS

Highgate Screen LH - Etched*	23.6017	216.00	259.20
Highgate Screen RH - Etched*	23.6018	216.00	259.20

*See page 88 for image. *While stocks last

Also available in the Highgate range:
1800 (P88), Highgate Showerbath (P109)

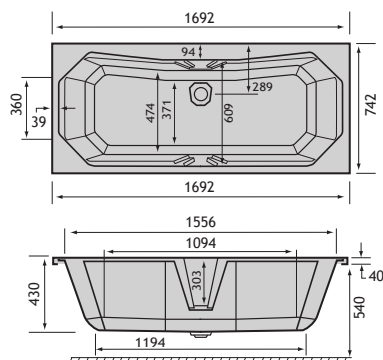

HIGHGATE DUO 1700



A double-ended version of the art deco inspired bath that combines style with functionality.

1700 x 750 x 540mm		210 Litres	
Description	Code	£ Ex VAT	£ Inc VAT
1700 x 750 Carronite DE Single Grip	23.6005	870.00	1044.00
1700 x 750 Carronite DE Plain	23.6006	828.00	993.60

PANELS

1700 x 540 C/nite panel	23.6013	166.00	199.20
1700 x 750 x 540 C/nite L panel	23.6015	281.00	337.20

SCREENS

Highgate Screen LH - Etched*	23.6017	216.00	259.20
Highgate Screen RH - Etched*	23.6018	216.00	259.20

*See page 88 for image.

Also available in the Highgate range:
1800 (P88), Highgate Showerbath (P109)

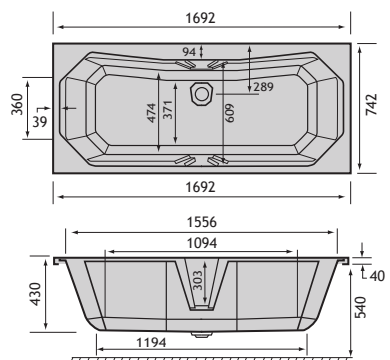

Luxury chrome combined integral waterfall filler, (WRAS certified) overflow and flush fitting pop-up waste is included in the price of the bath.

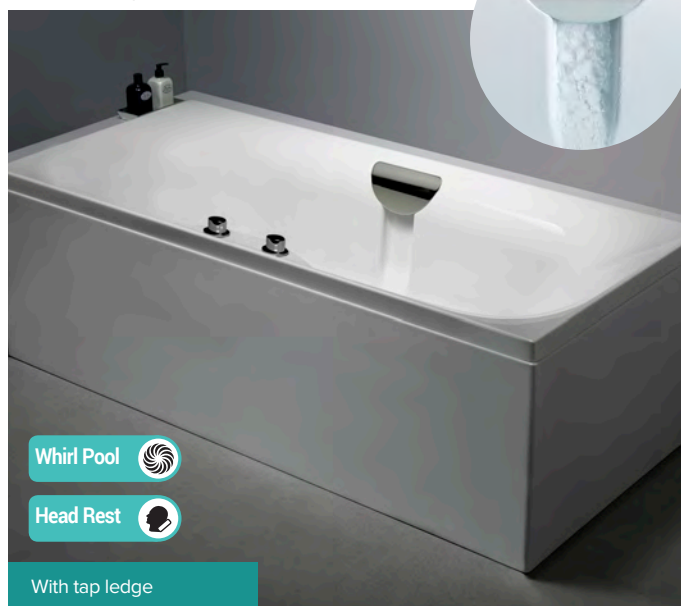

Whirl Pool

Head Rest

With tap ledge

ECHELON 1700



Whirl Pool

Head Rest

Without tap ledge



A spacious double ended bath available with our unique filler, in both 1700 and 1800 sizes. Baths come with filler, waste and overflow. Separate control valves are required to use the filler. Also available with a tap ledge.

Also available in the Echelon range with or without tap ledge: 1800 x 800 (P90)

1700 x 750 x 420mm		209 Litres	
Description	Code	£ Ex VAT	£ Inc VAT
1700 x 750 5mm	23.4831	668.00	801.60
1700 x 750 Carronite	23.5831	931.00	1117.20
TAP LEDGE			
1700 x 750 C/nite with tap ledge	23.5871	931.00	1117.20
PANELS			
L shaped C/nite 1700x750x540	57.1061	276.00	331.20
Quantum front panel 1700x540	23.3261	107.00	128.40
Concord panel 1700 x 540	23.1571	108.00	129.60
Quantum Carronite 1700x540	23.3311	138.00	165.60
Carronite panel 1700 x 540	23.1381	146.00	175.20
Universal end panel 750x540	23.1631	76.00	91.20
Carronite end panel 750x540	23.1441	100.00	120.00

*No shower screen available.

FEATURES

- Available with or without tap ledge
- Optional headrest available
- Comes with filler and overflow
- Complete with push button waste
- No tap holes
- WRAS certified filler
- Carronite baths have a 30 year guarantee

Head-rests available for all baths



Description	Code	£ Ex VAT	£ Inc VAT
Universal foam headrest	84.0001	28.00	33.60
Universal PU Gel Headrest	84.0000	55.00	66.00

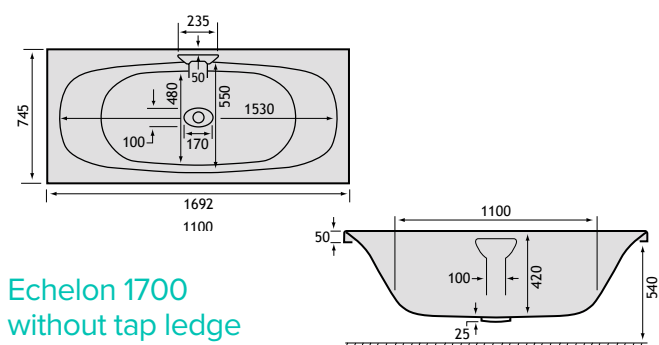

Echelon 1700 without tap ledge

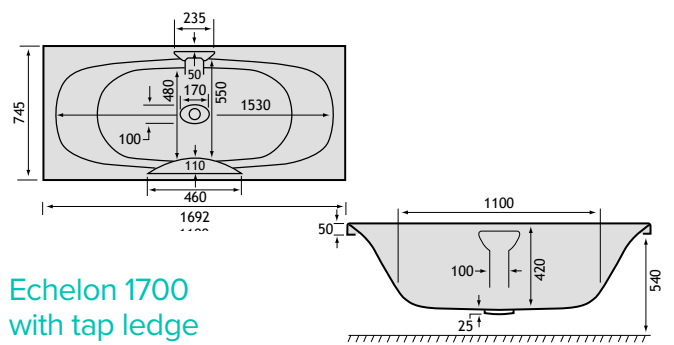

Echelon 1700 with tap ledge

1700

ALPHA 1700

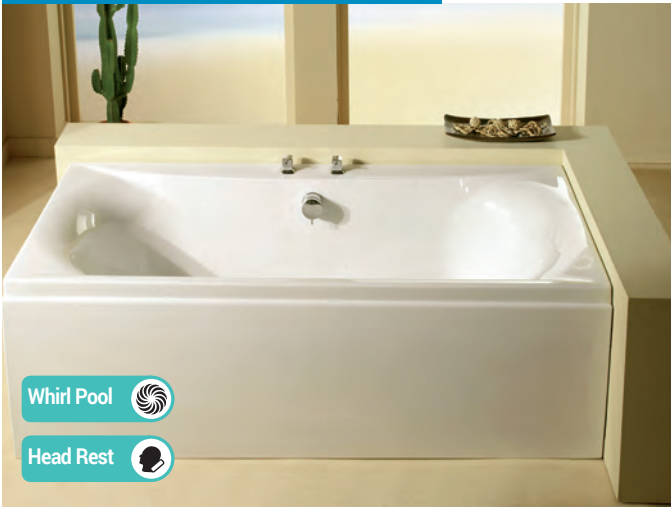

- Whirl Pool 
- Head Rest 



With its stylish centre-tap placement, the Alpha is the latest in bath design for comfort as well as looks. Deep and welcoming, its minimalist styling lends itself superbly to contemporary design schemes. An inspiring and invigorating centrepiece for any bathroom.

1700 x 750 x 420mm		175 Litres	
Description	Code	£ Ex VAT	£ Inc VAT
1700 x 750 5mm	23.4101	368.00	441.60
1700 x 750 Carronite	23.5101	572.00	686.40
Headrest HR800	23.312	106.00	127.20

PANELS

L shaped C/nite 1700x750x540	57.1061	276.00	331.20
Quantum panel 1700x540	23.3261	107.00	128.40
Concord panel 1700 x 540	23.1571	108.00	129.60
Quantum C/nite 1700x540	23.3311	138.00	165.60
Carronite panel 1700 x 540	23.1381	146.00	175.20
Universal end panel 750x540	23.1631	76.00	91.20
Carronite end panel 750x540	23.1441	100.00	120.00

*No shower screen available.

The Alpha/Albany range includes:
Albany 1700 x 700 (P60), Alpha 1800 x 800 (P89)

FEATURES

- Bespoke whirlpool available
- Stocked Carronite 6 jet c lenda whirlpool available, page 170
- Optional headrest available
- No tap holes or waste fittings
- Carronite baths have a 30 year guarantee

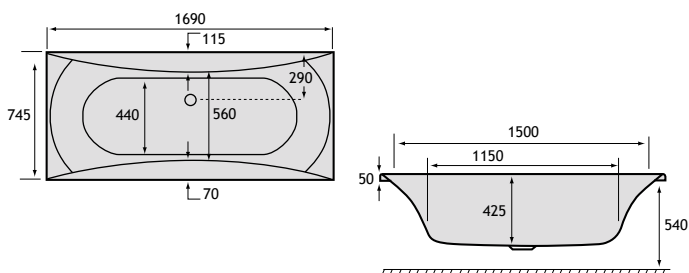

ARC DUO 1700

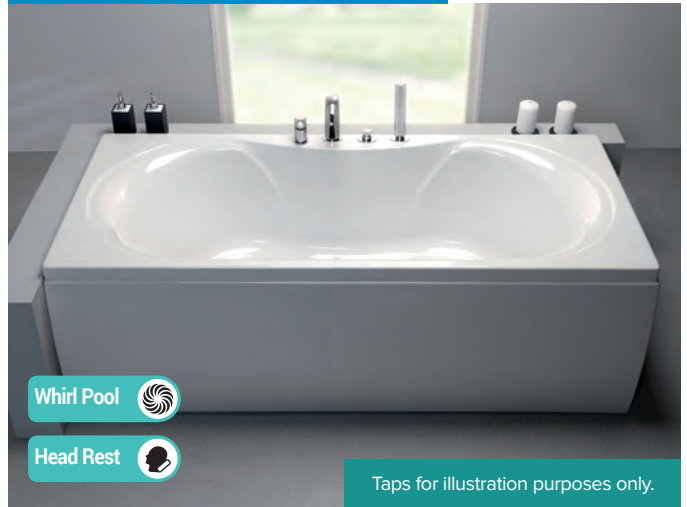

- Whirl Pool 
- Head Rest 

Taps for illustration purposes only.



The Arc Duo has striking contoured lines and the double ended curves.

1700 x 750 x 420 mm		190 Litres	
Description	Code	£ Ex VAT	£ Inc VAT
1700 x 750 5mm	23.4621	277.00	332.40
1700 x 750 Carronite	23.5621	474.00	568.80

PANELS

L shaped C/nite 1700x750x540	57.1061	276.00	331.20
Quantum panel 1700x540	23.3261	107.00	128.40
Concord panel 1700 x 540	23.1571	108.00	129.60
Quantum C/nite 1700x540	23.3311	138.00	165.60
Carronite panel 1700 x 540	23.1381	146.00	175.20
Universal end panel 750x540	23.1631	76.00	91.20
Carronite end panel 750x540	23.1441	100.00	120.00

*No shower screen available.



Also available in the Arc double-ended range:
1800 x 800 (P90)

FEATURES

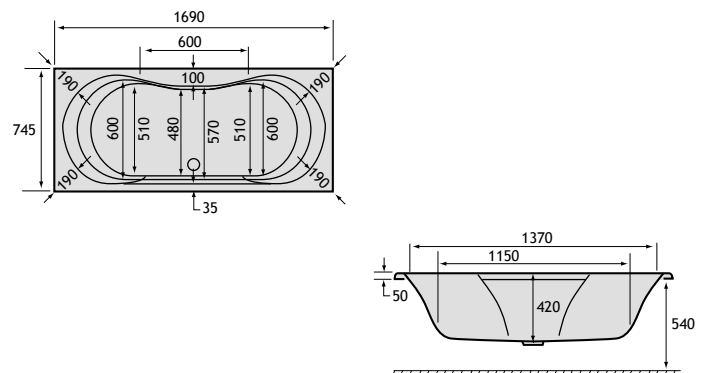
- Bespoke whirlpool available
- No tap holes or waste fittings
- Optional headrest available
- Carronite baths have a 30 year guarantee



ARC SINGLE ENDED

- Whirl Pool 
- Shower 
- Head Rest 



A modern design, single ended bath with a wide curved end for comfort and luxury in bathing, with generous space for showering.

1700 x 750 x 420 mm		195 Litres	
Description	Code	£ Ex VAT	£ Inc VAT
1700 x 750 5mm	23.4611	277.00	332.40
1700 x 750 Carronite	23.5611	474.00	568.80

PANELS



L shaped C/nite 1700x750x540	57.1061	276.00	331.20
Quantum panel 1700x540	23.3261	107.00	128.40
Concord panel 1700 x 540	23.1571	108.00	129.60
Quantum C/nite 1700x540	23.3311	138.00	165.60
Carronite panel 1700 x 540	23.1381	146.00	175.20
Universal end panel 750x540	23.1631	76.00	91.20
Carronite end panel 750x540	23.1441	100.00	120.00

Also available in the Arc single-ended range: 1500 (P48), 1700 x 700 (P61)

FEATURES

- Bespoke whirlpool available
- Suitable for showering
- No tap holes or waste fittings
- Carronite baths have a 30 year guarantee

BRITANNIA CLASSIC SUPER DEEP

- Whirl Pool 
- Head Rest 



Exclusive to Eastbrook, this bath was produced as a result of public demand. It offers an amazing bathing area in terms of both depth and width, therefore it is ideally suited for c-lenda hydrotherapy.

1700 x 750 x 460mm		210 Litres	
Description	Code	£ Ex VAT	£ Inc VAT
1700 x 750 5mm	23.0901	426.00	511.20
1700 x 750 Carronite	23.2901	668.00	801.60



PANELS

L shaped C/nite 1700x750x540	57.1061	276.00	331.20
Quantum panel 1700x540	23.3261	107.00	128.40
Concord panel 1700 x 540	23.1571	108.00	129.60
Quantum C/nite 1700x540	23.3311	138.00	165.60
Carronite panel 1700 x 540	23.1381	146.00	175.20
Universal end panel 750x540	23.1631	76.00	91.20
Carronite end panel 750x540	23.1441	100.00	120.00

FEATURES

- Bespoke whirlpool available
- Stocked Carronite 6 jet c lenda whirlpool available, page 168
- No tap holes or waste fittings
- Carronite baths have a 30 year guarantee

CLASSIC SHOWERBATH

- Shower 
- Head Rest 



Narrower version of the original shower bath with a design based on the Delta theme.

1700 x 750 x 430mm		195 Litres	
Description	Code	£ Ex VAT	£ Inc VAT
1700 x 750 5mm	23.4341	366.00	439.20
1700 x 750 Carronite	23.5341	579.00	694.80
Headrest HR800	23.312	106.00	127.20

PANELS

L shaped C/nite 1700x750x540	57.1061	276.00	331.20
Quantum panel 1700x540	23.3261	107.00	128.40
Concord panel 1700 x 540	23.1571	108.00	129.60
Quantum C/nite 1700x540	23.3311	138.00	165.60
Carronite panel 1700 x 540	23.1381	146.00	175.20
Universal end panel 750x540	23.1631	76.00	91.20
Carronite end panel 750x540	23.1441	100.00	120.00

FEATURES

- Optional headrest available
- Ideal for showering
- No tap holes or waste fittings
- Carronite baths have a 30 year guarantee

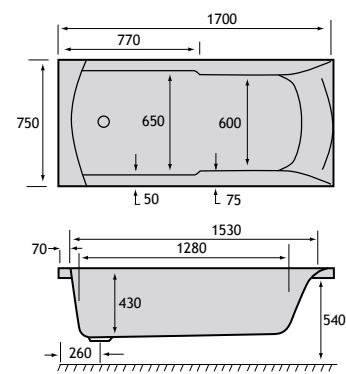
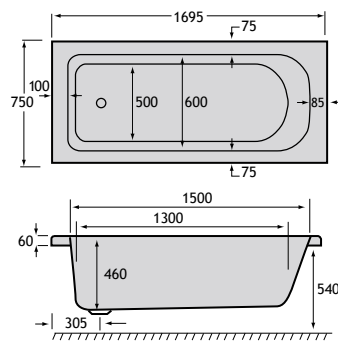
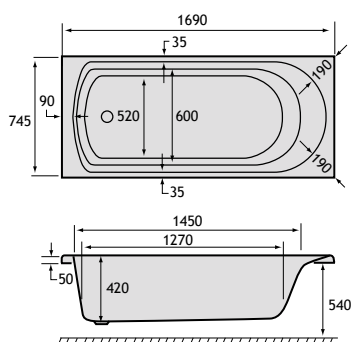

1700

EQUITY 1700

Whirl Pool 

Head Rest 



Taps for illustration purposes only

A spacious double ended bath in both 1700 and 1800mm with an integral tap ledge.

1700 x 750 x 420mm	204 Litres		
Description	Code	£ Ex VAT	£ Inc VAT
1700 x 750 5mm	23.0024	459.00	550.80
1700 x 750 Carronite	23.2024	735.00	882.00

PANELS

Description	Code	£ Ex VAT	£ Inc VAT
L shaped C/nite 1700x750x540	57.1061	276.00	331.20
Quantum panel 1700x540	23.3261	107.00	128.40
Concord panel 1700 x 540	23.1571	108.00	129.60
Quantum C/nite 1700x540	23.3311	138.00	165.60
Carronite panel 1700 x 540	23.1381	146.00	175.20
Universal end panel 750x540	23.1631	76.00	91.20
Carronite end panel 750x540	23.1441	100.00	120.00

Also available in the Equity range:
1800 x 800 (P91)

FEATURES

- Integral tap ledge
- Bespoke whirlpool available
- No tap holes or waste fittings
- Carronite baths have a 30 year guarantee

Head-rests available for all baths



Description	Code	£ Ex VAT	£ Inc VAT
Universal foam headrest	84.0001	28.00	33.60
Universal PU Gel Headrest	84.0000	55.00	66.00

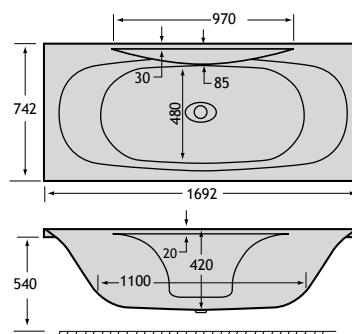

PROFILE 1700

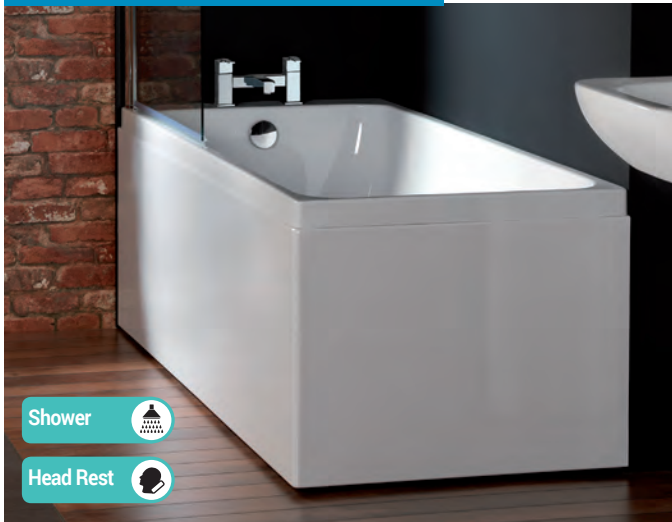

- Shower 
- Head Rest 



A modern bath with a 33mm ledge on three sides for a sleek minimalist look and optimum bathing space.

1700 x 750 x 400mm	257 Litres		
Description	Code	£ Ex VAT	£ Inc VAT
Profile 1700x750 5mm	23.0044	328.00	393.60
Profile 1700x750 Cnite	23.2044	567.00	680.40

PANELS

L shaped C/nite 1700x750x540	57.1061	276.00	331.20
Quantum panel 1700x540	23.3261	107.00	128.40
Concord panel 1700 x 540	23.1571	108.00	129.60
Quantum C/nite 1700x540	23.3311	138.00	165.60
Carronite panel 1700 x 540	23.1381	146.00	175.20
Universal end panel 750x540	23.1631	76.00	91.20
Carronite end panel 750x540	23.1441	100.00	120.00

BATH SCREENS

Corniche 8mm 800x1400	69.0142	212.00	254.40
Volente 6mm 850x1500	58.702	158.00	189.60
Volente 8mm 850x1500	58.703	163.00	195.60

Also available in the Profile range:
1500 (P50), 1600 (P54), 1700 x 700 (P65)

FEATURES

- No tap holes or waste fittings
- Carronite baths have a 30 year guarantee
- Optional headrest available

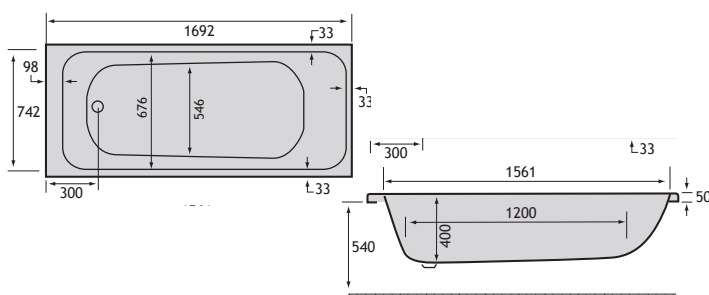

PROFILE DUO 1700

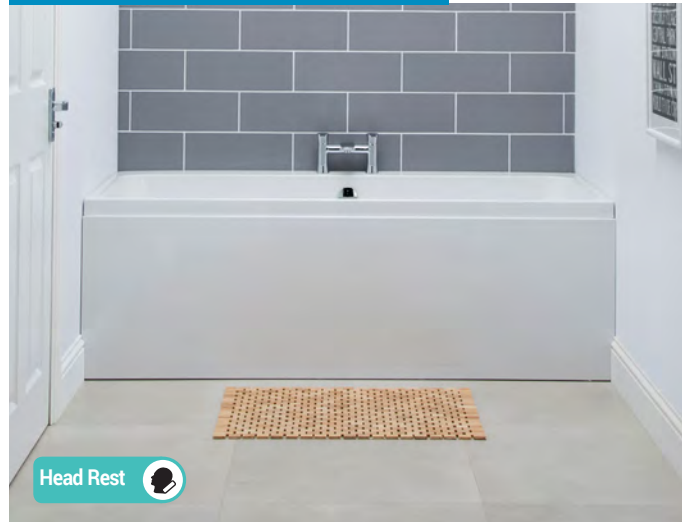

- Head Rest 



Taking the popular Profile range to a new level of luxury with a double ended option.

1700 x 750 x 410mm	230 Litres		
Description	Code	£ Ex VAT	£ Inc VAT
Profile 1700x750 Duo 5mm	23.0057	328.00	393.60
Profile 1700x750 Duo C/nite	23.2057	567.00	680.40

PANELS

L shaped C/nite 1700x750x540	57.1061	276.00	331.20
Quantum panel 1700x540	23.3261	107.00	128.40
Concord panel 1700 x 540	23.1571	108.00	129.60
Quantum C/nite 1700x540	23.3311	138.00	165.60
Carronite panel 1700 x 540	23.1381	146.00	175.20
Universal end panel 750x540	23.1631	76.00	91.20
Carronite end panel 750x540	23.1441	100.00	120.00

*No bath screen available.

Also available in the Profile Duo range:
1600 x 700 (P54), 1650 x 700 (P58), 1700 x 700 (P66) 1800 x 700 (P87)

FEATURES

- No tap holes or waste fittings
- Carronite baths have a 30 year guarantee
- Optional headrest available

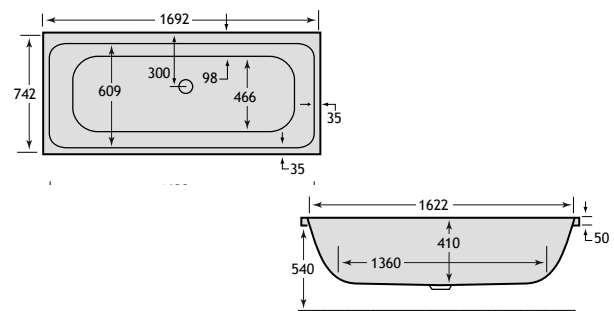

1700

QUANTUM DUO 1700 X 750



- Shower
- Whirl Pool
- Head Rest

Modern and minimalist version of a double ended bath. The straight sides and sloping backs give a spacious bathing area. It has a central waste and overflow below the tap ledge and is suitable for a bath screen.

1700 x 750 x 430mm		190 Litres	
Description	Code	£ Ex VAT	£ Inc VAT
1700 x 750 5mm	23.4701	283.00	339.60
1700 x 750 Carronite	23.5701	485.00	582.00
HR900 headrest	23.309	106.00	127.20

PANELS			
Description	Code	£ Ex VAT	£ Inc VAT
L shaped C/nite 1700x750x540	57.1061	276.00	331.20
Quantum panel 1700x540	23.3261	107.00	128.40
Concord panel 1700 x 540	23.1571	108.00	129.60
Quantum C/nite 1700x540	23.3311	138.00	165.60
Carronite panel 1700 x 540	23.1381	146.00	175.20
Universal end panel 750x540	23.1631	76.00	91.20
Carronite end panel 750x540	23.1441	100.00	120.00

Also available in the Quantum Duo range:
1700 x 700/800 (P66/82), 1800 x 800 (P92), 1900 x 900 (P95)

FEATURES

- Optional headrest available
- Stocked Carronite 6 jet c lenda whirlpool available, page 169
- Bespoke whirlpool available
- Suitable for showering
- No tap holes or waste fittings

QUANTUM DUO INTEGRA



- Shower
- Whirl Pool
- Grips
- Head Rest

The popular Quantum Duo is now available with an integral grip opposite the waste and overflow.

1700 x 750 x 430mm		190 Litres	
Description	Code	£ Ex VAT	£ Inc VAT
1700 x 750 5mm Integra	23.4981	324.00	388.80
1700 x 750 Carronite Integra	23.5981	524.00	628.80
HR900 Headrest	23.309	106.00	127.20

PANELS			
Description	Code	£ Ex VAT	£ Inc VAT
L shaped C/nite 1700x750x540	57.1061	276.00	331.20
Quantum panel 1700x540	23.3261	107.00	128.40
Concord panel 1700 x 540	23.1571	108.00	129.60
Quantum C/nite 1700x540	23.3311	138.00	165.60
Carronite panel 1700 x 540	23.1381	146.00	175.20
Universal end panel 750x540	23.1631	76.00	91.20
Carronite end panel 750x540	23.1441	100.00	120.00

Integra can only be fitted with an acrylic panel.

Also available in the Quantum Duo range:
1700 x 700/800 (P66/82),
1800 x 800 (P92), 1900 x 900 (P95)

FEATURES

- Bespoke whirlpool available
- Suitable for showering
- Integral grip opposite tap and waste
- No tap holes or waste fittings
- Carronite baths have a 30 year guarantee
- Optional headrest available

QUANTUM SE 1700 X 750



- Shower
- Whirl Pool
- Head Rest

A new design single ended bath with straight sides and minimalist lines maximising both bath and showering space. For gripped version see page 65.

1700 x 750 x 430mm		240 Litres	
Description	Code	£ Ex VAT	£ Inc VAT
1700 x 750 5mm	23.4671	283.00	339.60
1700 x 750 Carronite	23.5671	485.00	582.00
HR900 headrest	23.309	106.00	127.20

PANELS			
Description	Code	£ Ex VAT	£ Inc VAT
L shaped C/nite 1700x750x540	57.1061	276.00	331.20
Quantum panel 1700x540	23.3261	107.00	128.40
Concord panel 1700 x 540	23.1571	108.00	129.60
Quantum C/nite 1700x540	23.3311	138.00	165.60
Carronite panel 1700 x 540	23.1381	146.00	175.20
Universal end panel 750x540	23.1631	76.00	91.20
Carronite end panel 750x540	23.1441	100.00	120.00



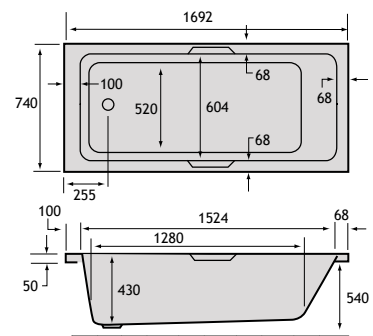
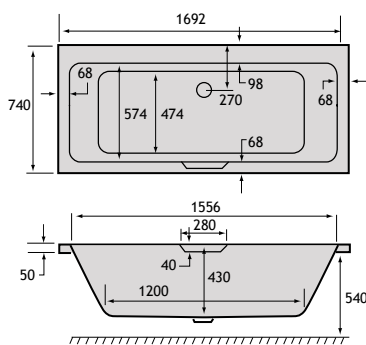
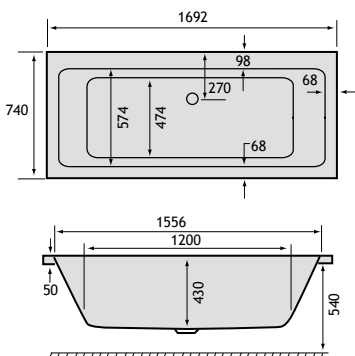

Also available in the Quantum SE range:
1500 x 700 (P51), 1600 x 700 (P55), 1600 x 700 (P57), 1700 x 700/800/900 (P66/82/84), 1800 x 725 (P86), 1800 x 800 (P92)

FEATURES

- Optional headrest available
- Stocked Carronite 6 jet c lenda whirlpool available, page 170
- Bespoke whirlpool available
- Suitable for showering
- No tap holes or waste fittings
- Carronite baths have a 30 year guarantee



SIGMA 1700 X 750

- Shower 
- Whirl Pool 
- Grips 
- Head Rest 



A wider version of the Delta 1700.

1700 x 750 x 440mm		195 Litres	
Description	Code	£ Ex VAT	£ Inc VAT
1700 x 750 5mm	23.0031	388.00	465.60
1700 x 750 Carronite	23.2031	624.00	748.80
1700 x 750 TG 5mm	23.4251	429.00	514.80
1700 x 750 TG Carronite	23.5251	665.00	798.00
Headrest HR800	23.312	106.00	127.20

PANELS

L shaped C/nite 1700x750x540	57.1061	276.00	331.20
Quantum panel 1700x540	23.3261	107.00	128.40
Concord front panel 1700 x 540	23.1571	108.00	129.60
Quantum C/nite 1700x540	23.3311	138.00	165.60
Carronite panel 1700 x 540	23.1381	146.00	175.20
Universal end panel 750x540	23.1631	76.00	91.20
Carronite end panel 750x540	23.1441	100.00	120.00

Also available in the Sigma range:
1600 (P57), 1700 x 800 (P82), 1800 (P93), 1900 (P95)

FEATURES

- Available with chrome twin grips
- Stocked Carronite 6 jet c lenda whirlpool available, page 170
- Optional headrest available
- Bespoke whirlpool available
- Suitable for showering
- No tap holes or waste fittings
- Carronite baths have a 30 year guarantee

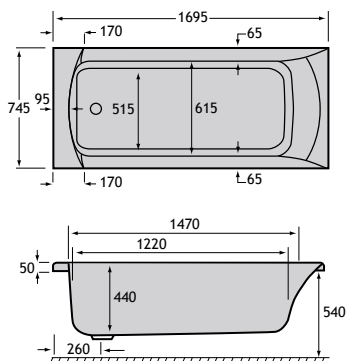

QUANTUM SINGLE ENDED INTEGRA



The Integra features an integrated grip for added safety and has been designed to complement the sleek, modern lines of the original Quantum design.

1700 x 750 x 430mm		240 Litres	
Description	Code	£ Ex VAT	£ Inc VAT
1700 x 750 TG 5mm	23.0016	324.00	388.80
1700 x 750 TG Carronite	23.2016	524.00	628.80
HR900 Black headrest	23.309	106.00	127.20

PANELS

L shaped C/nite 1700x750x540	57.1061	276.00	331.20
Quantum panel 1700x540	23.3261	107.00	128.40
Concord front panel 1700x540	23.1571	108.00	129.60
Quantum C/nite panel 1700x540	23.3311	138.00	165.60
Carronite front panel 1700x540	23.1381	146.00	175.20
Universal end panel 750x540	23.1631	76.00	91.20
Carronite end panel 750x540	23.1441	100.00	120.00

BATH SCREENS





Corniche 8mm 800x1400	69.0142	212.00	254.40
Volente 6mm 850x1500	58.702	158.00	189.60
Volente 8mm 850x1500	58.703	163.00	195.60

Also available in the Quantum Integra range:
1500 (P51), 1600 (P56), 1650 (P59), 1700 x 700/800 (P68/81), 1800 x 800 (P92)

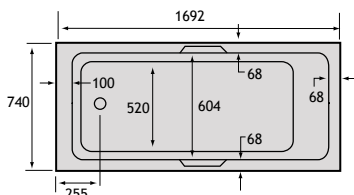
FEATURES

- Chrome twin grips
- Bespoke whirlpool available
- Suitable for showering
- No tap holes or waste fittings
- Carronite baths have a 30 year guarantee



- Shower 
- Whirl Pool 
- Grips 
- Head Rest 



Head-rests available for all baths



Description	Code	£ Ex VAT	£ Inc VAT
Universal foam headrest	84.0001	28.00	33.60
Universal PU Gel Headrest	84.0000	55.00	66.00

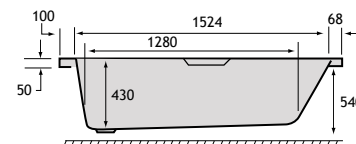

1700

VERONA 1700

A spacious bath designed for rest and luxury, the Verona is extremely comfortable and adaptable. It comes complete with a raised head area and twin handgrips.

1700 x 750 x 410mm **180 litres**

Description	Code	£ Ex VAT	£ Inc VAT
1700 x 750 TG 5mm	23.0201	378.00	453.60
1700 x 750 TG Carronite	23.2201	641.00	769.20

PANELS

L shaped C/nite 1700x750x540	57.1061	276.00	331.20
Quantum panel 1700x540	23.3261	107.00	128.40
Concord panel 1700 x 540	23.1571	108.00	129.60
Quantum C/nite 1700x540	23.3311	138.00	165.60
Carronite panel 1700 x 540	23.1381	146.00	175.20
Universal end panel 750x540	23.1631	76.00	91.20
Carronite end panel 750x540	23.1441	100.00	120.00

Grips

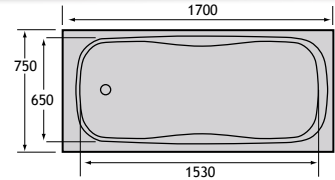
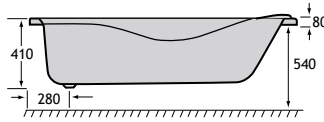

FEATURES

- Chrome twin grips
- Stylish raised head area

- No tap holes or waste fittings
- Carronite baths have a 30 year guarantee

ZONE 1700

An innovative new idea in shower baths featuring a unique circular standing area making this bath ideal as a shower bath.

1700 x 750 x 415mm **224 litres**

Description	Code	£ Ex VAT	£ Inc VAT
Showerbath 1700 x 750 5mm	23.4961	405.00	486.00
Showerbath 1700 x 750 C/nite	23.5961	663.00	795.60
Radius corner screen	69.702	155.00	186.00
Headrest HR700	23.311	106.00	127.20

PANELS

L shaped C/nite 1700x750x540	57.1061	276.00	331.20
Quantum panel 1700x540	23.3261	107.00	128.40
Concord panel 1700 x 540	23.1571	108.00	129.60
Quantum C/nite 1700x540	23.3311	138.00	165.60
Carronite panel 1700 x 540	23.1381	146.00	175.20
Universal end panel 750x540	23.1631	76.00	91.20
Carronite end panel 750x540	23.1441	100.00	120.00

Shower



Head Rest

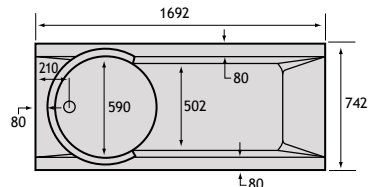
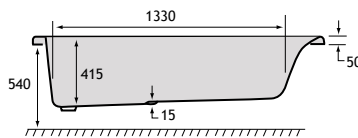

Also available in the Zone range:
1800 x 800 (P94)

FEATURES

- Ideal for showering
- No tap holes or waste fittings
- Carronite baths have a 30 year guarantee

APEX 1700

A wider version of the popular Matrix bath, maximising both bathing and showering area. Available with or without twin grips.

1700 x 800 x 430mm **210 litres**

Description	Code	£ Ex VAT	£ Inc VAT
1700 x 800 plain 5mm	23.4741	402.00	482.40
1700 x 800 TG 5mm	23.4751	432.00	518.40
1700 x 800 plain Carronite	23.5751	679.00	814.80
1700 x 800 TG Carronite	23.5761	709.00	850.80
Headrest HR800	23.312	106.00	127.20

PANELS

Quantum panel 1700x540	23.3261	107.00	128.40
Concord panel 1700 x 540	23.1571	108.00	129.60
Quantum C/nite 1700x540	23.3311	138.00	165.60
Carronite panel 1700 x 540	23.1381	146.00	175.20
Universal end panel 800x540	23.1641	76.00	91.20
Carronite end panel 800x540	23.1451	96.00	115.20

Shower



Grips



Head Rest

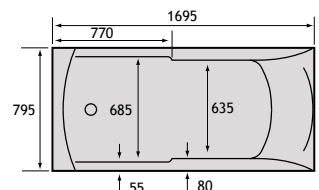
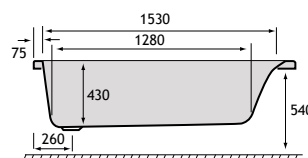

FEATURES

- Chrome twin grips
- Optional headrest available
- Suitable for showering

- No tap holes or waste fittings
- Carronite baths have a 30 year guarantee

HAIKU 1700

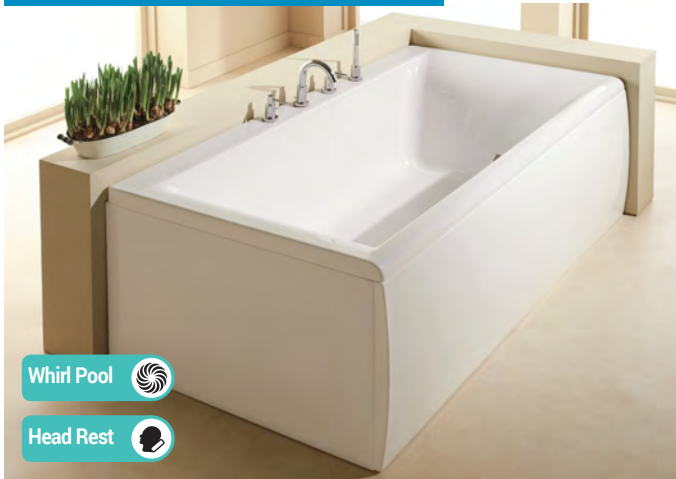

Whirl Pool

Head Rest



An elegant minimalist bath with many straight lines and small radius curves with a gentle sloping backrest.

1700 x 800 x 450mm		220 Litres	
Description	Code	£ Ex VAT	£ Inc VAT
1700 x 800 5mm	23.4321	480.00	576.00
1700 x 800 Carronite	23.5321	800.00	960.00
Headrest HR700	23.311	106.00	127.20

PANELS			
Quantum panel 1700x540	23.3261	107.00	128.40
Concord panel 1700 x 540	23.1571	108.00	129.60
Quantum C/nite 1700x540	23.3311	138.00	165.60
Carronite panel 1700 x 540	23.1381	146.00	175.20
Universal end panel 800x540	23.1641	76.00	91.20
Carronite end panel 800x540	23.1451	96.00	115.20

Also available in the Haiku range:
1800 x 800 (P91), 1800 x 900 (P94)

FEATURES

- Optional headrest available
- Bespoke whirlpool available
- No tap holes or waste fittings
- Carronite baths have a 30 year guarantee
- Can be fitted with an overflow filler 2.015

Head-rests available for all baths



Description	Code	£ Ex VAT	£ Inc VAT
Universal foam headrest	84.0001	28.00	33.60
Universal PU Gel Headrest	84.0000	55.00	66.00

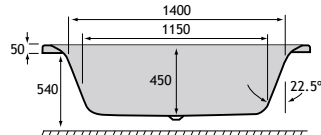
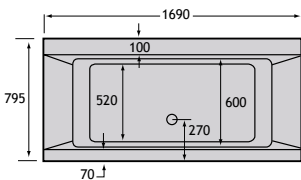

QUANTUM SINGLE ENDED INTEGRA

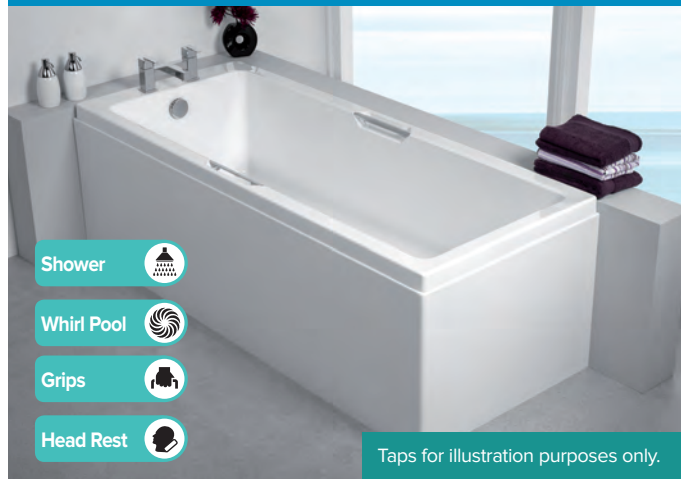

Shower

Whirl Pool

Grips

Head Rest

Taps for illustration purposes only.



Combining the added safety and security, that comes with a gripped bath, with the sleek, modern lines of the existing Quantums. The Integra features an integrated grip that has been designed to complement the original Quantum design.

1700 x 800 x 440mm		267 Litres	
Description	Code	£ Ex VAT	£ Inc VAT
1700 x 800 TG 5mm	23.0028	347.00	416.40
1700 x 800 TG Carronite	23.2028	540.00	648.00
HR900 Black headrest	23.309	106.00	127.20

PANELS			
Quantum panel 1700x540	23.3261	107.00	128.40
Concord panel 1700 x 540	23.1571	108.00	129.60
Quantum C/nite 1700x540	23.3311	138.00	165.60
Carronite panel 1700 x 540	23.1381	146.00	175.20
Universal end panel 800x540	23.1641	76.00	91.20
Carronite end panel 800x540	23.1451	96.00	115.20

BATH SCREENS			
Corniche 8mm 800x1400	69.0142	212.00	254.40
Volente 6mm 850x1500	58.702	158.00	189.60
Volente 8mm 850x1500	58.703	163.00	195.60

*No bath screen available.

Also available in the Quantum Integra range: 1500 (P51), 1600 (P56), 1650 (P59), 1700 x 700/750 (P68/79), 1800 x 800 (P92)

FEATURES

- Chrome twin grips
- Bespoke whirlpool available
- Suitable for showering
- No tap holes or waste fittings
- Carronite baths have a 30 year guarantee

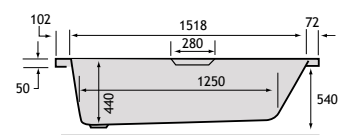
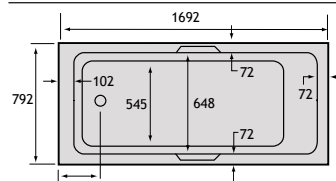

1700

QUANTUM DUO 1700 X 800



- Shower 
- Whirl Pool 
- Head Rest 

Modern and minimalist version of a double ended bath. The straight sides and sloping backs give a spacious bathing area. It has a central waste and overflow below the tap ledge and is suitable for a bath screen.

1700 x 800 x 440mm		200 Litres	
Description	Code	£ Ex VAT	£ Inc VAT
1700 x 800 5mm	23.0027	315.00	378.00
1700 x 800 Carronite	23.2027	506.00	607.20
HR900 headrest	23.309	106.00	127.20

PANELS

Quantum panel 1700x540	23.3261	107.00	128.40
Concord panel 1700 x 540	23.1571	108.00	129.60
Quantum C/nite 1700x540	23.3311	138.00	165.60
Carronite panel 1700 x 540	23.1381	146.00	175.20
Universal end panel 800x540	23.1641	76.00	91.20
Carronite end panel 800x540	23.1451	96.00	115.20

Also available in the Quantum Duo range: 1700 x 700/750 (P66/78), 1800 x 800 (P92), 1900 x 900 (P95)

FEATURES

- Optional headrest available
- Bespoke whirlpool available
- Suitable for showering
- No tap holes or waste fittings
- Carronite baths have a 30 year guarantee

QUANTUM SE 1700 X 800



- Shower 
- Whirl Pool 
- Head Rest 

A new design single ended bath with straight sides and minimalist lines maximising both bath and showering space.

1700 x 800 x 440mm		267 Litres	
Description	Code	£ Ex VAT	£ Inc VAT
1700 x 800 5mm	23.4921	315.00	378.00
1700 x 800 Carronite	23.5921	506.00	607.20
HR900 headrest	23.309	106.00	127.20

PANELS

Quantum panel 1700x540	23.3261	107.00	128.40
Concord panel 1700 x 540	23.1571	108.00	129.60
Quantum C/nite 1700x540	23.3311	138.00	165.60
Carronite panel 1700 x 540	23.1381	146.00	175.20
Universal end panel 800x540	23.1641	76.00	91.20
Carronite end panel 800x540	23.1451	96.00	115.20





Also available in the Quantum SE range: 1500 x 700 (P51), 1600 x 700 (P55), 1600 x 700 (P57), 1700 x 700/800/900 (P66/82/84), 1800 x 725 (P86), 1800 x 800 (P92)

FEATURES

- Optional headrest available
- Bespoke whirlpool available
- Suitable for showering
- No tap holes or waste fittings
- Carronite baths have a 30 year guarantee

SIGMA 1700 X 800



- Shower 
- Whirl Pool 
- Grips 
- Head Rest 

A wider version of the Delta 1700.

1700 x 800 x 450mm		195 Litres	
Description	Code	£ Ex VAT	£ Inc VAT
1700 x 800 5mm	23.4061	434.00	520.80
1700 x 800 Carronite	23.5061	762.00	914.40
1700 x 800 TG 5mm	23.4261	475.00	570.00
1700 x 800 TG Carronite	23.5261	803.00	963.60
Headrest HR800	23.312	106.00	127.20

PANELS

Quantum panel 1700x540	23.3261	107.00	128.40
Concord panel 1700 x 540	23.1571	108.00	129.60
Quantum C/nite 1700x540	23.3311	138.00	165.60
Carronite panel 1700 x 540	23.1381	146.00	175.20
Universal end panel 800x540	23.1641	76.00	91.20
Carronite end panel 800x540	23.1451	96.00	115.20

Also available in the Sigma range: 1600 (P57), 1700 x 750 (P79), 1800 (P93), 1900 (P95)

FEATURES

- Available with chrome twin grips
- Optional headrest available
- Bespoke whirlpool available
- Suitable for showering
- No tap holes or waste fittings
- Carronite baths have a 30 year guarantee

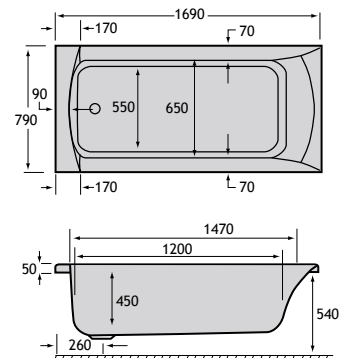
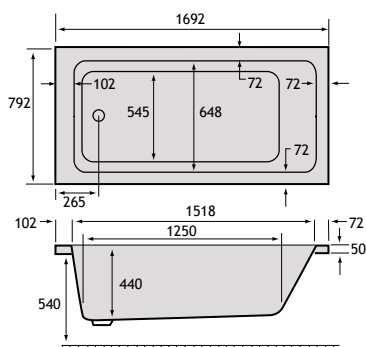
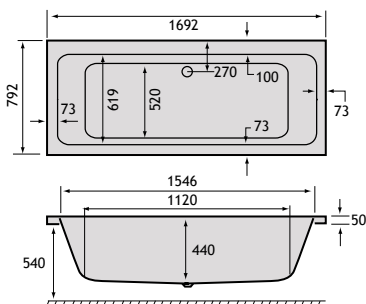

STATUS 1700



Whirl Pool 

Head Rest 

Taps for illustration purposes only. This bath has a suspended panel. Left hand shown, bath to be fitted in a corner situation only.

Bringing a unique perspective to bathroom design the Status adds a touch of luxury with its soft curves and ideal proportions.

1700 x 800 x 450mm		250 Litres	
Description	Code	£ Ex VAT	£ Inc VAT
1700 x 800 5mm RH	23.4371R	501.00	601.20
1700 x 800 5mm LH	23.4371L	501.00	601.20
1700 x 800 Carronite RH	23.5371R	804.00	964.80
1700 x 800 Carronite LH	23.5371L	804.00	964.80

PANELS

1700 x 800 x 540 Panel	23.1751	201.00	241.20
1700 x 800 x 540 Carronite panel	23.1951	285.00	342.00

*No shower screen available.

Also available in the Status range:
Status showerbath 1550 x 850 (P101),
1600 x 725 (P57), 1700 x 785 (P69)

FEATURES

- Bespoke whirlpool available
- Stocked Carronite 6 jet c lenda whirlpool available, page 169
- No tap holes or waste fittings
- Carronite baths have a 30 year guarantee
- Can be fitted with an overflow filler 2.015

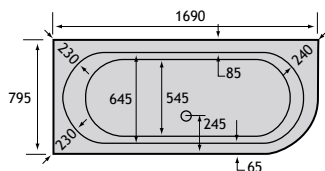

Right hand shown.

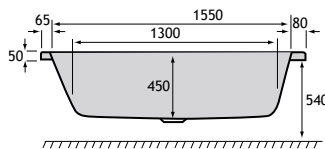

LEFT HAND SHOWN



COMPLETE THE LOOK

Status Cast Top Basins

Flip to the Vanity section to find your ideal Status basin size: Status 39 (P329), Status 44 (P331), Status 58 (P335)



1700 & 1745

QUANTUM SE 1700 X 900

Shower 

Whirl Pool 

Head Rest 



A new design single ended bath with straight sides and minimalist lines maximising both bath and showering space.

1700 x 900 x 440mm		318 Litres	
Description	Code	£ Ex VAT	£ Inc VAT
1700 x 900 5mm	23.0064	420.00	504.00
1700 x 900 Carronite	23.2064	646.00	775.20
HR900 headrest	23.309	106.00	127.20

PANELS

Quantum panel 1700x540	23.3261	107.00	128.40
Concord panel 1700 x 540	23.1571	108.00	129.60
Quantum C/nite 1700x540	23.3311	138.00	165.60
Carronite panel 1700 x 540	23.1381	146.00	175.20
Carronite end panel 900x540	23.1461	109.00	130.80

FEATURES

- Optional headrest available
- Bespoke whirlpool available
- Suitable for showering
- No tap holes or waste fittings
- Carronite baths have a 30 year guarantee
- Can be fitted with an overflow filler 2.015

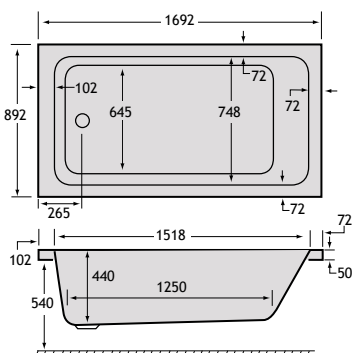

HALCYON D

Head Rest 



Shown with granite panel, also available in white.

A stylish modern redesign of the Halcyon Round for a single sided installation.

1745 x 800 x 450mm		253 Litres	
Description	Code	£ Ex VAT	£ Inc VAT
Halcyon D 1745x800 5mm	23.0036	465.00	558.00
Halcyon D 1745x800 Cnite	23.2036	825.00	990.00

PANELS

Halcyon D Panel white	23.1006	437.00	524.40
Halcyon D panel granite	23.1015	523.00	627.60

This bath has a suspended panel.

FEATURES

- No tap holes or waste fittings
- Carronite baths have a 30 year guarantee

Head-rests available for all baths



Description	Code	£ Ex VAT	£ Inc VAT
Universal foam headrest	84.0001	28.00	33.60
Universal PU Gel Headrest	84.0000	55.00	66.00

Head Rest 

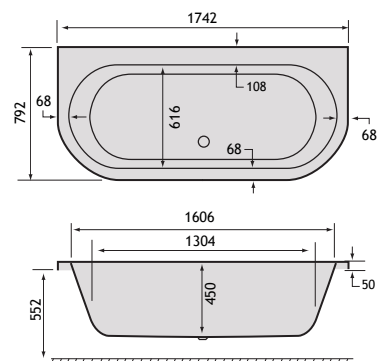

1750 & 1800

HALCYON ROUND 1750



Head Rest 

A new concept and design in built-in situations featuring double-ended style for luxury bathing. Also available in free standing option. See page 122.

1750 x 800 x 450mm		270 Litres	
Description	Code	£ Ex VAT	£ Inc VAT
1750 x 800 5mm Inset	23.4401	465.00	558.00
1750 x 800 Carronite Inset	23.5401	825.00	990.00

FEATURES

- No tap holes or waste fittings
- Carronite baths have a 30 year guarantee

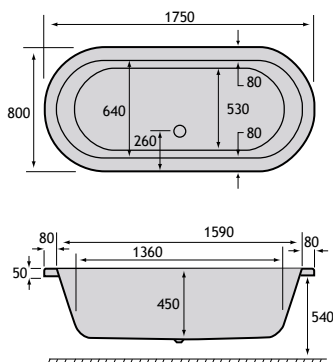

Head Rest 



SWALLOW 1800

Grips 

Head Rest 



Unique 700mm wide 1800mm long version of this comfortable bath with a proven pedigree, the Swallow can be found in five star hotels worldwide. Features half length textured base and an integral soap dish.

1800 x 700 x 365mm		185 Litres	
Description	Code	£ Ex VAT	£ Inc VAT
1800 x 700 TG 5mm	23.0581	409.00	490.80
1800 x 700 TG Carronite	23.2581	634.00	760.80

PANELS

L shaped C/nite 1800x800x540*	57.1021	276.00	331.20
Quantum panel 1800x540	23.3271	114.00	136.80
Concord panel 1800 x 540	23.1581	115.00	138.00
Quantum C/nite 1800x540	23.3321	150.00	180.00
Carronite panel 1800 x 540	23.1391	150.00	180.00
Universal end panel 700x540	23.1621	76.00	91.20
Carronite end panel 700x540	23.1431	100.00	120.00
Shallow Profile Bath Filler	2.015	204.00	244.80

*Panel needs to be cut down.

Also available in the Swallow range: 1700 (P68)

FEATURES

- Chrome twin grips
- Integral soap dish
- Half length textured base
- No tap holes or waste fittings
- Carronite baths have a 30 year guarantee
- Can be fitted with an overflow filler 2.015

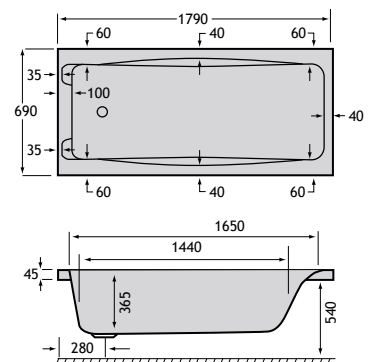

1800

QUANTUM SINGLE ENDED 1800



A new design single ended bath with straight sides and minimalist lines maximising both bath and showering space.

1800 x 725 x 440mm	266 Litres		
Description	Code	£ Ex VAT	£ Inc VAT
1800 x 725 5mm	23.4901	306.00	367.20
1800 x 725 Carronite	23.5901	502.00	602.40
HR900 headrest	23.309	106.00	127.20

PANELS			
Description	Code	£ Ex VAT	£ Inc VAT
L shaped C/nite 1800x800x540*	57.1021	276.00	331.20
Quantum panel 1800x540	23.3271	114.00	136.80
Concord panel 1800 x 540	23.1581	115.00	138.00
Quantum C/nite 1800x540	23.3321	150.00	180.00
Carronite panel 1800 x 540	23.1391	150.00	180.00
Universal end panel 725x540	23.3421	76.00	91.20
Carronite end panel 725x540	23.3431	100.00	120.00

*Panel needs to be cut down.

Also available in the Quantum range: 1500 (P51), 1600 x 700/800 (P55/57), 1700 x 700/750/800/900 (P66/78/82/84), 1800 x 800 (P92)

FEATURES

- No tap holes or waste fittings
- Carronite baths have a 30 year guarantee
- Bespoke whirlpool available

IMPERIAL 1800



Unique 750mm width 1800 version of this popular bath with a full length textured base.

1800 x 750 x 420mm	210 Litres		
Description	Code	£ Ex VAT	£ Inc VAT
1800 x 750 TG 5mm	23.4311	456.00	547.20
1800 x 750 TG Carronite	23.5311	714.00	856.80
HR900 headrest	23.309	106.00	127.20

PANELS			
Description	Code	£ Ex VAT	£ Inc VAT
L shaped C/nite 1800x800x540*	57.1021	276.00	331.20
Quantum panel 1800x540	23.3271	114.00	136.80
Concord panel 1800 x 540	23.1581	115.00	138.00
Quantum C/nite 1800x540	23.3321	150.00	180.00
Carronite panel 1800 x 540	23.1391	150.00	180.00
Universal end panel 725x540	23.3421	76.00	91.20
Carronite end panel 725x540	23.3431	100.00	120.00

*Panel needs to be cut down.

Also available in the Imperial range: 1400 (P47), 1500 (P49), 1600 (P53), 5'6" (P60), 1700 x 700 (P63)

FEATURES

- Bespoke whirlpool available
- No tap holes or waste fittings
- Carronite baths have a 30 year guarantee
- Full length textured base

EQUATION 1800



A spacious double ended bath with a large central tap ledge to allow for all modern combinations of taps.

1800 x 792 x 430mm	233 Litres		
Description	Code	£ Ex VAT	£ Inc VAT
1800 x 800 5mm	23.4821	460.00	552.00
1800 x 800 Carronite	23.5821	743.00	891.60

PANELS			
Description	Code	£ Ex VAT	£ Inc VAT
L shaped C/nite 1800x800x540*	57.1021	276.00	331.20
Quantum panel 1800x540	23.3271	114.00	136.80
Concord panel 1800 x 540	23.1581	115.00	138.00
Quantum C/nite 1800x540	23.3321	150.00	180.00
Carronite panel 1800 x 540	23.1391	150.00	180.00
Universal end panel 725x540	23.3421	76.00	91.20
Carronite end panel 725x540	23.3431	100.00	120.00

Also available in the Equation range: 1700 x 740 (P70)

FEATURES

- Bespoke whirlpool available
- Stocked Carronite 6 jet c lenda whirlpool available, page 168
- No tap holes or waste fittings
- Carronite baths have a 30 year guarantee

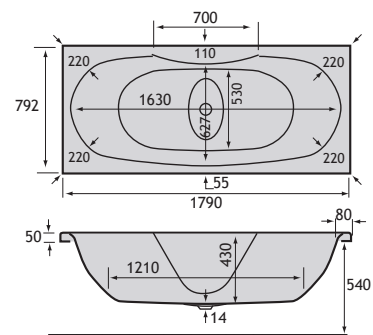
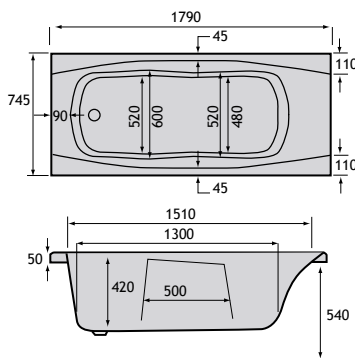
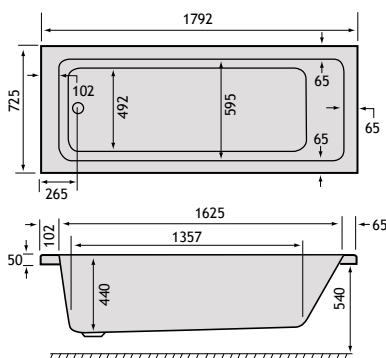

PROFILE



PROFILE SINGLE ENDED 1800 X 700



A modern bath with a 33mm ledge on three sides for a sleek minimalist look and optimum bathing space.

1800 x 700 x 400mm		255 Litres	
Description	Code	£ Ex VAT	£ Inc VAT
1800 x 700 5mm	23.6027	343.00	411.60
1800 x 700 Carronite	23.6028	598.00	717.60

PANELS

L shaped C/nite 1800x800x540	57.1021	276.00	331.20
Quantum panel 1800x540	23.3271	114.00	136.80
Concord panel 1800 x 540	23.1581	115.00	138.00
Quantum C/nite 1800x540	23.3321	150.00	180.00
Carronite panel 1800 x 540	23.1391	150.00	180.00
Universal end panel 700x540	23.1621	76.00	91.20
Carronite end panel 700x540	23.1431	100.00	120.00

Also available in the Profile range:
1500 (P50), 1600 (P54), 1700 x 700/750 (P65/77)

FEATURES

- Bespoke whirlpool available
- No tap holes or waste fittings
- Carronite baths have a 30 year guarantee
- Full length textured base

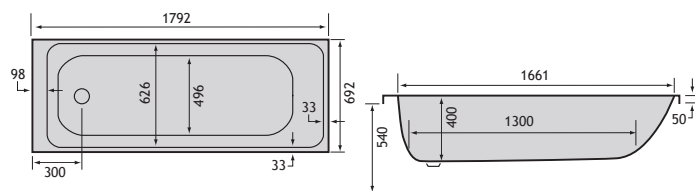

PROFILE DUO 1800 X 700



Taking the popular Profile range to a new level of luxury with a double ended option.

1800 x 700 x 410mm		231 Litres	
Description	Code	£ Ex VAT	£ Inc VAT
1800 x 700 5mm	23.6029	343.00	411.60
1800 x 700 Carronite	23.6030	598.00	717.60

PANELS

L shaped C/nite 1800x800x540	57.1021	276.00	331.20
Quantum panel 1800x540	23.3271	114.00	136.80
Concord panel 1800 x 540	23.1581	115.00	138.00
Quantum C/nite 1800x540	23.3321	150.00	180.00
Carronite panel 1800 x 540	23.1391	150.00	180.00
Universal end panel 700x540	23.1621	76.00	91.20
Carronite end panel 700x540	23.1431	100.00	120.00

Also available in the Profile Duo range:
1600 (P54), 1650 (P58), 1700 x 700/750 (P66/77)

FEATURES

- Bespoke whirlpool available
- No tap holes or waste fittings
- Carronite baths have a 30 year guarantee
- Full length textured base

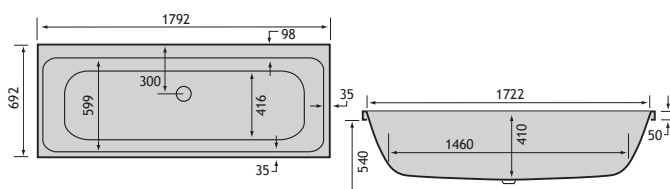

1800

HIGHGATE 1800

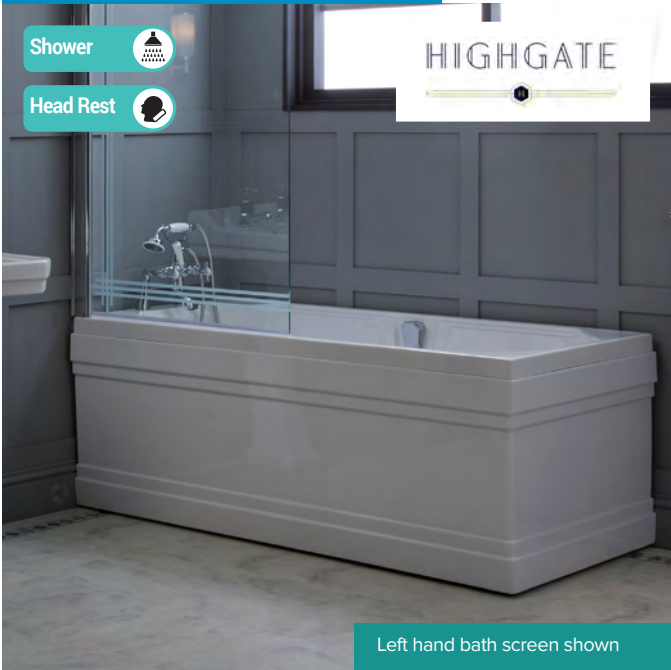

Left hand bath screen shown

HIGHGATE DUO 1800

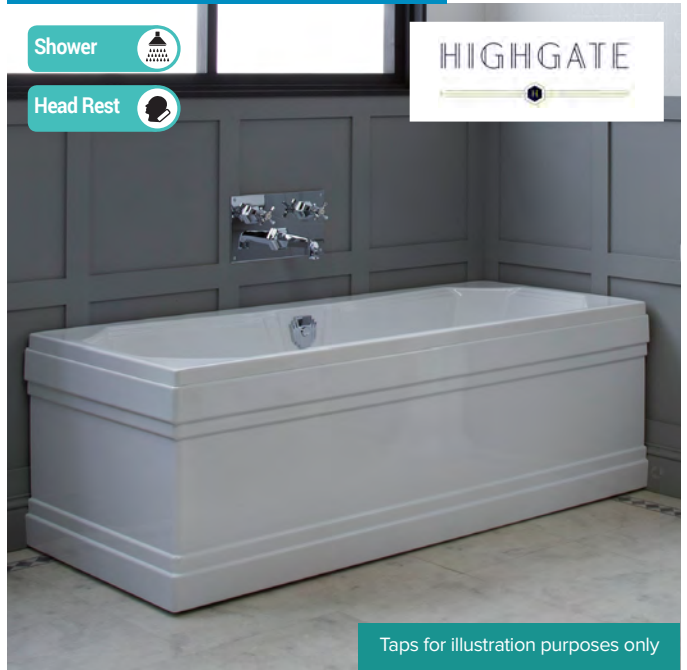

Taps for illustration purposes only



An art deco inspired bath that combines style with functionality.

1800 x 800 x 540mm		268 Litres	
Description	Code	£ Ex VAT	£ Inc VAT
1800 x 800 Carronite SE TG	23.6003	1171.00	1405.20
1800 x 800 Carronite SE Plain*	23.6004	1088.00	1305.60

*While stocks last

PANELS			
1800 x 800 x 540 C/nite L panel	23.6016	281.00	337.20
1800 x 800 x 540 C/nite panel	23.6014	179.00	214.80

SCREENS			
Highgate Screen LH - Etched	23.6017	216.00	259.20
Highgate Screen RH - Etched	23.6018	216.00	259.20

Also available in the Highgate range:
1700 (P72), Highgate Showerbath (P109)

FEATURES

- Waste and overflow fittings supplied
- No tap holes
- Carronite baths have a 30 year guarantee

A double-ended version of the art deco inspired bath that combines style with functionality.

1800 x 800 x 540mm		264 Litres	
Description	Code	£ Ex VAT	£ Inc VAT
1800 x 800 Carronite DE Single Grip	23.6007	1130.00	1356.00
1800 x 800 Carronite DE Plain*	23.6008	1088.00	1305.60

PANELS			
1800 x 800 x 540 C/nite L panel	23.6016	281.00	337.20
1800 x 800 x 540 C/nite panel	23.6014	179.00	214.80

SCREENS			
Highgate Screen LH - Etched	23.6017	216.00	259.20
Highgate Screen RH - Etched	23.6018	216.00	259.20

Also available in the Highgate range:
1700 (P72), Highgate Showerbath (P109)

FEATURES

- Waste and overflow fittings supplied
- No tap holes
- Carronite baths have a 30 year guarantee

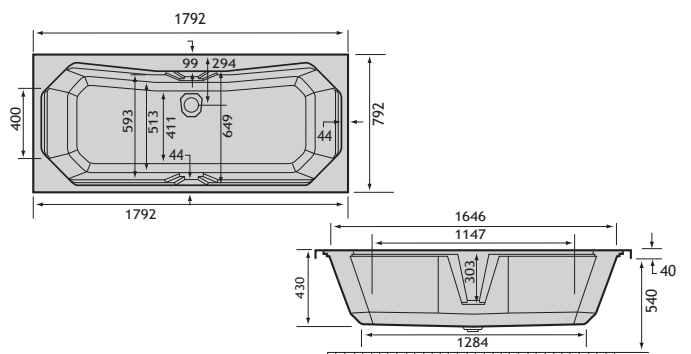
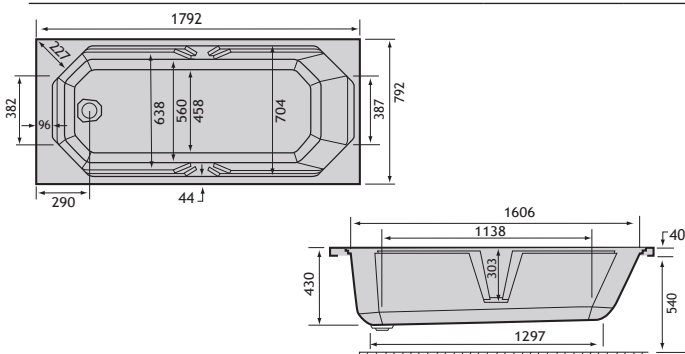

MISTRAL 1800



Another genuine 1800 x 700 but with a designer bow front to 900mm creating our most spacious 1800 double-ended bath.

1800 x 700/900 x 480mm		330 Litres	
Description	Code	£ Ex VAT	£ Inc VAT
1800 x 900 5mm	23.4151	679.00	814.80
1800 x 900 Carronite	23.5151	1084.00	1300.80

PANELS

Front panel	23.1291	172.00	206.40
End panel	23.1271	89.00	106.80

Also available in the Quantum Integra range: 1500 (P51), 1600 (P56), 1650 x 700 (P59), 1700 x 700/800 (P68/81), 1800 x 800 (P92)

FEATURES

- Stylish designer bow front
- No tap holes or waste fittings
- Carronite baths have a 30 year guarantee
- Can be fitted with 2 end panels

Head-rests available for all baths



Description	Code	£ Ex VAT	£ Inc VAT
Universal foam headrest	84.0001	28.00	33.60
Universal PU Gel Headrest	84.0000	55.00	66.00

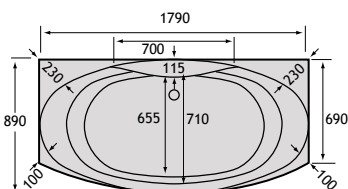

Head Rest

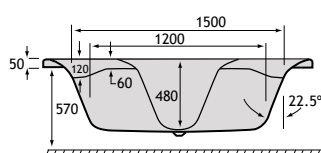

ALPHA 1800

Whirl Pool

Head Rest



This double-ended bath not only provides a spacious comfortable bathing experience but is a stylish addition to a beautiful bathroom.

1800 x 800 x 440mm		220 Litres	
Description	Code	£ Ex VAT	£ Inc VAT
1800 x 800 5mm	23.4111	489.00	586.80
1800 x 800 Carronite	23.5111	764.00	916.80
Alpha 1800 x 800 5mm	23.312	106.00	127.20

PANELS

L shaped C/nite 1800x800x540	57.1021	276.00	331.20
Quantum panel 1800x540	23.3271	114.00	136.80
Concord panel 1800 x 540	23.1581	115.00	138.00
Quantum C/nite 1800x540	23.3321	150.00	180.00
Carronite panel 1800 x 540	23.1391	150.00	180.00
Universal end panel 800x540	23.1641	76.00	91.20
Carronite end panel 800x540	23.1451	96.00	115.20

Also available in the Albany/Alpha range: 1700 x 700 (P60), 1700 x 750 (P74)

FEATURES

- Bespoke whirlpool available
- Stocked Carronite 6 jet c lenda whirlpool available, page 170
- Optional headrest available
- No tap holes or waste fittings

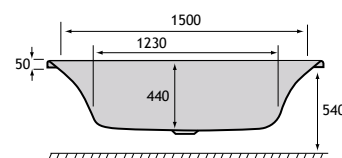
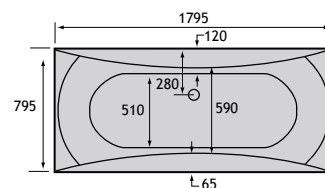

1800

ARC DUO 1800

- Whirl Pool 
- Head Rest 



The Arc Duo has striking contoured lines and the double ended curves allow comfortable, luxurious bathing for two.

1800 x 800 x 430mm		210 litres	
Description	Code	£ Ex VAT	£ Inc VAT
1800 x 800 5mm	23.4631	333.00	399.60
1800 x 800 Carronite	23.5631	523.00	627.60

PANELS

L shaped C/nite 1800x800x540	57.1021	276.00	331.20
Quantum panel 1800x540	23.3271	114.00	136.80
Concord panel 1800 x 540	23.1581	115.00	138.00
Quantum C/nite 1800x540	23.3321	150.00	180.00
Carronite panel 1800 x 540	23.1391	150.00	180.00
Universal end panel 800x540	23.1641	76.00	91.20
Carronite end panel 800x540	23.1451	96.00	115.20

Also available in the Arc Duo double-ended range: 1700 x 750 (P74)

FEATURES

- Bespoke whirlpool available
- No tap holes or waste fittings
- Carronite baths have a 30 year guarantee

ECHELON 1800

- Head Rest 



Both Echelon baths feature luxury chrome combined integral waterfall filler, (WRAS certified) overflow and flush fitting pop-up waste which is included in the price of the baths.



A spacious double ended bath available with our unique filler. Baths come with filler, waste and overflow. Separate control valves are required to use the filler.

1800 x 800 x 440mm		230 litres	
Description	Code	£ Ex VAT	£ Inc VAT
1800 x 800 5mm	23.4841	773.00	927.60
1800 x 800 Carronite	23.5841	1104.00	1324.80

PANELS

L shaped C/nite 1800x800x540*	57.1021	276.00	331.20
Quantum panel 1800x540	23.3271	114.00	136.80
Concord panel 1800 x 540	23.1581	115.00	138.00
Quantum C/nite 1800x540	23.3321	150.00	180.00
Carronite panel 1800 x 540	23.1391	150.00	180.00
Universal end panel 800x540	23.1641	76.00	91.20
Carronite end panel 800x540	23.1451	96.00	115.20

Also available in the Echelon range: 1700 x 750 (P73)

FEATURES

- Comes with filler and overflow
- Complete with push button waste
- No tap holes
- WRAS certified filler
- Carronite baths have a 30 year guarantee

ECHELON 1800 WITH TAP LEDGE

- Whirl Pool 
- Head Rest 



Both Echelon baths feature luxury chrome combined integral waterfall filler, (WRAS certified) overflow and flush fitting pop-up waste which is included in the price of the baths.



A spacious double ended bath available with our unique filler. Baths come with filler, tap ledge, waste and overflow. Separate control valves are required to use the filler.

1800 x 800 x 440mm		230 litres	
Description	Code	£ Ex VAT	£ Inc VAT
1800 x 800 C/nite with tap ledge	23.5881	1104.00	1324.80

PANELS

L shaped C/nite 1800x800x540	57.1021	276.00	331.20
Quantum panel 1800x540	23.3271	114.00	136.80
Concord panel 1800 x 540	23.1581	115.00	138.00
Quantum C/nite 1800x540	23.3321	150.00	180.00
Carronite panel 1800 x 540	23.1391	150.00	180.00
Universal end panel 800x540	23.1641	76.00	91.20
Carronite end panel 800x540	23.1451	96.00	115.20



Also available in the Echelon range: 1700 x 750 (P73)

FEATURES

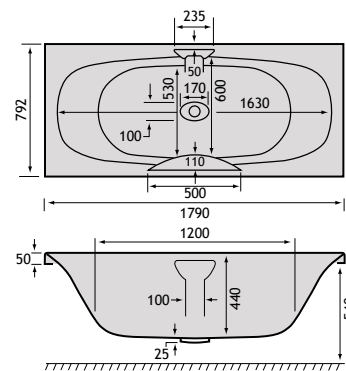
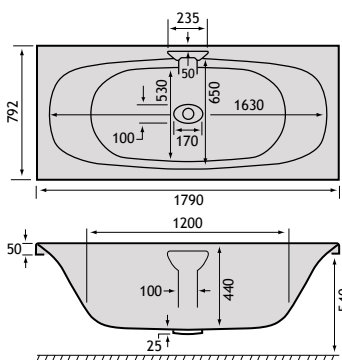
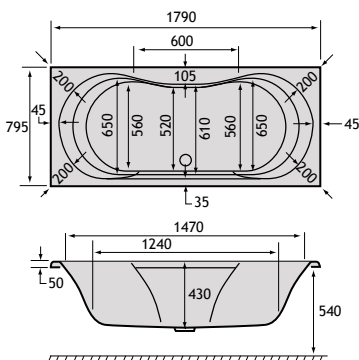
- Comes with filler and overflow
- Complete with push button waste
- No tap holes
- WRAS certified filler
- Carronite baths have a 30 year guarantee



BIARRITZ BRITANNIA

- Whirl Pool 
- Head Rest 



Clean lined simplicity makes the Biarritz Britannia the perfect complement to today's diverse range of bathroom furniture and accessories. Whether you prefer elegant understatement or bold, sweeping design, this classic bath will be right at home in your bathroom.

1800 x 800 x 430mm		245 litres	
Description	Code	£ Ex VAT	£ Inc VAT
1800 x 800 5mm	23.0011	483.00	579.60
1800 x 800 Carronite	23.2011	776.00	931.20

PANELS



L shaped C/nite 1800x800x540	57.1021	276.00	331.20
Quantum panel 1800x540	23.3271	114.00	136.80
Concord panel 1800 x 540	23.1581	115.00	138.00
Quantum C/nite 1800x540	23.3321	150.00	180.00
Carronite panel 1800 x 540	23.1391	150.00	180.00
Universal end panel 800x540	23.1641	76.00	91.20
Carronite end panel 800x540	23.1451	96.00	115.20

Also available in the Arc Duo double-ended range: 1700 x 750 (P74)

FEATURES

- No tap holes or waste fittings
- Carronite baths have a 30 year guarantee

EQUITY 1800

- Whirl Pool 
- Head Rest 



A spacious double ended bath in both 1700 and 1800mm with an integral tap ledge.

1800 x 800 x 440mm		225 litres	
Description	Code	£ Ex VAT	£ Inc VAT
1800 x 800 5mm	23.0025	573.00	687.60
1800 x 800 Carronite	23.2025	917.00	1100.40

PANELS

L shaped C/nite 1800x800x540	57.1021	276.00	331.20
Quantum panel 1800x540	23.3271	114.00	136.80
Concord panel 1800 x 540	23.1581	115.00	138.00
Quantum C/nite 1800x540	23.3321	150.00	180.00
Carronite panel 1800 x 540	23.1391	150.00	180.00
Universal end panel 800x540	23.1641	76.00	91.20
Carronite end panel 800x540	23.1451	96.00	115.20

Also available in the Equity range: 1700 x 750 (P76)

FEATURES

- Integral tap ledge
- Bespoke whirlpool available
- No tap holes or waste fittings
- Carronite baths have a 30 year guarantee

HAIKU 1800

- Whirl Pool 
- Head Rest 



An elegant minimalist bath with many straight lines and small radius curves and featuring a gentle sloping backrest.

1800 x 800 x 450mm		230 litres	
Description	Code	£ Ex VAT	£ Inc VAT
1800 x 800 5mm	23.4141	606.00	727.20
1800 x 800 Carronite	23.5141	999.00	1198.80
Headrest HR600	23.310	106.00	127.20

PANELS

L shaped C/nite 1800x800x540	57.1021	276.00	331.20
Quantum panel 1800x540	23.3271	114.00	136.80
Concord panel 1800 x 540	23.1581	115.00	138.00
Quantum C/nite 1800x540	23.3321	150.00	180.00
Carronite panel 1800 x 540	23.1391	150.00	180.00
Universal end panel 800x540	23.1641	76.00	91.20
Carronite end panel 800x540	23.1451	96.00	115.20

Also available in the Haiku range: 1700 x 800 (P81), 1800 x 900 (P94)

FEATURES

- Optional headrest available
- Bespoke whirlpool available
- No tap holes or waste fittings
- Carronite baths have a 30 year guarantee
- Can be fitted with an overflow filler 2.015

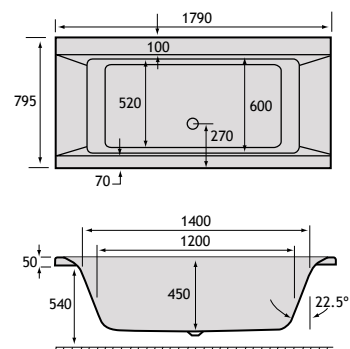
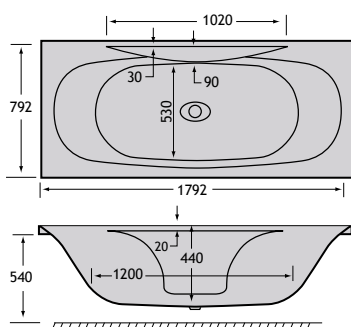
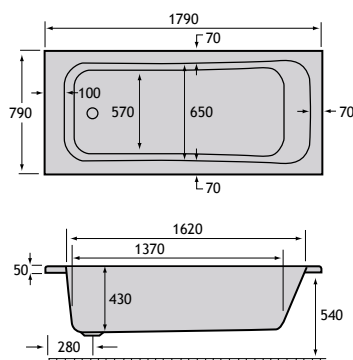

1800

QUANTUM SINGLE ENDED 1800



A new design single ended bath with straight sides and minimalist lines maximising both bath and showering space.

1800 x 800 x 440mm		285 litres	
Description	Code	£ Ex VAT	£ Inc VAT
1800 x 800 5mm	23.4681	341.00	409.20
1800 x 800 Carronite	23.5681	546.00	655.20
HR900 headrest	23.309	106.00	127.20

PANELS

L shaped C/nite 1800x800x540	57.1021	276.00	331.20
Quantum panel 1800x540	23.3271	114.00	136.80
Concord panel 1800 x 540	23.1581	115.00	138.00
Quantum C/nite 1800x540	23.3321	150.00	180.00
Carronite panel 1800 x 540	23.1391	150.00	180.00
Universal end panel 800x540	23.1641	76.00	91.20
Carronite end panel 800x540	23.1451	96.00	115.20

Also available in the Quantum range: 1500 (P51), 1600 x 700/800 (P55/57), 1700 x 700/750/800/900 (P66/78/82/84), 1800 x 725 (P86)

FEATURES

- Optional headrest available
- Suitable for showering
- Bespoke whirlpool available
- No tap holes or waste fittings

QUANTUM DUO 1800



A modern and minimalist version of a double ended bath. The straight sides and sloping backs give a spacious bathing area. It has a central waste and overflow below the tap ledge and is suitable for a bath screen.

1800 x 800 x 440mm		230 litres	
Description	Code	£ Ex VAT	£ Inc VAT
1800 x 800 5mm	23.4711	341.00	409.20
1800 x 800 Carronite	23.5711	546.00	655.20
HR900 headrest	23.309	106.00	127.20
Universal end panel 800x540	23.1641	76.00	91.20
Carronite end panel 800x540	23.1451	96.00	115.20

Also available in the Quantum range: 1700 x 700/750/800 (P66/78/82), 1900 x 900 (P95)

FEATURES

- Optional headrest available
- Suitable for showering
- Bespoke whirlpool available
- No tap holes or waste fittings
- Carronite baths have a 30 year guarantee

QUANTUM SINGLE ENDED INTEGRA



Combining the added safety and security that comes with a gripped bath, with the sleek, modern lines of the existing Quantums. The Integra features an integrated grip that has been designed to complement the original Quantum design.

1800 x 800 x 440mm		285 litres	
Description	Code	£ Ex VAT	£ Inc VAT
Integra SE 1800 x 800 TG 5mm	23.0029	368.00	441.60
Integra SE 1800 x 800 TG C/nite	23.2029	566.00	679.20
HR900 headrest	23.309	106.00	127.20

PANELS

L shaped C/nite 1800x800x540	57.1021	276.00	331.20
Quantum panel 1800x540	23.3271	114.00	136.80
Concord panel 1800 x 540	23.1581	115.00	138.00
Quantum C/nite 1800x540	23.3321	150.00	180.00
Carronite panel 1800 x 540	23.1391	150.00	180.00
Universal end panel 800x540	23.1641	76.00	91.20
Carronite end panel 800x540	23.1451	96.00	115.20

Also available in the Quantum SE Integra range: 1500 x 700 (P51), 1600 x 700 (P56), 1650 x 700 (59), 1700 x 700/750/800 (P68/79/81)

FEATURES

- Integral chrome twin grips
- Bespoke whirlpool available
- Suitable for showering
- No tap holes or waste fittings
- Carronite baths have a 30 year guarantee

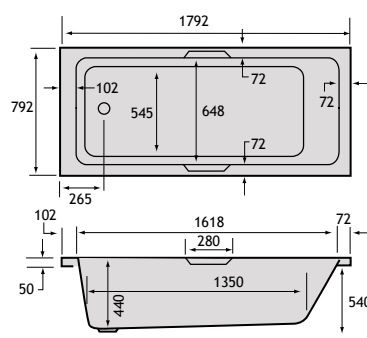
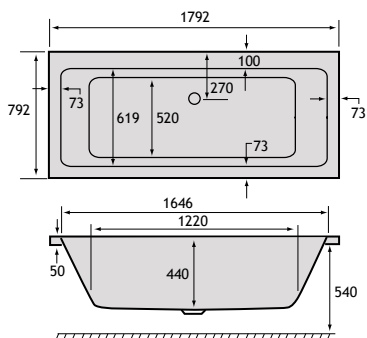
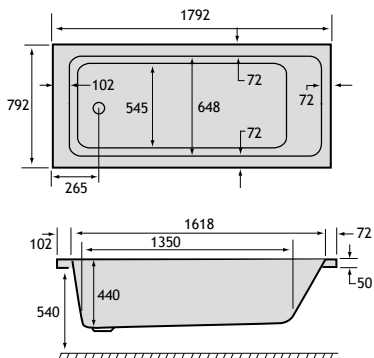

SIGMA 1800



This bath combines style and elegance with its smooth lines and larger bathing area to enjoy a relaxing soak.

1800 x 800 x 450mm	250 Litres		
Description	Code	£ Ex VAT	£ Inc VAT
1800 Plain 5mm	23.4041	514.00	616.80
1800 Plain Carronite	23.5041	954.00	1144.80
1800 x 800 TG 5mm	23.4271	555.00	666.00
1800 x 800 TG Carronite	23.5271	995.00	1194.00
Headrest HR800	23.312	106.00	127.20

PANELS

L shaped C/nite 1800x800x540	57.1021	276.00	331.20
Quantum panel 1800x540	23.3271	114.00	136.80
Concord panel 1800 x 540	23.1581	115.00	138.00
Quantum C/nite 1800x540	23.3321	150.00	180.00
Carronite panel 1800 x 540	23.1391	150.00	180.00
Universal end panel 800x540	23.1641	76.00	91.20
Carronite end panel 800x540	23.1451	96.00	115.20

Also available in the Sigma range:
1600 (P57), 1700 x 750 (P79),
1700 x 800 (P82), 1900 (P95)

FEATURES

- Available with chrome twin grips
- Stocked Carronite 6 jet c lenda whirlpool available, page 163
- Bespoke whirlpool available
- Optional headrest available
- Suitable for showering
- No tap holes or waste fittings
- Carronite baths have a 30 year guarantee

Head-rests available for all baths



Description	Code	£ Ex VAT	£ Inc VAT
Universal foam headrest	84.0001	28.00	33.60
Universal PU Gel Headrest	84.0000	55.00	66.00

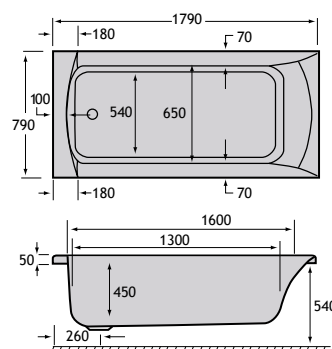

1800

ZONE 1800

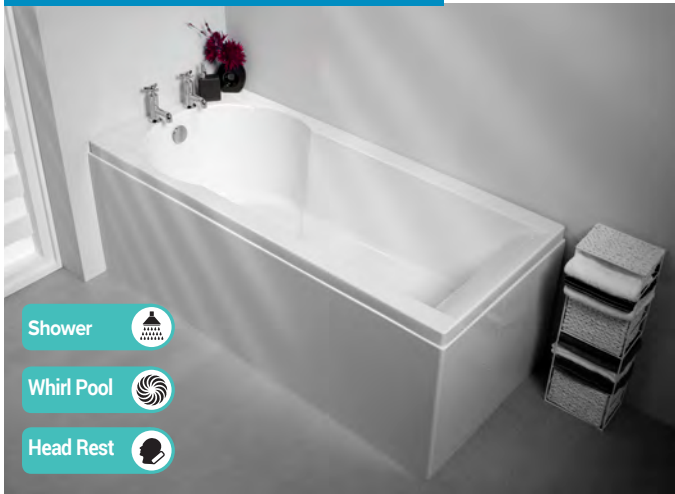

An innovative new idea in shower baths featuring a unique circular standing area making this bath ideal as a shower bath.

1800 x 800 x 430mm		275 Litres	
Description	Code	£ Ex VAT	£ Inc VAT
Showerbath 1800 x 800 5mm	23.4971	489.00	586.80
Showerbath 1800 x 800 C/nite	23.5971	774.00	928.80
Radius corner screen	69.702	155.00	186.00
Headrest HR700	23.311	106.00	127.20

PANELS

L shaped C/nite 1800x800x540	57.1021	276.00	331.20
Quantum panel 1800x540	23.3271	114.00	136.80
Concord panel 1800 x 540	23.1581	115.00	138.00
Quantum C/nite 1800x540	23.3321	150.00	180.00
Carronite panel 1800 x 540	23.1391	150.00	180.00
Universal end panel 800x540	23.1641	76.00	91.20
Carronite end panel 800x540	23.1451	96.00	115.20

Also available in the Zone range:
1700 x 750 (P80)

FEATURES

- Ideal for showering
- No tap holes or waste fittings
- Carronite baths have a 30 year guarantee

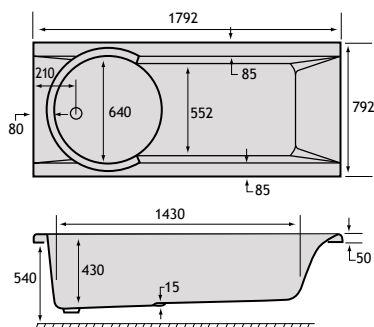

HAIKU 1800

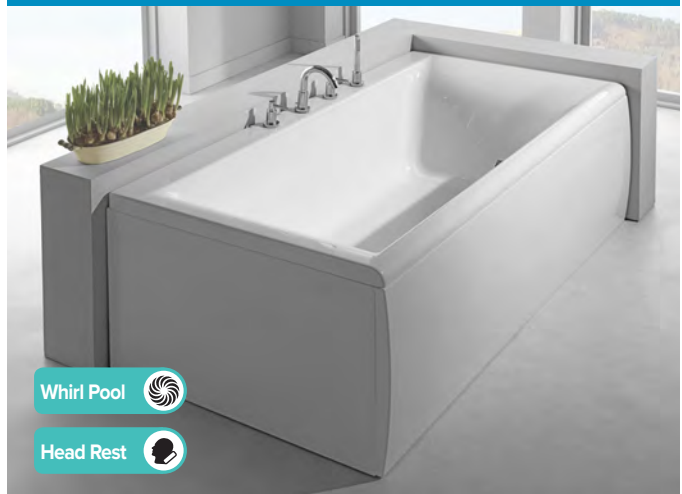

An elegant minimalist bath with many straight lines and small radius curves and featuring a gentle sloping backrest.

1800 x 900 x 450mm		290 Litres	
Description	Code	£ Ex VAT	£ Inc VAT
1800 x 900 5mm	23.4331	712.00	854.40
1800 x 900 Carronite	23.5331	1106.00	1327.20
Haiku 1800 x 900 5mm	23.310	106.00	127.20

PANELS

Quantum panel 1800x540	23.3271	114.00	136.80
Concord panel 1800 x 540	23.1581	115.00	138.00
Quantum C/nite 1800x540	23.3321	150.00	180.00
Carronite panel 1800 x 540	23.1391	150.00	180.00
Carronite panel 900 x 540	23.1461	109.00	130.80

Also available in the Haiku range:
1700 x 800 (P81), 1800 x 800 (P91)

FEATURES

- Bespoke whirlpool available
- No tap holes or waste fittings
- Carronite baths have a 30 year guarantee
- Optional headrest available
- Can be fitted with an overflow filler 2.015

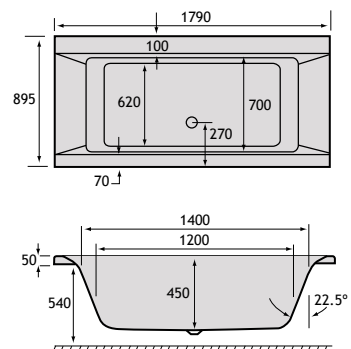

LINEA 1900

Whirl Pool 

Head Rest 



We asked the bath designer for a large, modern and beautiful bath; the designer excelled and the Linea was created.

1900 x 900 x 460		345 Litres	
Description	Code	£ Ex VAT	£ Inc VAT
1900 x 900 5mm	23.0691	780.00	936.00
1900 x 900 Carronite	23.2691	1258.00	1509.60
Linea 1900 x 900 5mm	23.310	106.00	127.20

PANELS

Front Panel 1900 x 570	23.1045	114.00	136.80
Front Panel C/nite 1900 x 570	23.1046	150.00	180.00
Universal end panel 900 x 570	23.1651	84.00	100.80
Carronite panel 900 x 570	23.1471	111.00	133.20

FEATURES

- Bespoke whirlpool available
- Optional headrest available
- No tap holes or waste fittings
- Carronite baths have a 30 year guarantee

QUANTUM DUO 1900

Shower 

Whirl Pool 

Head Rest 



A modern version of a double ended bath. The straight sides and sloping backs give a spacious bathing area. It has a central waste and overflow and is suitable for a bath screen.

1900 x 900 x 450mm		350 Litres	
Description	Code	£ Ex VAT	£ Inc VAT
Quantum Duo 1900 x 900 5mm	23.4931	536.00	643.20
Quantum Duo 1900 x 900 C/nite	23.5931	851.00	1021.20
HR900 headrest	23.309	106.00	127.20

PANELS

Front Panel 1900 x 570	23.1045	114.00	136.80
Front Panel C/nite 1900 x 570	23.1046	150.00	180.00
Universal end panel 900 x 570	23.1651	84.00	100.80
Carronite panel 900 x 570	23.1471	111.00	133.20

Also available in the Quantum Duo range:
1700 x 700/750/800 (P66/78/82),
1800 x 800 (P92)

FEATURES

- Central waste and overflow
- Suitable for a shower screen
- Bespoke whirlpool available
- No tap holes or waste fittings
- Carronite baths have a 30 year guarantee

SIGMA 1900

Shower 

Whirl Pool 

Grips 

Head Rest 



One of two huge baths representing the ultimate choice for maximum bathing area.

1700 x 750 x 440mm		195 Litres	
Description	Code	£ Ex VAT	£ Inc VAT
1900 x 900 Plain 5mm	23.4071	757.00	908.40
1900 x 900 Plain Carronite	23.5071	1221.00	1465.20
1900 x 900 TG 5mm	23.4281	798.00	957.60
1900 x 900 TG Carronite	23.5281	1262.00	1514.40
Headrest HR800	23.312	106.00	127.20

PANELS

Front Panel 1900 x 570	23.1045	114.00	136.80
Front Panel C/nite 1900 x 570	23.1046	150.00	180.00
Universal end panel 900 x 570	23.1651	84.00	100.80
Carronite panel 900 x 570	23.1471	111.00	133.20

Also available in the Sigma range:
1600 (P57), 1700 x 750 (P79),
1700 x 800 (P82), 1800 (P93)

FEATURES

- Available with chrome twin grips
- Bespoke whirlpool available
- Optional headrest available
- Suitable for showering
- No tap holes or waste fittings
- Carronite baths have a 30 year guarantee

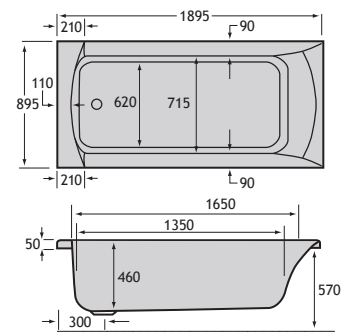
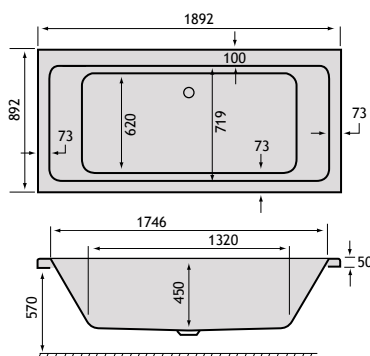
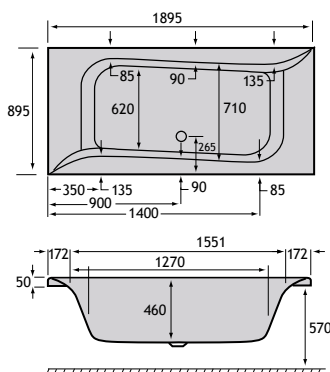

Showerbaths & Screens

SHOWER SCREEN OPTIONS

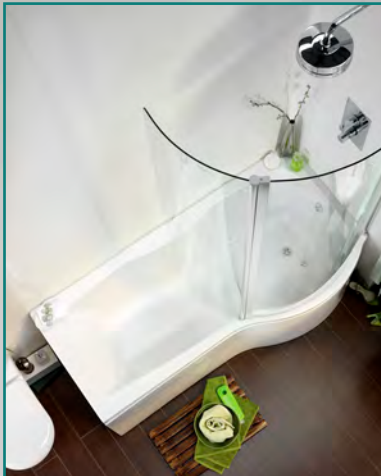

Type 2

One large curved hinge bath screen with an additional curved extension panel ensuring the most complete protection possible without being fully enclosed.



	Page no	Type 1	Type 2	Type 3	Standard screen with towel rail	Standard screen (6mm)	Standard screen (5mm)	Quantum screen	Quantum screen with towel rail	Sigma/Arc standard screen	Urban screen	Celsius showerbath screen
Quantum 1500	98	58.4001						58.4000	69.0141			
Profile 1500	99				69.0143	69.0140	69.0139				23.625	57.6000
Urban 1500	100											
Urban Edge 1575	102	58.4001						58.4000	69.0141			
Delta 1600	104		69.3002R/L		69.0143	69.0140	69.0139			58.713		
Quantum 1600	107	58.4001						58.4000	69.0141			
Brio 1650	103		69.3002R/L		69.0143	69.0140	69.0139					
Arc	118		69.2006R/L							23.620/58.713		
Quantum 1700	113	58.4001						58.4000	69.0141			
Axis	114		69.3002R/L		69.0143	69.0140	69.0139					
Delta 1700	116		69.3002R/L		69.0143	69.0140	69.0139					
Urban 1700	110											57.6000
Sigma 1800	120	69.2005R/69.2005L	69.2006R/L	69.2007						23.620/58.713		

Showerbaths & Screens

A VERSATILE RANGE OF SHOWER SCREENS ARE AVAILABLE FOR OFFSET BATHS TO MAKE YOUR BATHROOM MORE ADAPTABLE. TO FIND THE RELEVANT SCREEN FOR YOUR BATH SEE PAGES 96.

SHOWERBATH SCREEN WITH TOWEL RAIL



Based on the standard showerbath screen - a larger, single panel curved screen with an integral towel rail.

TYPE 1



A curved shower bath screen with additional flat hinged door allowing you to be fully enclosed when showering. Both panels have complete mobility and when not in use can be swung either side.

TYPE 3



A fixed quadrant bath screen with a sliding door which gives additional protection when showering.

STANDARD SHOWERBATH SCREEN



A curved bath screen which is specifically designed to fold away either side when not in use.

Showerbaths & Screens

QUANTUM 1500 SHOWERBATH

Shower 

Head Rest 



Quantum screen, no towel rail 58.4000

A modern and minimalist showerbath version of the Quantum bath. The straight sides and sloping back give a spacious bathing and showering area. The screen has a double hinge assembly with integral towel rail allowing easy access and cleaning.

1500 x 850 x 420mm		229 Litres	
Description	Code	£ Ex VAT	£ Inc VAT
Quantum 1500 RH 5mm	23.4891R	363.00	435.60
Quantum 1500 LH 5mm	23.4891L	363.00	435.60
Quantum 1500 RH Carronite	23.5891R	551.00	661.20
Quantum 1500 LH Carronite	23.5891L	551.00	661.20
Quantum screen 1400mm with towel rail*	69.0141	331.00	397.20
Quantum Screen no towel rail *	58.4000	245.00	294.00
Quantum Type 1 Screen*	58.4001	325.00	390.00
HR900 headrest	23.309	106.00	127.20

PANELS

Front panel 1500 x 540	23.3511	142.00	170.40
Quantum Carronite 1500 Showerbath Panel	23.3631	309.00	370.80
End panel 700 x 540	23.1041	89.00	106.80
Delta/Prado Showerbath C/nite end panel	23.1821	121.00	145.20

*Installation tolerance allows for wall covering up to 12mm. This bath has a suspended panel.

RECOMMENDED WASTE

Luxury Bath Pop Up Waste & Overflow	41.2008	32.00	38.40
-------------------------------------	---------	-------	--------------

FEATURES

- Optional headrest available
- Ideal for showering
- No tap holes or waste fittings
- Carronite baths have a 30 year guarantee

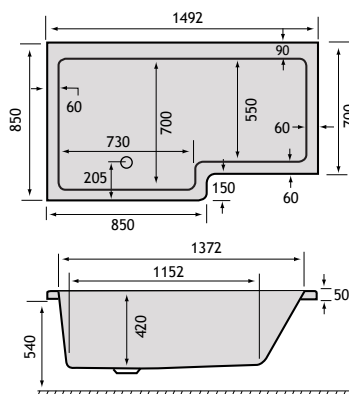

LEFT HAND SHOWN

Showerbaths & Screens

PROFILE 1500 SHOWERBATH

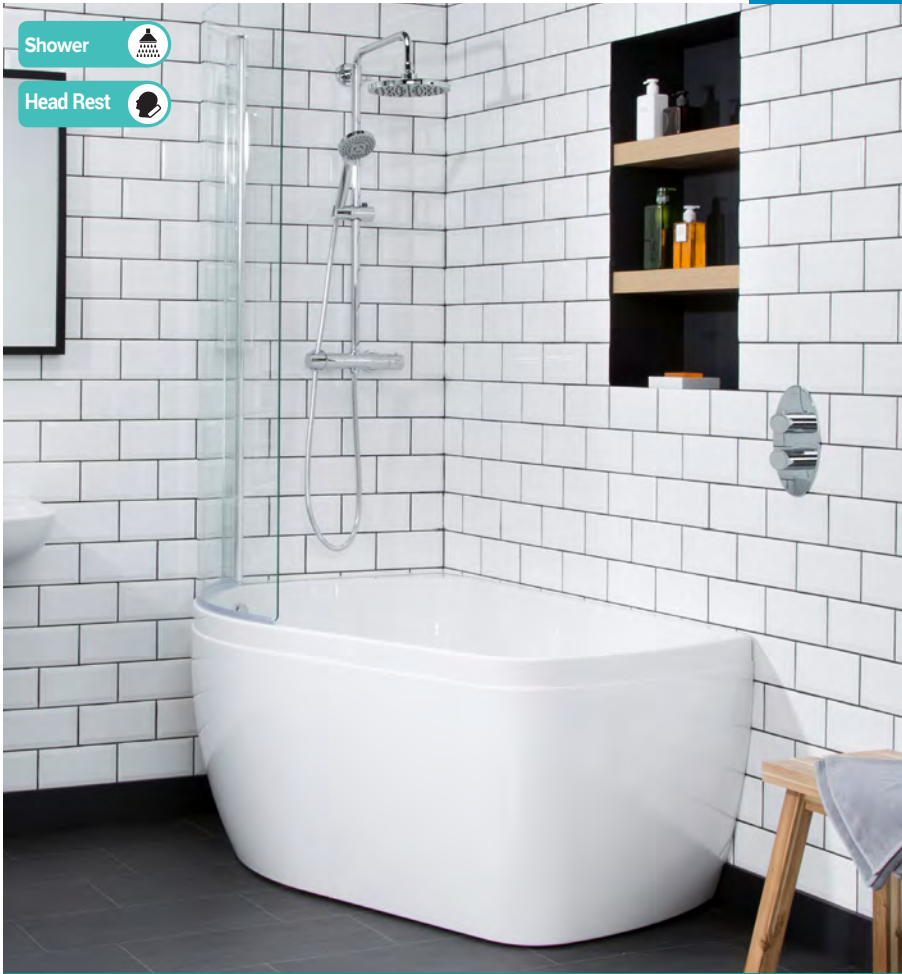

- Shower 
- Head Rest 

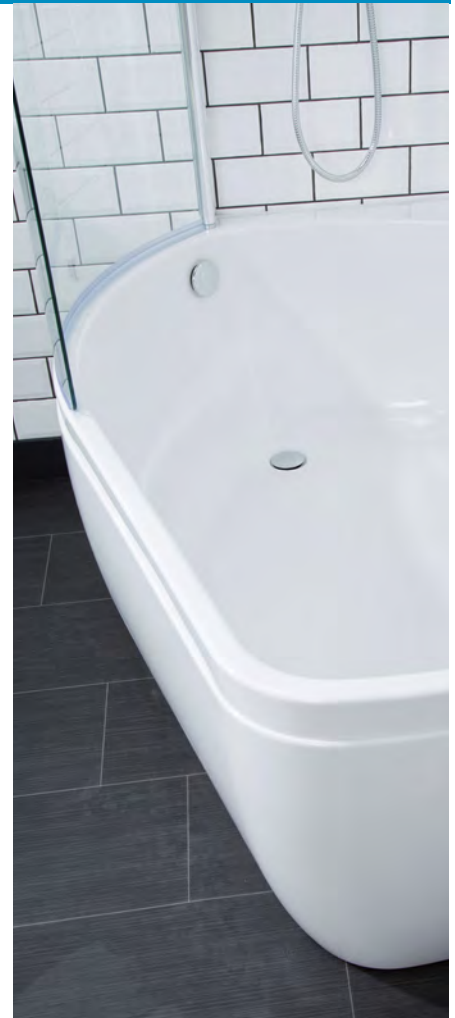

Shown with 69.0140 bath screen, left hand bath shown.

An unusual and unique designed bath to give a contemporary look to any bathroom. A 1500 bath with a 900 width to cleverly maximise space for showering.

1500 x 900 x 440mm		241 Litres	
Description	Code	£ Ex VAT	£ Inc VAT
Profile 1500 RH 5mm	23.0059	540.00	648.00
Profile 1500 LH 5mm	23.0058	540.00	648.00
Profile 1500 RH Carronite	23.2059	849.00	1018.80
Profile 1500 LH Carronite	23.2058	849.00	1018.80

PANELS

1500 front panel RH	23.1027	205.00	246.00
1500 front panel LH	23.1026	205.00	246.00

SHOWERSCREENS

Urban Shower Screen 1500mm height	23.625	202.00	242.40
C Shape Shower Screen 6mm easy clean 1500mm height	69.0140	167.00	200.40
C shape screen with towel rail 1400mm height	69.0143	303.00	363.60
C Shape Shower Screen 5mm 1500mm height	69.0139	112.00	134.40

FEATURES

- Optional headrest available
- Ideal for showering
- No tap holes or waste fittings
- Carronite baths have a 30 year guarantee

Head-rests available for all baths



Description	Code	£ Ex VAT	£ Inc VAT
Universal foam headrest	84.0001	28.00	33.60
Universal PU Gel Headrest	84.0000	55.00	66.00

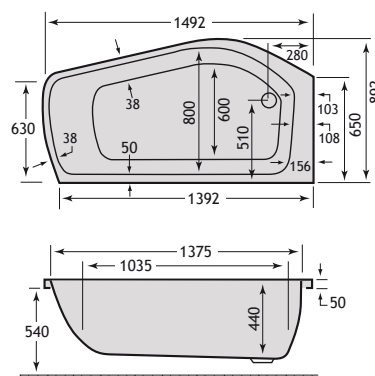

RIGHT HAND SHOWN

Showerbaths & Screens

URBAN 1500 SHOWERBATH



Shower

Whirl Pool

Head Rest

Urban showerbath screen. Code: 23.625

LEFT HAND SHOWN

A modern angular showerbath with extra width for comfortable showering. Also available in 1700, and a straight rectangular 1700 bath. (See page 69)

1500 x 900 x 420mm		228 Litres	
Description	Code	£ Ex VAT	£ Inc VAT
Urban 1500 LH 5mm	23.0018L	523.00	627.60
Urban 1500 RH 5mm	23.0018R	523.00	627.60
Urban 1500 LH Carronite	23.2018L	871.00	1045.20
Urban 1500 RH Carronite	23.2018R	871.00	1045.20
Urban Shower Screen 1400mm height *	23.625	202.00	242.40

PANELS

L shaped 1500 Carronite panel	23.1047	410.00	492.00
1500 front panel 5mm	23.3001	187.00	224.40
1500 front panel Carronite	23.3002	300.00	360.00
Urban end panel 5mm	23.1251	89.00	106.80
Urban end panel Carronite	23.1791	121.00	145.20

*No other screens are compatible. This bath has a suspended panel.

FEATURES

- Bespoke whirlpool available
- Ideal for showering
- No tap holes or waste fittings
- Carronite baths have a 30 year guarantee
- Optional headrest available
- Can be fitted with an overflow filler 2.015

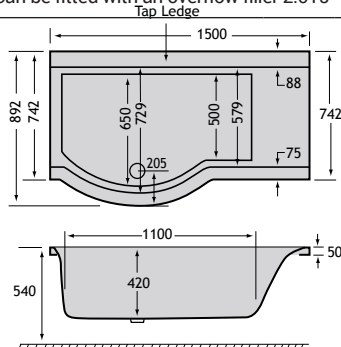

Head-rests available for all baths



Description	Code	£ Ex VAT	£ Inc VAT
Universal foam headrest	84.0001	28.00	33.60
Universal PU Gel Headrest	84.0000	55.00	66.00

Showerbaths & Screens

STATUS 1500 SHOWERBATH



- Shower 
- Whirl Pool 
- Head Rest 

LEFT HAND SHOWN

Left hand shown with 58.4000 screen

Bringing a unique perspective to bathroom design, the Status adds a touch of luxury with its soft curves and ideal proportions - now available as shower bath option as shown above.

1550 x 850 x 450mm		262 Litres	
Description	Code	£ Ex VAT	£ Inc VAT
Status Showerbath 5mm LH	23.0035L	502.00	602.40
Status Showerbath 5mm RH	23.0035R	502.00	602.40
Status Showerbath Carronite LH	23.2035L	834.00	1000.80
Status Showerbath Carronite RH	23.2035R	834.00	1000.80

PANELS			
Description	Code	£ Ex VAT	£ Inc VAT
Status Showerbath Panel 5mm	23.1004	201.00	241.20
Status Showerbath Panel Carronite	23.1005	288.00	345.60

This bath has a suspended panel.

SCREENS			
Description	Code	£ Ex VAT	£ Inc VAT
Quantum screen	58.4000	245.00	294.00
Quantum screen 1400mm with towel rail	69.0141	331.00	397.20

- FEATURES**
- Ideal for showering
 - No tap holes or waste fittings
 - Carronite baths have a 30 year guarantee
 - Bespoke whirlpool available

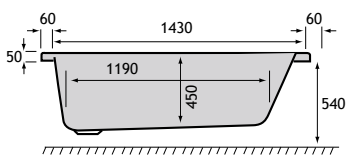
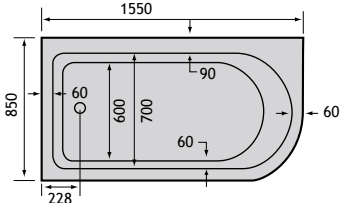

Showerbaths & Screens

URBAN EDGE 1575 SHOWERBATH



Shower 

Whirl Pool 

Head Rest 



Also available with ledge, see Swing bath page 52

An addition to the Urban family, the angular design on the urban edge provides a greater space for luxurious bathing and showering

1575 x 845 x 420mm	225 Litres		
Description	Code	£ Ex VAT	£ Inc VAT
Urban Edge Showerbath LH 1575x845	23.0046L	508.00	609.60
Urban Edge Showerbath RH 1575x845	23.0046R	508.00	609.60
Urban Edge Showerbath LH 1575x845	23.2046L	849.00	1018.80
Urban Edge Showerbath RH 1575x845	23.2046R	849.00	1018.80

PANELS			
L Shaped Panel 1580x700x540 Carronite	23.1019	415.00	498.00
Urban Edge Front Panel 5mm	23.1009	187.00	224.40
Urban Edge Front Panel Carronite	23.1010	300.00	360.00

SHOWER SCREENS			
Quantum Screen 1400	58.4000	245.00	294.00
Quantum screen 1400mm with towel rail	69.0141	331.00	397.20
Quantum Type 1 Screen 1400	58.4001	325.00	390.00

ACCESSORIES			
Shallow Profile Bath Filler	2.015	204.00	244.80

*Taps must be mounted left or right of screen wall profile.

- FEATURES**
- Bespoke whirlpool available
 - Ideal for showering
 - No tap holes or waste fittings
 - Carronite baths have a 30 year guarantee
 - Optional headrest available
 - Can be fitted with an overflow filler 2.015

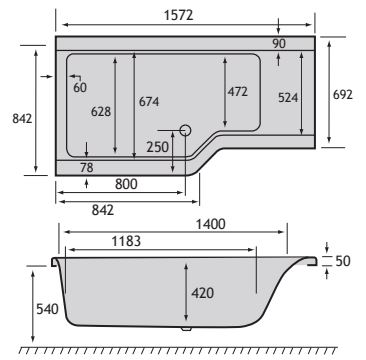

Showerbaths & Screens

BRIO SHOWERBATH 1650 (5'5")



An alternative sized showerbath at 1650mm to help fit where space is at a premium, with extra showering space and a modern side mounted tap ledge.

1650 x 845 x 420mm		254 Litres	
Description	Code	£ Ex VAT	£ Inc VAT
1650 x 845 RH 5mm	23.4791R	504.00	604.80
1650 x 845 LH 5mm	23.4791L	504.00	604.80
1650 x 845 RH Carronite	23.5791R	840.00	1008.00
1650 x 845 LH Carronite	23.5791L	840.00	1008.00

PANELS

Front panel 1650 x 540 5mm	23.3441	123.00	147.60
Front panel 1650 x 540 C/nite	23.3451	240.00	288.00
End panel 700 x 540 5mm	23.1041	89.00	106.80
End panel 700 x 540 Carronite	23.1821	121.00	145.20

SHOWER SCREENS

Description	PR*	Height	Code	£ Ex VAT	£ Inc VAT
Revised Delta screen type 2-1 folding door RH	2	1535mm	69.3002R	459.00	550.80
Revised Delta screen type 2-1 folding door LH	2	1535mm	69.3002L	459.00	550.80
C Shape Shower Screen 6mm easy clean (Chrome)	4	1500mm	69.0140	167.00	200.40
C shape screen with towel rail	-	1400mm	69.0143	303.00	363.60
C Shape Shower Screen 5mm 1500mm height	-	1500mm	69.0139	112.00	134.40

FEATURES

- Ideal for showering
- No tap holes or waste fittings
- Carronite baths have a 30 year guarantee
- Bespoke whirlpool available
- Optional headrest available
- Can be fitted with an overflow filler 2.015

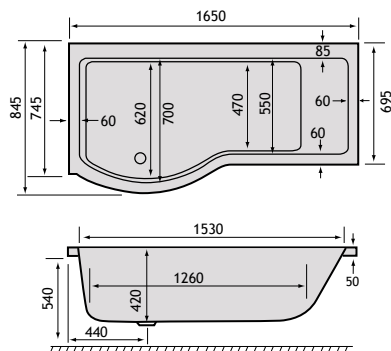

Showerbaths & Screens

DELTA 1600 SHOWERBATH

Shower 

Whirl Pool 

Head Rest 



Available with chrome on brass towel rail 69.0143

The Delta shower bath offers the opportunity to shower or bathe in comfort and style in an elegant combination which requires little more space than a standard bath. This really is space saving luxury.

1600 x 800 x 410mm **210 Litres**

Description	Code	£ Ex VAT	£ Inc VAT
Delta 1600 RH 5mm	23.0681R	475.00	570.00
Delta 1600 LH 5mm	23.0681L	475.00	570.00
Delta 1600 RH Carronite	23.2681R	789.00	946.80
Delta 1600 LH Carronite	23.2681L	789.00	946.80
Headrest HR800	23.312	106.00	127.20

PANELS

1600 front panel	23.1901	136.00	163.20
1600 front panel Carronite	23.3391	278.00	333.60
End panel	23.1041	89.00	106.80
End panel Carronite	23.1821	121.00	145.20

This bath has a suspended panel.

FEATURES

- Optional headrest available
- Ideal for showering
- No tap holes or waste fittings
- Carronite baths have a 30 year guarantee

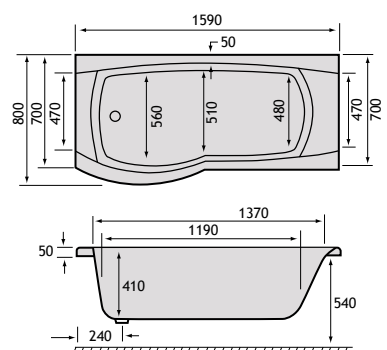

Right hand bath shown with 69.0140 screen.

Showerbaths & Screens

DELTA SHOWER SCREENS



Shower 

Whirl Pool 

Head Rest 

Right hand bath shown with 69.3002R screen.

Delta Shower Screens

Description	PR*	Height	Code	£ Ex VAT	£ Inc VAT
Revised Delta screen type 2-1 folding door RH	2	1535mm	69.3002R	459.00	550.80
Revised Delta screen type 2-1 folding door LH	2	1535mm	69.3002L	459.00	550.80
Arc Showerscreen 6mm Easyclean	-	1400mm	58.713	165.00	198.00
C Shape Shower Screen 6mm easy clean (Chrome)	4	1500mm	69.0140	167.00	200.40
C shape screen with towel rail	5	1400mm	69.0143	303.00	363.60
C Shape Shower Screen 5mm 1500mm height	-	1500mm	69.0139	112.00	134.40

PR* picture reference.

FEATURES

- Optional headrest available
- Ideal for showering
- No tap holes or waste fittings
- Carronite baths have a 30 year guarantee

Head-rests available for all baths



Description	Code	£ Ex VAT	£ Inc VAT
Universal foam headrest	84.0001	28.00	33.60
Universal PU Gel Headrest	84.0000	55.00	66.00

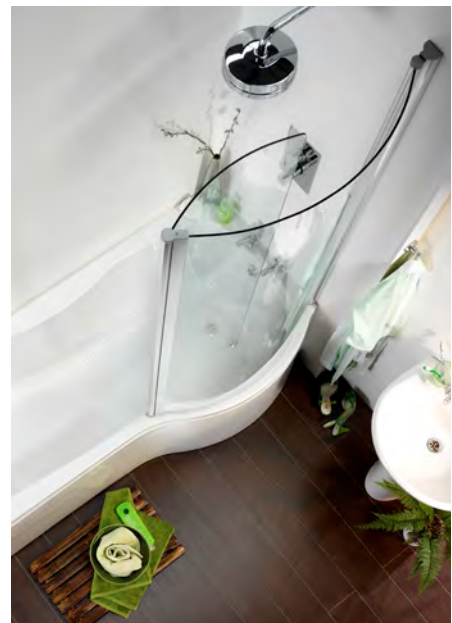

Showerbaths & Screens

QUANTUM 1600 SHOWERBATH

Shower 

Head Rest 



Head-rests available for all baths



Description	Code	£ Ex VAT	£ Inc VAT
Universal foam headrest	84.0001	28.00	33.60
Universal PU Gel Headrest	84.0000	55.00	66.00

We recommend an overflow with a projection of no more than 45mm on this bath. Screen shown is 69.0141

Showerbaths & Screens

QUANTUM 1600 SHOWERBATH

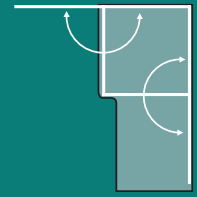

Quantum Type 1 screen 58.4001 - for this screen taps must be mounted left or right of screen profile.

1600 x 700mm 225 Litres

Description	Code	£ Ex VAT	£ Inc VAT
Quantum 1600x700 plain LH 5mm	23.0026L	363.00	435.60
Quantum 1600x700 plain RH 5mm	23.0026R	363.00	435.60
Quantum 1600x700 plain LH Carronite	23.2026L	551.00	661.20
Quantum 1600x700 plain RH Carronite	23.2026R	551.00	661.20
Quantum screen 1400mm with towel rail	69.0141	331.00	397.20
Quantum Screen no towel rail 1400mm	58.4000	245.00	294.00
Quantum Type 1 Screen 1400mm	58.4001	325.00	390.00
HR900 headrest	23.309	106.00	127.20

PANELS

Quantum 1600 panel	23.1971	142.00	170.40
Quantum 1600 Carronite panel	23.1981	309.00	370.80
End panel 700 x 540	23.1041	89.00	106.80
Delta/Prado Showerbath C/nite end panel	23.1821	121.00	145.20

*Installation tolerance allows for wall covering up to 12mm.
This bath has a suspended panel.

RECOMMENDED WASTE

Luxury Bath Pop Up Waste & Overflow	41.2008	32.00	38.40
-------------------------------------	---------	-------	--------------

ACCESSORIES

Shallow Profile Bath Filler	2.015	204.00	244.80
-----------------------------	-------	--------	---------------

FEATURES

- Optional headrest available
- Ideal for showering
- No tap holes or waste fittings
- Carronite baths have a 30 year guarantee
- Can be fitted with an overflow filler 2.015

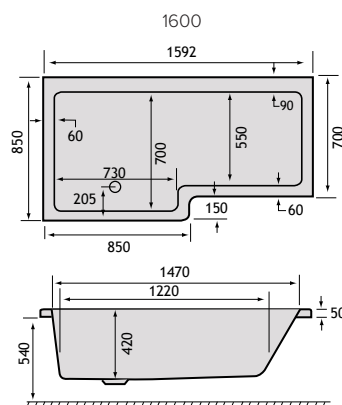

Showerbaths & Screens

URBAN EDGE 1675



Whirl Pool 

Head Rest 

An addition to the Urban family, the angular design on the urban edge provides a greater space for luxurious bathing and showering.

1675 x 850 x 420mm		245 Litres	
Description	Code	£ Ex VAT	£ Inc VAT
Urban Edge 1675 LH 5mm	23.0066L	508.00	609.60
Urban Edge 1675 RH 5mm	23.0066R	508.00	609.60
Urban Edge 1675 LH Carronite	23.2066L	849.00	1018.80
Urban Edge 1675 RH Urban Edge 1675 RH Carronite	23.2066R	849.00	1018.80

PANELS

L Shaped Panel 1675x700x540 C/nite	23.1051	415.00	498.00
Urban Edge 1675 Front Panel 5mm	23.1049	187.00	224.40
Urban Edge 1675 Front Panel C/nite	23.1050	300.00	360.00

SHOWER SCREENS

Quantum Screen 1400mm	58.4000	245.00	294.00
Quantum screen 1400mm with towel rail	69.0141	331.00	397.20
Quantum Type 1 Screen 1400mm	58.4001	325.00	390.00

*Taps must be mounted left or right of screen wall profile.

FEATURES

- Ideal for showering
- No tap holes or waste fittings
- Carronite baths have a 30 year guarantee
- Optional headrest available
- Can be fitted with an overflow filler 2.015

Head-rests available for all baths



Description	Code	£ Ex VAT	£ Inc VAT
Universal foam headrest	84.0001	28.00	33.60
Universal PU Gel Headrest	84.0000	55.00	66.00

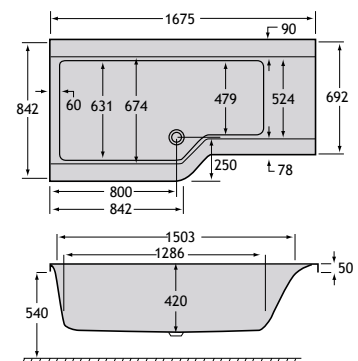

Showerbaths & Screens

HIGHGATE 1700 SHOWERBATH



Left hand bath shown. Screen for illustration purposes only.

A showerbath version of the art deco inspired bath that combines style with functionality.

1700 x 900 x 540mm		272 Litres	
Description	Code	£ Ex VAT	£ Inc VAT
Highgate Showerbath LH C/nite	23.6009	1029.00	1234.80
Highgate Showerbath RH C/nite	23.6010	1029.00	1234.80

PANELS

Highgate Showerbath L-Panel	23.6012	416.00	499.20
Highgate Showerbath Screen LH*	23.6019	260.00	312.00
Highgate Showerbath Screen RH*	23.6026	260.00	312.00

*Taps must be mounted left or right of screen wall profile.

FEATURES

- Ideal for showering
- No tap holes
- Carronite baths have a 30 year guarantee
- Optional headrest available
- Waste and overflow fittings supplied

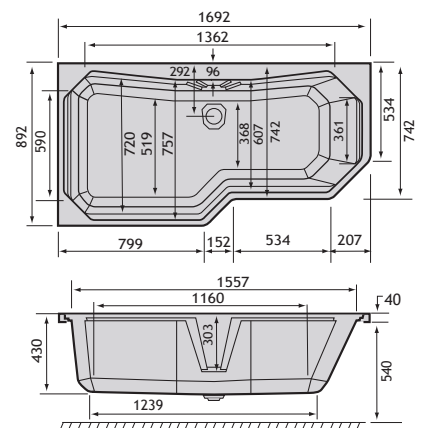

Showerbaths & Screens

URBAN 1700 SHOWERBATH

Shower 

Whirl Pool 

Head Rest 



Fitted with Urban showerbath screen, Code: 23.625 left hand bath shown

Showerbaths & Screens

URBAN 1700 SHOWERBATH



Celsius showerbath screen. Code: 57.6000 shown on Celsius showerbath.

A modern angular showerbath with extra width for comfortable showering. Also available in 1500, and a straight rectangular 1700 bath. (See page 69)

1700 x 900 x 420mm		260 Litres	
Description	Code	£ Ex VAT	£ Inc VAT
Urban 1700 LH 5mm	23.0019L	523.00	627.60
Urban 1700 RH 5mm	23.0019R	523.00	627.60
Urban 1700 LH Carronite	23.2019L	871.00	1045.20
Urban 1700 RH Carronite	23.2019R	871.00	1045.20
Urban Shower Screen 1500mm height	23.625	202.00	242.40
Celsius showerbath screen 1450mm height	57.6000	619.00	742.80

PANELS

L shaped 1700 Carronite panel	23.1048	410.00	492.00
Urban Showerbath 1700 front panel 5mm	23.3004	187.00	224.40
Urban Showerbath 1700 front panel cnite	23.3005	300.00	360.00
Urban Showerbath End panel 5mm	23.1251	89.00	106.80
Urban Showerbath Carronite end panel	23.1791	121.00	145.20

This bath has a suspended panel.

Head-rests available for all baths



Description	Code	£ Ex VAT	£ Inc VAT
Universal foam headrest	84.0001	28.00	33.60
Universal PU Gel Headrest	84.0000	55.00	66.00

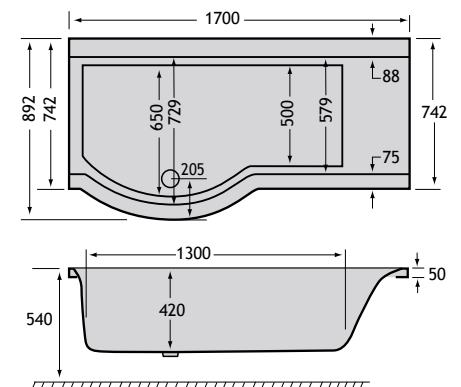

Showerbaths & Screens

QUANTUM 1700 SHOWERBATH



Quantum screen, no towel rail
58.4000

Shower 

Head Rest 

Quantum Diamante. MDF vinyl-wrapped panel shown. Also available in high gloss white. Shower screen shown 69.0141

Modern and minimalist showerbath version of the Quantum bath. The straight sides and sloping back give a spacious bathing and showering area. The screen has a double hinge assembly with integral towel rail allowing easy access and cleaning.

1700 x 700 x 410mm		265 Litres	
Description	Code	£ Ex VAT	£ Inc VAT
Quantum 1700 x 700 RH 5mm	23.4511R	363.00	435.60
Quantum 1700 x 700 LH 5mm	23.4511L	363.00	435.60
Quantum 1700 x 700 RH Carronite	23.5511R	551.00	661.20
Quantum 1700 x 700 LH Carronite	23.5511L	551.00	661.20
Quantum screen 1400mm with towel rail*	69.0141	331.00	397.20
Quantum Screen no towel rail 1400mm*	58.4000	245.00	294.00
Quantum Type 1 Screen 1400mm*	58.4001	325.00	390.00
HR900 headrest	23.309	106.00	127.20

PANELS			
Description	Code	£ Ex VAT	£ Inc VAT
Front panel 5mm 1700 x 540	23.3161	142.00	170.40
Quantum Carronite 1700 Showerbath Panel	23.3621	300.00	360.00
End panel 5mm 700 x 540	23.1041	89.00	106.80
Delta/Prado Showerbath Carronite end panel	23.1821	121.00	145.20

*Installation tolerance allows for wall covering up to 12mm. This bath has a suspended panel. We recommend an overflow with a projection of no more than 45mm on this bath.

QUANTUM MDF PANELS			
Description	Code	£ Ex VAT	£ Inc VAT
Quantum Diamante front panel LH Dark Walnut	34.01805L	203.00	243.60
Quantum Diamante front panel RH Dark Walnut	34.01805R	203.00	243.60
Quantum Diamante end panel Dark Walnut	34.02105	62.00	74.40
Quantum Diamante front panel LH HG White	34.0188L	205.00	246.00
Quantum Diamante front panel RH HG White	34.0188R	205.00	246.00
Quantum Diamante end panel HG White	34.0218	66.00	79.20

RECOMMENDED WASTE			
Description	Code	£ Ex VAT	£ Inc VAT
Luxury Bath Pop Up Waste & Overflow	41.2008	32.00	38.40

- FEATURES**
- Ideal for showering
 - Optional headrest available
 - No tap holes or waste fittings
 - Carronite baths have a 30 year guarantee
 - Can be fitted with an overflow filler 2.015



Head-rests available for all baths			
Description	Code	£ Ex VAT	£ Inc VAT
Universal foam headrest	84.0001	28.00	33.60
Universal PU Gel Headrest	84.0000	55.00	66.00

Showerbaths & Screens

QUANTUM 1700 SHOWERBATH



Quantum Type 1 screen 58.4001 - for this screen taps must be mounted left or right of screen wall profile

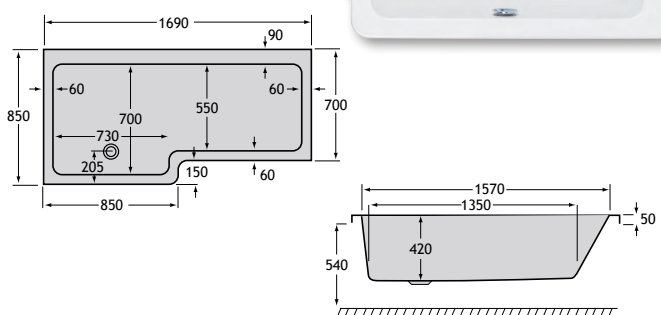

Quantum screen, with towel rail 69.0141

Showerbaths & Screens

AXIS 1700 SHOWERBATH

Shower 

Eco 

Low Level 

Head Rest 



C shape screen, with towel rail 69.0143.

C shape screen, no towel rail 69.0140.

The Axis shower bath is low level and offers easy access with the added advantage of using less water.

1700 x 800 x 345mm	190 Litres		
Description	Code	£ Ex VAT	£ Inc VAT
Axis 1700 offset 5mm RH	23.4411R	489.00	586.80
Axis 1700 offset 5mm LH	23.4411L	489.00	586.80
Axis 1700 offset Carronite RH	23.5411R	813.00	975.60
Axis 1700 offset Carronite LH	23.5411L	813.00	975.60
Headrest HR800	23.312	106.00	127.20

PANELS			
Description	Code	£ Ex VAT	£ Inc VAT
1700 offset front panel	23.1761	136.00	163.20
1700 offset front panel C/nite	23.1781	278.00	333.60
700 end panel	23.1771	76.00	91.20
700 end panel Carronite	23.1811	100.00	120.00

This bath has a suspended panel.

AXIS SHOWER SCREENS

Description	PR	Height	Code	£ Ex VAT	£ Inc VAT
C Shape Shower Screen 6mm easy clean (Chrome)	2	1500mm	69.0140	167.00	200.40
C shape screen with towel rail	3	1400mm	69.0143	303.00	363.60
Delta screen type 2-1 folding door RH	1	1535mm	69.3002R	459.00	550.80
Delta screen type 2-1 folding door LH*	1	1535mm	69.3002L	459.00	550.80
C Shape Shower Screen 5mm	-	1500mm	69.0139	112.00	134.40

PR: picture reference.

FEATURES

- Ideal for showering
- Low level gives easy access
- Optional headrest available

- No tap holes or waste fittings
- Carronite baths have a 30 year guarantee
- Bespoke whirlpool available

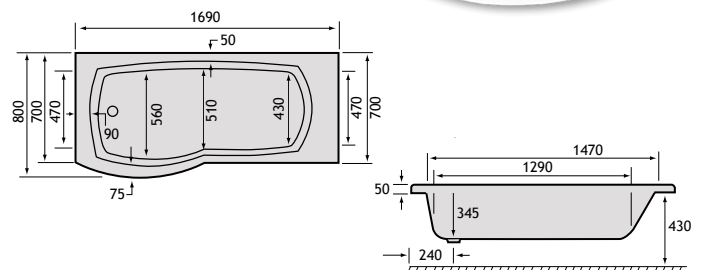

Showerbaths & Screens

AXIS 1700 SHOWERBATH



1535mm wide

Head-rests available for all baths



Description	Code	£ Ex VAT	£ Inc VAT
Universal foam headrest	84.0001	28.00	33.60
Universal PU Gel Headrest	84.0000	55.00	66.00

1

Type 2 screen 1 folding door right hand 69.3002R.

Showerbaths & Screens

DELTA 1700 SHOWERBATH

Shower 

Whirl Pool 

Head Rest 

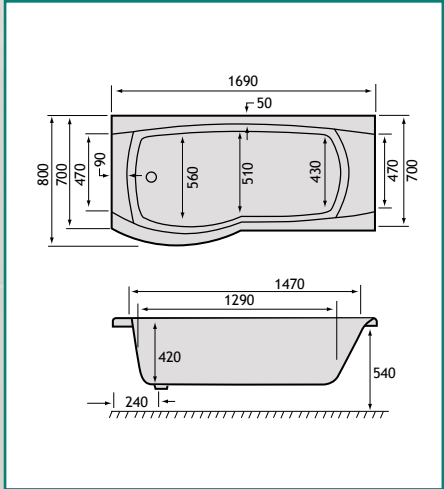

Head-rests available for all baths



Description	Code	£ Ex VAT	£ Inc VAT
Universal foam headrest	84.0001	28.00	33.60
Universal PU Gel Headrest	84.0000	55.00	66.00

1

Type 2, 1 folding door screen 69.3002R.

Showerbaths & Screens



'C' shape screen 69.0140



'C' shape screen with towel rail 69.0143

The Delta shower bath offers the opportunity to shower or bathe in comfort and style in an elegant combination which requires little more space than a standard bath. This really is space saving luxury.

1700 x 800 x 420mm **230 Litres**

Description	Code	£ Ex VAT	£ Inc VAT
-------------	------	----------	-----------

DELTA 1700 - WITHOUT WHIRLPOOL

Delta 1700 5mm RH	23.0671R	475.00	570.00
Delta 1700 5mm LH	23.0671L	475.00	570.00
Delta 1700 Carronite RH	23.2671R	789.00	946.80
Delta 1700 Carronite LH	23.2671L	789.00	946.80
Headrest HR800	23.312	106.00	127.20

DELTA 1700 - WITH WHIRLPOOL

1700 LH C/nite c-lenda w/p sys1	19.144L	1521.00	1825.20
1700 RH C/nite c-lenda w/p sys1	19.144R	1521.00	1825.20

PANELS

1700 front panel	23.1911	136.00	163.20
1700 front panel Carronite	23.1701	278.00	333.60
End panel	23.1041	89.00	106.80
End panel Carronite	23.1821	121.00	145.20

This bath has a suspended panel.

DELTA SHOWER SCREENS

Description	PR	Height	Code	£ Ex VAT	£ Inc VAT
Delta screen type 2-1 folding door RH	1	1535mm	69.3002R	459.00	550.80
Delta screen type 2-1 folding door LH	1	1535mm	69.3002L	459.00	550.80
C Shape Shower Screen 6mm easy clean (Chrome)	2	1500mm	69.0140	167.00	200.40
C shape screen with towel rail	3	1400mm	69.0143	303.00	363.60
C Shape Shower Screen 5mm	3	1500mm	69.0139	112.00	134.40

PR: picture reference.

FEATURES

- Bespoke whirlpool available
- Ideal for showering
- No tap holes or waste fittings
- Carronite baths have a 30 year guarantee
- Optional headrest available
- Other whirlpools available with this model. See page 164-165.



Showerbaths & Screens

ARC 1700 SHOWERBATH

Shower 

Whirl Pool 

Head Rest 



Head-rests available for all baths



Description	Code	£ Ex VAT	£ Inc VAT
Universal foam headrest	84.0001	28.00	33.60
Universal PU Gel Headrest	84.0000	55.00	66.00

1

Left hand bath, with Carronite panel shown and Arc shower screen 23.620

Showerbaths & Screens

ARC 1700 SHOWERBATH

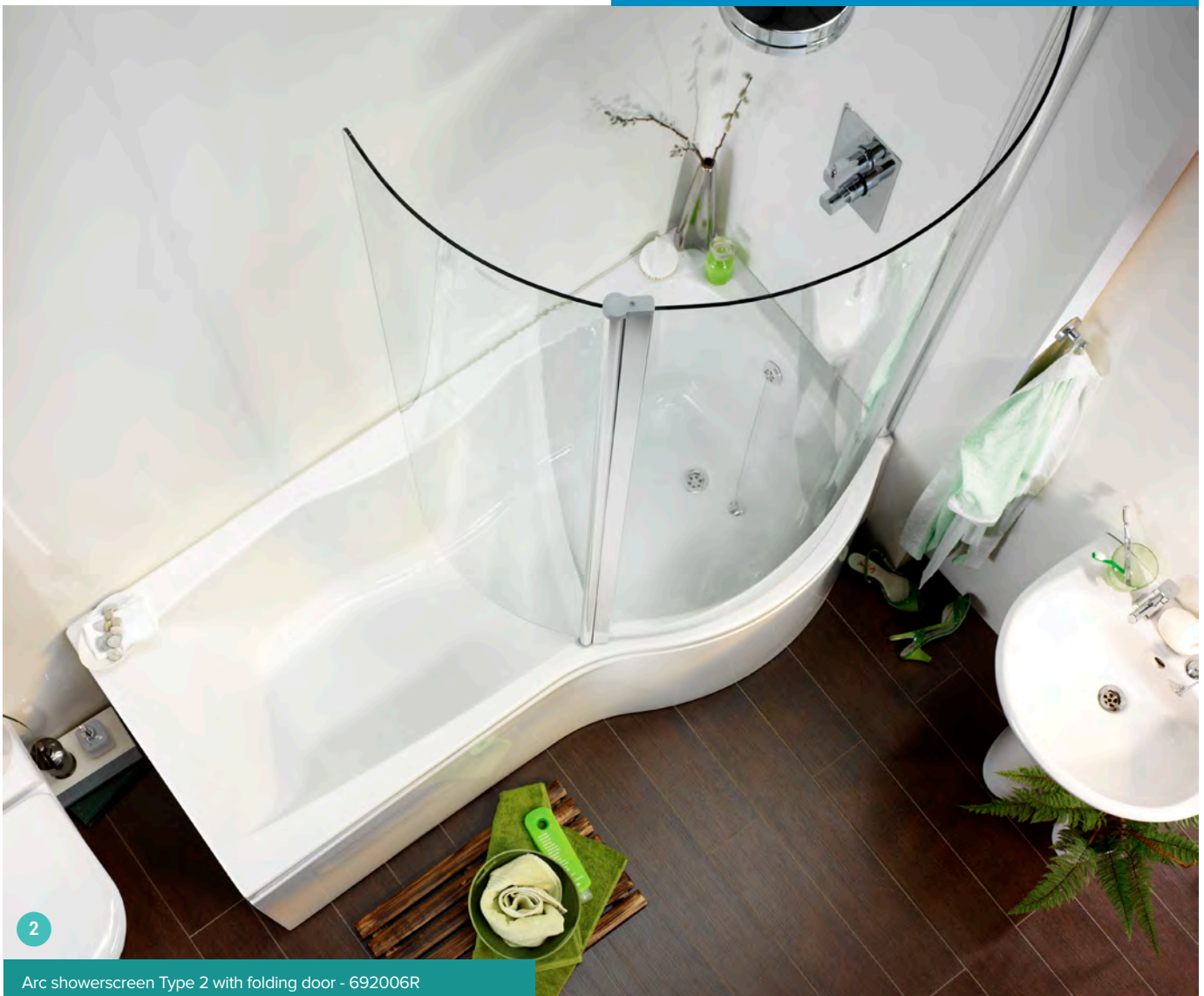

Arc showerscreen Type 2 with folding door - 692006R

The Arc showerbath has striking contoured lines and a wide curved end allowing comfortable, luxurious bathing and showering. Available with two shower screen options.

1700 x 845 x 430mm		250 Litres	
Description	Code	£ Ex VAT	£ Inc VAT
Arc 1700 x 845 RH 5mm	23.4571R	396.00	475.20
Arc 1700 x 845 LH 5mm	23.4571L	396.00	475.20
Arc 1700 x 845 RH Carronite	23.5571R	635.00	762.00
Arc 1700 x 845 LH Carronite	23.5571L	635.00	762.00

PANELS

Front panel 1700 x 540	23.3181	118.00	141.60
Front panel 1700 x 540 C/nite	23.3191	248.00	297.60
End panel	23.1041	89.00	106.80
End panel Carronite	23.1821	121.00	145.20

This bath has a suspended panel.

ARC SHOWER SCREENS

Description	PR	Height	Code	£ Ex VAT	£ Inc VAT
Arc shower screen	1	1400mm	23.620	199.00	238.80
Arc Screen type 2, 1 folding door	2	1535mm	69.2006R	459.00	550.80
Arc Screen type 2, 1 folding door	2	1535mm	69.2006L	459.00	550.80
Arc Showerscreen 6mm Easyclean	-	1400mm	58.713	165.00	198.00

PR: picture reference.

FEATURES

- Bespoke whirlpool available
- Carronite baths have a 30 year guarantee
- No tap holes or waste fittings

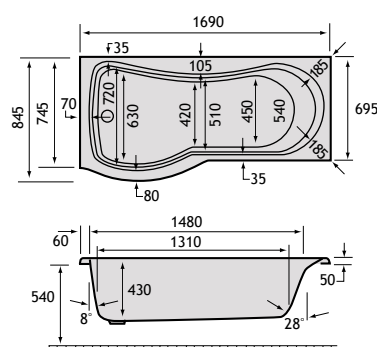
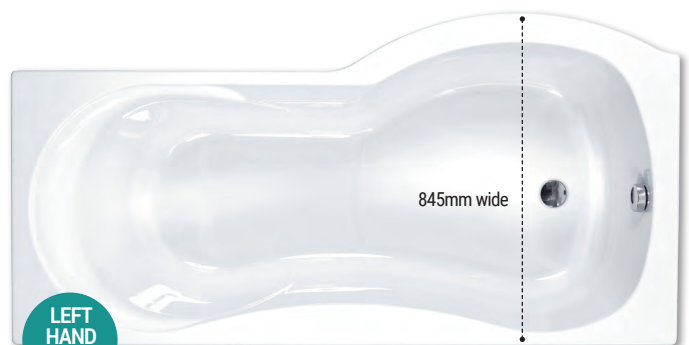

Showerbaths & Screens

SIGMA 1800 SHOWERBATH



Showerbaths & Screens

SIGMA 1800 SHOWERBATH

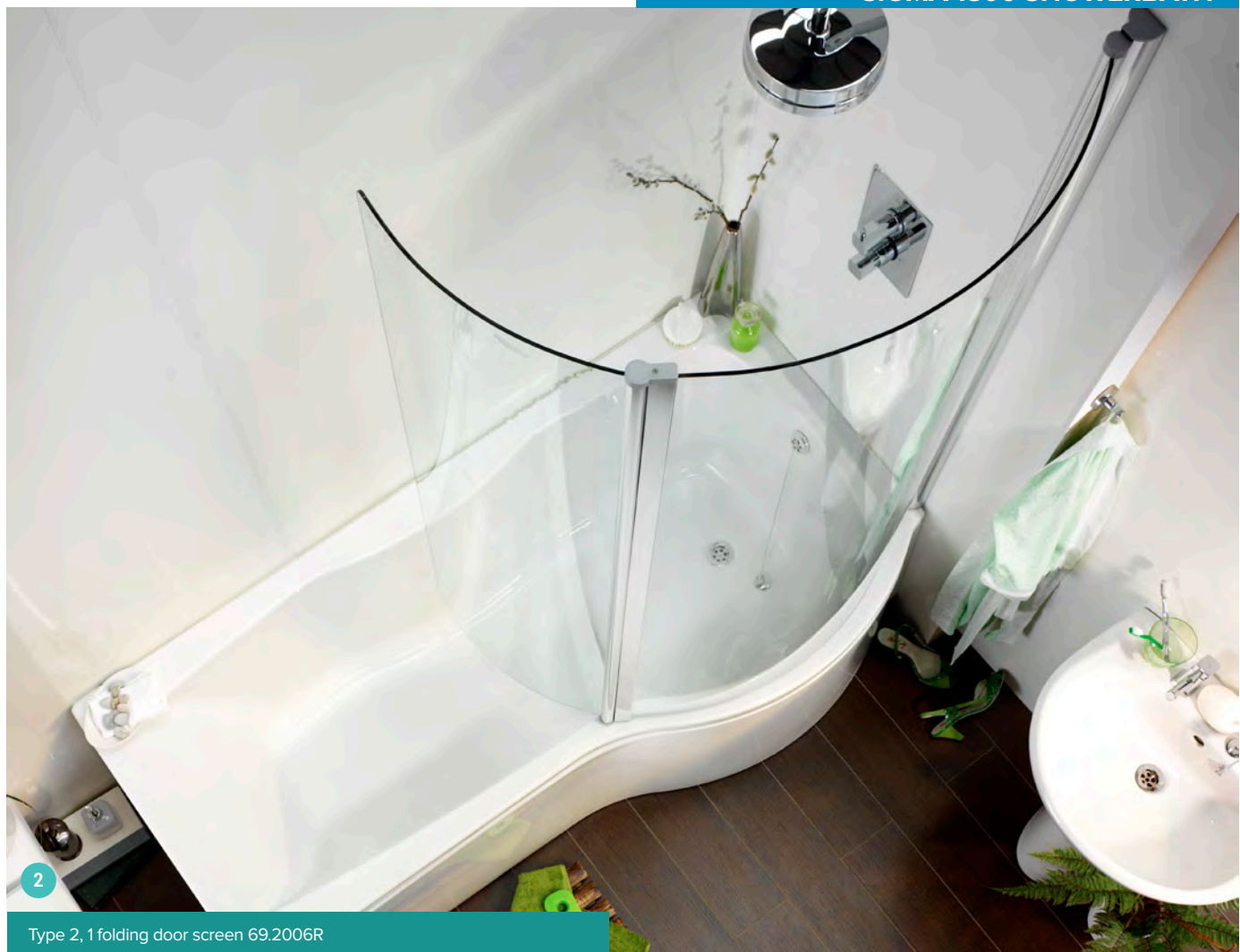

Type 2, 1 folding door screen 69.2006R

The Sigma shower bath is the epitome of style and comfort. Generously proportioned with elegant contours the Sigma really exudes luxury and offers a bathing experience second to none.

1800 x 900 x 450mm		265 Litres	
Description	Code	£ Ex VAT	£ Inc VAT
Sigma 1800 5mm RH	23.4121R	766.00	919.20
Sigma 1800 5mm LH	23.4121L	766.00	919.20
Sigma 1800 Carronite RH	23.5121R	1160.00	1392.00
Sigma 1800 Carronite LH	23.5121L	1160.00	1392.00
Headrest HR800	23.312	106.00	127.20

PANELS			
Description	Code	£ Ex VAT	£ Inc VAT
1800 front panel	23.1261	154.00	184.80
1800 front panel Carronite	23.1721	278.00	333.60
End panel	23.1251	89.00	106.80
End panel Carronite	23.1791	121.00	145.20

This bath has a suspended panel.

SIGMA SHOWER SCREENS

Description	PR	Height	Code	£ Ex VAT	£ Inc VAT
Arc Showerscreen 6mm Easyclean	-	1400mm	58.713	165.00	198.00
Sigma/Arc showerbath screen	4	1400mm	23.620	199.00	238.80
Sigma Screen type 1, 2 doors LH**	1	1530mm	69.2005L	409.00	490.80
Sigma Screen type 1, 2 doors RH**	1	1530mm	69.2005R	409.00	490.80
Sigma Screen type 2, 1 folding door RH	2	1535mm	69.2006R	459.00	550.80
Sigma Screen type 2, 1 folding door LH	2	1535mm	69.2006L	459.00	550.80
Sigma Screen type 3, sliding door Easy Clean	3	1575mm	69.2007	476.00	571.20

PR* picture reference **Installation tolerance allows for wall covering up to 12mm.

FEATURES

- Bespoke whirlpool available
- Ideal for showering
- Optional headrest available
- No tap holes or waste fittings
- Carronite baths have a 30 year guarantee

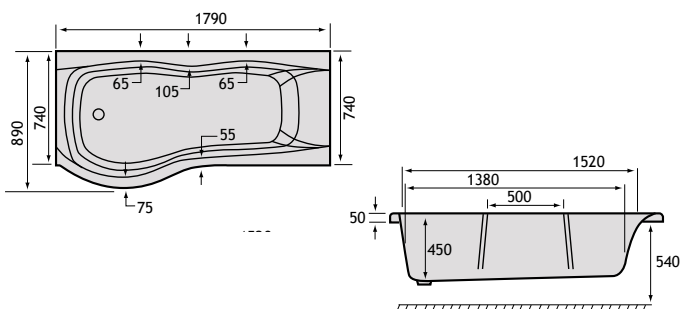
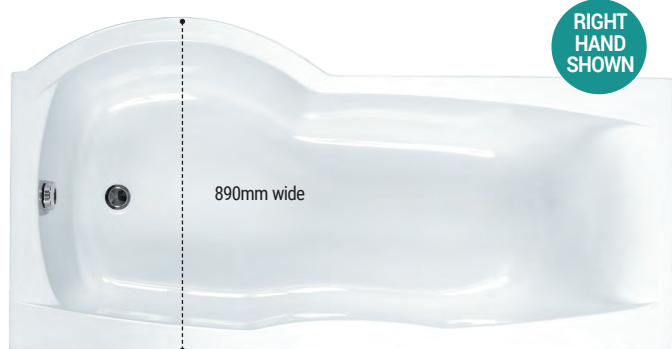

Freestanding Baths

HALCYON ROUND

Head Rest 



Make a dramatic statement with either red or black version

Taps for illustration purposes only.

This elegant and minimalist design is the perfect centre piece for a larger bathroom. It is available as the stunning freestanding option, pictured here, which comes in Carronite only, with waste and overflow pre-fitted for ease of installation. The second option is an inset version designed specifically to be built-in, and is available in both regular and Carronite strength, pictured page 85.

1750 x 800 x 450mm		270 Litres	
Description	Code	£ Ex VAT	£ Inc VAT
1750 x 800 White	23.3081	1586.00	1903.20
1750 x 800 White/Black	23.3084	1586.00	1903.20
1750 x 800 White/Red	23.3085	1586.00	1903.20
Freestanding Overflow Filler*	23.624	152.00	182.40
Universal PU Gel Headrest	84.0000	55.00	66.00

*Can be fitted with a Free-flow filler as a special order, code: 23.624 to be ordered with the freestanding bath (six week special order). NB Fillers cannot be ordered separately.

FEATURES

- No tap holes
- Waste and overflow pre-fitted
- Carronite baths have a 30 year guarantee
- Optional headrest available

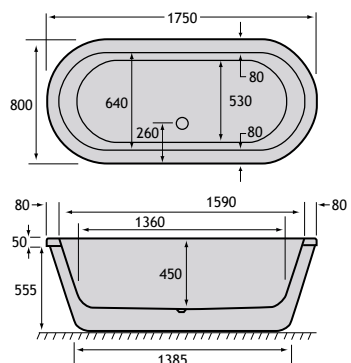

Freestanding Baths

HALCYON SQUARE

Head Rest 



Taps for illustration purposes only.

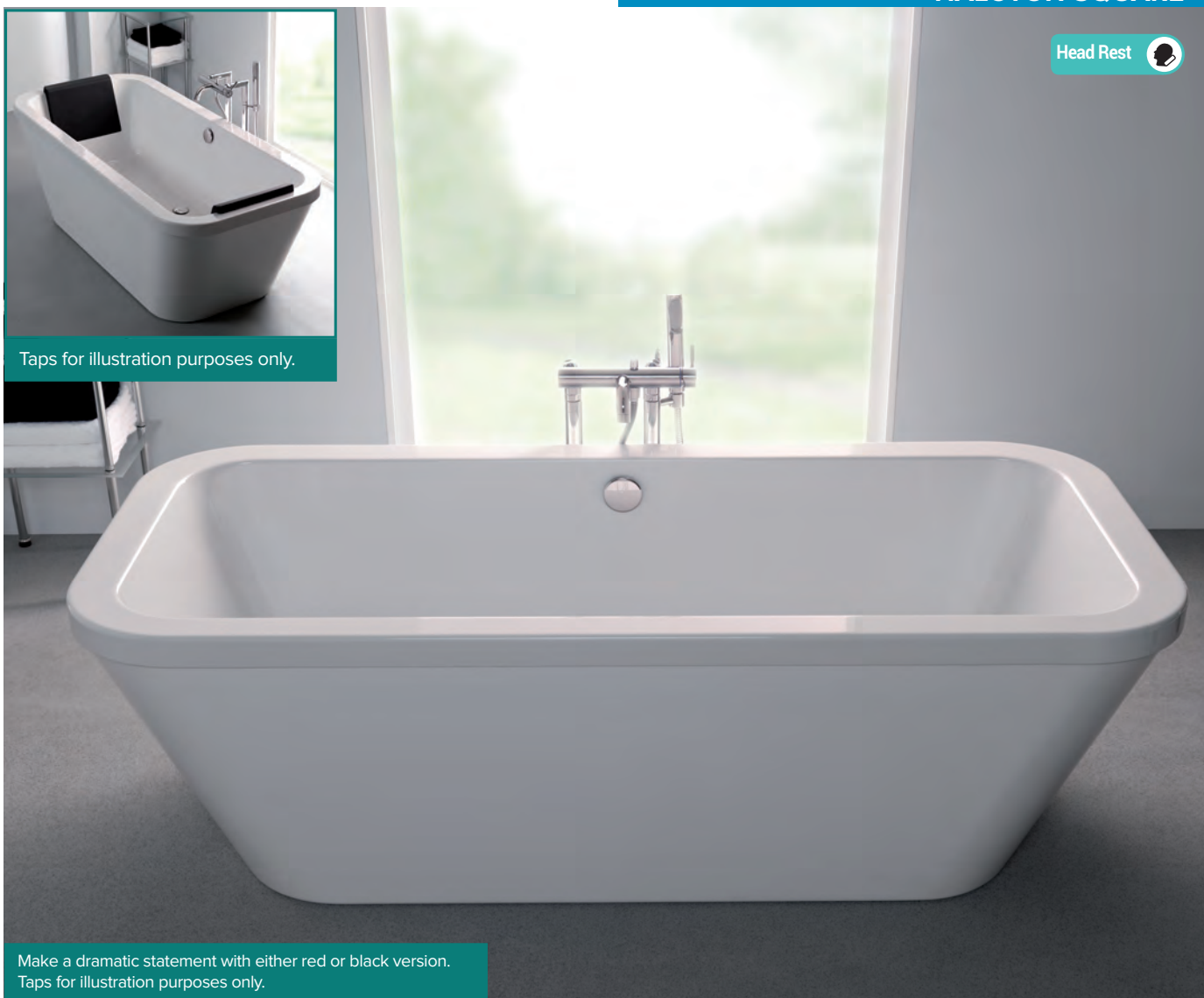

Make a dramatic statement with either red or black version. Taps for illustration purposes only.

A bold and eye-catching design deserves centre stage in a larger bathroom. Available as the stunning freestanding option, pictured here, which comes in Carronite only, with waste and overflow pre-fitted for ease of installation.

1750 x 800 x 440mm		250 Litres	
Description	Code	£ Ex VAT	£ Inc VAT
1750 x 800 White	23.3221	1586.00	1903.20
1750 x 800 White/Black	23.3224	1586.00	1903.20
1750 x 800 White/Red	23.3225	1586.00	1903.20
HR900 Headrest	23.309	106.00	127.20
Freestanding Overflow Filler*	23.624	152.00	182.40

*Can be fitted with a Free-flow filler as a special order, code: 23.624 to be ordered with the freestanding bath (six week special order). NB Fillers cannot be ordered separately.

FEATURES

- Optional headrest available
- Waste and overflow pre fitted
- No tap holes
- Carronite baths have a 30 year guarantee

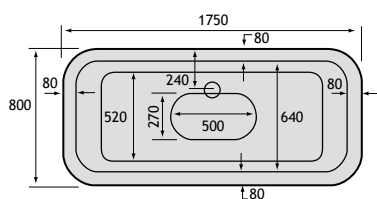

Freestanding Baths

HIGHGATE FREESTANDING BATH

Head Rest 



HIGHGATE

A freestanding version of the art deco inspired bath that combines style with functionality.

1750 x 800 x 630mm **265 Litres**

Description	Code	£ Ex VAT	£ Inc VAT
Highgate freestanding bath	23.6011	1929.00	2314.80

FEATURES

- Supplied with waste and overflow pre-fitted
- Carronite baths have a 30 year guarantee
- Optional headrest available

Head-rests available for all baths



Description	Code	£ Ex VAT	£ Inc VAT
Universal Foam Headrest	84.0001	28.00	33.60
Universal PU Gel Headrest	84.0000	55.00	66.00

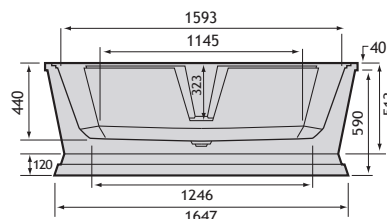
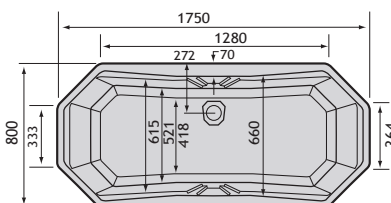

Freestanding Baths

PARADIGM FREESTANDING BATH

Head Rest 



If a paradigm shift is a change in basic assumptions, then the latest original design from Carron is perfectly named. Freestanding baths are usually assumed to be a feature of a larger bathroom.

The shorter length of the Paradigm opens up the freestanding option to a larger market to include smaller spaces. What the Paradigm loses in length, it more than makes up for in luxurious depth, for a long relaxing soak.

This bath comes with waste and overflow pre-fitted for ease of installation. It is also available with a filler, overflow and pop-up waste.

1550 x 850 x 430mm		238 Litres	
Description	Code	£ Ex VAT	£ Inc VAT
Paradigm Freestanding	23.3601	1586.00	1903.20
Paradigm Freestanding with filler	23.3641	1738.00	2085.60

FEATURES

- Waste and overflow pre-fitted
- Optional filler
- Carronite baths have a 30 year guarantee

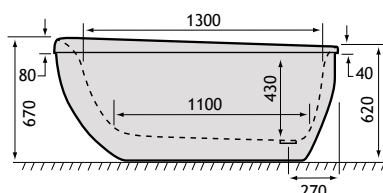
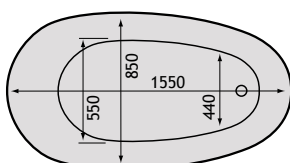

Freestanding Baths

CELSIUS FREESTANDING

Head Rest 



A stunning focal point in the larger bathroom. Supplied with a free flow filler, it will require a valve to operate the filler.

1900 x 910 x 450mm	330 Litres		
Description	Code	£ Ex VAT	£ Inc VAT
1900 x 910 freestanding bath	57.0001	1929.00	2314.80

FEATURES

- Supplied with free flow filler
- Waste pre-fitted
- Carronite baths have a 30 year guarantee

Head-rests available for all baths



Description	Code	£ Ex VAT	£ Inc VAT
Universal Foam Headrest	84.0001	28.00	33.60
Universal PU Gel Headrest	84.0000	55.00	66.00

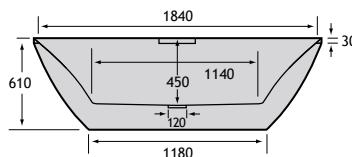
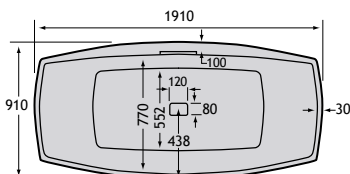

Offset Baths

VOLENTE 1000 & 1250 SCREENS



Panel for illustration purpose only

A universal screen which will fit a corner, offset corner or straight bath. It has a continuous wiper seal on the bottom and the folding section is operated by an inter-linking, 360° cog assembly.

1900 x 910 x 450mm		330 Litres	
Description	Code	£ Ex VAT	£ Inc VAT
Volente 1000 4 fold screen	58.700	131.00	157.20
Volente 1250 5 fold screen	58.701	162.00	194.40



Offset Baths

CLIPPER OFFSET

Shower 

Whirl Pool 

Head Rest 

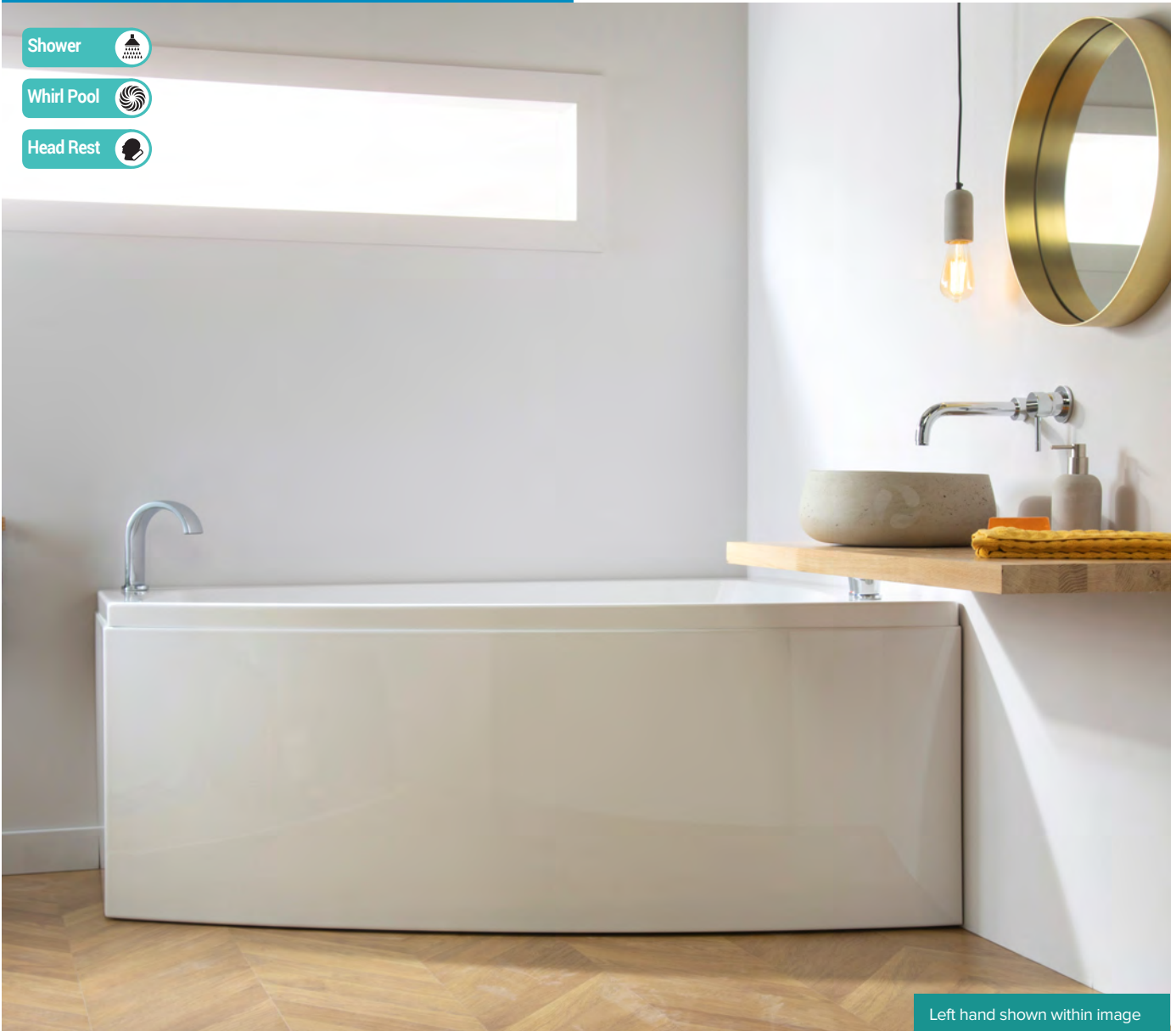

Left hand shown within image

A scandinavian style bath with deep luxurious proportions and contemporary lines adding a sophisticated touch of indulgence to your bathroom.

1575 x 1200 x 447-475mm **335 Litres**

Description	Code	£ Ex VAT	£ Inc VAT
1575 x 1200 5mm RH	23.6032	589.00	706.80
1575 x 1200 5mm LH	23.6031	589.00	706.80
1575 x 1200 Carronite RH	23.6034	834.00	1000.80
1575 x 1200 Carronite LH	23.6033	834.00	1000.80

PANELS

1575 x 1200 Carronite L-panel	23.6035	285.00	342.00
-------------------------------	---------	--------	---------------

Head-rests available for all baths



Description	Code	£ Ex VAT	£ Inc VAT
Universal Foam Headrest	84.0001	28.00	33.60
Universal PU Gel Headrest	84.0000	55.00	66.00

FEATURES

- No tap holes or waste fittings
- Carronite baths have a 30 year guarantee

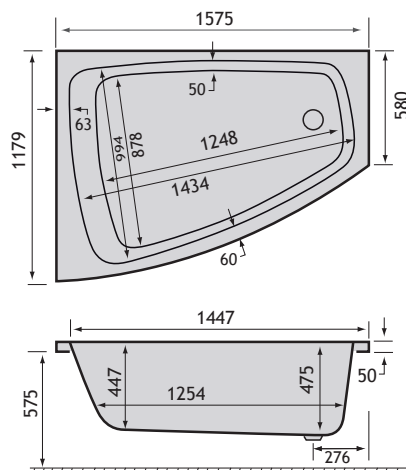

RIGHT HAND SHOWN

Offset Baths

DOVE OFFSET

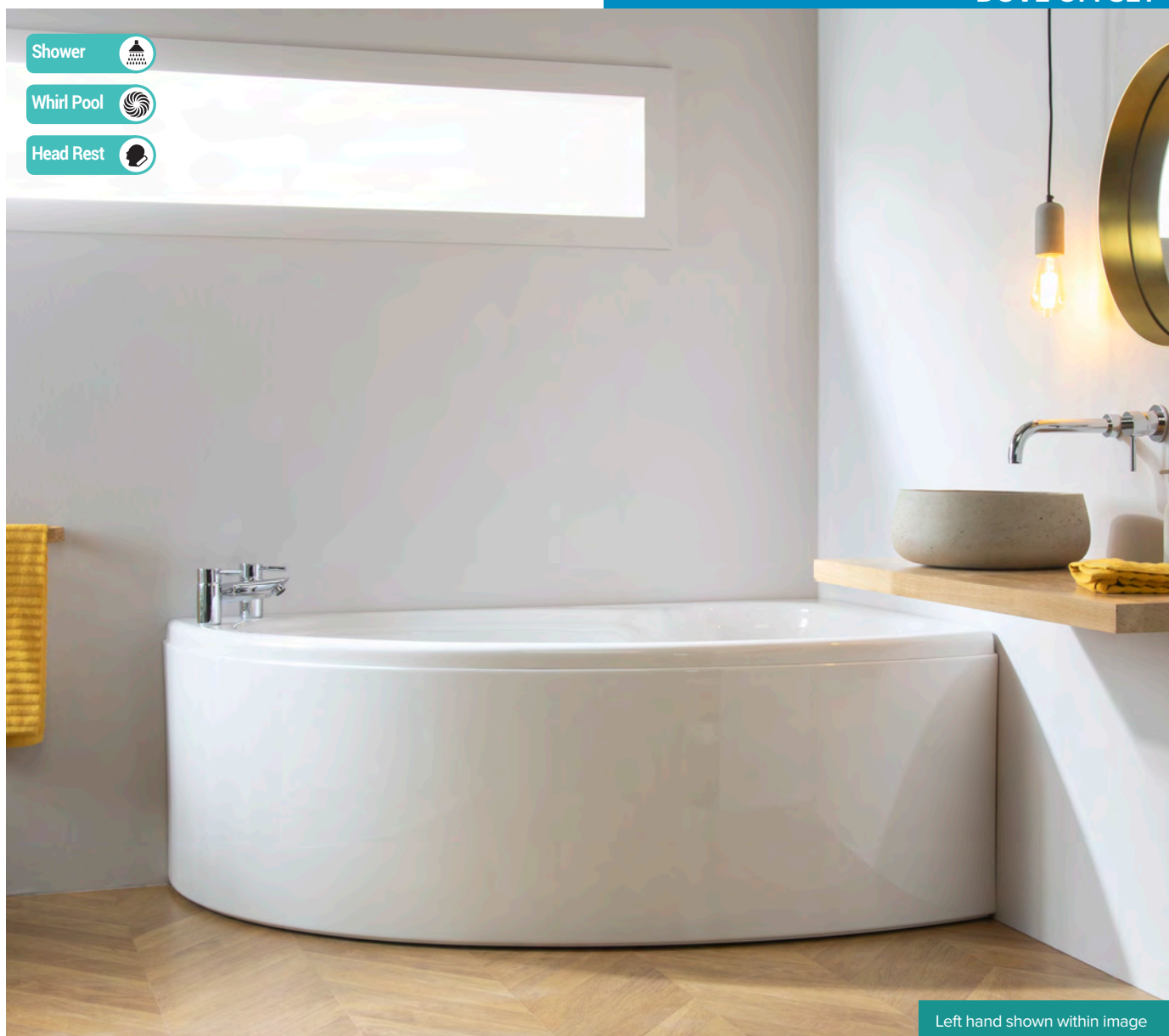

Thanks to its unique design, the beautiful Dove bath is small on the outside but surprisingly large on the inside. An offset corner bath that occupies modest space in your bathroom.

1550 x 950 x 400mm		190 Litres	
Description	Code	£ Ex VAT	£ Inc VAT
1550 x 950 5mm RH	23.0381R	589.00	706.80
1550 x 950 5mm LH	23.0381L	589.00	706.80
1550 x 950 Carronite RH	23.2381R	834.00	1000.80
1550 x 950 Carronite LH	23.2381L	834.00	1000.80

PANELS

1550 x 540 Carronite panel	23.1661	285.00	342.00
1550 x 540 Affinity panel	23.1851	150.00	180.00

This bath has a suspended panel.

FEATURES

- No tap holes or waste fittings
- Carronite baths have a 30 year guarantee

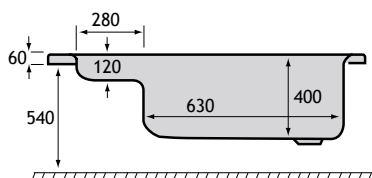
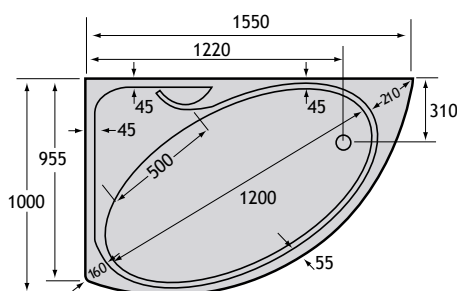

Offset Corner Baths

SWAN OFFSET

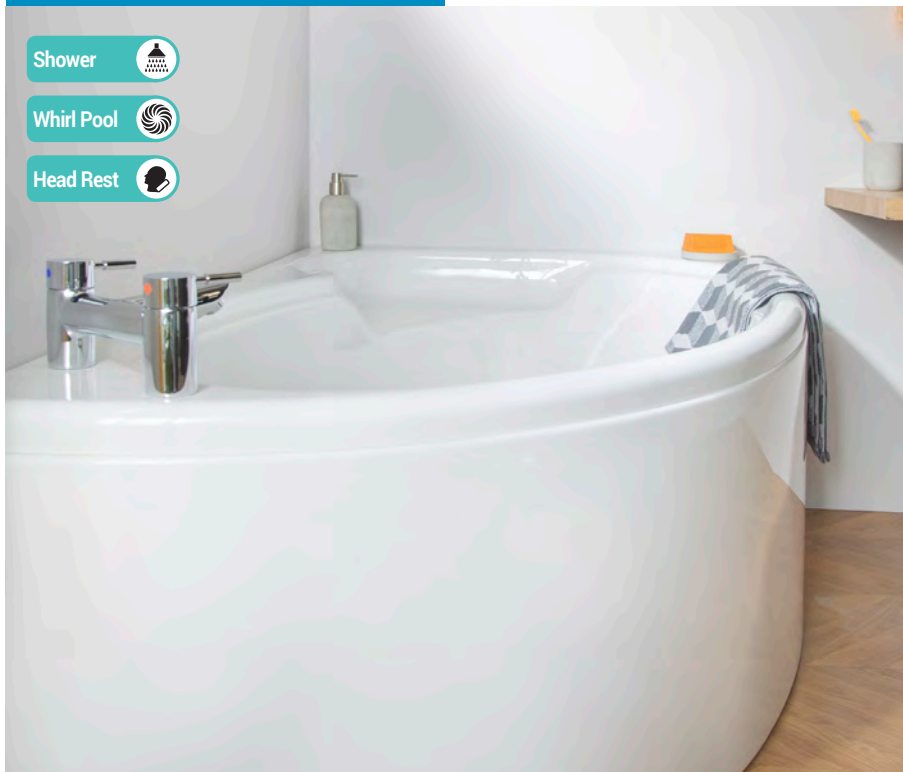

Shower 

Whirl Pool 

Head Rest 

By scaling up its width and length, the designers of this bath have created an amazing bathing area within this 1700mm long bath

1700 x 1000 x 415mm		225 Litres	
Description	Code	£ Ex VAT	£ Inc VAT
1700 x 1000 5mm RH	23.0921R	783.00	939.60
1700 x 1000 5mm LH	23.0921L	783.00	939.60
1700 x 1000 Carronite RH	23.2921R	1278.00	1533.60
1700 x 1000 Carronite LH	23.2921L	1278.00	1533.60

PANELS

1700 x 540 Carronite panel	23.1671	285.00	342.00
1700 x 540 Affinity panel	23.1861	150.00	180.00

This bath has a suspended panel.

FEATURES

- No tap holes or waste fittings
- Carronite baths have a 30 year guarantee

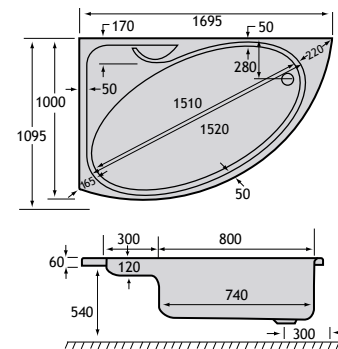

VOLENTE 1000 & 1250 BATH SCREEN

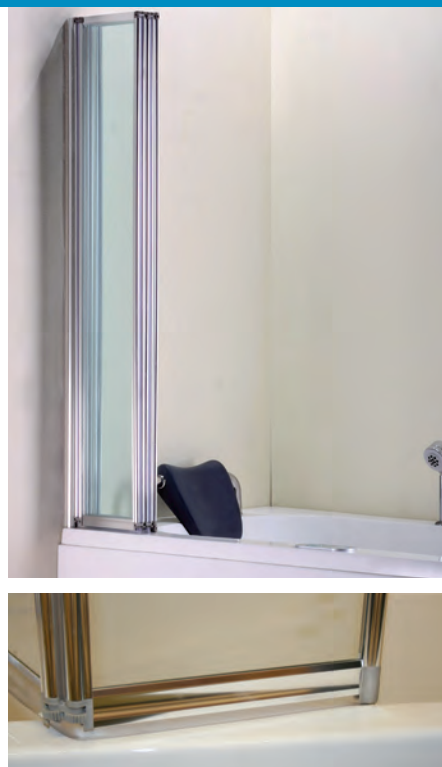

A universal screen which will fit a corner, offset corner or straight bath. It has a continuous wiper seal on the bottom and the folding section is operated by an inter-linking, 360° cog assembly.

1000 & 1250 Screens

Description	Code	£ Ex VAT	£ Inc VAT
Volente 1000 4 fold screen	58.700	131.00	157.20
Volente 1250 5 fold screen	58.701	162.00	194.40

Head-rests available for all baths



Description	Code	£ Ex VAT	£ Inc VAT
Universal foam headrest	84.0001	28.00	33.60
Universal PU Gel Headrest	84.0000	55.00	66.00

Offset Corner Baths

RIO CORNER BATH

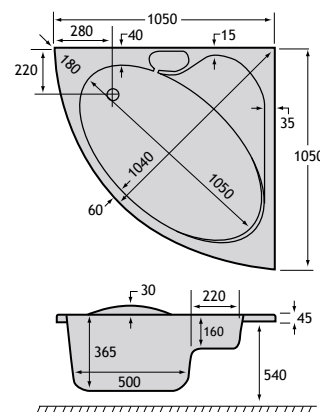

The Rio offers a stylish design and a large bathing area, while being an ideal corner bath for smaller spaces.

1050 x 1050 x 360mm		120 Litres	
Description	Code	£ Ex VAT	£ Inc VAT
1050 x 1050 5mm	23.0301	621.00	745.20
1050 x 1050 Carronite	23.2301	837.00	1004.40

PANELS

1050 x 540 Affinity panel	23.1741	150.00	180.00
1050 x 540 Carronite panel	23.1871	285.00	342.00

FEATURES

- No tap holes or waste fittings
- Carronite baths have a 30 year guarantee

BALI CORNER BATH

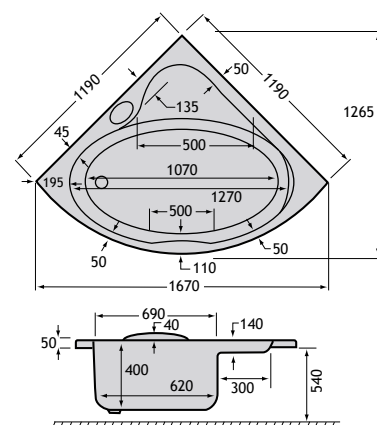
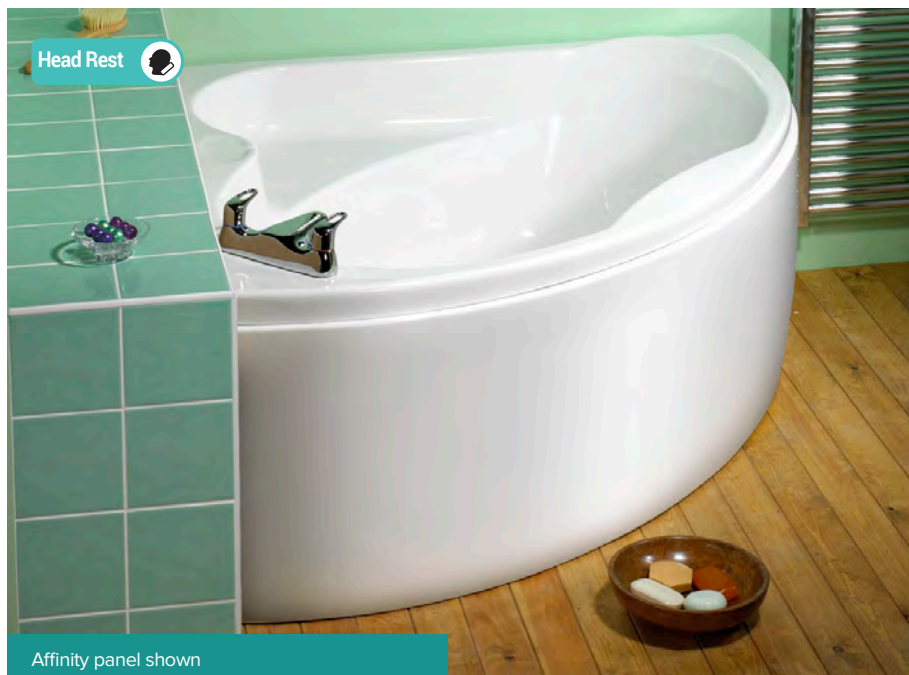

You can still have a stylish corner bath even if you only have modest space available. This bath has a generous bathing area and seat incorporated into its attractive design.

1200 x 1200 x 400mm		190 Litres	
Description	Code	£ Ex VAT	£ Inc VAT
1200 x 1200 5mm	23.0291	624.00	748.80
1200 x 1200 Carronite	23.2291	1140.00	1368.00

PANELS

1200 x 540 Affinity panel	23.1831	150.00	180.00
1200 x 540 Carronite panel	23.1881	285.00	342.00

This bath has a suspended panel.

FEATURES

- No tap holes or waste fittings
- Carronite baths have a 30 year guarantee

Corner Baths

ORIOLE



Head Rest 

This beautifully designed corner bath with built-in moulded arm rest is perfect for comfortable, stylish bathing.

1200 x 1200 x 400mm		190 Litres	
Description	Code	£ Ex VAT	£ Inc VAT
1200 x 1200 5mm	23.0311	627.00	752.40
1200 x 1200 Carronite	23.2311	798.00	957.60

PANELS

1200 x 540 Affinity panel	23.1831	150.00	180.00
1200 x 540 Carronite panel	23.1881	285.00	342.00

This bath has a suspended panel.

FEATURES

- No tap holes or waste fittings
- Carronite baths have a 30 year guarantee

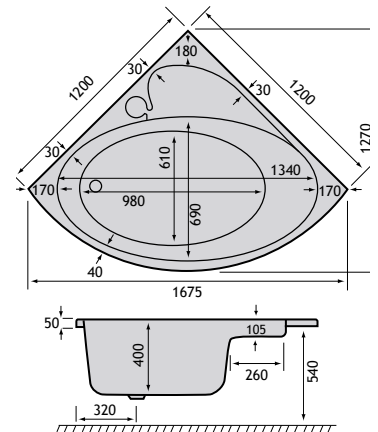

MONARCH



Whirl Pool 

Head Rest 

Affinity panel shown

A magnificent example of a corner bath, Monarch's smooth curves are pleasing to the eye, while its spacious design offers highly comfortable bathing.

1300 x 1300 x 400mm		205 Litres	
Description	Code	£ Ex VAT	£ Inc VAT
1300 x 1300 5mm	23.0321	671.00	805.20
1300 x 1300 Carronite	23.2321	848.00	1017.60

PANELS

1300 x 540 Affinity panel	23.1841	150.00	180.00
1300 x 540 Carronite panel	23.1681	285.00	342.00

FEATURES

- Bespoke whirlpool available
- No tap holes or waste fittings
- Carronite baths have a 30 year guarantee
- Stock carronite 6 jet clenda whirlpool available page 171

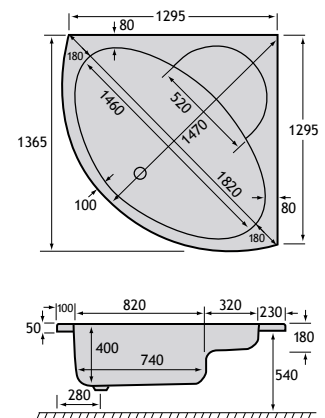

Corner Baths

TRANQUILITY



Whirl Pool 

Head Rest 

Here's a bath to blow your mind away. Subtle integrated curves with ideal areas for tap and whirlpool control all in a minimalist contemporary design.

1300 x 1300 x 450mm		295 Litres	
Description	Code	£ Ex VAT	£ Inc VAT
1300 x 1300 5mm	23.4291	725.00	870.00
1300 x 1300 Carronite	23.5291	1144.00	1372.80

PANELS

1300 x 540 Affinity panel	23.1841	150.00	180.00
1300 x 540 Carronite panel	23.1681	285.00	342.00

This bath has a suspended panel.

FEATURES

- Bespoke whirlpool available
- No tap holes or waste fittings
- Carronite baths have a 30 year guarantee

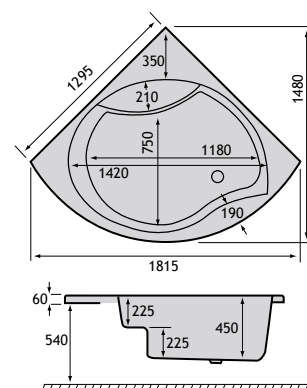

CENTENNIAL



Whirl Pool 

Head Rest 

If you desire a larger corner bath that will be the envy of your friends, this is the bath for you. Not only a beautiful addition to your bathroom but a chance to indulge in that special bathing experience.

1500 x 1500 x 500mm		407 Litres	
Description	Code	£ Ex VAT	£ Inc VAT
1500 x 1500 5mm	23.0911	870.00	1044.00
1500 x 1500 Carronite	23.2911	1278.00	1533.60

This bath has a suspended panel.

PANELS

1500 x 570 Panel	23.1161	150.00	180.00
1500 x 570 Carronite panel	23.1691	285.00	342.00

ACCESSORIES

Shallow Profile Bath Filler	2.015	204.00	244.80
-----------------------------	-------	--------	---------------

FEATURES

- Bespoke whirlpool available
- No tap holes or waste fittings
- Carronite baths have a 30 year guarantee
- Can be fitted with an overflow filler 2.015

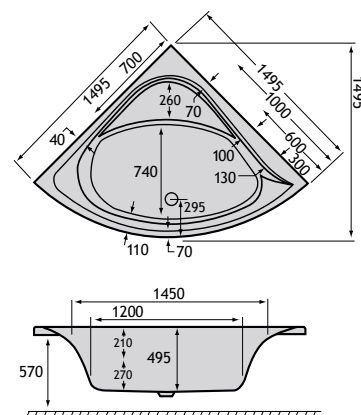



Panels & Screens

A large range of bath panels in a variety of contemporary styles and finishes. Many overbath shower screens in 5-8mm tempered glass, hinged, folded and fixed in clear or frosted glass.

Contents

Bath panels	136 - 141
Toilet seats	142
Bath shower screens	143 - 147



5mm Bath Panels

QUANTUM MODERN FLAT BATH PANEL



QUANTUM FRONT PANELS

Description	Code	£ Ex VAT	£ Inc VAT
Quantum Panel 1400 x 515	23.1028	96.00	115.20
Quantum Panel 1500 x 515	23.3231	96.00	115.20
Quantum Panel 1600 x 540	23.3521	93.00	111.60
Quantum Panel 1600 x 515	23.3241	96.00	115.20
Quantum Panel 1650 x 515	23.1029	96.00	115.20
Quantum Panel 1675 x 515	23.1030	96.00	115.20
Quantum Panel 1700 x 515	23.3251	96.00	115.20
Quantum Panel 1700 x 540	23.3261	107.00	128.40
Quantum Panel 1800 x 540	23.3271	114.00	136.80
Quantum Panel 1900 x 570	23.1045	114.00	136.80

CARRON UNIVERSAL END PANELS

Description	Code	£ Ex VAT	£ Inc VAT
Universal end panel 700 x 515	23.1611	76.00	91.20
Universal end panel 700 x 540	23.1621	76.00	91.20
Universal end panel 750 x 515	23.1601	76.00	91.20
Universal end panel 750 x 540	23.1631	76.00	91.20
Universal end panel 800 x 540	23.1641	76.00	91.20
Universal end panel 800 x 570	23.1191	84.00	100.80
Universal end panel 900 x 570	23.1651	84.00	100.80

CONCORD BATH PANEL

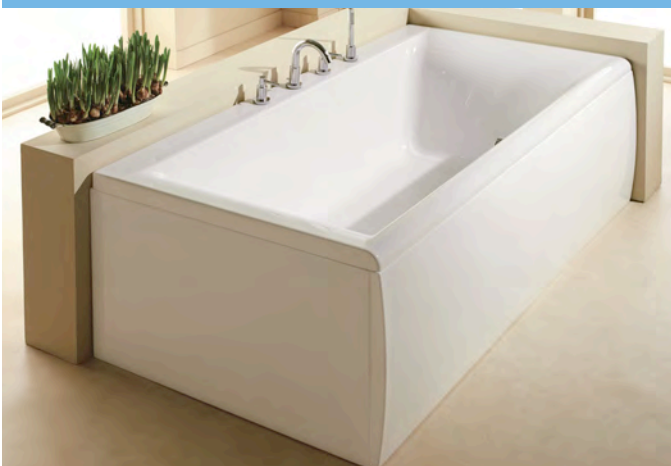

CONCORD FRONT PANELS

Description	Code	£ Ex VAT	£ Inc VAT
Concord panel 1700 x 540	23.1571	108.00	129.60
Concord panel 1800 x 540	23.1581	115.00	138.00

CARRON UNIVERSAL END PANELS

Description	Code	£ Ex VAT	£ Inc VAT
Universal end panel 700 x 515	23.1611	76.00	91.20
Universal end panel 700 x 540	23.1621	76.00	91.20
Universal end panel 750 x 515	23.1601	76.00	91.20
Universal end panel 750 x 540	23.1631	76.00	91.20
Universal end panel 800 x 540	23.1641	76.00	91.20
Universal end panel 800 x 570	23.1191	84.00	100.80
Universal end panel 900 x 570	23.1651	84.00	100.80

Carronite Bath Panels

L-SHAPED CARRONITE PANELS



L SHAPED CARRONITE PANELS

Description	Code	£ Ex VAT	£ Inc VAT
L shaped 1700 x 700 x 515	23.3571	273.00	327.60
L shaped 1700 x 700 x 540	57.1051	276.00	331.20
L shaped 1700 x 750 x 540	57.1061	276.00	331.20
L shaped 1800 x 800 x 540	57.1021	276.00	331.20

L SHAPED LOW LEVEL CARRONITE PANELS

Description	Code	£ Ex VAT	£ Inc VAT
L shaped 1500 x 700 x 430	23.1016	273.00	327.60
L shaped 1600 x 700 x 430	23.1017	273.00	327.60
L shaped 1700 x 700 x 430	23.1018	273.00	327.60



CARRONITE CONCORD PANELS



CARRONITE CONCORD PANELS

Description	Code	£ Ex VAT	£ Inc VAT
Carronite panel 1700 x 540	23.1381	146.00	175.20
Carronite panel 1800 x 540	23.1391	150.00	180.00

CARRONITE END PANELS

Description	Code	£ Ex VAT	£ Inc VAT
Carronite panel 700 x 515	23.1421	100.00	120.00
Carronite panel 700 x 540	23.1431	100.00	120.00
Carronite panel 750 x 515	23.3361	100.00	120.00
Carronite panel 750 x 540	23.1441	100.00	120.00
Carronite panel 800 x 515	23.3371	100.00	120.00
Carronite panel 800 x 540	23.1451	96.00	115.20
Carronite panel 900 x 540	23.1461	109.00	130.80



CARRONITE FRONT PANELS



QUANTUM CARRONITE FRONT PANELS

Description	Code	£ Ex VAT	£ Inc VAT
Front Panel Carronite 1400 x 515	23.1034	138.00	165.60
Front Panel Carronite 1500 x 515	23.3281	138.00	165.60
Front Panel Carronite 1600 x 540	23.3531	138.00	165.60
Front Panel Carronite 1600 x 515	23.3291	138.00	165.60
Front Panel Carronite 1650 x 515	23.1035	138.00	165.60
Front Panel Carronite 1675 x 515	23.1036	138.00	165.60
Front Panel Carronite 1700 x 515	23.3301	138.00	165.60
Front Panel Carronite 1700 x 540	23.3311	138.00	165.60
Front Panel Carronite 1800 x 540	23.3321	150.00	180.00
Front Panel Carronite 1900 x 570	23.1046	150.00	180.00



Sherwood Bath Panels

SHERWOOD™ BATH PANELS

A comprehensive quality range of wood effect bath panels, seats and vanity units. The latest vinyl wrapped technology is used to produce an extremely tough panel with colour matching guaranteed throughout the co-ordinated products.



Sherwood Original design



Sherwood Classic design



Sherwood Diamante design

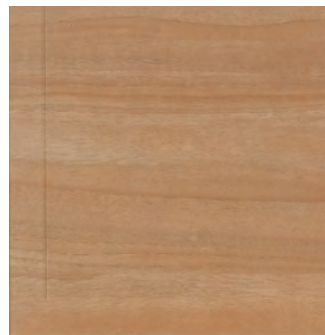

Sherwood Ultra design



Natural Oak

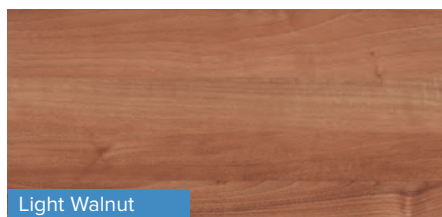

Light Walnut



Beech



Antique Pine



White Ash

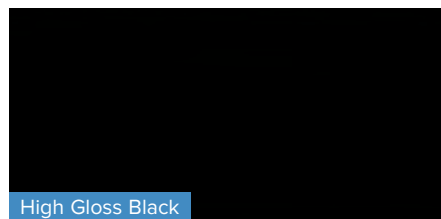

High Gloss Black



High Gloss White

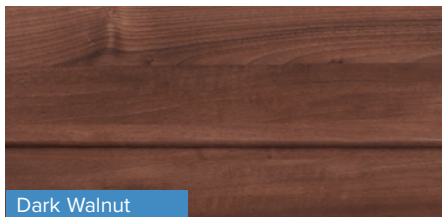

Dark Walnut

Sherwood is produced in four designs:

Sherwood Original with a traditional twist

Sherwood Classic for a more contemporary statement

Sherwood Diamante - a simple and modern design

Sherwood Ultra - a real gem in design combining both the Original and Classic values

Universal 18mm seats are available to compliment, complete with a high quality bar hinge, or the new soft close hinges.

All items are vinyl-wrapped MDF. Refer to style pages for finish availability.

Colours are subject to the limitations of the printing process. Colour samples available on request.

WAVE PANELS

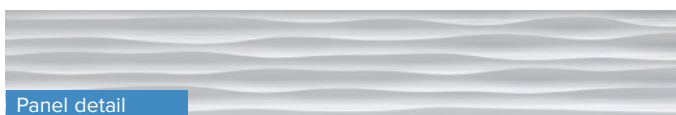
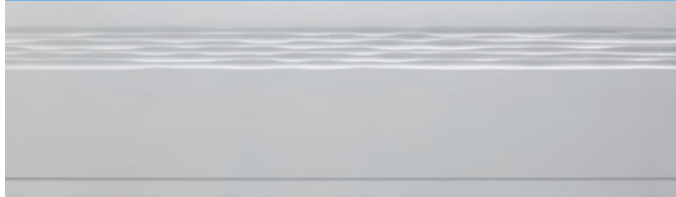

Panel detail

BATH PANELS

Description	Code	£ Ex VAT	£ Inc VAT
Wave 1700 front panel	29.0018	107.00	128.40
Wave 1800 front panel	29.0028	115.00	138.00
Wave 700 end panel	29.0038	61.00	73.20
Wave 750 end panel	29.0048	63.00	75.60
Wave 800 end panel	29.0058	65.00	78.00

NB. 700/750 panels can be obtained by cutting down the 800 panels. All 2-piece adjustable from 450 to 575 mm. Thickness 15mm. Plinth 140mm.

Sherwood Bath Panels



Natural Oak



White Ash



Antique Pine

SHERWOOD ORIGINAL BATH PANELS

Description	Natural oak	Antique pine	White ash	£ Ex VAT	£ Inc VAT
Sherwood original 1500 front bath panel	-	-	34.0035	84.00	100.80
Sherwood original 1600 front bath panel	-	-	34.0095	84.00	100.80
Sherwood original 1700 front bath panel	34.0043	34.0046	34.0045	84.00	100.80
Sherwood original 1800 front bath panel	34.0053	34.0056	34.0055	91.00	109.20
Sherwood original 800 end bath panel	34.0083	34.0086	34.0085	60.00	72.00

NB. All panels include extra deep plinth, allowing panel to be adjustable from 450mm to 575mm. The 800 mm universal end panel can be cut down to 700mm or 750mm size without loss of pattern.

Extra deep plinth allows panel to be adjustable in height from 450 to 575mm. Thickness 15mm. Plinth height 150mm.

FEATURES

- British manufactured
- FSC - All materials sourced from protected forests
- MDF
- Fully adjustable plinth



End Panel

SHERWOOD DIAMANTE



Light Walnut



High Gloss White

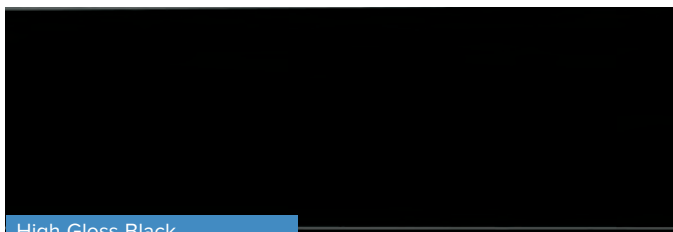

High Gloss Black

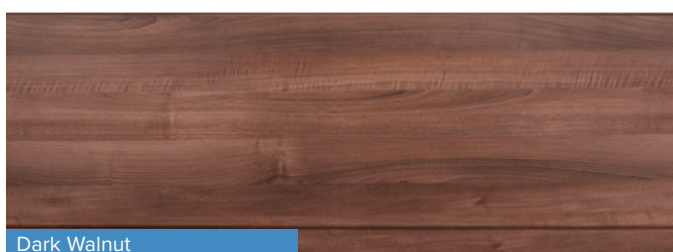

Dark Walnut

DIAMANTE BATH PANELS

Description	High gloss white	High gloss black	£ Ex VAT	£ Inc VAT
Diamante 1700 front panel	34.0701	34.07001	116.00	139.20
Diamante 1800 front panel	34.0711	34.07101	128.00	153.60
Diamante 800 end panel	34.0731	34.07301	91.00	109.20

Description	Light walnut	Dark walnut	£ Ex VAT	£ Inc VAT
Diamante 1700 front panel	34.01604	34.01605	84.00	100.80
Diamante 1800 front panel	34.01704	34.01705	93.00	111.60
Diamante 800 end panel	34.01904	34.01905	59.00	70.80

NB. 700/750 panels can be obtained by cutting down the 800 panels. All 2-piece adjustable from 450 to 575mm. Thickness 15mm. Plinth 150mm.

Colours are subject to the limitations of the printing process. Colour samples available on request.

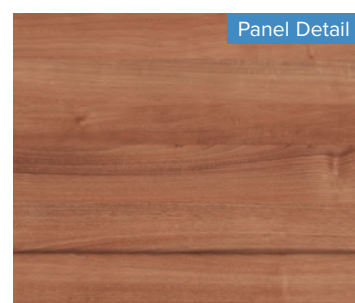

Panel Detail

Sherwood Classic & Ultra Bath Panels

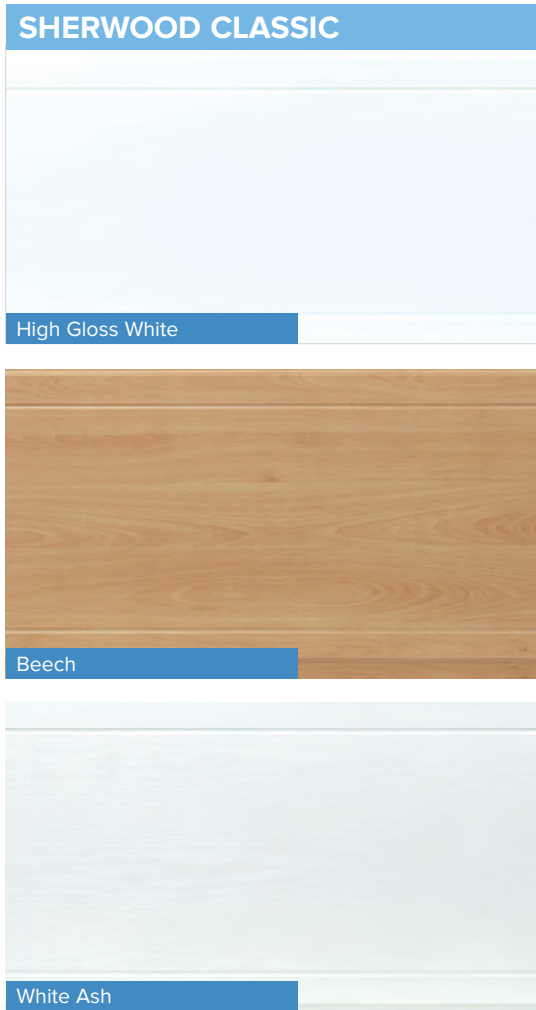

SHERWOOD CLASSIC BATH PANELS							
Description	High gloss white	£ Ex VAT	£ Inc VAT	White ash	Beech	£ Ex VAT	£ Inc VAT
Sherwood classic 1700 front panel	34.1048	109.00	130.80	34.1045	34.1047	84.00	100.80
Sherwood classic 1800 front panel	34.1058	121.00	145.20	34.1055	34.1057	91.00	109.20
Sherwood classic 800 universal end panel	34.1088	84.00	100.80	34.1085	34.1087	59.00	70.80

Colours are subject to the limitations of the printing process. Colour samples available on request.

FEATURES

- British manufactured
- FSC - All materials sourced from protected forests
- MDF
- Fully adjustable plinth

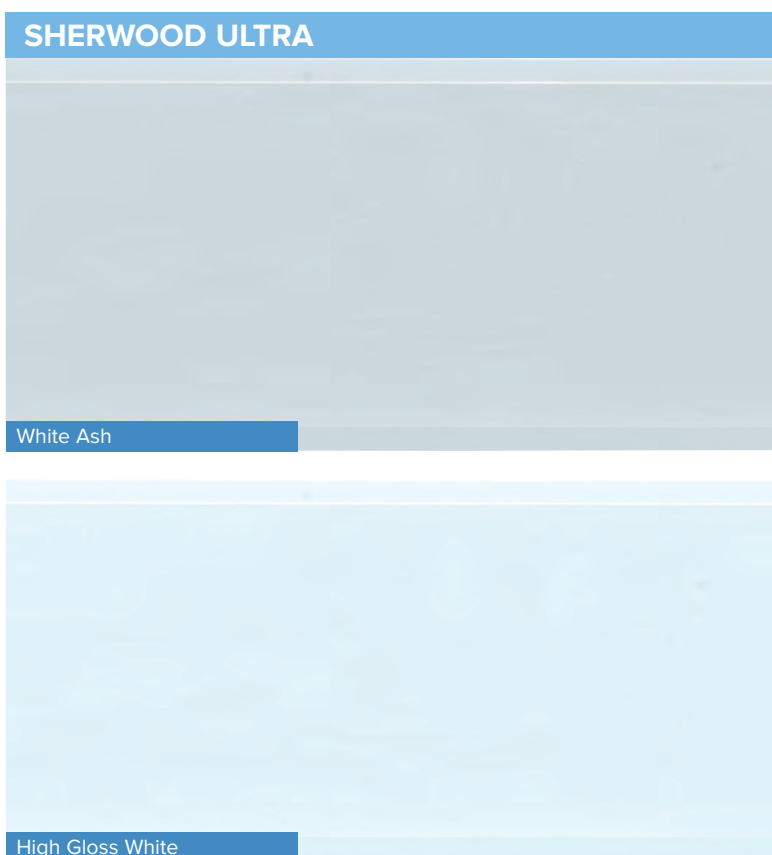

SHERWOOD ULTRA BATH PANELS						
Description	White ash	£ Ex VAT	£ Inc VAT	High gloss white	£ Ex VAT	£ Inc VAT
Ultra 1700 panel	34.0065	84.00	100.80	34.0068	109.00	130.80
Ultra 1800 panel	34.0135	91.00	109.20	34.0138	121.00	145.20
Ultra 800 panel	34.0075	59.00	70.80	34.0078	84.00	100.80

NB. All panels include extra deep plinth adjustable in height from 450-575mm. The 800 universal end panel can be cut down to 700mm or 750mm size.

Extra deep plinth allows panel to be adjustable in height from 450mm to 575mm.

Thickness 15mm. Plinth height 150mm.

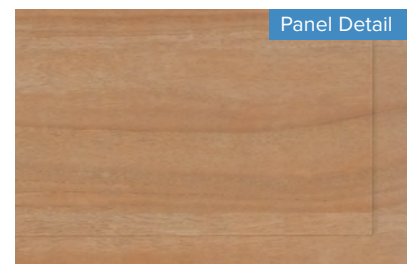

Diamante, Bonito & Acer Bath Panels

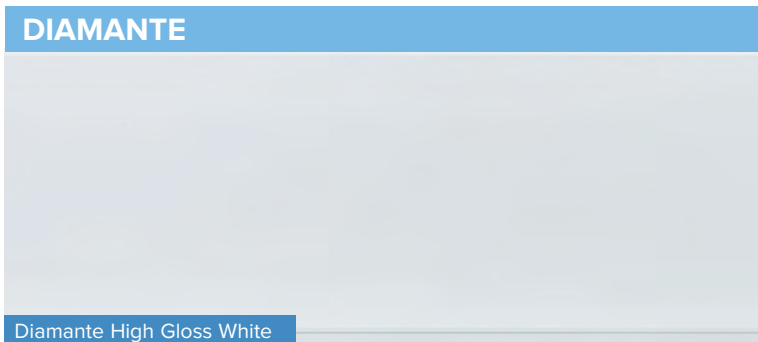

DIAMANTE BATH PANELS				
Description	Colour	Code	£ Ex VAT	£ Inc VAT
Diamante 1700 front panel	White	34.0701	116.00	139.20
Diamante 1700 front panel	HGB	34.07001	116.00	139.20
Diamante 1800 front panel	White	34.0711	128.00	153.60
Diamante 1800 front panel	HGB	34.07101	128.00	153.60
Diamante 800 end panel	White	34.0731	91.00	109.20
Diamante 800 end panel	HGB	34.07301	91.00	109.20

NB. 700/750 panels can be obtained by cutting down the 800 panels. All 2-piece adjustable from 450 to 575 mm. Thickness 15mm. Plinth 150mm.

High Gloss White MDF panels to match Madrid and Diamante Units

FEATURES

- British manufactured
- FSC - All materials sourced from protected forests
- MDF
- Fully adjustable plinth

White

High gloss MDF Bonito / Daisy panels

BATH PANELS				
Description	Colour	Code	£ Ex VAT	£ Inc VAT
Bonito/Daisy 1700 front panel	White	34.0161	109.00	130.80
Bonito/Daisy 1800 front panels	White	34.0171	121.00	145.20
Bonito/Daisy 800 end panels	White	34.0191	84.00	100.80

NB. 700/750 panels can be obtained by cutting down the 800 panels. All 2-piece adjustable from 450 to 575 mm. Thickness 15mm. Plinth 150mm



ACER BATH PANELS				
Description	Dark Walnut	Natural Oak	£ Ex VAT	£ Inc VAT
Acer 1700 front panel	29.00605	29.0063	117.00	140.40
Acer 1800 front panel	29.00705	29.0073	123.00	147.60
Acer 700 end panel	29.00805	29.0083	65.00	78.00
Acer 750 end panel	29.00905	29.0093	67.00	80.40
Acer 800 end panel	29.01005	29.0103	69.00	82.80

NB. 700/750 panels can be obtained by cutting down the 800 panels. All 2-piece adjustable from 450 to 575 mm. Thickness 15mm. Plinth 150mm

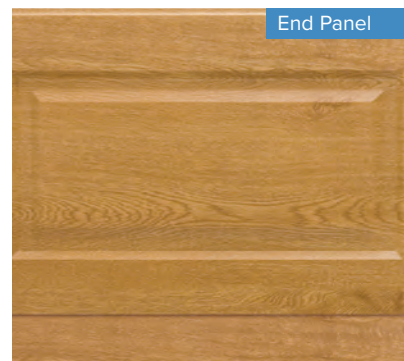

Toilet Seats

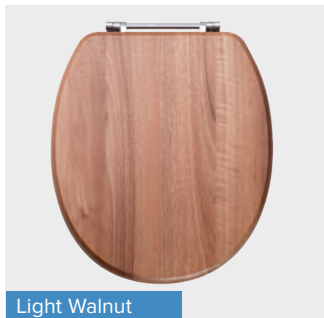

Light Walnut



White Ash

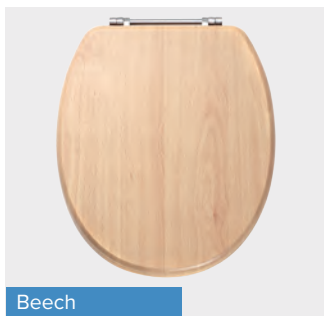

Beech

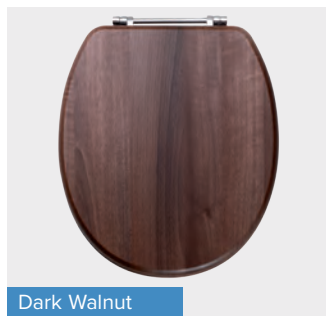

Dark Walnut

FEATURES

- British manufactured
- FSC - All materials sourced from protected forests
- MDF
- Soft close seat option available
- Soft close seat is top fixing



SHERWOOD TOILET SEATS

Suitable to match all Sherwood styles of panel with an option of a soft-close hinge.

Description	White Ash	Light Walnut	Beech	Dark Walnut	£ Ex VAT	£ Inc VAT
Sherwood MDF seat in vinyl wrap with chrome-plated bar hinges	34.1095	34.10904	34.1097	34.10905	66.00	79.20
Sherwood MDF seat in vinyl wrap with chrome plated soft-close hinges *	34.0125	34.01204	34.0127	34.01205	108.00	129.60

*Not bar hinges.

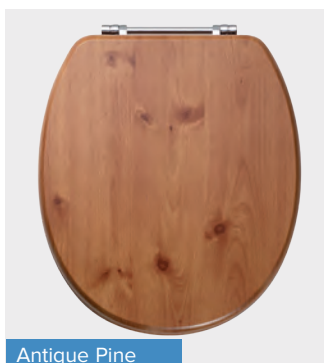

Antique Pine



High Gloss White

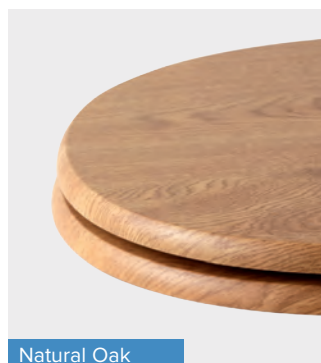

Natural Oak

FEATURES

- Soft close seat option available

Sherwood toilet seat 440mm (from back of hinge) x 375mm at widest point, 420mm x 375mm lid size.

Colours subject to the limitations of the printing process. Colour sample available on request.

SHERWOOD TOILET SEATS

Suitable to match all Sherwood styles of panel with an option of a soft-close hinge.

Description	Antique pine	Natural oak	£ Ex VAT	£ Inc VAT	High gloss white	£ Ex VAT	£ Inc VAT
Sherwood MDF seat in vinyl wrap with chrome-plated bar hinges	34.1096	34.1093	66.00	79.20	34.1098	78.00	93.60
Sherwood MDF seat in vinyl wrap with chrome plated soft-close hinges*	34.0126	34.0123	108.00	129.60	34.0128	117.00	140.40

*Not bar hinges.

DIAMANTE HIGH GLOSS TOILET SEAT

Description	Colour	White ash	£ Ex VAT	£ Inc VAT
Sherwood seat with Chrome hinges	HGB	34.10901	78.00	93.60
Sherwood seat soft close hinge	HGB	34.01201	117.00	140.40

NB. Soft close hinges are standard not bar type.

FEATURES

- Soft close seat option available

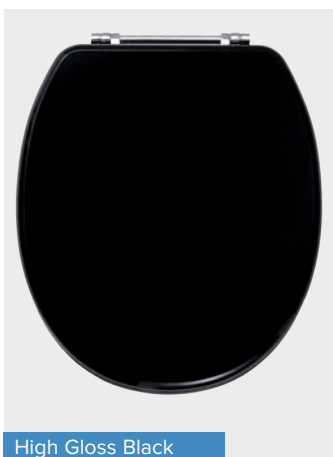

High Gloss Black

Volente Overbath Slider



FEATURES

- 6mm tempered glass
- Runners release for ease of cleaning
- Easy clean glass

VOLENTE OVERBATH SLIDER

Description (Width x Height)	Adjustment	Code	£ Ex VAT	£ Inc VAT
Volente 1690 x 1475 Overbath Slider 6mm, opening 690	1670-1690	69.0034	280.00	336.00
Volente 1790 x 1475 Overbath Slider 6mm, opening 740	1770-1790	69.0035	290.00	348.00
Volente 690 x 1475 Overbath End Panel	670-690	69.0036	123.00	147.60
Volente 740 x 1475 Overbath End Panel	720-740	69.0037	125.00	150.00



BATH SCREEN

Description	Code	£ Ex VAT	£ Inc VAT
Bathscreen 250mm Fixed 750mm Hinged 6mm	69.0164	198.00	237.60

FEATURES

- 6mm tempered glass
- 180° hinge
- 250mm fixed panel

Bath Screens



Description	Dimension width x height	Code	£ Ex VAT	£ Ex VAT	£ Inc VAT
Sail shape screen with towel rail	895 x 1410mm	69.701	180.00		216.00

FEATURES
• 5mm tempered glass



Description	Dimension width x height	Code	£ Ex VAT	£ Ex VAT	£ Inc VAT
Bathguard 300 x 1400mm 6mm clear glass	300 x 1400mm	58.715	79.00		94.80

FEATURES
• 6mm tempered glass

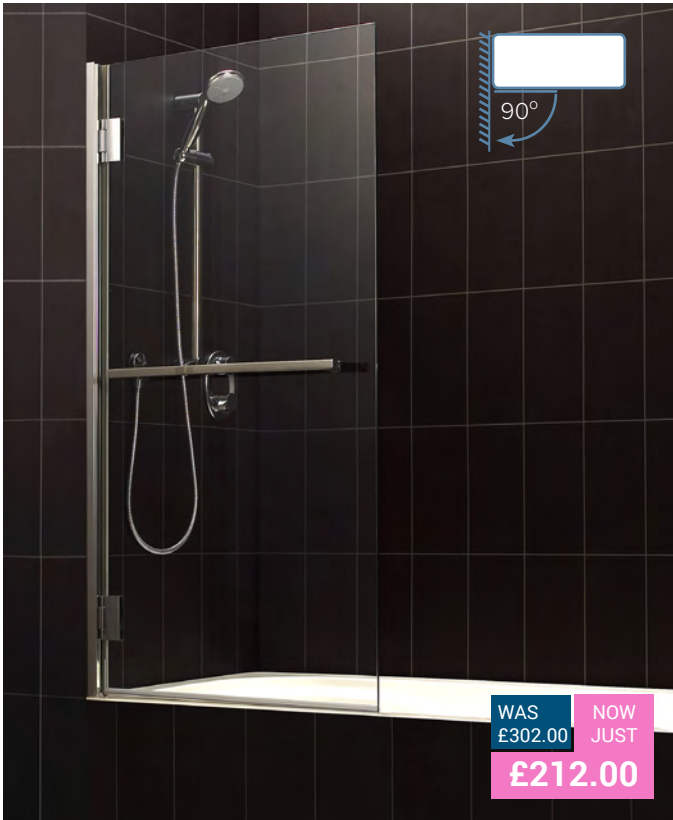

Description	Dimension width x height	Code	£ Ex VAT	£ Ex VAT	£ Inc VAT
Corniche bath screen with rail	800 x 1400mm	69.0142	78.00	212.00	254.40

FEATURES
• 8mm tempered glass



Description	Dimension width x height	Code	£ Ex VAT	£ Ex VAT	£ Inc VAT
Radius corner screen	750 x 1380mm	69.702	155.00		186.00

FEATURES
• 5mm tempered glass

Volente 1000 & 1250 Screens



VOLENTE

A universal screen which will fit a corner, offset corner or straight bath. It has a continuous wiper seal on the bottom and the folding section is operated by an inter-linking, 360° cog assembly. 1400 x 1000/1250mm with an adjustment of 990-1000/1240-1250, 5mm tempered glass.



Description	Dimension width x height	Code	£ Ex VAT	£ Inc VAT
Volente 1000 4 fold screen	1400 x 1000	58.700	131.00	157.20
Volente 1250 5 fold screen	1400 x 1250	58.701	162.00	194.40

FEATURES

- 5mm tempered glass



Right hand shown



Right hand shown

Description	Code	£ Ex VAT	£ Inc VAT
Volente 1000mm 1 fixed and 3 folding panel LH	58.710L	270.00	324.00
Volente 1000mm 1 fixed and 3 folding panel RH	58.710R	270.00	324.00

NB Panels fold over bath only. Only suitable for a bath with a flat rim.

FEATURES

- 6mm tempered glass
- Easy clean glass

Description	Code	£ Ex VAT	£ Inc VAT
Volente 1250mm 1 fixed and 4 folding panels LH	58.711L	338.00	405.60
Volente 1250mm 1 fixed and 4 folding panels RH	58.711R	338.00	405.60

NB Panels fold over bath only. Only suitable for a bath with a flat rim.

FEATURES

- 6mm tempered glass
- Easy clean glass

Volente Hinged Screens



Description	Dimension width x height	Code	£ Ex VAT	£ Inc VAT
Volente 2 part hinged screen easy-clean	1465 x 1550	58.706	290.00	348.00

Volente bath screen featuring one fixed panel and two hinged panels.

*Only suitable for a flat rimmed bath

FEATURES

- 6mm tempered glass
- Easy clean glass



Description	Dimension width x height	Code	£ Ex VAT	£ Inc VAT
Volente 1 fixed 2 hinge panel easy-clean	1475 x 1550	58.709	342.00	410.40

Volente bath screen featuring one fixed panel and two hinged panels.

*Only suitable for a flat rimmed bath

FEATURES

- 6mm tempered glass
- Easy clean glass



Quantum bath screen with two hinged panels.

QUANTUM SCREENS

Description	Code	£ Ex VAT	£ Inc VAT
Quantum screen 1400mm	58.4000	245.00	294.00
Quantum screen 1400mm with towel rail	69.0141	331.00	397.20



TYPE 1 SCREENS

Description	White ash	£ Ex VAT	£ Inc VAT
Type 1 Screen across bath for 700	58.716	129.00	154.80
Type 1 screen across bath for 750	58.717	132.00	158.40
Type 1 screen across bath for 800	58.718	136.00	163.20
Type 1 screen across bath for 900	58.719	141.00	169.20
Type 1 universal side screen	58.720	96.00	115.20

NB. Soft close hinges are standard not bar type.

Type 1 bath screen with two hinged panels - when fitting on a double ended bath ensure taps are mounted left or right of screen wall profile.

Volente Hinged Screens



Description	Dimension width x height	Code	£ Ex VAT	£ Inc VAT
Volente 6mm hinge bath screen easy clean	850 x 1500	58.702	158.00	189.60

- FEATURES**
- 6mm tempered glass
 - Easy clean glass



Description	Dimension width x height	Code	£ Ex VAT	£ Inc VAT
Volente 8mm hinge bath screen easy clean	850 x 1500mm	58.703	163.00	195.60

- FEATURES**
- 8mm tempered glass
 - Easy clean glass



Description	Dimension width x height	Code	£ Ex VAT	£ Inc VAT
Volente 6mm hinge bath screen frosted	850 x 1500mm	58.704	134.00	160.80

- FEATURES**
- 6mm tempered glass
 - Easy clean glass



Description	Dimension width x height	Code	£ Ex VAT	£ Inc VAT
Volente 8mm hinge bath screen frosted	850 x 1500mm	58.705	144.00	172.80

- FEATURES**
- 8mm tempered glass
 - Easy clean glass



Celsius Baths

Bold, cutting edge design concepts, the Celsius range of baths feature original technology advancements.

The sleek, sharp lines of the Celsius baths complement the latest market developments in ceramics and brassware. All Celsius baths are manufactured in Carron's unique, patented Carronite™ specification.

Contents

Straight baths	150 - 151
Shower baths	152
Luxury baths	153 - 155
Celsius c-lenda	156 - 159

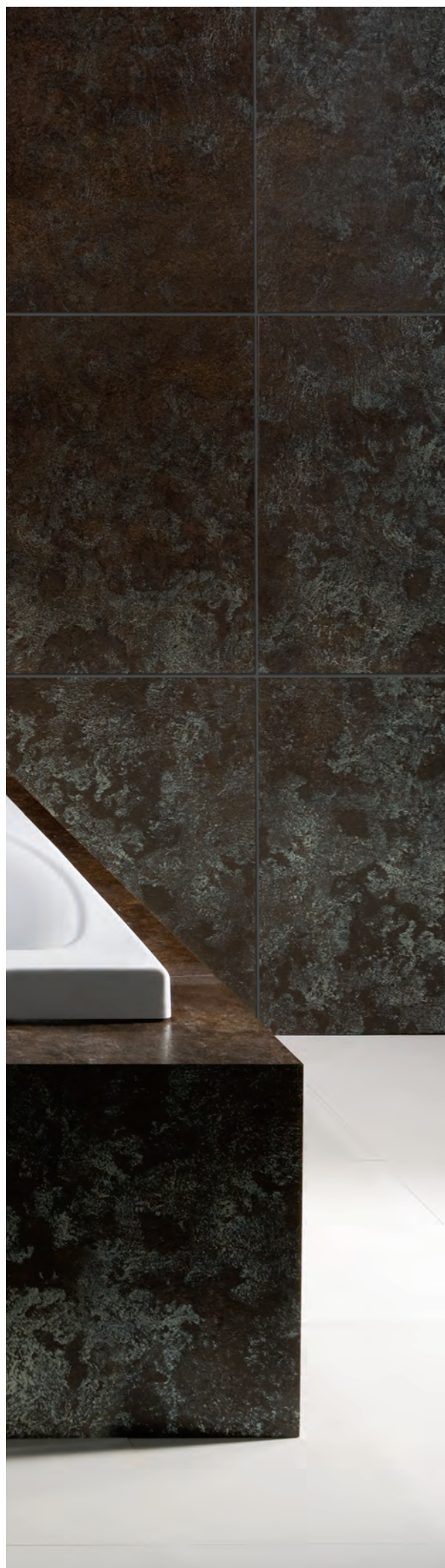

Straight Baths



CELSIUS 1700



Shower

Whirl Pool

Head Rest

Filler Overflow & Clicker Waste
FREE
with Bath

A shower valve or side valves are required to operate the overflow/filler option

Available in two width options, the 700 and 750 create a bathroom design with sleek, sharp lines. Either of these options are suitable for the smaller bathroom.

1700 x 700 x 430mm 265 litres

Description	Code	£ Ex VAT	£ Inc VAT
1700 x 700 bath RH*	57.0031R	701.00	841.20
1700 x 700 bath LH*	57.0031L	701.00	841.20

PANELS

1700 front panel	57.1041	156.00	187.20
700 x 1700 L panel	57.1051	276.00	331.20
HR900 headrest	23.309	106.00	127.20

1700 x 750 x 430mm 275 litres

Description	Code	£ Ex VAT	£ Inc VAT
1700 x 750 bath RH*	57.0041R	828.00	993.60
1700 x 750 bath LH*	57.0041L	828.00	993.60

PANELS

1700 front panel	57.1041	156.00	187.20
700 x 1700 L panel	57.1061	276.00	331.20
HR900 headrest	23.309	106.00	127.20

*These baths now come with a free filler, overflow and clicker waste. NB: Celsius bath filler requires minimum pressure of 1.5 bar. A shower valve or side valves are required to operate the overflow/filler option, see pages 574-577.

FEATURES

- Rectangular clicker waste
- Stocked Carronite 6 jet c lenda whirlpool available, page 157
- Concealed overflow/filler option (WRAS certified)
- Suitable for showering
- Optional headrest available
- Carronite baths have a 30 year guarantee
- Bespoke whirlpool available

Welcome to the future of bath design

Celsius is the most forward thinking development to be seen in the bath industry for many years. With bold, cutting edge design concepts, the Celsius range of baths feature original technology advancements. The options for this bath include:

- a concealed and combined overflow/filler option (WRAS certified)
- a rectangular, clicker waste
- a smooth, one-piece panel design.

The sleek, sharp lines of the Celsius baths complement the latest market developments in ceramics and brassware.

Celsius is brought to you by Carron Bathrooms, a company with a 250 year heritage in design and manufacturing excellence. All products are designed and manufactured from Carron's base in Falkirk, Scotland. All Celsius baths are manufactured in Carron's unique, patented Carronite™ specification.

Celsius - simply the Art of Bath Design.



Celsius 700

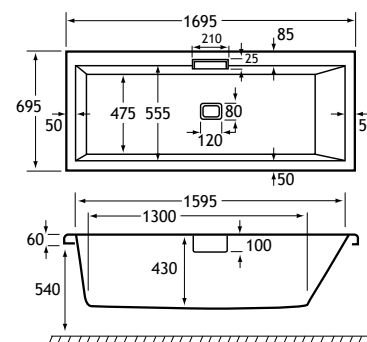

Celsius 750

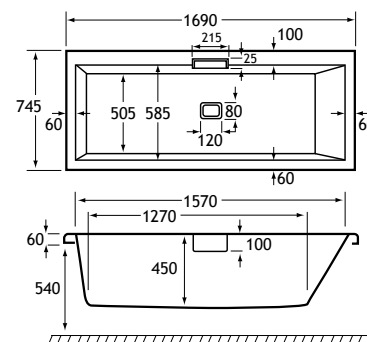

Straight Baths

CELSIUS 1800

Minimalism redefined

A modern, contemporary design which takes minimalism to new levels. This is the ideal choice to achieve a clean, clutter free look in the bathroom.

The Celsius 1800, 1700 x 700/750 and showerbath options feature a combined and concealed overflow/filler option. The rectangular clicker waste is a standard feature on the rectangular models.

All Celsius baths are manufactured in Carronite™- Carron's patented manufacturing process. Comprehensive tests demonstrate that Carronite™ baths:

- Are twice as strong as standard acrylic baths.
- Ensure water retains heat for far longer than in a cast iron or steel bath.
- Have a unique cradle support system; this has been designed to cope with the additional weight of the Carronite™ material. Once installed, the bath's stability and rigidity prevent movement thus offering the perfect solution to the problem of sealing.
- Are 25% more slip resistant than a cast iron or enamelled steel bath.

These results are the reason that:

- More industry professionals would recommend a Carronite™ bath over any other currently available.
- We have confidence in the lifetime of the product to offer a 30 year manufacturer's warranty.



A shower valve or side valves are required to operate the overflow/filler option

A very practical option when replacing old imperial baths. Features full length textured base.

1800 x 800 x 450mm		300 litres	
Description	Code	£ Ex VAT	£ Inc VAT
1800 x 800 bath*	57.0011	1088.00	1305.60

PANELS			
Description	Code	£ Ex VAT	£ Inc VAT
1800 front panel	57.1011	171.00	205.20
1800 L panel	57.1021	276.00	331.20
HR900 headrest	23.309	106.00	127.20

* These baths now come with a free filler, overflow and clicker waste. NB: Celsius bath filler requires minimum pressure of 1.5 bar. A shower valve or side valves are required to operate the overflow/filler option, see pages 574-578.

FEATURES

- Rectangular clicker waste
- Stocked Carronite 6 jet c lenda whirlpool available, page 157
- Concealed overflow/filler option (WRAS certified)
- Suitable for showering
- Optional headrest available
- Carronite baths have a 30 year guarantee
- Bespoke whirlpool available



Head-rests available for all baths



Description	Code	£ Ex VAT	£ Inc VAT
Universal Foam Headrest	84.0001	28.00	33.60
Universal PU Gel Headrest	84.0000	55.00	66.00

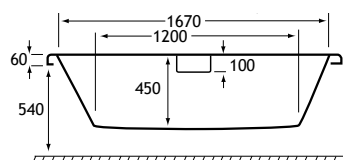
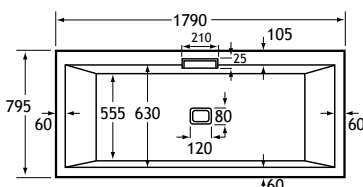

Shower Baths

CELSIUS SHOWERBATH



Urban Showerbath Screen 23.625
Height 1400mm

Modern practicality

Combining the practicality of a shower with bathing without compromise on the modern design ethos of Celsius.

1700 x 750-900 x 450mm		305 litres	
Description	Code	£ Ex VAT	£ Inc VAT
1700 x 900 RH*	57.0051R	1029.00	1234.80
1700 x 900 LH*	57.0051L	1029.00	1234.80

PANELS			
Front panel	57.1071	304.00	364.80
L panel	57.1081	416.00	499.20
Wrap around screen	57.6000	619.00	742.80
Urban screen	23.625	202.00	242.40
HR900 headrest	23.309	106.00	127.20

* These baths now come with a free filler, overflow and clicker waste. NB: Celsius bath filler requires minimum pressure of 1.5 bar. A shower valve or side valves are required to operate the overflow/filler option, see pages 574-578.

FEATURES

- Round clicker waste
- Concealed overflow/filler (WRAS certified)
- Ideal for showering
- Optional headrest available
- Carronite baths have a 30 year guarantee
- Bespoke whirlpool available
- Stocked Carronite 6 jet c lenda whirlpool available, page 143

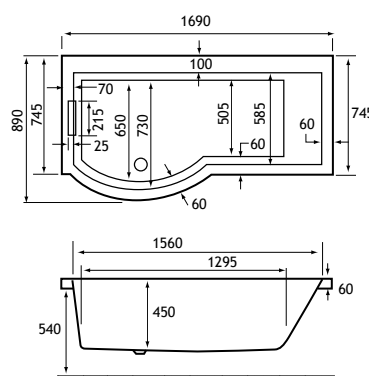

Head-rests available for all baths



Description	Code	£ Ex VAT	£ Inc VAT
Universal Foam Headrest	84.0001	28.00	33.60
Universal PU Gel Headrest	84.0000	55.00	66.00

CELSIUS DUO



Bringing luxury into your home

Fabulous as a centrepiece in a large bathroom. The luxurious depth and width of the Celsius Duo comfortably accommodates two bathers or is the ultimate bathing experience on your own. For built-in application only.

2000 x 1400 x 480mm		560 litres	
Description	Code	£ Ex VAT	£ Inc VAT
Celsius 2000 x 1400 duo bath	57.0061	2811.00	3373.20
Long reach pop-up waste	23.7111	94.00	112.80
HR900 Headrest	23.309	106.00	127.20

FEATURES

- Carronite baths have a 30 year guarantee
- Bespoke whirlpool available
- Optional headrest available



Whirlpool Options

Description	Code	£ Ex VAT	£ Inc VAT
C-Lenda System 2 Whirlpool Duo	14.036	2240.00	2688.00
C-Lenda System 3 Whirlpool Duo	14.037	2452.00	2942.40
C-Lenda System 5 Whirlpool Duo	14.038	2452.00	2942.40
C-Lenda System 6 Whirlpool Duo	14.039	2707.00	3248.40

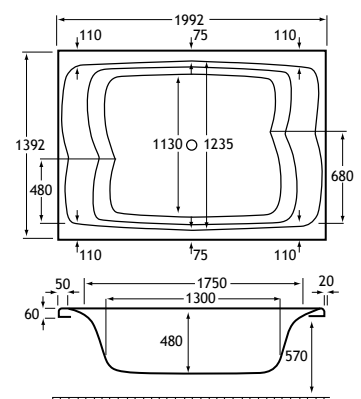

CELSIUS OVAL



Whirl Pool 

Head Rest 

Sumptuous depth

As a feature of the larger bathroom, the Celsius Oval looks stunning fully built-in or semi-inset with panel, as shown. With its sumptuous depth sinking into this bath is the perfect way to relax.

1900 x 1000 x 470mm **320 litres**

Description	Code	£ Ex VAT	£ Inc VAT
Celsius 1900 x 1000 oval bath	57.0021	1360.00	1632.00
Celsius oval panel	57.1031	478.00	573.60

* NB. Half panel installation only.

FEATURES

- Carronite baths have a 30 year guarantee
- Bespoke whirlpool available

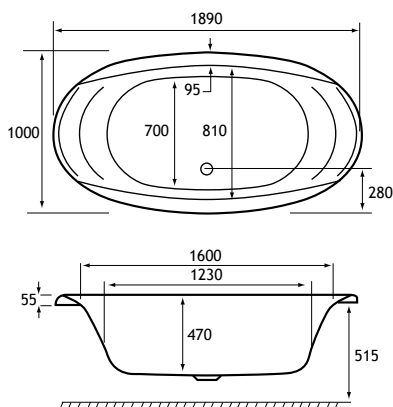

Head-rests available for all baths



Description	Code	£ Ex VAT	£ Inc VAT
Universal Foam Headrest	84.0001	28.00	33.60
Universal PU Gel Headrest	84.0000	55.00	66.00

CELSIUS FREESTANDING



Simply stunning

A stunning focal point in the larger bathroom. Supplied with a free flow filler, it will require a valve to operate the filler.

1900 x 910 x 450mm	330 Litres
Description	Code £ Ex VAT £ Inc VAT
1900 x 910 freestanding bath	57.0001 1929.00 2314.80

FEATURES

- WRAS certified free flow filler
- Carronite baths have a 30 year guarantee

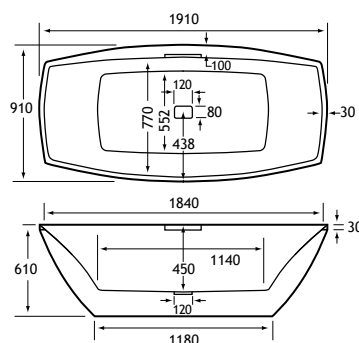

C-lenda

FLUSH-JET TECHNOLOGY



Fully fitted
with flush-jet
technology by

FLUSH-JET TECHNOLOGY

The latest innovation in spa baths

Born of 20 years endless pursuit of design excellence, MARKON have developed the new generation of c-lenda spa bath fittings.

Superior design, sophisticated style - this worldwide patented system combines modern materials with the look of tomorrow's technology, offering the bather the comfort and style they deserve.

With MARKON's patented c-lenda technology, fittings are mounted flush with the bath wall, creating a smooth continuous surface without any protrusions. Designed to be visually pleasing and extremely comfortable, the c-lenda fittings are easy to clean and will maintain their appealing look for years to come.

Every aspect of c-lenda technology has been designed with the bather in mind. From the smooth, easily adjustable controls, the invigorating jet massage performance through to the super safe suction system, you can be assured you will get the comfort, style, performance and protection you deserve from c-lenda.

c-lenda, "there will be no looking back"

INNOVATIVE THINKING

MARKON constantly focuses energy on changing needs and have designed and developed technological advancements in water jets for the spa bath (whirlpool) markets. Our philosophy is to lead the world in design and development of new products for these markets through innovation, total quality management and supreme service levels.

We are committed to designing and developing high quality products and incorporate an extensive research and development strategy to keep us in the forefront of the industry.

Our strength is our ability to control the total process of design, development and manufacture which allows us to maintain the highest product standards with seamless integration.

PATENTED DESIGN TECHNOLOGY

The intelligence of the c-lenda flush jet system lies within the patented mounting flange. Manufactured from high grade stainless steel this unique patented load transfer device ensures the fittings are securely mounted to eliminate cracking and peeling, which prolongs the quality and beauty of your c-lenda flush jet system.

Anything else is a compromise.



C-lenda

Celsius c-lenda is stocked for immediate delivery in System 1 only, other options available as special order, see pages 168-171.



FLUSH SUCTION

Designed with total safety in mind, this suction has a unique built in safety feature which disengages the water pressure within seconds of being activated.

FEATURES

- Fast acting safety protection for hair and body entrapment
- Stainless steel surround
- Removable by key for easy cleaning

System 1 featured on these pages comes with six flush centro side jets, pneumatic controls and flush suction.

Celsius 1700 x 700/750, 1800, Showerbath and Oval are compatible with all c-lenda systems.

See page 165 for prices.

FLUSH CENTRO JET

A high performance, mid sized hydro body jet

FEATURES

- Adjustable finger tip directional control
- High air to water mix ration
- Removable for easy cleaning
- Stainless steel surround.

CELSIUS C-LEND A 700 & 750 SYSTEM 1

Celsius 1700

Available in two width options, the 700 and 750 create a bathroom design with sleek, sharp lines. Either of these options are suitable for the smaller bathroom.

Description	Code	£ Ex VAT	£ Inc VAT
1700 x 700 C-lenda bath RH*	19.200R	1747.00	2096.40
1700 x 700 C-lenda bath LH*	19.200L	1747.00	2096.40
1700 x 750 c-lenda bath RH*	19.201R	1874.00	2248.80
1700 x 750 c-lenda bath LH*	19.201L	1874.00	2248.80

PANELS

Description	Code	£ Ex VAT	£ Inc VAT
1700 front panel	57.1041	156.00	187.20
700 x 1700 L panel	57.1051	276.00	331.20
1700 x 750 L panel	57.1061	276.00	331.20
HR900 Headrest	23.309	106.00	127.20

* These baths now come with a free filler, overflow and clicker waste. NB: Celsius bath filler requires minimum pressure of 1.5 bar. A shower valve or side valves are required to operate the overflow/filler. Celsius baths also available with all other c-lenda systems as a special order, see pages 164 - 165.

FEATURES

- Concealed overflow/filler option (WRAS certified)
- Rectangular clicker waste
- Optional headrest available



The Celsius 1700 x 700 and 1700 x 750 feature a combined and concealed overflow/filler option. The rectangular clicker waste is a standard feature on the rectangular models.

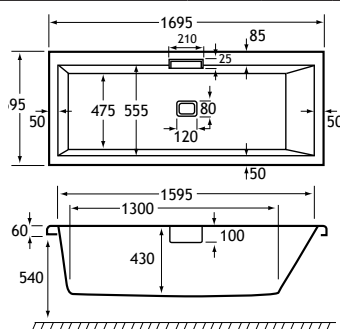

1700 x 700

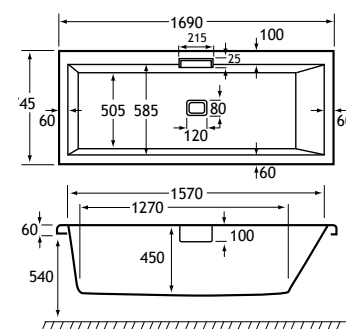

1700 x 750

CELSIUS C-LEND A SHOWERBATH



Filler Overflow & Clicker Waste
FREE
with Bath

Modern practicality

Combining the practicality of a shower with bathing without compromise on the modern design ethos of Celsius.

1700 x 900-750 x 450mm		305 Litres	
Description	Code	£ Ex VAT	£ Inc VAT
1700 x 900 RH c-lenda*	19.203R	2075.00	2490.00
1700 x 900 LH c-lenda*	19.203L	2075.00	2490.00

PANELS

Description	Code	£ Ex VAT	£ Inc VAT
Front panel	57.1071	304.00	364.80
L panel	57.1081	416.00	499.20
Wrap around Screen	57.6000	619.00	742.80
Urban Shower Screen	23.625	202.00	242.40

* These baths now come with a free filler, overflow and clicker waste. NB: Celsius bath filler requires minimum pressure of 1.5 bar.

Celsius baths also available with all other c-lenda systems as a special order, see pages 164 - 165.

The Celsius showerbath features a combined and concealed overflow/filler option. The rectangular clicker waste is a standard feature on the rectangular models.

Head-rests available for all baths



Description	Code	£ Ex VAT	£ Inc VAT
Universal Foam Headrest	84.0001	28.00	33.60
Universal PU Gel Headrest	84.0000	55.00	66.00

System 1 featured on this page comes with six flush centro side jets, pneumatic controls and flush suction.

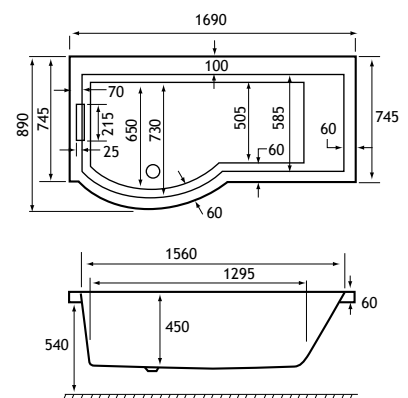

1700 x 900

CELSIUS 1800



Minimalism redefined

A modern, contemporary design which takes minimalism to new levels. This is the ideal choice to achieve a clean, clutter-free look in the bathroom.

1800 x 800 x 450mm 300 Litres

Description	Code	£ Ex VAT	£ Inc VAT
1800 x 800 c-lenda bath*	19.202	2134.00	2560.80

PANELS

1800 front panel	57.1011	171.00	205.20
1800 L panel	57.1021	276.00	331.20

* These baths now come with a free filler, overflow and clicker waste. NB: Celsius bath filler requires minimum pressure of 1.5 bar.

Celsius baths also available with all other c-lenda systems as a special order, see pages 164 - 165.

The Celsius 1800 bath features a combined and concealed overflow/filler option. The rectangular clicker waste is a standard feature on the rectangular models.

System 1 featured on this page comes with six flush centre side jets, pneumatic controls and flush suction.

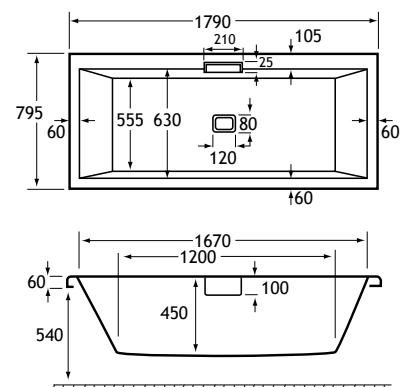



Hydro - Therapy

The new generation of whirlpool baths featuring the latest technological advancements in spa fittings ensuring affordable and luxurious systems.

Contents

Special order c-lenda whirlpools	162 - 165
Whirlpool baths for immediate delivery	166 - 171

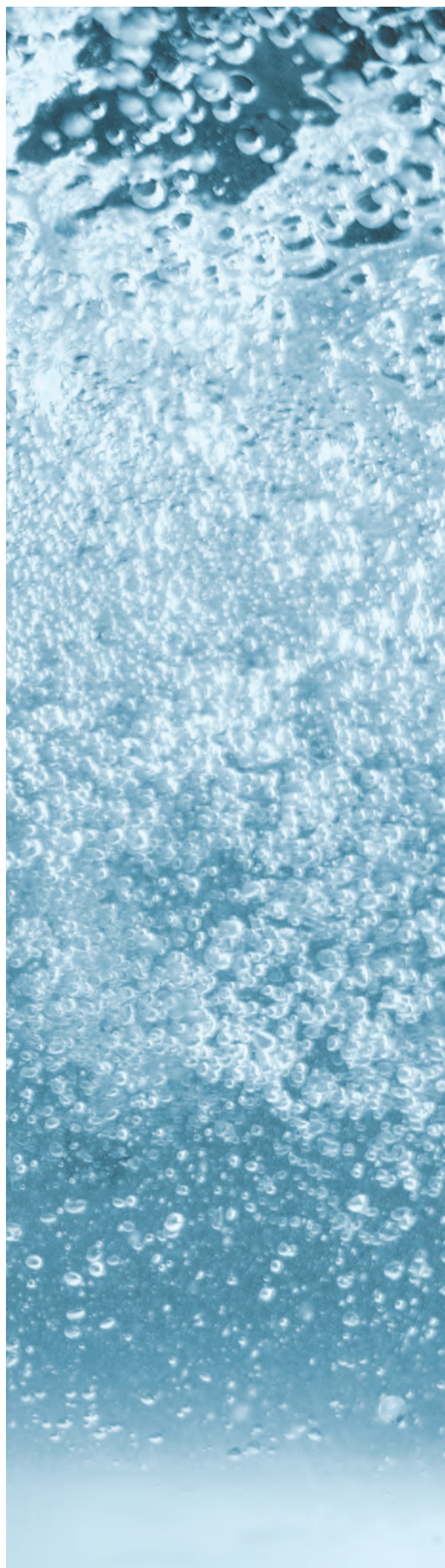

C-lenda Whirlpools

Anything else is a compromise.

“After a c-lenda, there is no looking back.”



The latest innovation in spa baths

Born of 20 years endless pursuit of design excellence, MARKON have developed the new generation of c-lenda spa bath fittings.

Superior design, sophisticated style - this worldwide patented system combines modern materials with the look of tomorrow's technology, offering the bather the comfort and style they deserve.

With MARKON's patented c-lenda technology, fittings are mounted flush with the bath wall, creating a smooth continuous surface without any protrusions. Designed to be visually pleasing and extremely comfortable, the c-lenda fittings are easy to clean and will maintain their appealing look for years to come.

Every aspect of c-lenda technology has been designed with the bather in mind. From the smooth, easily adjustable controls, the invigorating jet massage performance through to the super safe suction system, you can be assured you will get the comfort, style, performance and protection you deserve from c-lenda.

Patented Design Technology

The intelligence of the c-lenda flush jet system lies within the patented mounting flange. Manufactured from high grade stainless steel this unique patented load transfer device ensures the fittings are securely mounted to eliminate cracking and peeling, which prolongs the quality and beauty of your c-lenda flush jet system.

Innovative Thinking

MARKON constantly focuses energy on changing needs and have designed and developed technological advancements in water jets for the spa bath (whirlpool) markets. Our philosophy is to lead the world in design and development of new products for these markets through innovation, total quality management and supreme service levels.

We are committed to designing and developing high quality products and incorporate an extensive research and development strategy to keep us in the forefront of the industry.

Our strength is our ability to control the total process of design, development and manufacture which allows us to maintain the highest product standards with seamless integration.

C-lenda Whirlpools

c-lenda special order system

Only 1mm protrusion from bath. Controls now on the inside vertical of the bath leaving the bath ledge clutter-free.

Flush Suction



Designed with total safety in mind, this suction has a unique built in safety feature which disengages the water pressure within seconds of being activated.

FEATURES

- Fast acting safety protection for hair and body entrapment
- Stainless steel surround
- Removable by key for easy cleaning

Flush Mini Jet



Mini jet clusters are designed to deliver a concentrated hydromassage to muscle groups including lumbar, feet and shoulders.

FEATURES

- Compact
- Specific directional water flow
- High air to water mix ratio
- Stainless steel surround

Flush Centro Jet



A high performance, mid sized hydro body jet.

FEATURES

- Adjustable finger tip directional control
- High air to water mix ration
- Removable for easy cleaning
- Stainless steel surround

Pages 164-165 detail the six system configurations.

We will also consider any special requirements you may have that are not listed here.

The following bath ranges; Delta, Sigma, Alpha, Haiku, Sigma showerbath and Delta showerbath with all c-lenda systems are usually available in 20 working days (excluding bank holidays) from signed confirmation of order. Other baths shown are available in six weeks. If the bath is not shown please ask our sales team for lead times and compatability with different systems. **Biarritz, Zone - 12 week lead time from signed order confirmation.**

Flush Air Control



Flush Air Button/ Pneumatic Control



The position of the controls and light are for illustration purposes only.

C-lenda Whirlpools

	AIR FLUSH CONTROL	FLUSH SUCTION	PNEUMATIC CONTROL	ELECTRONIC CONTROL	SIX SIDE JETS	SIX BACK JETS	FOUR FEET JETS	CHROMOTHERAPY LIGHT
System 1	✓	✓	✓	-	✓	-	-	-
System 2	✓	✓	✓	-	✓	✓	✓	-
System 3	✓	✓	✓	-	✓	✓	✓	✓
System 4	✓	✓	-	✓	✓	-	-	-
System 5	✓	✓	-	✓	✓	✓	✓	-
System 6	✓	✓	-	✓	✓	✓	✓	✓

	SYSTEM 1	SYSTEM 2	SYSTEM 3	SYSTEM 4	SYSTEM 5	SYSTEM 6
Alpha Range	✓	✓	✓	✓	✓	✓
Arc single ended 1500	✓	-	-	✓	-	-
Arc single ended 1700 x 700/750	✓	✓	✓	✓	✓	✓
Arc 1700 x 750/1800 Duo	✓	✓	✓	✓	✓	✓
Arc Showerbath	✓	-	-	✓	-	-
Biarritz 1800 x 800 5mm ¹	✓	-	-	✓	-	-
Brio 1650 Showerbath 5mm	✓	-	-	✓	-	-
Brittania Classic	✓	-	-	✓	-	-
Celsius 1700/1800	✓	✓	✓	✓	✓	✓
Celsius Duo	See separate table on page 151 on special system					
Celsius Oval/Showerbath	✓	✓	✓	✓	✓	✓
Centennial	✓	✓	✓	✓	✓	✓
Delta Range ²	✓	✓	✓	✓	✓	✓
Delta Showerbaths	✓	-	-	✓	-	-
Dove	✓	-	-	✓	-	-
Echelon 1700/1800 ³	✓	✓	✓	✓	✓	✓
Equation 1700/1800	✓	✓	✓	✓	✓	✓
Equity 1700/1800	✓	✓	✓	✓	✓	✓
Haiku 1700/800/900	✓	✓	✓	✓	✓	✓
Imperial 1400/1500 TG	✓	-	-	✓	-	-
Imperial Range 1600/1700/1800/5'6"	✓	✓	✓	✓	✓	✓

¹ Please check with sales for lead time.

² Delta 1400 plain and TG can only be fitted with system 1 and 4.

³ Only tap ledge version in Echelon available as the tap ledge is required for the controls.

Baths not compatible

Advantage	Britannia Victoria	Rio	Paradigm
Apex	Classic showerbath	Matrix family	Prado 1500
Axis family	Falcon	Napoli	Profile/Profile showerbath
Axis showerbath	Halcyon Family	Neo Classical	Quantum 1500 showerbath
Bali	Ibis	Oriole	Quantum 1600/1700 showerbath
Urban Sitbath	Swallow	Verona	Quantum Integra Eco

C-Lenda Whirlpools

	SYSTEM 1	SYSTEM 2	SYSTEM 3	SYSTEM 4	SYSTEM 5	SYSTEM 6
Linea	✓	✓	✓	✓	✓	✓
Mistral	✓	✓	✓	✓	✓	✓
Monarch	✓	-	-	✓	-	-
Quantum Integra SE 1500/1600/1700x700	✓	-	-	✓	-	-
Quantum Integra SE 1650	✓	-	-	✓	-	-
Quantum Integra SE 1700x750/800/1800	✓	✓	✓	✓	✓	✓
Quantum Integra DE 1700x750	✓	-	-	✓	-	-
Quantum SE 1500x700/1600x700/1700x700	✓	-	-	✓	-	-
Quantum SE 1600x800/1700x750/800/900 1800x725/800	✓	✓	✓	✓	✓	✓
Quantum Duo 1700x700/750	✓	-	-	✓	-	-
Quantum Duo 1700x800/1800/1900	✓	✓	✓	✓	✓	✓
Quantum Spacesaver	✓	-	-	✓	-	-
Sigma Range	✓	✓	✓	✓	✓	✓
Sigma Showerbath	✓	✓	✓	✓	✓	✓
Status 1600/1700x725 ⁴	✓	-	-	✓	-	-
Status 800 ⁴	✓	✓	✓	✓	✓	✓
Status Showerbath ⁴	✓	-	-	✓	-	-
Swan Bath	✓	✓	✓	✓	✓	✓
Swing	✓	✓	✓	✓	✓	✓
Tranquillity ⁵	✓	✓	✓	✓	✓	✓
Urban Edge ⁶	✓	✓	✓	✓	✓	✓
Urban family	✓	✓	✓	✓	✓	✓
Zone Showerbath 1700 x 750 ⁴	✓	-	-	✓	-	-
Zone Showerbath 1800 x 800 ⁴	✓	-	-	✓	-	-

⁴ Please check with sales for lead time.

⁵ Tranquillity has only five body jets instead of six.

⁶ Urban sit bath is not compatible with any system.

Standard Whirlpool System			
Description	Code	£ Ex VAT	£ Inc VAT
C-Lenda System 1	14.030	1046.00	1255.20
C-Lenda System 2	14.031	1305.00	1566.00
C-Lenda System 3	14.032	1575.00	1890.00
C-Lenda System 4	14.033	1305.00	1566.00
C-Lenda System 5	14.034	1575.00	1890.00
C-Lenda System 6	14.035	1834.00	2200.80

Celsius Duo Bath System						
SYSTEM NUMBER	PNEUMATIC CONTROL	ELECTRONIC SUCTION	SIDE JETS	BACK JETS	FEET JETS	CHROMOTHERAPY LIGHT
System 1	✓	-	6	12	8	-
System 2	✓	-	6	12	8	✓
System 3	-	✓	6	12	8	-
System 4	-	✓	6	12	8w	✓

Please note: All prices are for the whirlpool systems only. The bath is priced separately.

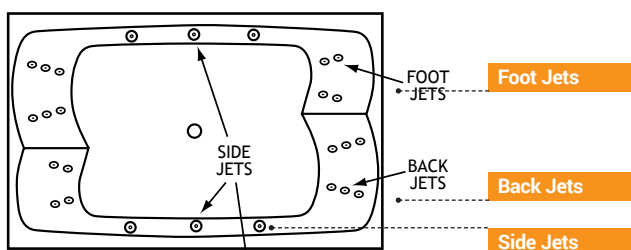

Description	Code	£ Ex VAT	£ Inc VAT
C-Lenda System 2 Whirlpool Duo	14.036	2240.00	2688.00
C-Lenda System 3 Whirlpool Duo	14.037	2452.00	2942.40
C-Lenda System 5 Whirlpool Duo	14.038	2452.00	2942.40
C-Lenda System 6 Whirlpool Duo	14.039	2707.00	3248.40

Whirlpool Baths

Pressure, rushing, deadlines: the natural rhythm of modern life creates unnatural tension and harmful stress. Every minute of our waking day uses our precious energy and saps our strength.

We offer a range of affordable and luxurious systems to revive your energy and explore new ways to relax. All this especially for you, because we know that you will appreciate the quality of the product long after you have asked the price. Affordable and luxurious hydro systems.

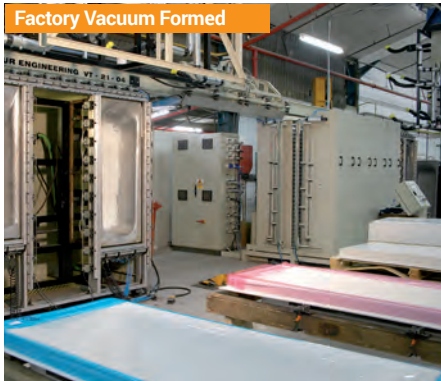

Factory Vacuum Formed



Factory Reinforced



Hand Finished



Factory Trimmed



Factory Drilled



Factory Installed



Factory Tested



Factory Checked



Factory Packed

Whirlpool Baths

Hydrotherapy is the therapeutic effects you experience when you are immersed in hot water. The heat that is transferred from the warm water to your body combines with the buoyant effect of the water to trigger physiological changes in the body. But, when you immerse yourself in a normal bath, the body's natural reaction counteracts with the therapeutic value that warm water can induce and the majority of the therapeutic effects of hydrotherapy are lost.

The fine layer of air that surrounds the body when you first immerse yourself in water quickly cools to body temperature and prevents the transfer of heat. Your pores close, preventing perspiration, and the increase in blood flow simply leads to an overall increase in body temperature.

A whirlpool jet (water pumped at force directly onto the body) eradicates this effect. Heat is immediately transferred to the body. The constant agitation of the warm water against the skin encourages blood vessels and capillaries to open, sending a higher volume of oxygen-rich blood to the extremities. The heat transfer has a sedative effect on the nerve endings, reducing pain and discomfort.

The massaging effect of the jets has further benefits: they reduce oedema (fluid swelling) around the joints. Also the pressure stimulates the receptors in the nerve endings and distracts the pain-carrying nerves from passing their pain-inflicting messages to the brain. Pain-killing endorphins are released and the body responds with a sense of well-being.

Research in the USA by the Arthritis Foundation and the Bristol Royal Infirmary in the UK reveals that the ancient art of hydrotherapy with the aid of jetted water has several medical benefits:

- It dilates the arteries, increasing blood circulation without increasing heart rate and therefore lowering blood pressure.
- Cardiovascular changes relieve congestive heart failure, hypertension and stress.
- Hymodilation dilutes the blood, reducing inflammation and swelling due to arthritic problems. It also relieves muscular aches and pains and increases the tissue repair system.
- Increased diuresis (water and salt loss) helps gout, kidney disorders and cirrhosis.

TECHNICAL

1. On/Off Switch
2. Air Control
3. Centro Jets
4. Back Mini Jets
5. Bath Pump
6. Suction Pipe
7. Foot Mini Jet
8. Chromotherapy Light and Control

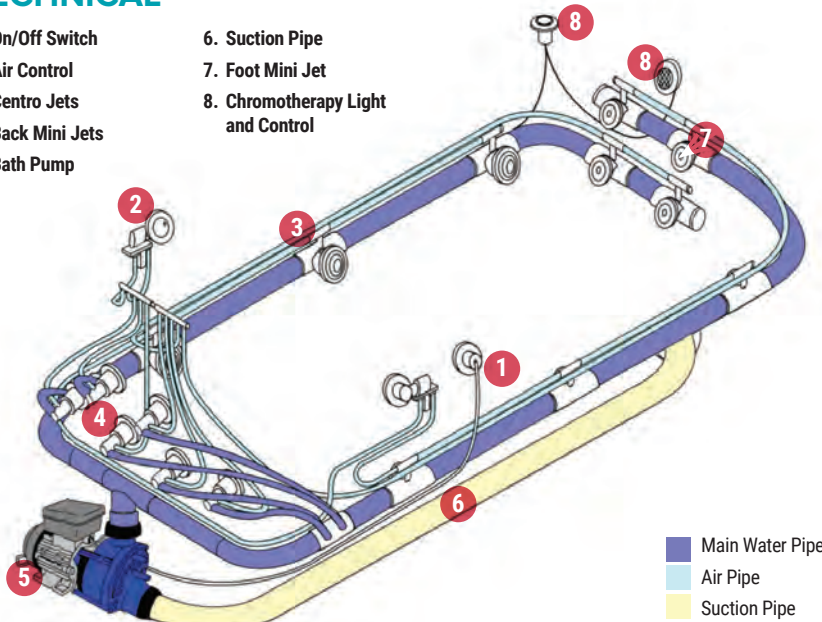

Whirlpool Warranty

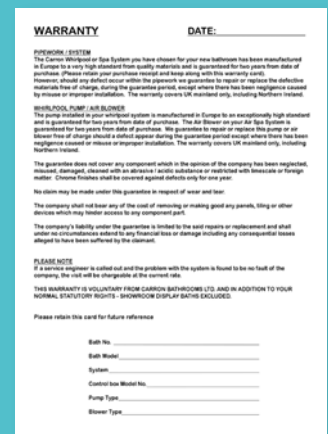

TECHNICAL CONTINUED

Rigid piping, 0.75hp self draining pump, fixed and mounted, pneumatic on/off control, directional whirlpool jets, fitted and fully tested, complete with two-year warranty. All systems use 13 amp supply with ELCB fitted by a qualified electrician.

Note: because pipes are housed within the vertical of the outside rim of the bath this means that a wooden panel will not fit.

Stocked whirlpools for immediate delivery now available with flush c-lenda jets.

Only 1mm protrusion from bath. Controls now on the inside vertical of the bath leaving the bath ledge clutter-free.

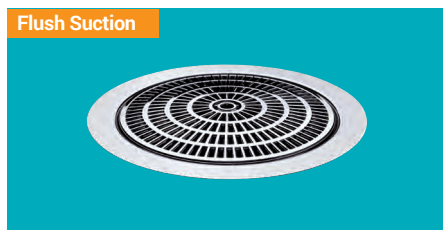

Flush Suction

Designed with total safety in mind, this suction has a unique built in safety feature which disengages the water pressure within seconds of being activated.

FEATURES

- Fast acting safety protection for hair and body entrapment
- Stainless steel surround
- Removable by key for easy cleaning

Flush Centro Jet

A high performance, mid sized hydro body jet.

FEATURES

- Adjustable finger tip directional control
- High air to water mix ratio
- Removable for easy cleaning
- Stainless steel surround

Whirlpool Baths

IMPERIAL 1700



Grips 

Head Rest 

This best-selling bath with traditional finish and grips now available in standard length. Features full length textured base.

1700 x 700 x 400mm		180 litres	
Description	Code	£ Ex VAT	£ Inc VAT
Imperial 1700 Carronite c-lenda w/pool sys 1	19.147	1268.00	1521.60
Headrest HR800	23.312	106.00	127.20

* For more detailed information on the Imperial's dimensions please refer to page 63.

EQUATION 1700X750 / 1800X800



Head Rest 

A spacious double ended bath with a large central tap ledge to allow for all modern combinations of taps.

1700 x 750 x 420mm		205 litres	
1700 x 792 x 430mm		233 litres	
Description	Code	£ Ex VAT	£ Inc VAT
Equation 1700x 750 Carronite c-lenda w/pool sys 1	19.132	1411.00	1693.20
Equation 1800 x 800 Carronite c-lenda w/pool sys 1	19.134	1506.00	1807.20

* For more detailed information on the Equation's dimensions please refer to pages 70 and 86.

Description	Code	£ Ex VAT	£ Inc VAT
Equation 1700x750 Carronite c-lenda w/pool sys 6	19.152	2199.00	2638.80
Equation 1800x800 Carronite c-lenda w/pool sys 6	19.154	2294.00	2752.80

SYSTEM 6 FEATURES

- 30 year Carronite guarantee
- Individually crated for safe transportation
- Six side jets
- Six back jets
- Four feet jets
- Chromotherapy light
- No tap holes or waste fittings

BRITANNIA CLASSIC 1700 SUPER DEEP



Head Rest 

Exclusive to Eastbrook, this bath was produced as a result of public demand. It offers an amazing bathing area in terms of both depth and width, therefore it is ideally suited for c-lenda hydrotherapy.

1700 x 750 x 460mm		210 litres	
Description	Code	£ Ex VAT	£ Inc VAT
Brit classic 1700x750 Carronite c-lenda w/p sys1	19.148	1472.00	1766.40

* For more detailed information on the Britannia Classic's dimensions please refer to page 75.

Whirlpool Baths

STATUS 1700

Head Rest 



Bringing a unique perspective to bathroom design the Status adds a touch of luxury with its soft curves and ideal proportions.

1700 x 800 x 450mm		250 litres	
Description	Code	£ Ex VAT	£ Inc VAT
Status 1700 x 800 LH Carronite c-lenda w/pool sys1	19.138L	1547.00	1856.40
Status 1700 x 800 RH Carronite c-lenda w/pool sys1	19.138R	1547.00	1856.40

* For more detailed information on the Status' dimensions please refer to page 83. This bath has a suspended panel.

FEATURES

- 30 year Carronite guarantee
- Individually crated for safe transportation
- No tap holes or waste fittings

QUANTUM SE 1700X750

Shower 

Head Rest 



A new design single ended bath with straight sides and minimalist lines maximising both bath and showering space. For gripped version see page 67.

1700 x 750 x 430mm		240 litres	
Description	Code	£ Ex VAT	£ Inc VAT
Quantum SE 1700 x 750 Carronite C-lenda System 1	19.155	1329.00	1594.80
HR900 Headrest	23.309	106.00	127.20

* For more detailed information on the Quantum's dimensions please refer to page 78.

QUANTUM DUO 1700X750

Head Rest 



A modern and minimalist version of a double ended bath. The straight sides and sloping backs give a spacious bathing area. It has a central waste and overflow below the tap ledge and is suitable for a bath screen.

1700 x 750 x 430mm		190 litres	
Description	Code	£ Ex VAT	£ Inc VAT
Quantum Duo 1700 x 750 Carronite C-lenda System 1	19.156	1329.00	1594.80
HR900 Headrest	23.309	106.00	127.20

* For more detailed information on the Quantum's dimensions please refer to page 78.

FEATURES

- 30 year Carronite guarantee
- Individually crated for safe transportation
- No tap holes or waste fittings

Head-rests available for all baths



Description	Code	£ Ex VAT	£ Inc VAT
Universal Foam Headrest	84.0001	28.00	33.60
Universal PU Gel Headrest	84.0000	55.00	66.00

Whirlpool Baths

ALBANY & ALPHA



Head Rest 



Now available with c-lenda jets.

Albany	1700mm x 700mm
Alpha	1700mm x 750mm
Alpha	1800mm x 800mm

Description	Code	£ Ex VAT	£ Inc VAT
Albany 1700 x 700 Carronite c-lenda w/pool sys 1	19.140	1352.00	1622.40
Alpha 1700 x 750 Carronite c-lenda w/pool sys 1	19.141	1414.00	1696.80
Alpha 1800 x 800 Carronite c-lenda w/pool sys 1	19.142	1535.00	1842.00
Headrest HR800	23.312	106.00	127.20

* For more detailed information on the Albany's dimensions please refer to page 60.
For more detailed information on the Alpha's dimensions please refer to page 74 and 89.

FEATURES

- 30 year Carronite guarantee
- Individually crated for safe transportation
- Optional headrest available
- No tap holes or waste fittings

Stocked whirlpools for immediate delivery

DELTA & SIGMA



Shower 

Head Rest 

Delta	1700mm x 700mm		
Sigma	1700mm x 750mm		
Sigma	1800mm x 800mm		
Description	Code	£ Ex VAT	£ Inc VAT
Delta 1700 x 700 Carronite c-lenda w/pool sys 1	19.131	1337.00	1604.40
Sigma 1700 x 750 Carronite c-lenda w/pool sys 1	19.133	1434.00	1720.80
Sigma 1800 x 800 Carronite c-lenda w/pool sys 1	19.135	1560.00	1872.00
Headrest HR800	23.312	106.00	127.20

* For more detailed information on the Delta's dimensions please refer to page 62
For more detailed information on the Sigma's dimensions please refer to page 79 and 93.

Whirlpool Baths



MONARCH

Description	Code	£ Ex VAT	£ Inc VAT
Monarch Corner Carronite c-lenda w/pool sys 1	19.137	1717.00	2060.40
Affinity 1300 panel	23.1841	150.00	180.00
1300 Carronite panel	23.1681	285.00	342.00

FEATURES

- 30 year Carronite guarantee
- Individually crated for safe transportation
- No tap holes or waste fittings



VOLENTE 1000 & 1250 SCREEN



A universal screen which will fit a corner, offset corner or straight bath. It has a wiper seal on the bottom and the folding section is operated by an inter-linking cog assembly.

Description	Code	£ Ex VAT	£ Inc VAT
Volente 1000 4 fold screen	58.700	131.00	157.20
Volente 1250 5 fold screen	58.701	162.00	194.40

FEATURES

- Easy clean glass
- 5mm tempered glass

DELTA 1700

- Shower
- Head Rest



Description	Code	£ Ex VAT	£ Inc VAT
Delta 1700 LH Carronite c-lenda w/p sys1	19.144L	1521.00	1825.20
Delta 1700 RH Carronite c-lenda w/p sys1	19.144R	1521.00	1825.20

PANELS

1700 front panel 5mm	23.1911	136.00	163.20
1700 front panel Carronite	23.1701	278.00	333.60
End panel Carronite	23.1821	121.00	145.20
End panel 5mm	23.1041	89.00	106.80
Headrest HR800 - Black	23.312	106.00	127.20

* This bath has a suspended panel. For matching shower screens see page 117.



Sanitaryware

From the timeless, traditional classic designs to the latest contemporary and minimalist styling, you are sure to find the right suite to fit your décor and budget.

Contents

Andelle	174	Metro	214-217
Anjou	175	Minima	218-219
Arkitekt	176	Mentmore	220-221
Belgravia	177	Northall	222-223
Bijou	178-179	Pluton	224-225
Cheverney	180-181	Quadro	226
Cheltenham	182	Quba	227
Colorado	183	Tamarind	228-229
Collindale	184-185	Temptation	230-231
Courchevel	186 -1 87	Ultima	232-233
Crowthorne	188-189	Wingrave	234-235
DOC M pack	190-191	Sit-On Basins	236
Dura	192-193	Cloakroom Basins	237-239
Elysée	194-195	Vanity Basins	240
Farringdon	196-197	Semi-Recessed Basins	241
Kompact	198-201	Back To Wall Pans	242-243
Linea	202-203	Wall Hung Pans	244
Lisbon II	204-207	Concealed Cisterns	246
Loire	208-211	Sanitaryware Accessories	247
Maestro	212-213		



Andelle Range

ANDELLE

A value for money modern suite with clean lines.

FEATURES

- Cloakroom basin on full pedestal
- Soil can be turned left or right
- Top fix seat
- Soft close seat can be unclipped for cleaning

Description	Code	£ Ex VAT	£ Inc VAT
Fabiano Mirror 700 x 500 LED	40.1004	242.00	290.40



Soft Close Seat

Shown with Genoa Accessories

For full range see page 304



24.0007
24.0011
24.0006

Description	Code	£ Ex VAT	£ Inc VAT
Andelle WC Pan	24.0006	80.00	96.00
Andelle WC Cistern inc Fittings	24.0007	60.00	72.00
Andelle soft close seat	24.0011	46.00	55.20
Jollytronic universal bottom entry cistern fitting	7.0000	99.00	118.80

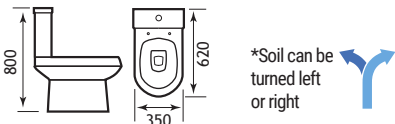

24.0006 24.0007



24.0010
24.0009

Description	Code	£ Ex VAT	£ Inc VAT
Andelle 430mm 1TH Basin	24.0010	45.00	54.00
Andelle Pedestal	24.0009	23.00	27.60

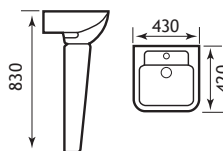

24.0010 24.0009



24.0008
24.0009

Description	Code	£ Ex VAT	£ Inc VAT
Andelle 540mm 1TH Basin	24.0008	49.00	58.80
Andelle Pedestal	24.0009	23.00	27.60

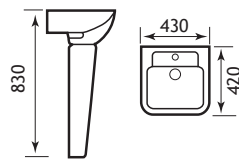

24.0008 24.0009

Anjou Range

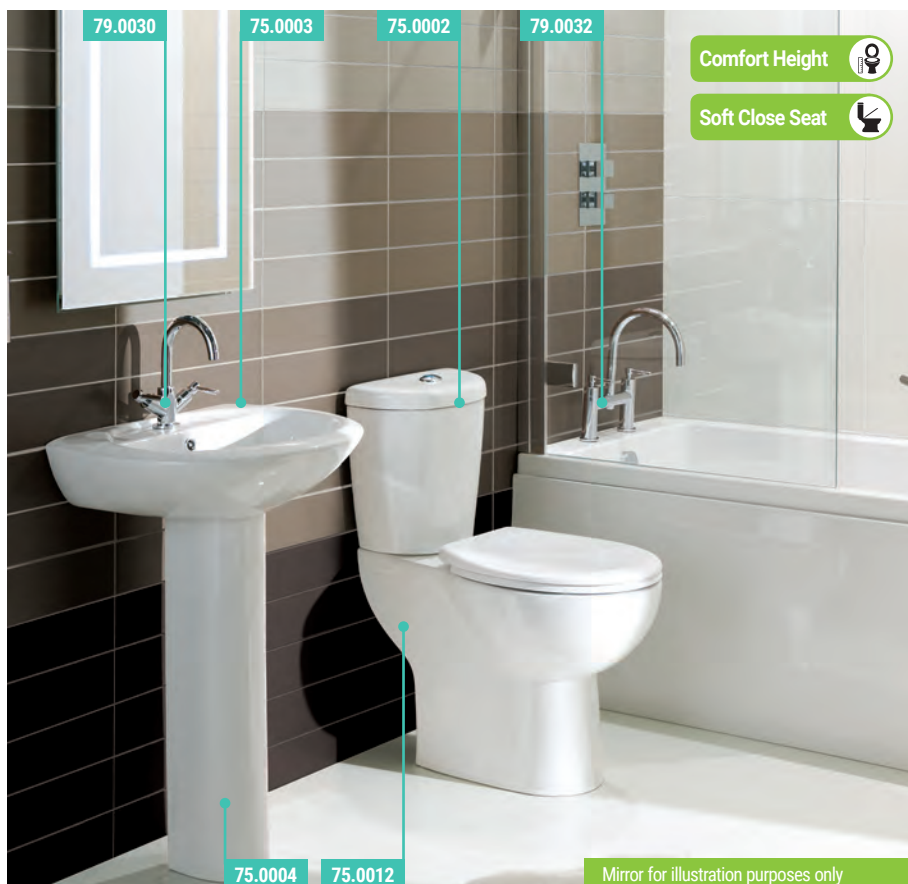

ANJOU HIGH LEVEL PAN

A high-level suite fashioned in a simple, modern design, Anjou is a practical adaptation of our most successful range.

FEATURES

- Soft close seat, lifts off for easy cleaning
- Comfortable high level pan
- Top fix seat (Rhone seat only)
- Soil can be turned left or right



Loire Basin & Tall Cistern Unit

Description	Code	£ Ex VAT	£ Inc VAT
Loire 535 basin 1TH	75.0003	50.00	60.00
Loire 535 basin 2TH	75.0014	50.00	60.00
Loire 450 basin 1TH	75.0005	49.00	58.80
Loire 450 basin 2TH	75.0015	49.00	58.80
Loire pedestal	75.0004	35.00	42.00
Loire Semi Ped for 75.0003 & 75.0014	75.0025	33.00	39.60
Oslo tall cistern unit †	1.278	273.00	327.60
Oslo tall cistern unit top	1.279	40.00	48.00
Oslo tall unit cupboard 500x800x220mm	1.280	184.00	220.80
Oslo tall unit cupboard 500x1000x220mm	1.281	210.00	252.00

Anjou High Level

Description	Code	£ Ex VAT	£ Inc VAT
Anjou High Level pan **	75.0012	243.00	291.60
Loire/Anjou close coupled cistern inc fittings	75.0002	70.00	84.00
Anjou High Level BTW pan	75.0013	270.00	324.00
Loire soft close seat	50.002	96.00	115.20
Rhone soft close seat	40.0001	57.00	68.40
Jollytronic universal bottom entry cistern fitting †	7.0000	99.00	118.80

**Soil can be turned left or right at back of pan.

†For more information see pages 245. † Top only required if cupboard not used.

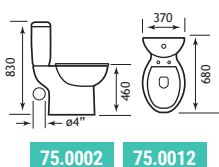
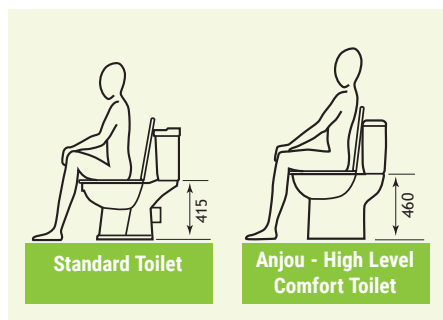

75.0002 75.0012

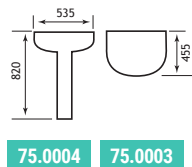

75.0004 75.0003

75.0014

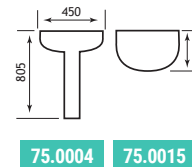

75.0004 75.0015

75.0005

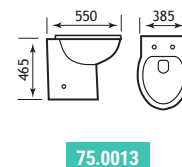

75.0013

Arkitekt Range

ARKITECT

Mirror for illustration purposes only



Shown with Bonito Furniture.

For full range of Bonito furniture see page 314-318

Perfect for the smaller bathroom or cloakroom, the Arkitekt range combines style with space-saving practicality.

Description	Code	£ Ex VAT	£ Inc VAT
Arkitekt BTW WC pan	10.017	111.00	133.20
Loire/Arkitekt deluxe seat	50.001	34.00	40.80
Loire soft close seat	50.002	96.00	115.20

Can be fitted with a Sherwood seat.
For units see page 314-318.

BTW Pan extras

Description	Code	£ Ex VAT	£ Inc VAT
Vantage Plain Hidden Cistern	17.001	133.00	159.60
Vantage Hidden Cistern with Jacket	17.3029	155.00	186.00
EB Jacket Hidden Cistern - Bottom Inlet	53.001	82.00	98.40
Flexible WC Connector for BTW Pans *	2.009	29.00	34.80

*Pan connector 2.009 is recommended for use with our BTW pans.

Smi Recessed Basin

Description	Code	£ Ex VAT	£ Inc VAT
Arkitekt semi-recessed vanity basin 1TH	10.018	102.00	122.40

FEATURES

- Soft close seat, lifts off for easy cleaning

FEATURES - VANTAGE CISTERN

- WRAS approved flushing components
- Delay fill inlet valve - no water waste

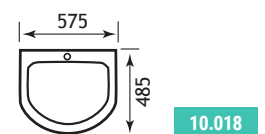
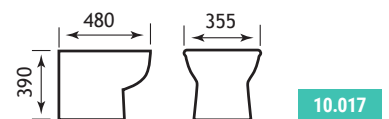
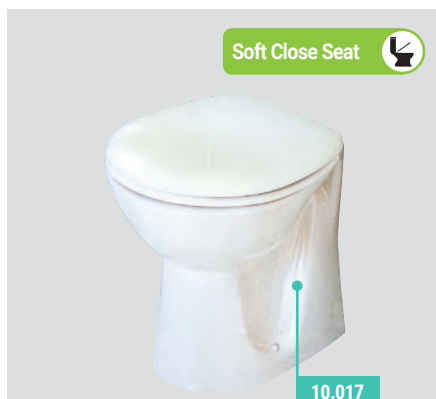

Cut out: 270mm

Belgravia Range

BELGRAVIA

Soft Close Seat 



Sherwood high gloss white seat shown.

For alternative colours see page 142



A traditional design with unmistakable period details, Belgravia is an affordable classic with a distinctive Victorian feel.

Belgravia WC

Description	Code	£ Ex VAT	£ Inc VAT
Belgravia WC Pan	24.0001	117.00	140.40
Belgravia Cistern inc fittings	24.0002	78.00	93.60
Rhone soft close seat	40.0001	57.00	68.40
Jollytronic universal bottom entry cistern fitting**	7.0000	99.00	118.80
Sherwood seat HGW	34.1098	78.00	93.60

Can be fitted with a Sherwood seat.
**For more information see page 245.

Belgravia Basin

Description	Code	£ Ex VAT	£ Inc VAT
Belgravia 1TH Basin	24.0003	82.00	98.40
Belgravia 2TH Basin	24.0004	82.00	98.40
Belgravia Pedestal	24.0005	33.00	39.60

FEATURES

- Soft close seat, lifts off for easy cleaning
- Water inlet left or right
- Soil can be turned left or right

Complete the LOOK

Accessories

Description	Code	£ Ex VAT	£ Inc VAT
Rockingham Glass Shelf	52.049	70.00	84.00
Rockingham Double Tumbler Holder	52.042	65.00	78.00
Rockingham Towel Ring	52.044	41.00	49.20

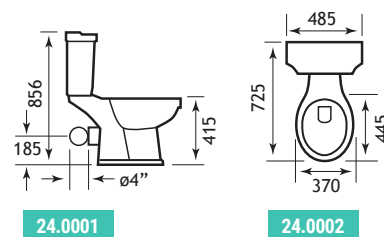

24.0001

24.0002

*Soil can be turned left or right 

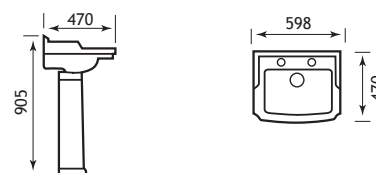

24.0005

24.0003/4

Bijou Range



A jewel in the Eastbrook range, featuring subtle angular lines to create a sleek and contemporary look.

BIJOU 550 1TH BASIN



Description	Code	£ Ex VAT	£ Inc VAT
Bijou 550mm 1TH basin	26.0075	81.00	97.20
Bijou Pedestal	26.0077	41.00	49.20

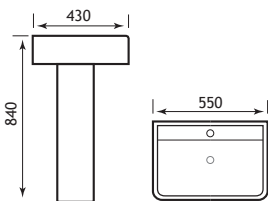

26.0077 26.0075

BIJOU PAN

- Rimless Tech
- Soft Close Seat



Description	Code	£ Ex VAT	£ Inc VAT
Bijou Pan	26.0071	137.00	164.40
Bijou Cistern	26.0074	71.00	85.20
Bijou Rimless Pan	26.0082	144.00	172.80
Bijou/Collindale Soft close seat	26.0070	56.00	67.20
Jollytronic universal bottom entry cistern fitting *	7.0000	99.00	118.80

*See page 245 for Jollytronic information.

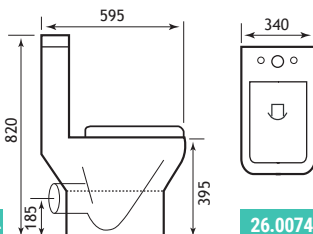

26.0071/82/74 26.0074

FEATURING Rimless Technology



- EASY CLEAN**
Nowhere for germs to hide.
- AESTHETICS**
Simplistic look.
- EFFICIENT**
A complete rim flush for effective cleaning.

Bijou Range



Soft Close Seat

Rimless Tech

Shown with Wendover Multirail.

Full range page 494

BIJOU WALL HUNG PAN

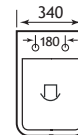
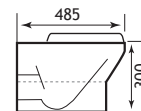

26.0072/26.0083

Description	Code	£ Ex VAT	£ Inc VAT
Bijou Wall Hung Pan	26.0072	152.00	182.40
Bijou Rimless Wall Hung Pan	26.0083	152.00	182.40
Bijou/Collindale Soft close seat	26.0070	56.00	67.20
Flexible Connector for BTW Pans	2.009	29.00	34.80

BIJOU 550MM 1TH BASIN

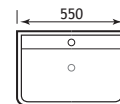
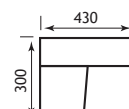

26.0075/26.0084

Description	Code	£ Ex VAT	£ Inc VAT
Bijou 550mm 1TH basin	26.0075	81.00	97.20
Bijou Semi pedestal	26.0085	34.00	40.80



See page 359 for Oslo Semi recessed furniture

BIJOU BACK TO WALL PAN

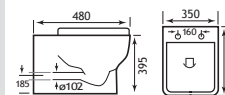

26.0073

Description	Code	£ Ex VAT	£ Inc VAT
Bijou BTW Pan	26.0073	144.00	172.80
Bijou Rimless BTW Pan	26.0084	144.00	172.80
Bijou/Collindale Soft close seat	26.0070	56.00	67.20
Flexible Connector for BTW Pans	2.009	29.00	34.80
Vantage Plain Hidden Cistern	17.001	133.00	159.60
Vantage Hidden Cistern with Jacket	17.3029	155.00	186.00
Eastbrook Jacket Hidden Cistern Bottom Inlet	53.001	82.00	98.40

BIJOU SEMI RECESSED 1TH BASIN

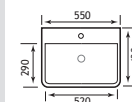
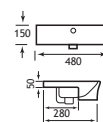

26.0076

Description	Code	£ Ex VAT	£ Inc VAT
Bijou Semi Recessed basin	26.0076	86.00	103.20

Cheverney Range



Simplicity and style come together in this modern inexpensive suite.

FEATURES

- Soft close seat, lifts off for easy cleaning
- Soil can be turned left or right on close coupled pan

CHEVERNEY BTW PAN



Soft Close Seat

Description	Code	£ Ex VAT	£ Inc VAT
Type 55 BTW WC pan	27.0101	126.00	151.20
Loire soft close seat	50.002	96.00	115.20
Loire Type 55 seat and cover	40.0002	20.00	24.00
Rhone soft close seat	40.0001	57.00	68.40

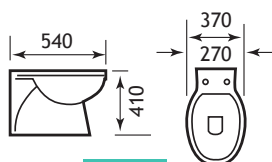

27.0101

CHEVERNEY CC PAN



Soft Close Seat

Description	Code	£ Ex VAT	£ Inc VAT
Cheverney Cistern	75.0022	51.00	61.20
Type 55 Pan	75.0020	60.00	72.00
Loire Soft Close Seat	50.002	96.00	115.20
Loire Seat & Cover	40.0002	20.00	24.00
Rhone soft close seat	40.0001	57.00	68.40
Jollytronic Universal Bottom Entry Cistern Fitting*	7.0000	99.00	118.80

*See page 245 for Jollytronic information.

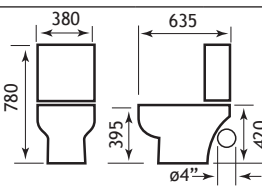

75.0020

75.0022

CHEVERNEY CORNER PAN



Soft Close Seat

Description	Code	£ Ex VAT	£ Inc VAT
Cheverney Corner Type 55 Pan			
Loire Corner Cistern inc fittings †	75.0011	95.00	114.00
Loire Close Coupled Pan	75.0001	88.00	105.60
Loire Soft Close Seat	50.002	96.00	115.20
Loire Seat & Cover	40.0002	20.00	24.00
Rhone Soft Close Seat	40.0001	57.00	68.40
Jollytronic Universal Bottom Entry Cistern Fitting*	7.0000	99.00	118.80

†Can only be fitted with 75.0001
*See page 245 for Jollytronic information.

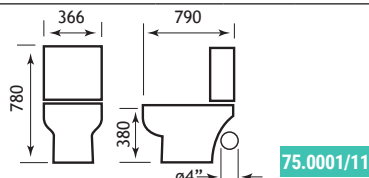

75.0001/11

Cheverney Range

CHEVERNEY CLOAKROOM BASINS



Cheverney Cloakroom Basins - 350 x 250			
Description	Code	£ Ex VAT	£ Inc VAT
350 x 250 cloakroom basin 1TH RH	75.0008	49.00	58.80
350 x 250 cloakroom basin 2TH	75.0018	49.00	58.80

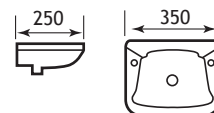

Cheverney Cloakroom Basins - 450 x 275			
Description	Code	£ Ex VAT	£ Inc VAT
450 x 275 cloakroom basin 1TH RH	75.0009	52.00	62.40
450 x 275 cloakroom basin 2TH	75.0019	52.00	62.40

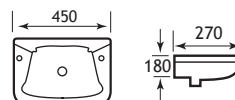

Cheverney Cloakroom Basins - 510 x 240			
Description	Code	£ Ex VAT	£ Inc VAT
510x240 cloakroom Basin 2TH	27.0921	30.00	36.00



CHEVERNEY SEMI RECESSED BASIN

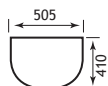

Cheverney Semi Recessed Basins			
Description	Code	£ Ex VAT	£ Inc VAT
Loire Semi-Recessed basin 1TH	75.0006	95.00	114.00
Loire Semi-Recessed Basin 2TH	75.0016	95.00	114.00

CHEVERNEY CORNER BASIN



Cheverney Corner Basins Type 55 (400)			
Description	Code	£ Ex VAT	£ Inc VAT
Loire 400 Corner Basin 1TH	75.0007	72.00	86.40
Loire 400 Corner Basin 2TH	75.0017	72.00	86.40
Loire Pedestal	75.0004	35.00	42.00

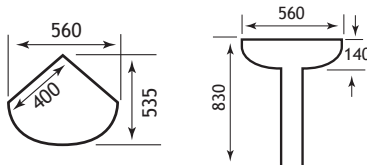

Cheverney Corner Basins Type 55			
Description	Code	£ Ex VAT	£ Inc VAT
Type 55 Corner Basin 2TH	27.0941	40.00	48.00
Loire Pedestal	75.0004	35.00	42.00

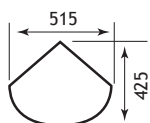

CHEVERNEY TYPE 55 BASIN



Cheverney Type 55 Basins (535)			
Description	Code	£ Ex VAT	£ Inc VAT
Loire 535 basin 1TH	75.0003	50.00	60.00
Loire 535 basin 2TH	75.0014	50.00	60.00
Loire Pedestal	75.0004	35.00	42.00
Semi Ped for 75.0003 & 75.0014	75.0025	33.00	39.60

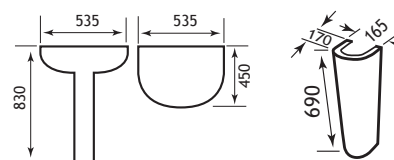

Cheverney Type 55 Basins			
Description	Code	£ Ex VAT	£ Inc VAT
Type 55 Basin 2TH †	27.0851	27.00	32.40
Loire Pedestal	75.0004	35.00	42.00

† While stocks last.

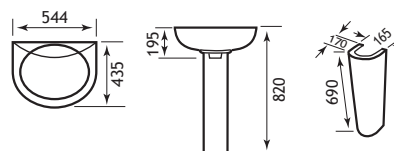

CHEVERNEY WALL HUNG BASIN



Cheverney Wall Hung Basin			
Description	Code	£ Ex VAT	£ Inc VAT
Wall hung basin 500mm 1TH †	60.0014	62.00	74.40

† While stocks last.

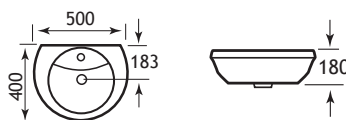

Cheverney Corner Basins Type 55 (450)			
Description	Code	£ Ex VAT	£ Inc VAT
Loire 450 Basin 1TH	75.0005	49.00	58.80
Loire 450 Basin 2TH	75.0015	49.00	58.80
Loire Pedestal	75.0004	35.00	42.00

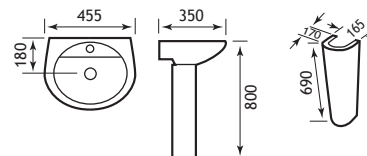

Cheltenham Range

CHELTEMHAM



Inspired by the elegance of a regency town, the timeless Cheltenham suite is a modern adaption of a traditional design.

FEATURES

- Soft close seat, lifts off for easy cleaning
- Soil can be turned left or right at back of pan
- Comfort height

Cheltenham			
Description	Code	£ Ex VAT	£ Inc VAT
Cheltenham WC Pan	27.0581	152.00	182.40
Cheltenham Cistern inc fittings	27.0591	99.00	118.80
Cheltenham Basin 598 1TH	27.0601	104.00	124.80
Cheltenham Basin 598 2TH	27.9601	99.00	118.80
Cheltenham Pedestal	27.0611	42.00	50.40
Cheltenham Soft Close Seat	50.008	94.00	112.80
Cheltenham Soft Close Seat	27.0961	71.00	85.20
Jollytronic Universal Bottom Entry Cistern fitting	7.0000	99.00	118.80

Soil can be turned left or right at back of pan.

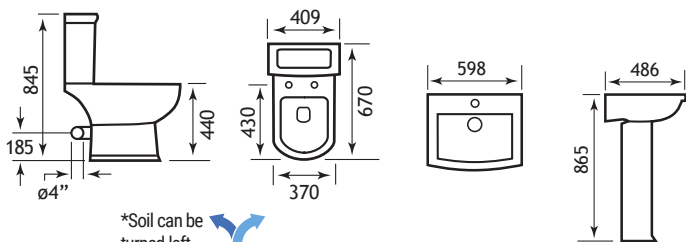

27.0581 27.0591

27.0601 / 27.9601 27.0611

Colorado Range

COLORADO

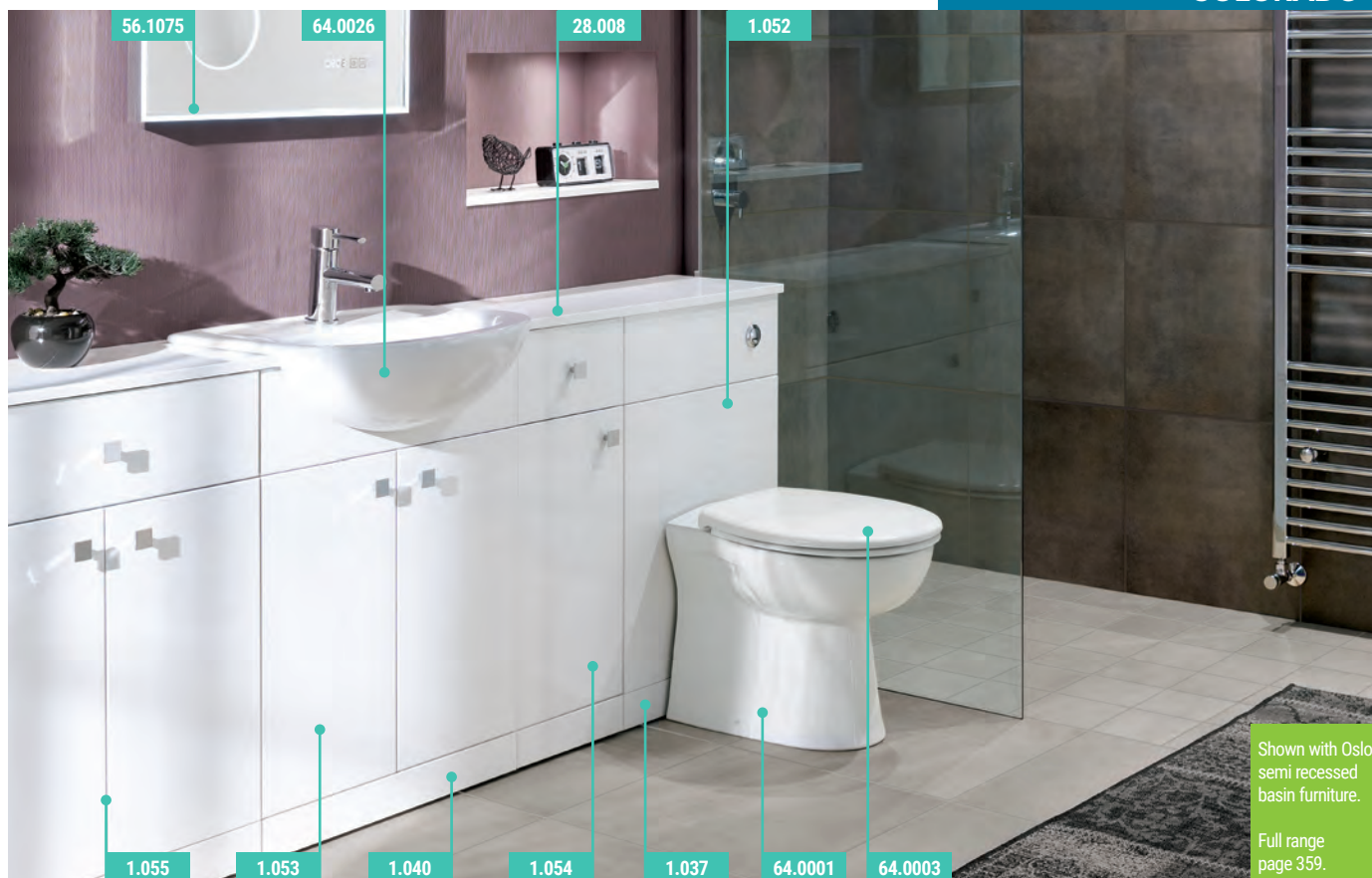

Shown with Oslo semi recessed basin furniture.

Full range page 359.

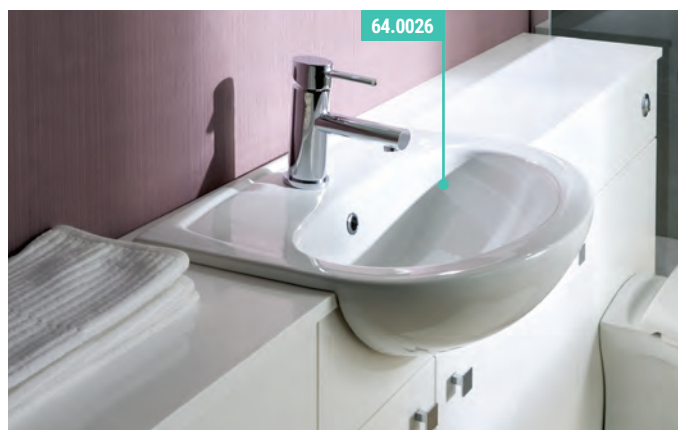

The affordable, simple design of the Colorado suite makes it the perfect partner for the Bonito range and other fitted bathroom furniture. Seat illustrated is the standard seat.

FEATURES

- Soft close seat, lifts off for easy cleaning
- Top fix seat

Description	Code	£ Ex VAT	£ Inc VAT
Colorado BTW WC Pan	64.0001	94.00	112.80
Colorado Seat	64.0003	35.00	42.00
Colorado Soft Close Seat	50.006	83.00	99.60
Colorado Semi Recessed Basin 1TH	64.0026	113.00	135.60

BTW Pan Extras

FEATURES - VANTAGE CISTERN

- WRAS approved flushing components
- Delay fill inlet valve - no water waste

Description	Code	£ Ex VAT	£ Inc VAT
Vantage Plain Hidden Cistern CP Push Button	17.001	133.00	159.60
Vantage Hidden Cistern with Jacket	17.3029	155.00	186.00
Eastbrook Jacket Hidden Cistern - Bottom Inlet	53.001	82.00	98.40
Flexible WC Connector for BTW Pans *	2.009	29.00	34.80

*Pan connector 2.009 is recommended for use with our BTW pans.

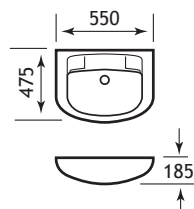

64.0026

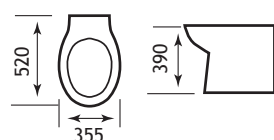

64.0001

Cut out 260mm

Oslo Semi Recessed Furniture

Description	Code	£ Ex VAT	£ Inc VAT
Oslo 60cm WC unit	1.052	228.00	273.60
Oslo 60cm base cupboard with drawer	1.055	212.00	254.40
Oslo 60cm basin unit	1.053	206.00	247.20
Bonito 150cm plinth (height 70mm)	1.040	18.00	21.60
Oslo 30cm base drawer unit LH	1.054	125.00	150.00
Bonito 60cm plinth (height 70mm)	1.037	14.00	16.80
Laminate Tops Gloss 2000 x 310 mm	28.008	100.00	120.00

Collindale Range



- Comfort Height
- Soft Close Seat
- Rimless Tech

Pictured with Wendover Multirail

For flush plates see p.247

The Collindale range features a high standard comfort height rimless pans, in which the design is not compromised. It's geometric shapes and simplistic functionality will suite any modern bathroom.

FEATURES

- Rimless Technology
- Soft close seat unclips for cleaning
- Semi recessed basin to match

COLLINDALE COMFORT BTW PAN

- Comfort Height
- Soft Close Seat
- Rimless Tech

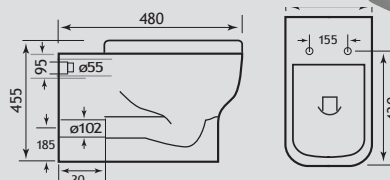

26.0068

Collindale Comfort Height BTW Pan

Description	Code	£ Ex VAT	£ Inc VAT
Collindale Rimless Comfort Height BTW Pan	26.0068	177.00	212.40
Bijou/Collindale Soft Close Seat	26.0070	56.00	67.20
Flexible Connector for BTW Pans	2.009	29.00	34.80

Bijou & Accessories

Description	Code	£ Ex VAT	£ Inc VAT
Bijou 550mm 1TH basin	26.0075	81.00	97.20
Bijou Pedestal	26.0077	41.00	49.20
Bijou Semi Recessed basin	26.0076	86.00	103.20
Langton 500 x 700 illuminated mirror	56.1073	185.00	222.00

Complete the LOOK

Complete the look by matching the 'Bijou' basin range (page 178-179) with the Collindale WC's.

These similar design styles allow contemporary to meet comfort. Pictured above.



Collindale Range



- Comfort Height
- Soft Close Seat
- Rimless Tech

Pictured with
Wendover
Multirail P494

FEATURING Rimless Technology

Rimless Tech

EASY CLEAN
Nowhere for germs to hide.

AESTHETICS
Simplistic look.

EFFICIENT
A complete rim flush for effective cleaning.

COLLINDALE COMFORT HEIGHT BTW CC PAN

- Comfort Height
- Soft Close Seat
- Rimless Tech

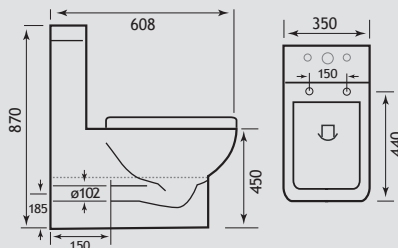

26.0067 26.0069

Description	Code	£ Ex VAT	£ Inc VAT
Collindale Rimless High Level BTW CC Pan	26.0067	177.00	212.40
Collindale Cistern	26.0069	67.00	80.40
Bijou/Collindale Soft Close Seat	26.0070	56.00	67.20
Jollytronic Universal Bottom Entry Cistern fitting *	7.0000	99.00	118.80

*See page 245 for Jollytronic information.

COLLINDALE BIDET



Description	Code	£ Ex VAT	£ Inc VAT
Collindale Bidet	26.0103	133.00	159.60

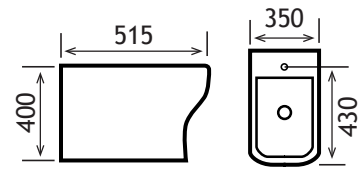

26.0103

Courchevel Range



FEATURES

- Soft close seat, lifts off for easy cleaning
- Soil can be turned left or right on close-coupled pan

COURCHEVEL BTW PAN

Soft Close Seat



Description	Code	£ Ex VAT	£ Inc VAT
Loire BTW WC Pan	27.0101	126.00	151.20
Loire Soft Close Seat	50.002	96.00	115.20
Rhone Soft Close Seat	40.0001	57.00	68.40
Loire Type 55 seat and cover	40.0002	20.00	24.00

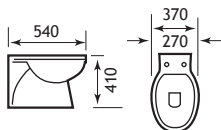

27.0101

COURCHEVEL CC PAN

Soft Close Seat



Description	Code	£ Ex VAT	£ Inc VAT
Courchevel Cistern	75.0023	51.00	61.20
Type 55 Pan	75.0020	60.00	72.00
Loire Soft Close Seat	50.002	96.00	115.20
Rhone Soft Close Seat	40.0001	57.00	68.40
Loire Type 55 seat and cover	40.0002	20.00	24.00
Jollytronic Universal Bottom Entry Cistern fitting**	7.0000	99.00	118.80

**See page 245 for Jollytronic information.

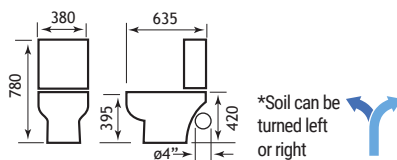

75.0023 75.0020

COURCHEVEL CORNER PAN

Soft Close Seat



Description	Code	£ Ex VAT	£ Inc VAT
Type 55 Corner cistern†	75.0011	95.00	114.00
Loire Pan Close Coupled	75.0001	88.00	105.60
Loire Soft Close Seat	50.002	96.00	115.20
Rhone Soft Close Seat	40.0001	57.00	68.40
Loire Type 55 seat and cover	40.0002	20.00	24.00
Jollytronic Universal Bottom Entry Cistern fitting**	7.0000	99.00	118.80

**See page 245 for Jollytronic information.
†Can only be fitted with 75.0001

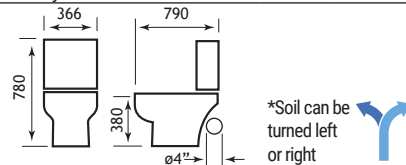

75.0011 75.0001

Courchevel Range

COURCHEVEL CLOAKROOM BASINS

A versatile range with a variety of products available. A modern and affordable suite, a welcome addition to any bathroom..



Courchevel Cloakroom Basins - 350 x 250

Description	Code	£ Ex VAT	£ Inc VAT
350 x 250 cloakroom basin 1TH RH	75.0008	49.00	58.80
350 x 250 cloakroom basin 2TH	75.0018	49.00	58.80

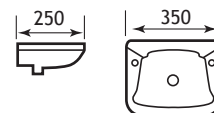

Courchevel Cloakroom Basins - 450 x 275

Description	Code	£ Ex VAT	£ Inc VAT
450 x 275 cloakroom basin 1TH RH	75.0009	52.00	62.40
450 x 275 cloakroom basin 2TH	75.0019	52.00	62.40

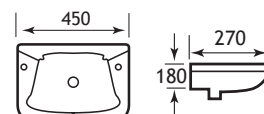

Courchevel Cloakroom Basins - 510 x 240

Description	Code	£ Ex VAT	£ Inc VAT
510 x 240 cloakroom Basin 2TH	27.0921	30.00	36.00

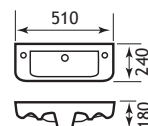

COURCHEVEL SEMI RECESSED



Courchevel Semi Recessed Basins

Description	Code	£ Ex VAT	£ Inc VAT
Loire Semi-Recessed Basin 1TH	75.0006	95.00	114.00
Loire Semi-Recessed Basin 2TH	75.0016	95.00	114.00

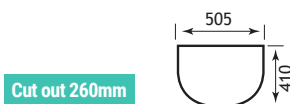

COURCHEVEL CORNER BASINS



Courchevel Corner Basins Type 55 (400)

Description	Code	£ Ex VAT	£ Inc VAT
Loire 400 Corner Basin 1TH	75.0007	72.00	86.40
Loire 400 Corner Basin 2TH	75.0017	72.00	86.40
Loire Pedestal	75.0004	35.00	42.00

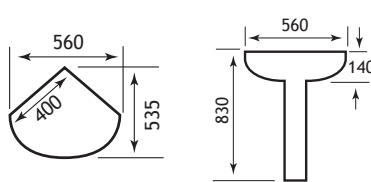

Courchevel Corner Basins Type 55

Description	Code	£ Ex VAT	£ Inc VAT
Type 55 Corner Basin 2TH	27.0941	40.00	48.00
Loire Pedestal	75.0004	35.00	42.00

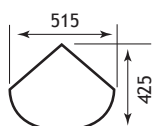

COURCHEVEL TYPE 55 BASINS



Courchevel Type 55 Basins (535)

Description	Code	£ Ex VAT	£ Inc VAT
Loire 535 Basin 1TH	75.0003	50.00	60.00
Loire 535 Basin 2TH	75.0014	50.00	60.00
Loire Pedestal	75.0004	35.00	42.00
Semi Ped for 75.0003 & 75.0014	75.0025	33.00	39.60

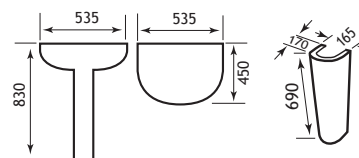

Courchevel Type 55 Basins

Description	Code	£ Ex VAT	£ Inc VAT
Type 55 basin 2TH †	27.0851	27.00	32.40
Loire Pedestal	75.0004	35.00	42.00

† While stocks last.

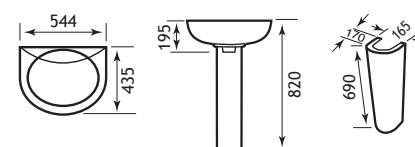

COURCHEVEL WALL HUNG BASIN



Description	Code	£ Ex VAT	£ Inc VAT
Wall Hung Basin 500mm 1TH †	60.0014	62.00	74.40

† While stocks last.

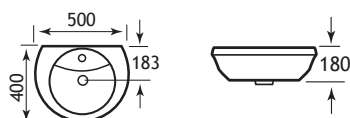

Crowthorne Range



Crowthorne Range

Soft Close Seat 

CROWTHORNE

A fusion of a modern shaped basin and a more traditional pan to add flair to any bathroom.

FEATURES

- Rimless Technology
- Soft close seat unclips for cleaning
- Semi recessed basin to match

CROWTHORNE 500



Description	Code	£ Ex VAT	£ Inc VAT
Crowthorne Semi Pedestal	26.0030	39.00	46.80
Crowthorne Basin 500mm 1TH	26.0029	81.00	97.20

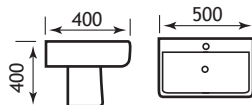

26.0030

26.0029

CROWTHORNE 560



Description	Code	£ Ex VAT	£ Inc VAT
Crowthorne Semi Pedestal	26.0030	39.00	46.80
Crowthorne Basin 560mm 1TH	26.0027	89.00	106.80

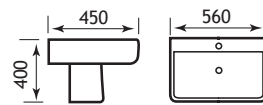

26.0030

26.0027

CROWTHORNE 500 1TH



Description	Code	£ Ex VAT	£ Inc VAT
Crowthorne Basin 500mm 1TH	26.0029	81.00	97.20
Crowthorne Pedestal	26.0028	44.00	52.80

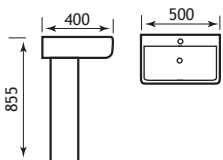

26.0028

26.0029

CROWTHORNE 560 1TH



Description	Code	£ Ex VAT	£ Inc VAT
Crowthorne Basin 560mm 1TH	26.0027	89.00	106.80
Crowthorne Pedestal	26.0028	44.00	52.80

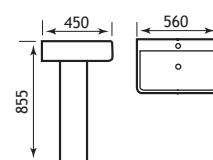

26.0028

26.0027

Shown with Alento Accessories P300

Soft Close Seat 

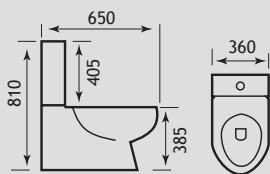

26.0031

Description	Code	£ Ex VAT	£ Inc VAT
Crowthorne WC Pan	26.0031	92.00	110.40
Crowthorne Cistern inc Fittings	26.0032	66.00	79.20
Crowthorne Soft Close Seat	26.0033	58.00	69.60
Jollytronic Universal Bottom Entry Cistern fitting	7.0000	99.00	118.80

Doc M Pack

Items included in the Doc M pack are: + Pan + Cistern (inc fittings) + Seat ring + 4 x grab rails + 1 x swing arm + Toilet roll holder + Basin + Basin hangers + Tap + Grated waste + Bottle trap

CLOSE COUPLED DOC M PACK

"A clean looking and practical suite, built with accessibility and safety in mind."



Close Coupled Doc M Pack - White With Stainless Steel Grips

Description	Code	£ Ex VAT	£ Inc VAT
Close coupled Doc M packs	27.0139	471.00	565.20

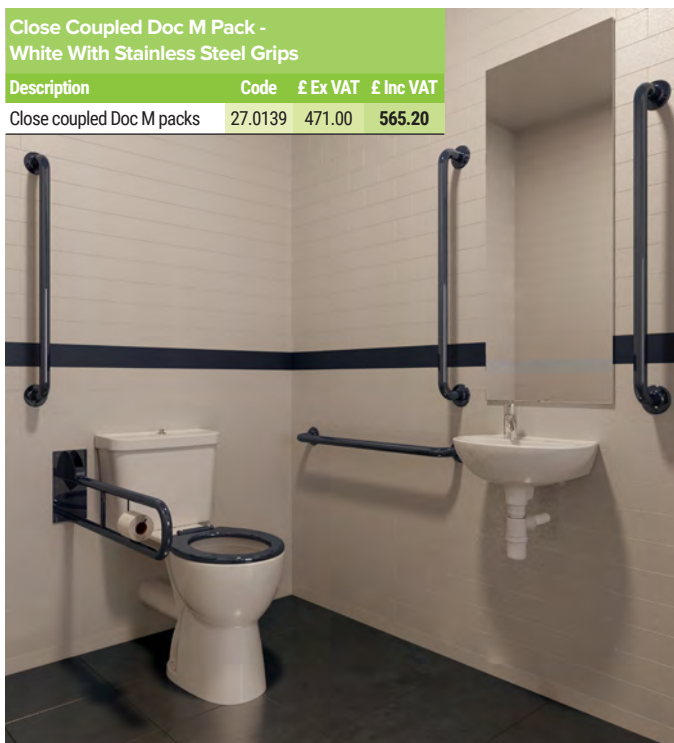

Close Coupled Doc M Pack - White With Blue Grips

Description	Code	£ Ex VAT	£ Inc VAT
Close coupled Doc M packs	27.0131	427.00	512.40

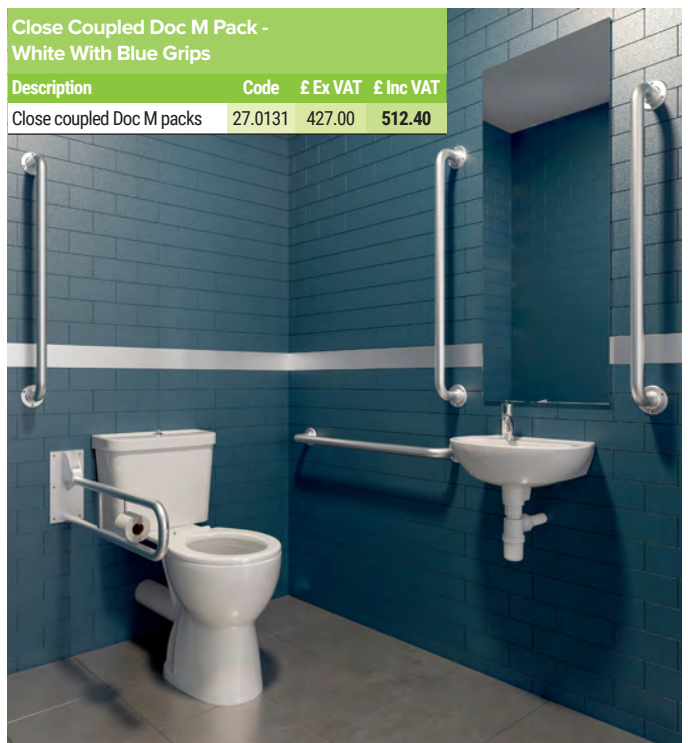

Doc M Pack



Low Level Doc M Pack With White Grips

Description	Code	£ Ex VAT	£ Inc VAT
Low level Doc M packs	27.0121	447.00	536.40



Low Level Doc M Pack With Blue Grips

Description	Code	£ Ex VAT	£ Inc VAT
Low level Doc M packs	27.0125	427.00	512.40

DOC M PACK ACCESSORIES

The below codes are for individual sale only. They will differ from the items that come as part of the Doc M packs.

Individual Accessory Prices

Description	Colour	Code	£ Ex VAT	£ Inc VAT
Grab Rails 600mm (5 pack)	White	40.0191	88.00	105.60
Grab Rails 600mm (5 pack)	Blue	40.0195	88.00	105.60
Grab Rails 600mm (5 pack)	S. Steel	40.0199	150.00	180.00
Tap from Doc M Pack	Chrome	40.0181	116.00	139.20
Padded Back Rest	White	40.0211	57.00	68.40
'Doc M' Low Level padded back rest	Blue	40.0215	57.00	68.40
Padded Back Rest	S. Steel	40.0219	98.00	117.60

Individual Sanitaryware

Description	Colour	Code	£ Ex VAT	£ Inc VAT
Basin from Doc M pack 1TH no overflow	White	27.0171	98.00	117.60
Jollytronic universal bottom entry cistern fitting		7.0000	99.00	118.80

N.B. WC pan height is 450mm, pan with seat height is 480mm

Grab Rails And Swing Arms

Description	Colour	Code	£ Ex VAT	£ Inc VAT
300mm Grab Rail	White	40.0221	15.00	18.00
300mm Grab Rail	Blue	40.0225	15.00	18.00
300mm Grab rail	S. Steel	40.0229	25.00	30.00
450mm Grab Rail	White	40.0231	18.00	21.60
450mm Grab Rail	Blue	40.0235	18.00	21.60
450mm Grab rail	S. Steel	40.0239	31.00	37.20
600mm Grab rail	White	40.0241	26.00	31.20
600mm Grab Rail	Blue	40.0245	26.00	31.20
600mm Grab rail	S. Steel	40.0249	42.00	50.40
Swing Arm	White	40.0251	74.00	88.80
Swing Arm	Blue	40.0256	74.00	88.80
Swing Arm	S. Steel	40.0259	126.00	151.20

Seats

Description	Code	£ Ex VAT	£ Inc VAT
Loire/Arkitekt Deluxe Seat	50.001	34.00	40.80
Loire Soft Close Seat	50.002	96.00	115.20
Loire Seat & Cover	40.0002	20.00	24.00
Rhone Soft Close Seat	40.0001	57.00	68.40
Seat ring from Doc M pack White	40.0161	18.00	21.60
Seat ring from Doc M pack Blue	40.0165	25.00	30.00



Grab rail pack consists of five hand rails. Swing arm is separate.

The Doc M pack includes 4 grab rails and one swing arm

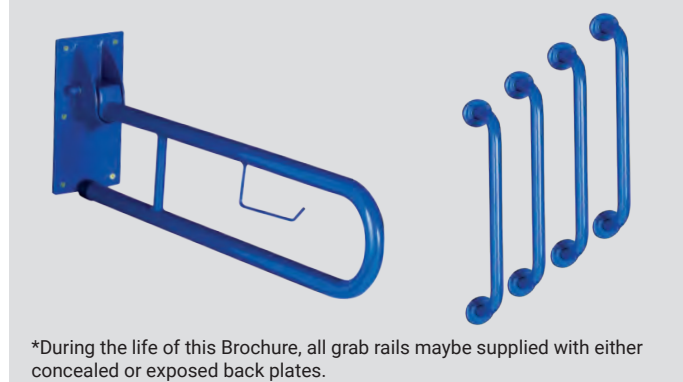

*During the life of this Brochure, all grab rails maybe supplied with either concealed or exposed back plates.

Dura Range

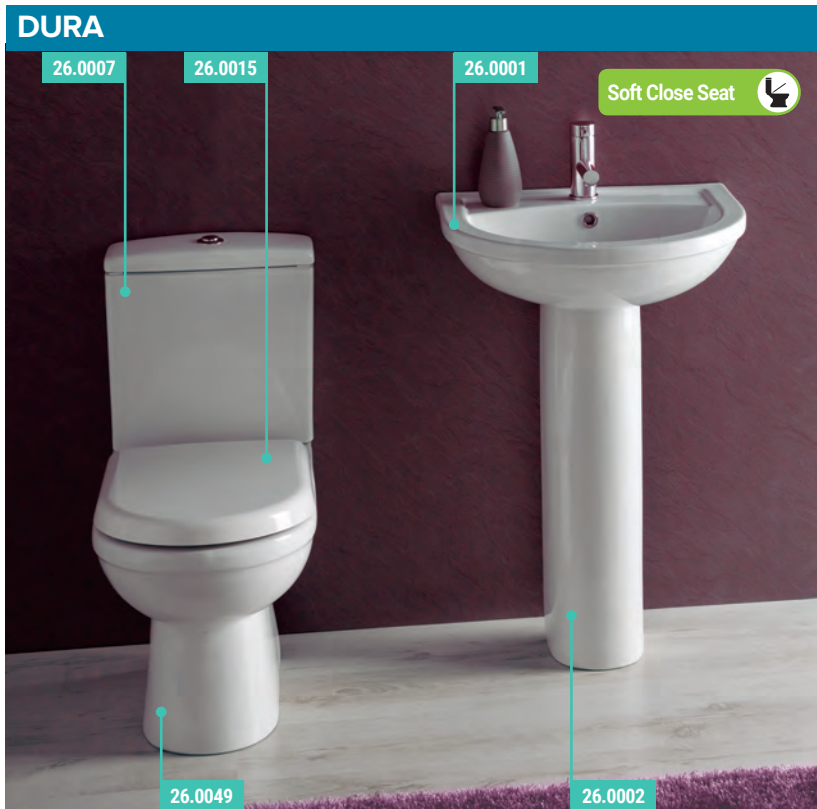

The Dura suite is a fusion - having a modern design whilst still retaining some features of the more traditional suite.

FEATURES

- Soft close seat option
- Top fix seat
- Soft close seat lifts off for easy cleaning
- Multiple basin options
- Comfort height option

Description	Code	£ Ex VAT	£ Inc VAT
Dura Basin 550mm 1TH inc fixings	26.0001	56.00	67.20
Dura Pedestal	26.0002	35.00	42.00
Dura Basin 500mm 1TH inc fixings	26.0003	53.00	63.60

DURA CORNER BASIN 460



Description	Code	£ Ex VAT	£ Inc VAT
Dura Corner Basin 460mm 1TH inc fixings	26.0013	45.00	54.00
Dura Pedestal	26.0002	35.00	42.00

DURA CLOAKROOM BASIN



Description	Code	£ Ex VAT	£ Inc VAT
Dura Cloakroom Basin 450mm 2TH inc fixings	26.0012	41.00	49.20
Dura Cloakroom Basin 360mm 2TH	26.0011	36.00	43.20

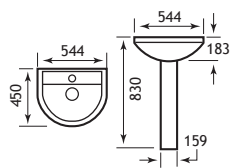

26.0001



26.0003

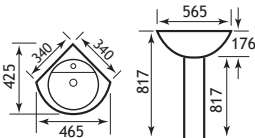

26.0013

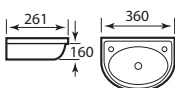

26.0011

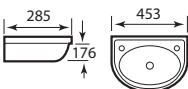

26.0012

DURA BASIN 500



Description	Code	£ Ex VAT	£ Inc VAT
Basin 500mm 2TH inc Fixings	26.0025	53.00	63.60
Dura Pedestal	26.0002	35.00	42.00

DURA BASIN 450



Description	Code	£ Ex VAT	£ Inc VAT
Dura Basin 450mm 1th inc fixings	26.0005	41.00	49.20
Dura Basin 450mm 2TH inc fixings	26.0026	45.00	54.00
Dura Semi Pedestal inc fixings	26.0004	33.00	39.60
Dura Pedestal	26.0002	35.00	42.00

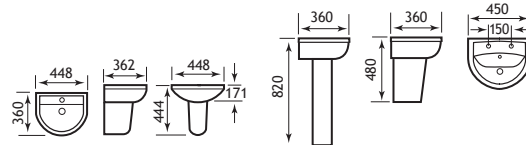

26.0005 26.0004/5 26.0002/26 26.0004/26 26.0026

DURA SEMI RECESSED BASIN 1TH



Description	Code	£ Ex VAT	£ Inc VAT
Dura Semi recessed basin 1TH	26.0009	51.00	61.20

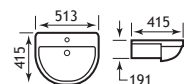

26.0009 Cut out 260mm

Dura Range

DURA BTW PAN

Soft Close Seat 



Description	Code	£ Ex VAT	£ Inc VAT
Dura BTW Pan inc fixings *	26.0008	81.00	97.20
Dura Deluxe Soft Close Seat	26.0015	49.00	58.80
Flexible WC Connector BTW Pans	2.009	29.00	34.80

*BTW can only be fitted with soft close seat.

DURA HIGH LEVEL BTW

Comfort Height 



Description	Code	£ Ex VAT	£ Inc VAT
Dura High Level BTW Pan	26.0047	134.00	160.80
Dura Deluxe Soft Close Seat	26.0015	49.00	58.80
Flexible WC Connector BTW Pans	2.009	29.00	34.80

For compatible furniture see pages 360-362.

DURA WALL HUNG

Soft Close Seat 



Description	Code	£ Ex VAT	£ Inc VAT
Dura Wall Hung Pan	26.0048	137.00	164.40
Dura Deluxe Soft Close Seat	26.0015	49.00	58.80
Dura Deluxe Seat	50.011	29.00	34.80

DURA BTW CC PAN

Soft Close Seat 



Description	Code	£ Ex VAT	£ Inc VAT
Dura BTW CC Pan	26.0049	118.00	141.60
Dura Cistern inc fittings	26.0007	56.00	67.20
Dura Economy Seat	26.0014	24.00	28.80
Dura Deluxe Soft Close Seat	26.0015	49.00	58.80
Dura Deluxe Seat	50.011	29.00	34.80
Jollytronic universal bottom entry cistern fitting	7.0000	99.00	118.80



Description	Code	£ Ex VAT	£ Inc VAT
Dura BTW CC Pan LH Exit*	26.0050	118.00	141.60
Dura BTW CC Pan RH Exit*	26.0051	118.00	141.60
Dura Cistern inc fittings	26.0007	56.00	67.20
Dura Economy Seat	26.0014	24.00	28.80
Dura Deluxe Soft Close Seat	26.0015	49.00	58.80
Dura Deluxe Seat	50.011	29.00	34.80

*Pipework needs to be floor level.

Left hand soil shown

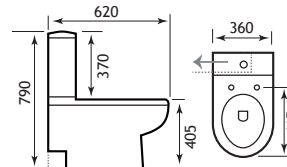

*Soil exit is either left or right hand, ensure correct configuration when ordering.

DURA HIGH LEVEL BTW CC PAN

Comfort Height 

Soft Close Seat 



Description	Code	£ Ex VAT	£ Inc VAT
Dura High Level BTW CC Pan	26.0043	150.00	180.00
Dura Cistern inc fittings	26.0007	56.00	67.20
Dura Economy Seat	26.0014	24.00	28.80
Dura Deluxe Soft Close Seat	26.0015	49.00	58.80
Dura Deluxe Seat	50.011	29.00	34.80
Jollytronic universal bottom entry cistern fitting	7.0000	99.00	118.80

DURA HIGH LEVEL CC PAN

Comfort Height 

Soft Close Seat 



Description	Code	£ Ex VAT	£ Inc VAT
Dura High Level CC Pan *	26.0046	134.00	160.80
Dura Cistern inc fittings	26.0007	56.00	67.20
Dura Economy Seat	26.0014	24.00	28.80
Dura Deluxe Soft Close Seat	26.0015	49.00	58.80
Dura Deluxe Seat	50.011	29.00	34.80
Jollytronic universal bottom entry cistern fitting	7.0000	99.00	118.80

*Soil can be turned left or right at the back of the pan 

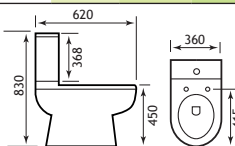

DURA PAN

Soft Close Seat 



Description	Code	£ Ex VAT	£ Inc VAT
Dura Pan inc fixings *	26.0006	78.00	93.60
Dura Cistern inc fittings	26.0007	56.00	67.20
Dura Economy Seat	26.0014	24.00	28.80
Dura Deluxe Soft Close Seat	26.0015	49.00	58.80
Dura Deluxe Seat	50.011	29.00	34.80
Jollytronic universal bottom entry cistern fitting	7.0000	99.00	118.80

*Soil can be turned left or right at the back of the pan 

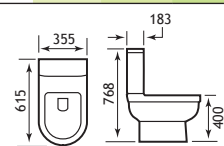

Elysée Range

ELYSÉE



Shown with Courtauld tap 56.2040. See P702

A versatile range with a variety of products available. A modern and affordable suite, a welcome addition to any bathroom.

FEATURES

- Soft close seat, lifts off for easy cleaning
- Soil can be turned left or right on close coupled pan

ELYSÉE 55 BTW



Elysée BTW Pan			
Description	Code	£ Ex VAT	£ Inc VAT
Type 55 BTW WC pan	27.0101	126.00	151.20
Loire Soft Close Seat	50.002	96.00	115.20
Loire Type 55 seat and cover	40.0002	20.00	24.00
Rhone Soft Close Seat	40.0001	57.00	68.40

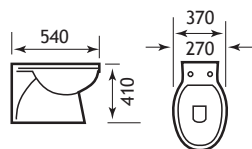

27.0101

ELYSÉE CC PAN



Elysée CC pan			
Description	Code	£ Ex VAT	£ Inc VAT
Elysee Cistern	75.0021	51.00	61.20
Type 55 Pan	75.0020	60.00	72.00
Loire Soft Close Seat	50.002	96.00	115.20
Loire Seat & Cover	40.0002	20.00	24.00
Rhone Soft Close Seat	40.0001	57.00	68.40
Jollytronic universal bottom entry cistern fitting	7.0000	99.00	118.80

*See page 245 for Jollytronic information.

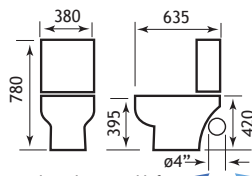

75.0021 75.0020

ELYSÉE CORNER 55 PAN



Elysée corner type 55 pan			
Description	Code	£ Ex VAT	£ Inc VAT
Loire corner cistern inc fittings†	75.0011	95.00	114.00
Loire close coupled WC pan	75.0001	88.00	105.60
Loire soft close seat	50.002	96.00	115.20
Loire Seat & Cover	40.0002	20.00	24.00
Rhone soft close seat	40.0001	57.00	68.40
Jollytronic universal bottom entry cistern fitting*	7.0000	99.00	118.80

†Can only be fitted with 75.0001

*See page 245 for Jollytronic information.

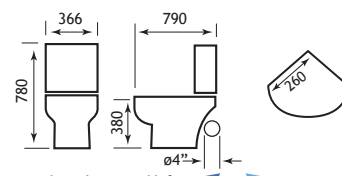

75.0011 75.0001

Elysée Range

ELYSÉE CLOAKROOM BASINS

A versatile range with a variety of products available. A modern and affordable suite, a welcome addition to any bathroom.



Elysée Cloakroom Basins - 350x250

Description	Code	£ Ex VAT	£ Inc VAT
350 x 250 cloakroom basin 1TH	75.0008	49.00	58.80
350 x 250 cloakroom basin 2TH	75.0018	49.00	58.80

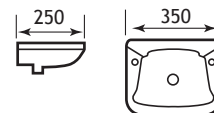

Elysée Cloakroom Basins - 450x275

Description	Code	£ Ex VAT	£ Inc VAT
450 x 275 cloakroom basin 1TH	75.0009	52.00	62.40
450 x 275 cloakroom basin 2TH	75.0019	52.00	62.40

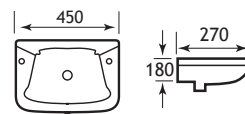

Elysée Cloakroom Basins - 510x240

Description	Code	£ Ex VAT	£ Inc VAT
510 x 240 cloakroom Basin 2TH	27.0921	30.00	36.00

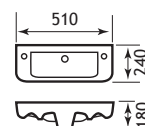

ELYSÉE SEMI RECESSED BASINS



Elysée Semi Recessed Basins

Description	Code	£ Ex VAT	£ Inc VAT
Semi-Recessed basin 1TH	75.0006	95.00	114.00
Semi-Recessed Basin 2TH	75.0016	95.00	114.00

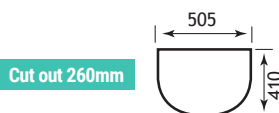

ELYSÉE CORNER BASINS



Elysée Corner Basins Type 55 (400)

Description	Code	£ Ex VAT	£ Inc VAT
Loire 400 corner basin 1TH	75.0007	72.00	86.40
Loire 400 Corner Basin 2TH	75.0017	72.00	86.40
Loire pedestal	75.0004	35.00	42.00

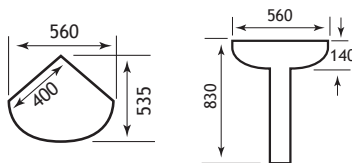

ELYSÉE WALL HUNG BASINS



Elysée Wall Hung Basin

Description	Code	£ Ex VAT	£ Inc VAT
Type 55 wall hung basin 500mm 1TH †	60.0014	62.00	74.40

† While stocks last.

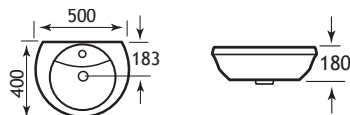

ELYSÉE TYPE 55 BASINS



Elysée Type 55 Basins (535)

Description	Code	£ Ex VAT	£ Inc VAT
Loire 535 basin 1TH	75.0003	50.00	60.00
Loire 535 basin 2TH	75.0014	50.00	60.00
Loire pedestal	75.0004	35.00	42.00
Loire Semi Ped for 75.0003 & 75.0014	75.0025	33.00	39.60

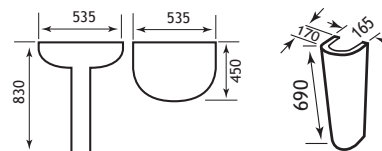

Elysée Type 55 Basins

Description	Code	£ Ex VAT	£ Inc VAT
Type 55 basin 2TH†	27.0851	27.00	32.40
Loire pedestal	75.0004	35.00	42.00

† While stocks last.

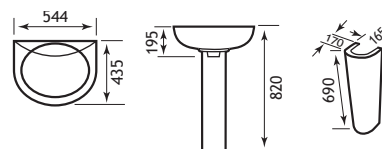

Farringdon Range



The Farringdon range features soft curves and sweeping edges, perfect for any modern day bathroom. The versatile range includes a comfort height, rimless pan.

FEATURES

- Rimless Technology
- Top fix seat
- Soft close seat lifts off for easy cleaning
- Short projection
- Cloakroom basin or full pedestal
- Entire range is comfort height seating level

FARRINGDON BASINS



Farringdon/Northall 450MM 1TH Basin			
Description	Code	£ Ex VAT	£ Inc VAT
Farringdon 450mm 1TH basin	26.0064	49.00	58.80
Farringdon Semi ped	26.0065	41.00	49.20

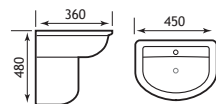

Farringdon/Northall 500MM 1TH Basin			
Description	Code	£ Ex VAT	£ Inc VAT
Farringdon 500mm 1TH basin	26.0066	65.00	78.00
Farringdon Semi ped	26.0065	41.00	49.20

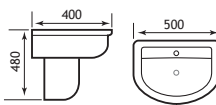

Farringdon/Northall 550MM 1TH Basin			
Description	Code	£ Ex VAT	£ Inc VAT
Farringdon 550mm 1TH basin	26.0062	69.00	82.80
Farringdon Semi ped	26.0065	41.00	49.20

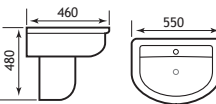

FEATURING Rimless Technology



EASY CLEAN
Nowhere for germs to hide.

AESTHETICS
Simplistic look.

EFFICIENT
A complete rim flush for effective cleaning.

Farringdon Range

FARRINGDON CC PAN



Description	Code	£ Ex VAT	£ Inc VAT
Farringdon CC pan*	26.0059	147.00	176.40
Farringdon Rimless CC pan	26.0080	147.00	176.40
Farringdon Cistern	26.0061	67.00	80.40
Northall / Farringdon Wrap Over Soft Close Seat	26.0056	50.00	60.00
Jollytronic universal bottom entry cistern fitting	7.0000	99.00	118.80

FARRINGDON WALL HUNG PAN



Description	Code	£ Ex VAT	£ Inc VAT
Farringdon Rimless Wall hung pan*	26.0081	155.00	186.00
Northall / Farringdon Soft Close Seat	26.0056	50.00	60.00

*Can be fitted with a 26.0042 soft close seat as an alternative. See page 223

FARRINGDON BACK TO WALL CC PAN



Description	Code	£ Ex VAT	£ Inc VAT
Farringdon BTW CC pan*	26.0057	147.00	176.40
Farringdon Rimless BTW CC pan	26.0078	155.00	186.00
Farringdon Cistern	26.0061	67.00	80.40
Northall / Farringdon Wrap Over Soft Close Seat	26.0056	50.00	60.00
Jollytronic universal bottom entry cistern fitting	7.0000	99.00	118.80

FARRINGDON BACK TO WALL PAN

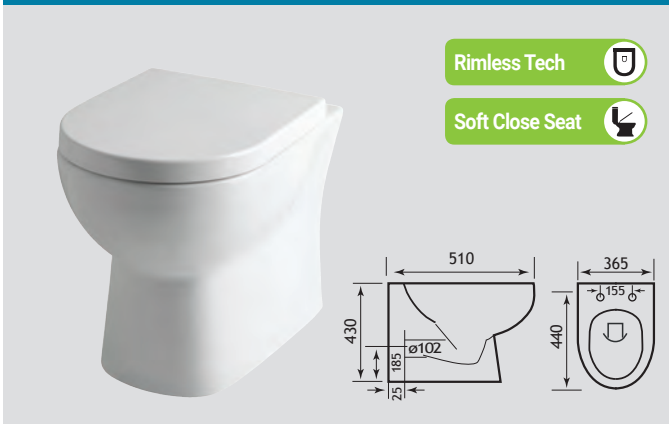

Description	Code	£ Ex VAT	£ Inc VAT
Farringdon BTW pan*	26.0058	147.00	176.40
Northall / Farringdon Wrap Over Soft Close Seat	26.0056	50.00	60.00
Farringdon Rimless BTW pan	26.0079	147.00	176.40
Flexible WC Connector for BTW Pans	2.009	29.00	34.80

*Can be fitted with a 26.0042 soft close seat as an alternative, see page 223.
For compatible furniture see pages 360-362.

FARRINGDON BASINS



Farringdon/Northall 450MM 1TH Basin			
Description	Code	£ Ex VAT	£ Inc VAT
Farringdon 450mm 1TH basin	26.0064	49.00	58.80
Farringdon Pedestal	26.0063	44.00	52.80

Farringdon/Northall 500MM 1TH Basin			
Description	Code	£ Ex VAT	£ Inc VAT
Farringdon 500mm 1TH basin	26.0066	65.00	78.00
Farringdon Pedestal	26.0063	44.00	52.80

Farringdon/Northall 550MM 1TH Basin			
Description	Code	£ Ex VAT	£ Inc VAT
Farringdon 550mm 1TH basin	26.0062	69.00	82.80
Farringdon Pedestal	26.0063	44.00	52.80

Kompact Range



Where space is a major concern, Kompact comes into its own. The WC pan and cistern project just 610mm.

Kompact WC

Description	Code	£ Ex VAT	£ Inc VAT
Kompact WC pan	27.0301	150.00	180.00
Kompact cistern inc fittings	27.0331	81.00	97.20
Temptation/Kompact seat	21.1141	53.00	63.60
Temptation/Kompact soft close seat	21.1151	111.00	133.20
Jollytronic universal bottom entry cistern fitting**	7.0000	99.00	118.80

Soil can be turned left or right at back of pan.
 **For more information see page 245.

FEATURES

- Soft close seat, lifts off for easy cleaning
- Soil can be turned left or right

KOMPACT 550 BASIN



Kompact Basins

Description	Code	£ Ex VAT	£ Inc VAT
Kompact 550mm basin 1TH	27.0341	87.00	104.40
Temptation pedestal	27.0461	37.00	44.40

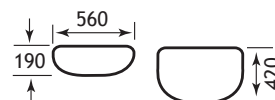

KOMPACT IN A BOX

'Kompact in a box' includes everything you need for the WC:

- * Kompact pan
- * Kompact cistern complete with fittings and push button
- * Soft close white seat

Simply bolt together
Nothing could be easier

Kompact			
Description	Code	£ Ex VAT	£ Inc VAT
Kompact in a box	99.016	296.00	355.20

Extras

Description	Code	£ Ex VAT	£ Inc VAT
Treviso 500x700mm Blue LED Portrait Mirror	40.1003	170.00	204.00
Hooper mono basin c/w clicker waste	56.2045	100.00	120.00

Kompact Range



KOMPACT BASIN

Can be fitted on a full pedestal.



Kompact Basin

Description	Code	£ Ex VAT	£ Inc VAT
Kompact Basin 457mm 1TH	27.0401	62.00	74.40
Temptation pedestal	27.0461	37.00	44.40

KOMPACT CLOAKROOM BASIN

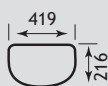

Kompact Cloakroom Basin

Description	Code	£ Ex VAT	£ Inc VAT
Kompact cloakroom basin	27.0381	46.00	55.20
419 x 216 1TH			

KOMPACT CLOAKROOM BASIN

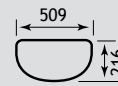

Kompact Cloakroom Basin

Description	Code	£ Ex VAT	£ Inc VAT
Cloakroom basin	27.0391	50.00	60.00
509 x 216 1TH			

Kompact Range

KOMPACT



Pictured with Salerno range accessories. See pages 302-303

Soft Close Seat

Where space is a major concern, Kompact comes into its own. The WC pan and cistern project just 610mm, the corner cistern and pan project 805mm. The corner cistern and neat basins make the range extremely versatile in confined areas such as cloakrooms and en-suites..

FEATURES

- Soft close seat, lifts off for easy cleaning
- Soil can be turned left or right
- Top fix seat

KOMPACT CORNER BASIN



Description	Code	£ Ex VAT	£ Inc VAT
Corner cloakroom basin 1TH	27.0371	71.00	85.20

KOMPACT WC



*Soil can be turned left or right at the back of the pan

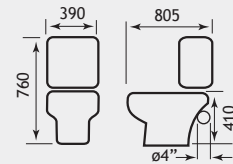

27.0301 & 27.0311

Kompact WC

Description	Code	£ Ex VAT	£ Inc VAT
Kompact WC pan	27.0301	150.00	180.00
Kompact corner cistern inc fittings	27.0311	113.00	135.60
Temptation/Kompact seat	21.1141	53.00	63.60
Temptation/Kompact soft close seat	21.1151	111.00	133.20
Jollytronic universal bottom entry cistern fitting*	7.0000	99.00	118.80

Soil can be turned left or right at back of pan.

**For more information see page 245.

Kompact Range



Pictured with Oslo Slimline, see p 359 for full range.

Soft Close Seat

KOMPACT BTW



27.0321 & 21.1141

Kompact BTW			
Description	Code	£ Ex VAT	£ Inc VAT
Kompact BTW pan	27.0321	120.00	144.00
Temptation/Kompact seat	21.1141	53.00	63.60
Temptation/Kompact soft close seat	21.1151	111.00	133.20

BTW Pan extras

Description	Code	£ Ex VAT	£ Inc VAT
Vantage Plain Hidden Cistern CP Push Button	17.001	133.00	159.60
Vantage Hidden Cistern with Jacket	17.3029	155.00	186.00
Eastbrook Jacket Hidden Cistern - Bottom Inlet	53.001	82.00	98.40
Flexible WC Connector for BTW Pans	2.009	29.00	34.80

*Pan connector 2.009 is recommended for use with our BTW pans.

FEATURES - VANTAGE CISTERN

- WRAS approved flushing components
- Delay fill inlet valve - no water waste

KOMPACT SEMI RECESSED BASIN



27.0361

Kompact Semi Recessed Basin			
Description	Code	£ Ex VAT	£ Inc VAT
Kompact reduced depth SR basin 1TH	27.0361	84.00	100.80
Kompact reduced depth SR basin 2TH	27.9361	84.00	100.80

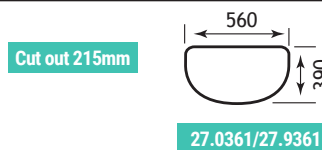

27.0361/27.9361

Oslo Semi Recessed Slimline Furniture

Description	Code	£ Ex VAT	£ Inc VAT
Oslo slimline basin unit	1.051	206.00	247.20
Oslo WC unit only	1.287	228.00	273.60
Oslo WC unit plinth	1.288	10.00	12.00
Laminate Tops Gloss 1200 x 310mm	28.009	59.00	70.80
Bonito 60cm plinth (height 70cm)	1.037	14.00	16.80

Linea Range



The Linea is characterised by its simple shapes and clean, modern lines. It is both practical and integrates well with any surroundings

FEATURES

- Soft close seat, lifts off for easy cleaning
- Linea pan matches a variety of basins
- Top fix seat

Linea Basins

Description	Code	£ Ex VAT	£ Inc VAT
Linea basin 560mm 1TH	56.0011	95.00	114.00
Linea pedestal	56.0012	60.00	72.00
Quba semi pedestal for 56.0031	56.0063	59.00	70.80
Alternative full pedestal*	56.0032	57.00	68.40

Clicker or flipper waste recommended. *While stocks last.

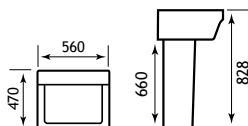

LINEA WC



Description	Code	£ Ex VAT	£ Inc VAT
Linea pan & soft close seat	56.0013	272.00	326.40
Linea cistern inc fittings	56.0015	90.00	108.00
Linea soft close seat	56.0014	83.00	99.60
Jollytronic universal bottom entry cistern fitting*	7.0000	99.00	118.80

*For more information see page 245.

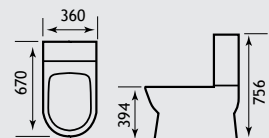

56.0013/56.0015

Linea Range



Soft Close Seat 

Shown with Wendover Multitrail page 494



Minima basin, for the rest of the Minima range see page 218-219.



Metro basin, for the rest of the Metro range see page 214-215.



Shown with Prado 650 taps, full range on page 687

Ultima basin, for the rest of the Ultima range see page 232-233.

Alternative Basins To Match Linea Pan

Description	Code	£ Ex VAT	£ Inc VAT
Minima basin 1TH	56.0016	83.00	99.60
Minima pedestal	56.0017	60.00	72.00
Metro basin 610mm 1TH	56.0026	116.00	139.20
Metro pedestal	56.0027	55.00	66.00
Ultima basin 590mm 1TH	56.0001	89.00	106.80
Ultima pedestal	56.0002	53.00	63.60

Extras

Description	Code	£ Ex VAT	£ Inc VAT
Seattle 500 x 700mm two-layer mirror	56.1018	102.00	122.40
Salerno glass brush holder	52.032	24.00	28.80
Prado 650 mono basin c/w click waste	56.2005	96.00	115.20
Salerno towel holder	52.025	31.00	37.20
Salerno glass shelf	52.031	31.00	37.20

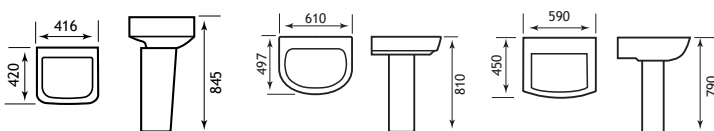

56.0016/56.0017

56.0026/56.0027

56.0001/56.0002

Lisbon II Range

LISBON II



The striking contemporary styling and the soft clean lines of the Lisbon suite are taken to a new level on the Lisbon II range with small but beautiful design details to create a beautiful modern bathroom.

FEATURES

- Soft close seat, lifts off for easy cleaning
- Soil can be turned left or right
- Top fix seat

LISBON II - BASIN

Description	Code	£ Ex VAT	£ Inc VAT
Lisbon II 600mm Basin 1TH	64.0014	59.00	70.80
Lisbon II Pedestal	64.0013	44.00	52.80

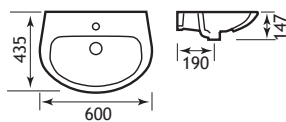

64.0014/64.0013

LISBON II - 600 BASIN



Height of basin & pedestal: 815mm

64.0014

64.0013

Lisbon II Range



LISBON II - CORNER WC



Description	Code	£ Ex VAT	£ Inc VAT
Lisbon II Corner Cistern	64.0024	77.00	92.40
Lisbon II CC Pan	64.0023	118.00	141.60
Lisbon II BTW & Corner Pan Seat	64.0011	30.00	36.00
Corner Pan Soft Close Seat	64.0025	77.00	92.40
Lisbon II Corner Cistern*	7.0000	99.00	118.80

See page 245 for Jollytronic information.

LISBON II - BTW WC CLOSE COUPLED



Description	Code	£ Ex VAT	£ Inc VAT
Lisbon II Cistern inc Dual Flush	64.0005	84.00	100.80
Lisbon II BTW CC WC Pan White	64.0004	146.00	175.20
Lisbon II Soft Close Seat	64.0006	77.00	92.40
Jollytronic universal bottom entry cistern fitting*	7.0000	99.00	118.80

See page 245 for Jollytronic information.

LISBON II - WALL HUNG 600 BASIN



Lisbon II - 600MM Wall Hung Basin			
Description	Code	£ Ex VAT	£ Inc VAT
Lisbon II 600mm Basin 1TH	64.0014	59.00	70.80
Lisbon II Semi Pedestal	64.0015	34.00	40.80

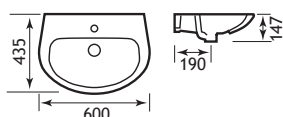

LISBON II - SEMI BTW WC



Lisbon II - Semi BTW Close Coupled WC			
Description	Code	£ Ex VAT	£ Inc VAT
Lisbon II Semi BTW CC WC Pan	64.0007	125.00	150.00
Lisbon II Semi BTW CC WC Pan	64.0005	84.00	100.80
Lisbon II Soft Close Seat	64.0006	77.00	92.40
Jollytronic universal bottom entry cistern fitting*	7.0000	99.00	118.80

See page 245 for Jollytronic information.

LISBON II - WALL HUNG WC



Lisbon II - Wall Hung WC			
Description	Code	£ Ex VAT	£ Inc VAT
Lisbon II Wall Hung WC Pan	64.0008	125.00	150.00
Lisbon II Wall Hung Pan Soft Close Seat	64.0009	63.00	75.60

LISBON II - WALL HUNG 550 BASIN



Lisbon II - 550MM Wall Hung Basin			
Description	Code	£ Ex VAT	£ Inc VAT
Lisbon II 550mm Basin 1TH	64.0012	52.00	62.40
Lisbon II Semi Pedestal	64.0015	34.00	40.80

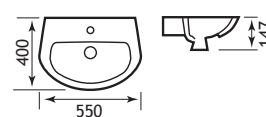

Lisbon II Range

LISBON II



The striking contemporary styling and the soft clean lines of the Lisbon suite are taken to a new level on the Lisbon II range with small but beautiful design details to create a beautiful modern bathroom.

FEATURES

- Soft close seat, lifts off for easy cleaning
- Top fix seat

LISBON II - 450 BASIN 1TH



64.0019

Lisbon II Cloakroom

Description	Code	£ Ex VAT	£ Inc VAT
450 Cloakroom Basin 1TH	64.0019	48.00	57.60

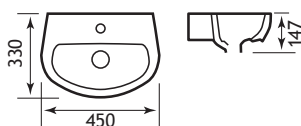

64.0019

LISBON II - 570 BASIN 1TH



64.0020



64.0021

Lisbon II Cloakroom

Description	Code	£ Ex VAT	£ Inc VAT
570mm Offset Basin LH 1TH	64.0021	59.00	70.80
570mm Offset Basin RH 1TH	64.0020	59.00	70.80

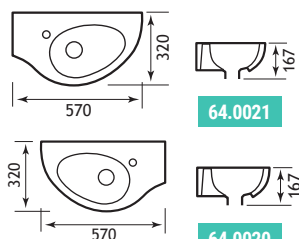

64.0021

64.0020

LISBON II - BTW CLOSE COUPLED WC

Lisbon II - BTW Close Coupled WC

Description	Code	£ Ex VAT	£ Inc VAT
Lisbon II Cistern inc Dual Flush	64.0005	84.00	100.80
Lisbon II BTW CC WC Pan White	64.0004	146.00	175.20
Lisbon II Soft Close Seat	64.0006	77.00	92.40
Jollytronic universal bottom entry cistern fitting*	7.0000	99.00	118.80

See page 245 for Jollytronic information.

LISBON II - 600 BASIN 1TH



64.0018

Lisbon II Cloakroom

Description	Code	£ Ex VAT	£ Inc VAT
Lisbon II 600mm Basin 1TH	64.0018	52.00	62.40

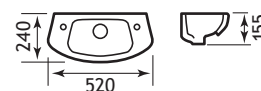

64.0018

Lisbon II Range



Pictured with Bonito furniture, to see full range please see page 314-319

Lisbon II BTW Pan And Semi-Recessed Basin			
Description	Code	£ Ex VAT	£ Inc VAT
Lisbon II BTW Pan	64.0010	104.00	124.80
Lisbon II BTW & Corner Pan Seat	64.0011	30.00	36.00
Lisbon II BTW & Corner Pan Soft Close Seat	64.0025	77.00	92.40
Lisbon II Semi Recessed Basin 1TH	64.0022	71.00	85.20
Flexible WC Connector for BTW Pans	2.009	29.00	34.80

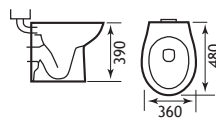

64.0010

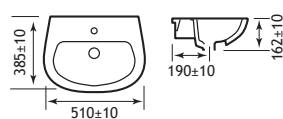

64.0022

Bonito Furniture			
Description	Code	£ Ex VAT	£ Inc VAT
Bonito 60cm basin unit	1.028	213.00	255.60
Bonito 60cm WC unit	1.029	236.00	283.20
Laminate Tops Gloss 1500 x 310 mm	28.007	59.00	70.80
Bonito 120cm plinth (height 70mm)	1.039	16.00	19.20

Extras			
Description	Code	£ Ex VAT	£ Inc VAT
Status Showerbath 5mm	23.0035R	502.00	602.40
Seattle 500 x 700mm two-layer mirror	56.1018	102.00	122.40

LISBON II - 550 CORNER BASIN 1TH



64.0017

Lisbon II Corner Basins			
Description	Code	£ Ex VAT	£ Inc VAT
Lisbon II 550 x 550 Corner Basin 1TH	64.0017	77.00	92.40

LISBON II - 450 CORNER BASIN 1TH



64.0016

Lisbon II Corner Basins			
Description	Code	£ Ex VAT	£ Inc VAT
Lisbon II 450 x 450 Corner Basin 1TH	64.0016	52.00	62.40

Loire Range

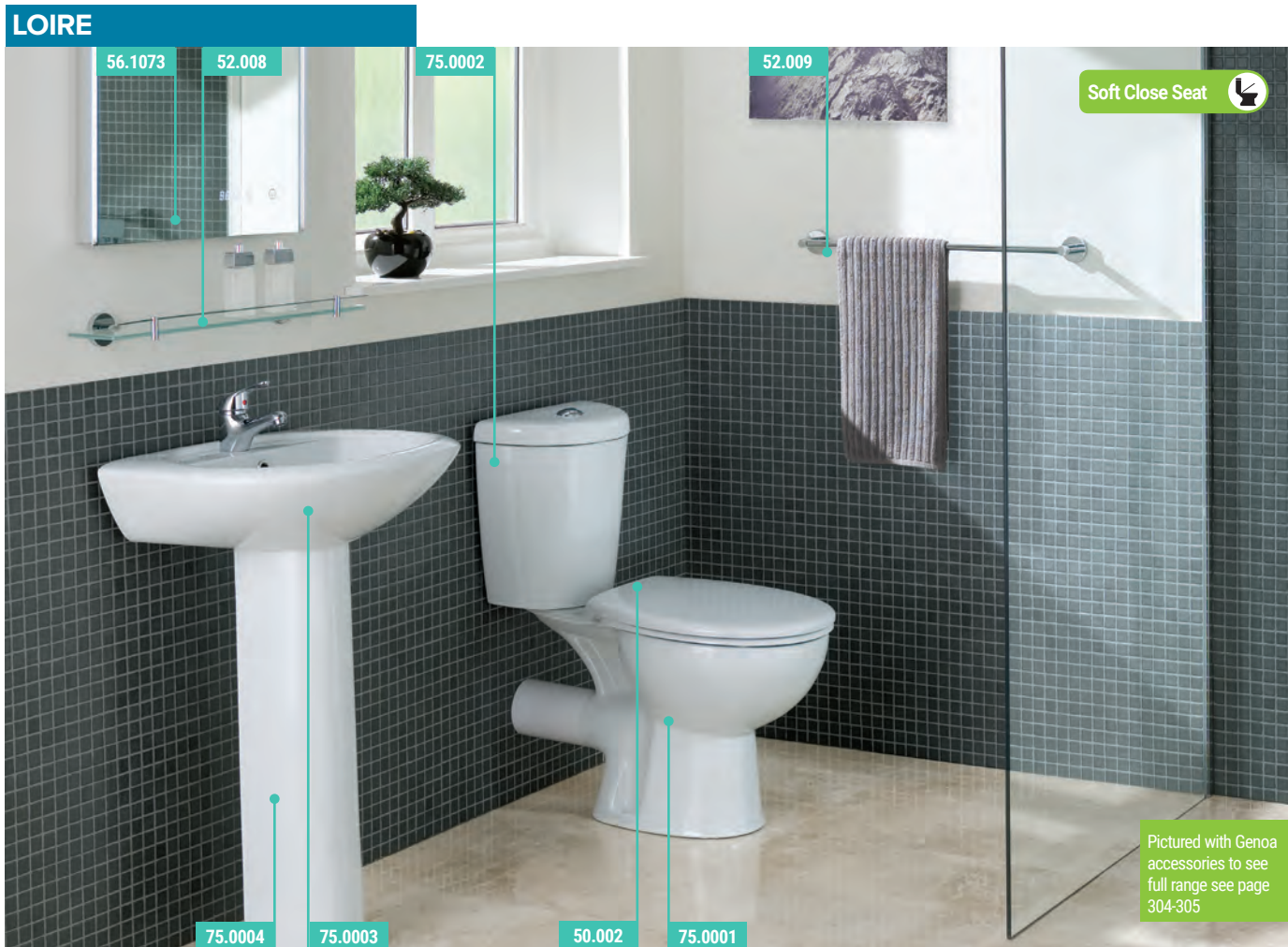

Loire personifies modern French design and blends beautifully into most modern and contemporary bathroom settings. Its slender, smooth curves emphasise the style and panache of this well-priced suite.

FEATURES

- Soft close seat, lifts off for easy cleaning
- Soil can be turned left or right

LOIRE WC

Description	Code	£ Ex VAT	£ Inc VAT
Loire close coupled WC pan	75.0001	88.00	105.60
Loire/Anjou close coupled cistern inc fittings	75.0002	70.00	84.00
Loire/Arkitekt deluxe seat	50.001	34.00	40.80
Loire soft close seat	50.002	96.00	115.20
Loire Seat & Cover	40.0002	20.00	24.00
Rhone soft close seat	40.0001	57.00	68.40
Jollytronic universal bottom entry cistern fitting	7.0000	99.00	118.80

*For more information see page 245.

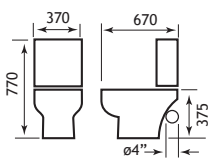

75.0001/2

*Soil can be turned left or right at the back of the pan

LOIRE IN A BOX

Simply bolt together.



Includes:

- * Loire pan
- * Loire cistern complete with fittings and push button
- * Standard white seat

Description	Code	£ Ex VAT	£ Inc VAT
Loire in a box	99.017	176.00	211.20

Loire Range

LOIRE BASINS



75.0003

Loire 535 Basins

Description	Code	£ Ex VAT	£ Inc VAT
Loire 535 basin 1TH	75.0003	50.00	60.00
Loire 535 basin 2TH	75.0014	50.00	60.00
Loire Semi Ped for 75.0003 & 75.0014	75.0025	33.00	39.60
Loire pedestal	75.0004	35.00	42.00

Loire 450 Basins

Description	Code	£ Ex VAT	£ Inc VAT
Loire 450 basin 1TH	75.0005	49.00	58.80
Loire 450 basin 2TH	75.0015	49.00	58.80
Loire pedestal	75.0004	35.00	42.00
Jollytronic Universal Bottom Entry Cistern Fitting	7.0000	99.00	118.80

Extras

Description	Code	£ Ex VAT	£ Inc VAT
Genoa single towel rail	52.009	32.00	38.40
Genoa glass shelf with barrier	52.008	30.00	36.00
Langton 500x700 mirror	56.1073	185.00	222.00

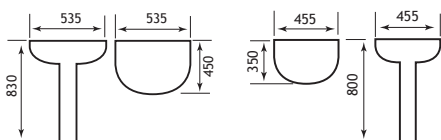

75.0004 & 75.0013/14

75.0004 & 75.0005/15



52.008

75.0003

LOIRE CLOAKROOM 450 BASIN

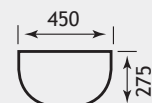

75.0009 & 75.0019

LOIRE CLOAKROOM 450 BASINS

Description	Code	£ Ex VAT	£ Inc VAT
Loire 450 x 275 cloakroom basin 1TH RH	75.0009	52.00	62.40
Loire 450 x 275 cloakroom basin 2TH	75.0019	52.00	62.40

LOIRE CLOAKROOM 350 BASIN

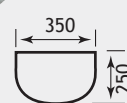

75.0008 & 75.0018

LOIRE CLOAKROOM 350 BASINS

Description	Code	£ Ex VAT	£ Inc VAT
Loire 350 x 250 cloakroom basin 1TH RH	75.0008	49.00	58.80
Loire 350 x 250 cloakroom basin 2TH	75.0018	49.00	58.80

Loire Range

LOIRE



Loire personifies modern French design and blends beautifully into most modern and contemporary bathroom settings. Its slender, smooth curves emphasise the style and panache of this well-priced suite.

FEATURES

- WRAS approved flushing components
- Eco lower flush volume of 5/3 litres
- Delay fill inlet valve - no water waste

Loire WC			
Description	Code	£ Ex VAT	£ Inc VAT
Loire close coupled WC pan	75.0001	88.00	105.60
Loire corner cistern inc fittings	75.0011	95.00	114.00
Rhone soft close seat	40.0001	57.00	68.40
Loire Seat & Cover	40.0002	20.00	24.00
Loire/Arkitekt deluxe seat	50.001	34.00	40.80
Loire soft close seat	50.002	96.00	115.20
Jollytronic universal bottom entry cistern fitting	7.0000	99.00	118.80

LOIRE WC



Loire Corner Basin

Description	Code	£ Ex VAT	£ Inc VAT
Loire 400 corner basin 1TH	75.0007	72.00	86.40
Loire 400 Corner Basin 2TH	75.0017	72.00	86.40
Loire pedestal	75.0004	35.00	42.00

LOIRE CORNER BASIN

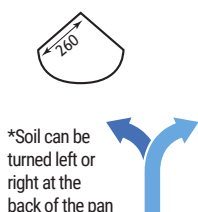
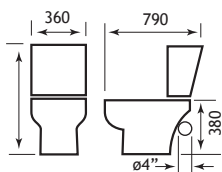

75.0001/75.0011

Loire Range



Soft Close Seat

The furniture illustrated is the Oslo semi-recessed range - see pages 359.

LOIRE BTW

LOIRE BTW PAN

Description	Code	£ Ex VAT	£ Inc VAT
Loire BTW WC pan & Fixing Bolts	75.0010	126.00	151.20
Loire Seat & Cover	40.0002	20.00	24.00
Loire/Arkitekt deluxe seat	50.001	34.00	40.80
Loire soft close seat	50.002	96.00	115.20
Rhone soft close seat	40.0001	57.00	68.40

FEATURES

- WRAS approved flushing components
- Eco lower flush volume of 5/3 litres
- Delay fill inlet valve - no water waste

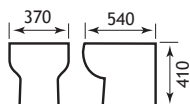

75.0010

LOIRE SEMI RECESSED BASINS

LOIRE SEMI RECESSED BASINS

Description	Code	£ Ex VAT	£ Inc VAT
Loire Semi-Recessed basin 1TH	75.0006	95.00	114.00
Loire Semi-Recessed Basin 2TH	75.0016	95.00	114.00

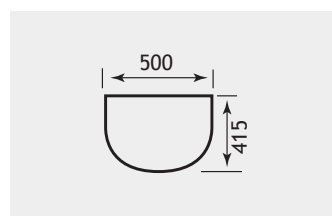

75.0006 / 75.0016

Cut out 260mm

BTW PAN EXTRAS

Description	Code	£ Ex VAT	£ Inc VAT
Vantage Plain Hidden Cistern CP Push Button	17.001	133.00	159.60
Vantage Hidden Cistern with Jacket	17.3029	155.00	186.00
Eastbrook Jacket Hidden Cistern - Bottom Inlet	53.001	82.00	98.40
Flexible WC Connector for BTW Pans*	2.009	29.00	34.80

*Pan connector 2.009 is recommended for use with our BTW pans.

OSLO SEMI-RECESSED FURNITURE

Description	Code	£ Ex VAT	£ Inc VAT
Oslo 60cm WC unit	1.052	228.00	273.60
Oslo 60cm basin unit	1.053	206.00	247.20
Laminate Tops Gloss 1500 x 310 mm	28.007	59.00	70.80
Bonito 60cm plinth (height 70mm)	1.037	14.00	16.80

Maestro Range

MAESTRO



Maestro Range



With its clear-cut contours and clean design, the elegant Maestro takes its inspiration from the maritime theme.

FEATURES

- Soft close seat, lifts off for easy cleaning
- Top fix seat

Maestro			
Description	Code	£ Ex VAT	£ Inc VAT
Maestro pan & soft close seat	56.0043	304.00	364.80
Maestro cistern	56.0045	101.00	121.20
Maestro soft close seat	56.0044	78.00	93.60
Maestro basin 600mm 1TH	56.0041	99.00	118.80
Maestro pedestal	56.0042	63.00	75.60
Jollytronic universal bottom entry cistern fitting**	7.0000	99.00	118.80
Genoa metal towel ring	52.014	25.00	30.00
Genoa spindle roll holder	52.007	28.00	33.60
Genoa metal brush holder	52.013	65.00	78.00
Genoa metal soap dispenser	52.005	41.00	49.20
Langton 500 x 700 illuminated mirror	56.1073	185.00	222.00
Leith Basin Mono inc push button waste	79.0020	72.00	86.40

**For more information see page 245.

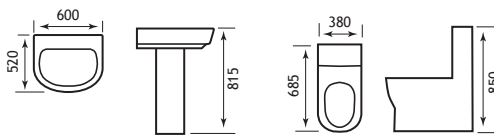

56.0041/56.0042

56.0043/56.0045



Pictured with Genoa accessories, to see full range see pages 304-305.

Also shown with Wingrave multirail, for full range see page 502

To view full range of Leith taps see page 708

Metro Range

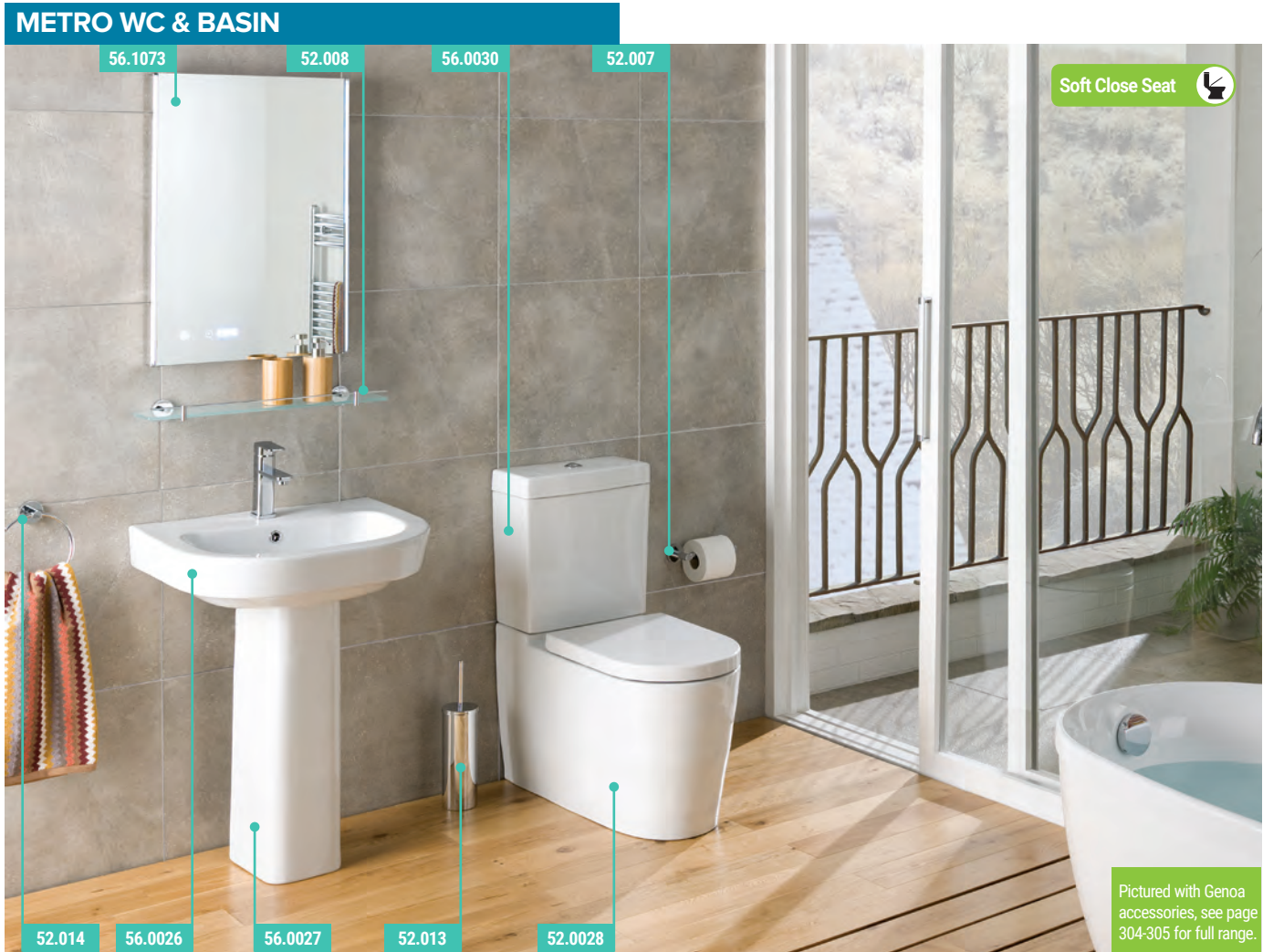

Pictured with Genoa accessories, see page 304-305 for full range.

Metro's simple yet striking design is characterised by a series of curves and straight lines, appealing to anyone who likes the minimalist look.

FEATURES

- Soft close seat, lifts off for easy cleaning
- Basin fits full and semi pedestals
- Metro pan matches a variety of basins
- Top fix seat

WALL TO SPIGOT MEASUREMENT

The metro toilet offers a vast gap between the spigot and wall leaving you enough room to connect to any existing soil pipes currently coming from the floor.

Code	Description	Floor to Spigot	Wall to Spigot	Open Foot Print
56.0028	Metro Pan	185	240	Yes
56.0058	Metro BTW Pan	185	85	Yes

Metro WC & Basin			
Description	Code	£ Ex VAT	£ Inc VAT
Metro pan & soft close seat	56.0028	344.00	412.80
Metro cistern inc fittings	56.0030	91.00	109.20
Metro soft close seat	56.0029	83.00	99.60
Metro basin 610mm 1TH	56.0026	116.00	139.20
Metro pedestal	56.0027	55.00	66.00
Jollytronic universal bottom entry cistern fitting	7.0000	99.00	118.80

**For more information see page 245.

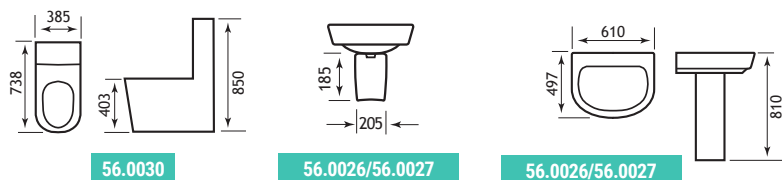

Metro Range

METRO BTW PAN

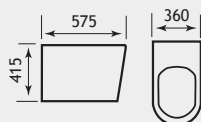

56.0058/56.0060

BTW Pan

Description	Code	£ Ex VAT	£ Inc VAT
Metro BTW Pan & soft close seat	56.0058	322.00	386.40
Metro BTW pan soft close seat	56.0060	75.00	90.00

Hidden Cistern & Flush Plate

Description	Code	£ Ex VAT	£ Inc VAT
Concealed Cistern 568 x 445 x 80mm	73.0004	84.00	100.80
V Series Flush Plate	73.0010	23.00	27.60

Semi-Pedestal & Semi-Recessed Basin

Description	Code	£ Ex VAT	£ Inc VAT
Metro semi-pedestal for 56.0026	56.0065	59.00	70.80
Metro semi-recessed 610mm basin 1TH	56.0026	116.00	139.20

METRO SEMI RECESSED BASIN

Clicker or flipper waste recommended.

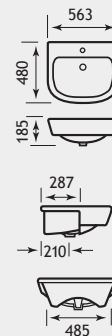

Cut out 260mm

56.0064



56.0026

73.0010/73.0004

For full range & specification of hidden cisterns & flush plates see pages 246-247

52.014

52.0065

52.013

56.0058

METRO ALTERNATIVE BASINS



56.0011

52.014

Linea basin. For the rest of the Linea range see pages 202-203

56.0012



56.0016

52.014

Minima basin. For the rest of the Minima range see pages 218-219

56.0017

ALTERNATIVE BASINS TO MATCH METRO PAN

Description	Code	£ Ex VAT	£ Inc VAT
Linea basin 560mm 1TH	56.0011	95.00	114.00
Linea pedestal	56.0012	60.00	72.00
Minima basin 1TH	56.0016	83.00	99.60
Minima pedestal	56.0017	60.00	72.00

Clicker or flipper waste recommended.

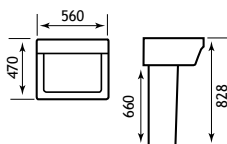

56.0011/56.0012

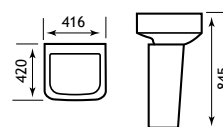

56.0016/56.0017

Metro Range

METRO SHORT PROJECTION WC & BASIN



A new take and continuation our of Metro range. It's simple yet striking design is characterised by a series of curves and straight lines, appealing to anyone who likes the minimalist look.

FEATURES

- Space saving
- 2 in 1 combination
- Water saving
- Hot & cold feed
- Tap included

METRO SHORT PROJECTION CISTERN WITH BASIN

Description	Code	£ Ex VAT	£ Inc VAT
Metro short projection cistern & tap	26.0102	144.00	172.80
Metro short projection CC Pan	26.0093	158.00	189.60
Metro short projection rimless CC Pan	26.0099	165.00	198.00
Metro short projection CC BTW Pan	26.0092	168.00	201.60
Metro short projection rimless CC BTW Pan	26.0098	175.00	210.00
Metro short projection soft close seat	26.0105	53.00	63.60
Metro short projection cistern	26.0094	67.00	80.40

OLSO SLIMLINE FURNITURE

Description	Code	£ Ex VAT	£ Inc VAT
Oslo slimline basin unit	1.051	206.00	247.20
Bonito 60cm plinth (height 70mm)	1.037	14.00	16.80
Laminate Top Gloss 1000 x 310 mm	28.006	51.00	61.20



Pictured with Oslo Slimline semi-recessed furniture pg. 359 and Rimini accessories page 306-307

Metro Range

METRO SEMI RECESSED SLIM RIM BASIN



Cut out 260mm

METRO SLIM RIM SEMI RECESSED BASIN

Description	Code	£ Ex VAT	£ Inc VAT
Metro slim rim semi recessed basin	26.0097	81.00	97.20

METRO SLIM RIM BASIN

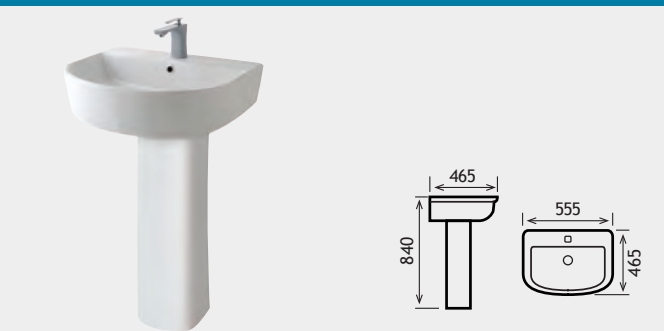

METRO SLIM RIM BASIN

Description	Code	£ Ex VAT	£ Inc VAT
Metro slim rim basin	26.0095	77.00	92.40
Metro slim rim pedestal	26.0096	39.00	46.80

METRO CC BTW PAN RANGE

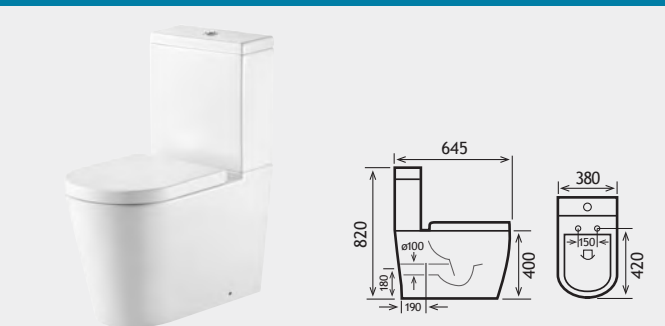

METRO SHORT PROJECTION CC BTW PAN

Description	Code	£ Ex VAT	£ Inc VAT
Metro short projection CC BTW Pan	26.0092	168.00	201.60
Metro short projection cistern	26.0094	67.00	80.40
Metro short projection soft close seat	26.0105	53.00	63.60
Jollytronic universal bottom entry cistern fitting	7.0000	99.00	118.80

METRO SHORT PROJECTION RIMLESS CC BTW PAN

Description	Code	£ Ex VAT	£ Inc VAT
Metro short projection rimless CC BTW Pan	26.0098	175.00	210.00
Metro short projection cistern	26.0094	67.00	80.40
Metro short projection soft close seat	26.0105	53.00	63.60
Jollytronic universal bottom entry cistern fitting	7.0000	99.00	118.80

METRO CC PAN RANGE

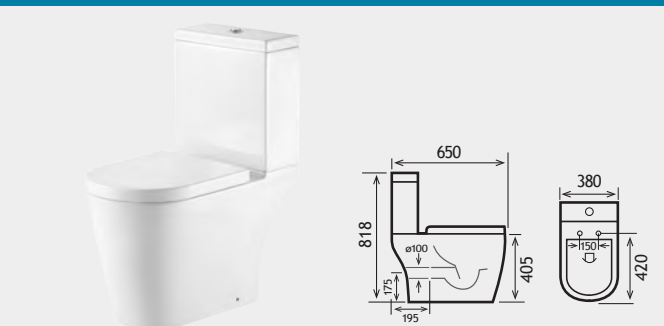

METRO SHORT PROJECTION CC PAN

Description	Code	£ Ex VAT	£ Inc VAT
Metro short projection CC Pan	26.0093	158.00	189.60
Metro short projection cistern	26.0094	67.00	80.40
Metro short projection soft close seat	26.0105	53.00	63.60
Jollytronic universal bottom entry cistern fitting	7.0000	99.00	118.80

METRO SHORT PROJECTION RIMLESS CC PAN

Description	Code	£ Ex VAT	£ Inc VAT
Metro short projection rimless CC Pan	26.0099	165.00	198.00
Metro short projection cistern	26.0094	67.00	80.40
Metro short projection soft close seat	26.0105	53.00	63.60

METRO HIGH LEVEL CC BTW PAN

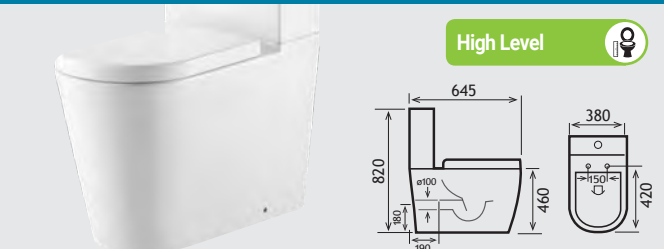

METRO HIGH LEVEL CC BTW PAN

Description	Code	£ Ex VAT	£ Inc VAT
Metro short projection high level CC BTW Pan	26.0101	193.00	231.60
Metro short projection cistern	26.0094	67.00	80.40
Metro short projection soft close seat	26.0105	53.00	63.60

METRO HIGH LEVEL RIMLESS CC BTW PAN

Description	Code	£ Ex VAT	£ Inc VAT
Metro short projection Rimless high level CC BTW Pan	26.0100	200.00	240.00
Metro short projection cistern	26.0094	67.00	80.40
Metro short projection soft close seat	26.0105	53.00	63.60

THIS METRO RANGE FEATURES RIMLESS TECHNOLOGY



EASY CLEAN - Nowhere for germs to hide.
AESTHETICS - Simplistic look.
EFFICIENT - A complete rim flush for effective cleaning.

Minima Range

MINIMA



Aimed at the bathroom, cloakroom or ensuite where space is at a premium, the Minima manages to combine style with space-saving qualities.

FEATURES

- Soft close seat
- BTW Soft close seat lifts off for easy cleaning
- Top fix seat
- Small minimalistic basin
- Basin fits with full or semi pedestal
- Soil can be turned left or right on close coupled pan

FEATURES - VANTAGE CISTERN

- WRAS approved flushing components
- Delay fill inlet valve - no water waste



Minima			
Description	Code	£ Ex VAT	£ Inc VAT
Minima pan & soft close seat*	56.0018	291.00	349.20
Minima cistern inc fittings	56.0020	84.00	100.80
Minima soft close seat	56.0019	83.00	99.60
Minima basin 1TH	56.0016	83.00	99.60
Minima pedestal	56.0017	60.00	72.00
Minima semi-pedestal for 56.0016	56.0067	56.00	67.20
Minima BTW pan c/w soft close seat	56.0068	269.00	322.80
Minima BTW soft close seat	56.0069	90.00	108.00
Minima semi-recessed reduced depth basin 1TH	56.0066	89.00	106.80
Jollytronic universal bottom entry cistern fitting	7.0000	99.00	118.80

Soil can be turned left or right on close coupled pan.
**For more information see page 245.

BTW Pan Extras			
Description	Code	£ Ex VAT	£ Inc VAT
Vantage Plain Hidden Cistern CP Push Button	17.001	133.00	159.60
Vantage Hidden Cistern with Jacket	17.3029	155.00	186.00
Eastbrook Jacket Hidden Cistern - Bottom Inlet	53.001	82.00	98.40
Flexible WC Connector for BTW Pans*	2.009	29.00	34.80

*Pan connector 2.009 is recommended for use with our BTW pans.

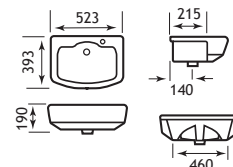
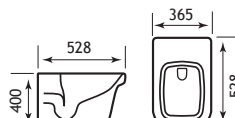
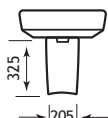
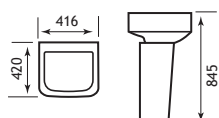
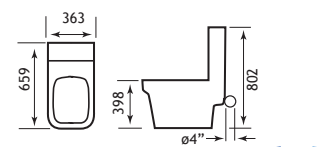

56.0020/56.0018 *Soil can be turned left or right at the back of the pan

56.0016/56.0017

56.0067

56.0068

56.0066 Cut out 215mm

Minima Range



Minima pan shown with Linea basin. For the rest of the Linea range see pages 202-203.



Minima pan shown with Metro basin. For the rest of the Metro range see pages 214-215.

Linea Basin

Description	Code	£ Ex VAT	£ Inc VAT
Linea basin 560mm 1TH	56.0011	95.00	114.00
Linea pedestal	56.0012	60.00	72.00

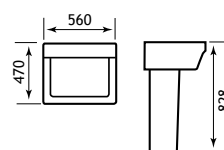

56.0011

Metro Basin

Description	Code	£ Ex VAT	£ Inc VAT
Metro basin 610mm 1TH	56.0026	116.00	139.20
Metro pedestal	56.0027	55.00	66.00

Clicker or flipper waste recommended

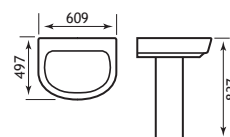

56.0026

Mentmore Range

MENTMORE



Soft Close Seat 

A modern design with stylish angled shapes create a beautiful contemporary bathroom

- FEATURES**
- Soft close seat

Mentmore Range

MENTMORE WC

Soft Close Seat 



26.0038

26.0036

26.0037

Mentmore WC

Description	Code	£ Ex VAT	£ Inc VAT
Mentmore WC Pan	26.0036	179.00	214.80
Mentmore Cistern inc Fittings	26.0037	77.00	92.40
Mentmore Soft Close Seat	26.0038	61.00	73.20

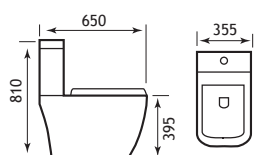

26.0036 / 26.0037

MENTMORE BASIN



26.0034

26.0035

Mentmore Basin

Description	Code	£ Ex VAT	£ Inc VAT
Mentmore Basin 1TH	26.0034	84.00	100.80
Mentmore Pedestal	26.0035	44.00	52.80

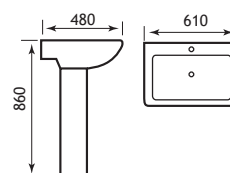

26.0034/26.0035

MODERN WATER SAVING OPTION
JOLLYTRONIC ECO FLUSH



Description	Code	£ Ex VAT	£ Inc VAT
Jollytronic universal bottom entry cistern fitting	7.0000	99.00	118.80

For more information see page 245.

Northall Range

NORTHALL PANS

A contemporary rimless pan in both close coupled and back to wall to suit a wide range of installations.

FEATURES

- Quick release soft close seat
- Rimless technology
- Top fix seat
- 2 styles of seat available

Northall High Level BTW CC Pan

Description	Code	£ Ex VAT	£ Inc VAT
Northall High Level BTW CC Rimless Pan*	26.0054	181.00	217.20
Northall Soft Close Seat	26.0042	66.00	79.20
Northall / Farringdon Wrap Over Soft Close Seat	26.0056	50.00	60.00
Jollytronic universal bottom entry cistern fitting	7.0000	99.00	118.80

*Compatible with both 26.0042 & 26.0056

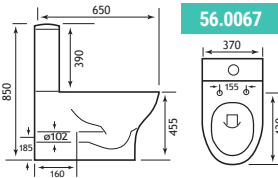

- Comfort Height
- Soft Close Seat
- Rimless Tech

Shown with 26.0042 seat.
Compatible with both 26.0056/26.0042

Northall High Level BTW

Description	Code	£ Ex VAT	£ Inc VAT
Northall High Level BTW Rimless Pan*	26.0055	192.00	230.40
Northall Soft Close Seat	26.0042	66.00	79.20
Northall / Farringdon Wrap Over Soft Close Seat	26.0056	50.00	60.00

*Compatible with both 26.0042 & 26.0056.
See page 223 for 26.0056.

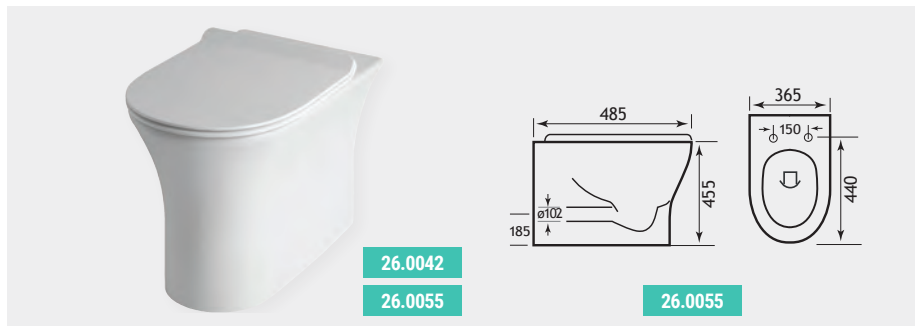

Northall BTW Pan

Description	Code	£ Ex VAT	£ Inc VAT
Northall BTW Rimless Pan*	26.0041	191.00	229.20
Northall Soft Close Seat	26.0042	66.00	79.20
Northall / Farringdon Wrap Over Soft Close Seat	26.0056	50.00	60.00

*Compatible with both 26.0042 & 26.0056.
See page 223 for 26.0056.

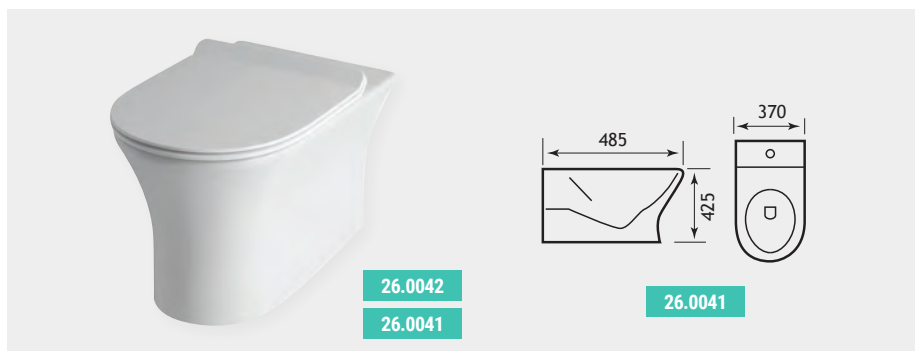

Northall Wall Hung Pan

Description	Code	£ Ex VAT	£ Inc VAT
Northall Wall Hung Rimless Pan*	26.0104	165.00	198.00
Northall Soft Close Seat	26.0042	66.00	79.20
Northall / Farringdon Wrap Over Soft Close Seat	26.0056	50.00	60.00

*Compatible with both 26.0042 & 26.0056.
See page 223 for 26.0056.

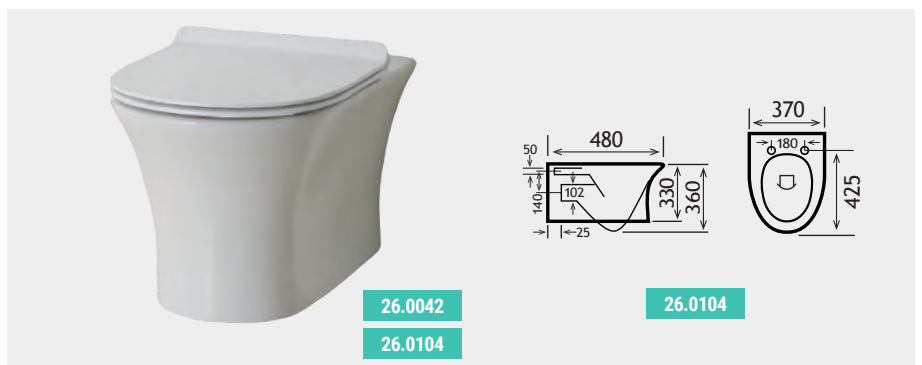

Northall Range

FEATURING Rimless Technology



Rimless Tech

- EASY CLEAN** - Nowhere for germs to hide.
- AESTHETICS** - Simplistic look.
- EFFICIENT** - A complete rim flush for effective cleaning.

Northall WC Pan

Description	Code	£ Ex VAT	£ Inc VAT
Northall WC Pan*	26.0039	187.00	224.40
Northall Cistern inc Fittings	26.0040	87.00	104.40
Northall Soft Close Seat	26.0042	66.00	79.20
Northall / Farringdon Wrap Over Soft Close Seat	26.0056	50.00	60.00
Jollytronic universal bottom entry cistern fitting	7.0000	99.00	118.80

*Compatible with both 26.0042 & 26.0056

NORTHALL WC PAN

Rimless Tech

26.0040 26.0056



Shown with 26.0056 seat.

26.0039

Modern Water Saving Option Jollytronic Eco Flush



CODE 7.0000
See page 245 for further technical information.

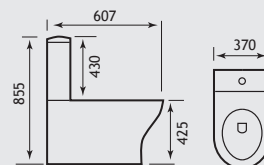

26.0039 / 26.0040

NORTHALL BASIN RANGE



Northall/Farringdon 450mm 1TH Basin

Description	Code	£ Ex VAT	£ Inc VAT
Farringdon 450mm 1TH basin	26.0064	49.00	58.80
Farringdon Semi ped	26.0065	41.00	49.20

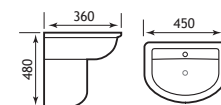

26.0064/26.0065

Northall/Farringdon 500mm 1TH Basin

Description	Code	£ Ex VAT	£ Inc VAT
Farringdon 500mm 1TH basin	26.0066	65.00	78.00
Farringdon Semi ped	26.0065	41.00	49.20

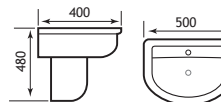

26.0066/26.0065

Northall/Farringdon 550mm 1TH Basin

Description	Code	£ Ex VAT	£ Inc VAT
Farringdon 550mm 1TH basin	26.0062	69.00	82.80
Farringdon Semi ped	26.0065	41.00	49.20

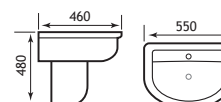

26.0062/26.0065



Northall/Farringdon 450mm 1TH Basin

Description	Code	£ Ex VAT	£ Inc VAT
Farringdon 450mm 1TH basin	26.0064	49.00	58.80
Farringdon Pedestal	26.0063	44.00	52.80

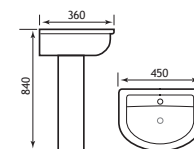

26.0064/26.0063

Northall/Farringdon 500mm 1TH Basin

Description	Code	£ Ex VAT	£ Inc VAT
Farringdon 500mm 1TH basin	26.0066	65.00	78.00
Farringdon Pedestal	26.0063	44.00	52.80

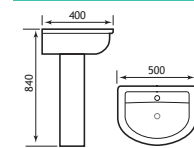

26.0066/26.0063

Northall/Farringdon 550mm 1TH Basin

Description	Code	£ Ex VAT	£ Inc VAT
Farringdon 550mm 1TH basin	26.0062	69.00	82.80
Farringdon Pedestal	26.0063	44.00	52.80

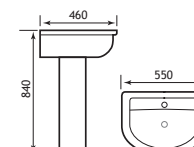

26.0062/26.0063

Pluton Range

PLUTON

30% OFF



An extensive range that combines a more traditional design of sanitaryware with modern specifications.

FEATURES

- Soft close seat
- Close coupled pan can have soil left or right
- Top fix seat
- 600mm basin can be fitted with full or semi ped

PLUTON WALL HUNG



Pluton Wall Hung	NOW JUST		
Description	Code	£ Ex VAT	£ Inc VAT
Pluton wall hung WC pan †	83.0008	84.00	100.80
Pluton soft close seat †	83.0007	84.00	100.80

†While stocks last

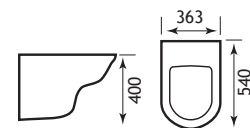

PLUTON BTW CC PAN



Pluton BTW CC Pan	NOW JUST		
Description	Code	£ Ex VAT	£ Inc VAT
Pluton fully BTW WC pan CC †	83.0002	119.00	142.80
Pluton cistern inc fittings †	83.0005	73.00	87.60
Pluton soft close seat †	83.0007	84.00	100.80
Jollytronic universal bottom entry cistern fitting	7.0000	99.00	118.80

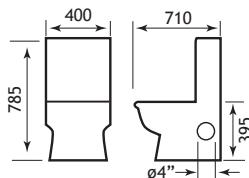

PLUTON SEMI PED BASIN



Pluton Basin	NOW JUST		
Description	Code	£ Ex VAT	£ Inc VAT
Pluton basin 600mm 1TH †	83.0011	59.00	70.80
Pluton semi pedestal †	83.0014	41.00	49.20

†While stocks last

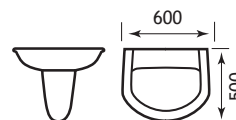

Pluton Range

PLUTON BASINS & PEDESTAL

WAS £79.00
NOW JUST **£55.00**

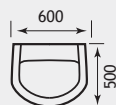

83.0011

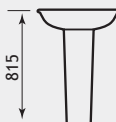
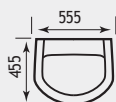

83.0010/12

Pluton Basins		WAS	NOW JUST	
Description	Code	£ Ex VAT	£ Ex VAT	£ Inc VAT
Pluton basin 555mm 1TH †	83.0010	79.00	55.00	66.00
Pluton basin 600mm 1TH †	83.0011	84.00	59.00	70.80
Pluton pedestal †	83.0012	61.00	43.00	51.60

†While stocks last

PLUTON CLOSE COUPLED PAN

WAS £104.00
NOW JUST **£73.00**

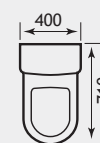
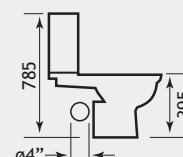

Pluton Close Coupled Pan		WAS	NOW JUST	
Description	Code	£ Ex VAT	£ Ex VAT	£ Inc VAT
Pluton WC pan close coupled †	83.0004	191.00	134.00	160.80
Pluton cistern inc fittings †	83.0005	104.00	73.00	87.60
Pluton soft close seat †	83.0007	119.00	84.00	100.80
Jollytronic universal bottom entry cistern fitting	7.0000	-	99.00	118.80

PLUTON SEMI RECESSED BASIN

WAS £83.00
NOW JUST **£58.00**



Cut out 270mm

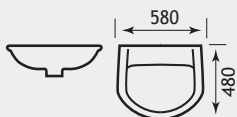

Pluton Semi Recessed Basin		WAS	NOW JUST	
Description	Code	£ Ex VAT	£ Ex VAT	£ Inc VAT
Pluton semi recessed basin 1TH †	83.0015	83.00	58.00	69.60

†While stocks last

PLUTON BTW PAN

WAS £119.00
NOW JUST **£104.00**

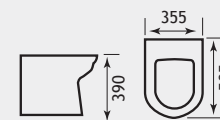

Pluton BTW Pan		WAS	NOW JUST	
Description	Code	£ Ex VAT	£ Ex VAT	£ Inc VAT
Pluton BTW WC pan †	83.0003	149.00	104.00	124.80
Pluton soft close seat †	83.0007	119.00	84.00	100.80

BTW Pan Extras			
Description	Code	£ Ex VAT	£ Inc VAT
Vantage Plain Hidden Cistern CP Push Button	17.001	133.00	159.60
Vantage Hidden Cistern with Jacket	17.3029	155.00	186.00
Eastbrook Jacket Hidden Cistern - Bottom Inlet	53.001	82.00	98.40
Flexible WC Connector for BTW Pans*	2.009	29.00	34.80

*Pan connector 2.009 is recommended for use with our BTW pans.

†While stocks last

Quadro Range

QUADRO



Linea Basin
For the rest of the Linea range see pages 202-203



Metro Basin
For the rest of the Metro range see pages 214-215.

The square design of the Quadro is the latest styling in contemporary living and offers a distinctive look which will grace any modern bathroom.

FEATURES

- Soft close seat, lifts off for easy cleaning
- Spacious basin at 632mm wide
- Quadro pan matches a variety of basins
- Top fix seat

Quadro

Description	Code	£ Ex VAT	£ Inc VAT
Quadro pan & soft close seat†	56.0079	321.00	385.20
Quadro cistern inc fittings†	56.0025	88.00	105.60
Jollytronic universal bottom entry cistern fitting**	7.0000	99.00	118.80

**For more information see page 245. †While stocks last.

Alternative Basins To Match Quadro Pan

Description	Code	£ Ex VAT	£ Inc VAT
Linea basin 560mm 1TH	56.0011	95.00	114.00
Linea pedestal	56.0012	60.00	72.00
Metro basin 610mm 1TH	56.0026	116.00	139.20
Metro pedestal	56.0027	55.00	66.00
Ultima basin 590mm 1TH	56.0001	89.00	106.80
Ultima pedestal	56.0002	53.00	63.60

Clicker or flipper waste recommended.



56.0079 / 56.0025

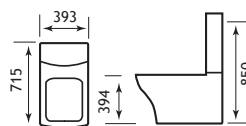

56.0026/27

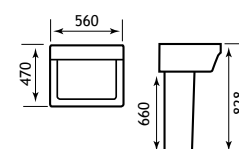

56.0011/12

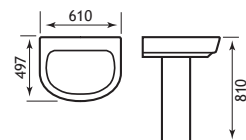

56.0026/27

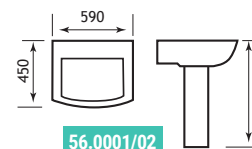

56.0001/02

Quba Range

QUBA



With strong, clean lines, Quba's bold, angular design makes it the ideal suite for the most contemporary of bathrooms.

FEATURES

- Soft close seat, lifts off for easy cleaning
- Soil can be turned left or right

FEATURES - VANTAGE CISTERN

- WRAS approved flushing components
- Delay fill inlet valve - no water waste

Quba Pan

Description	Code	£ Ex VAT	£ Inc VAT
Quba pan & soft close seat†	56.0033	269.00	322.80
Quba cistern†	56.0035	99.00	118.80
Jollytronic universal bottom entry cistern fitting**	7.0000	99.00	118.80

**For more information see page 245. †While stocks last.

*Soil can be turned left or right at the back of the pan

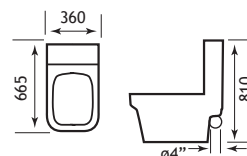

56.0033/35

Tamarind Range

TAMARIND



Elegant and classic with a striking period design, the Tamarind range is the perfect complement for the more traditional home.

FEATURES

- Soft close seat, lifts off for easy cleaning
- Cistern inlet left or right
- Available as lever or push button flush
- Soil can be turned left or right at back of pan

Tamarind Corner Basin

Description	Code	£ Ex VAT	£ Inc VAT
Tamarind corner Basin	26.0024	78.00	93.60

TAMARIND CORNER BASIN

26.0024



26.0024

Tamarind Range



Seat for illustration purposes only.

TAMARIND CORNER BASIN

26.0019

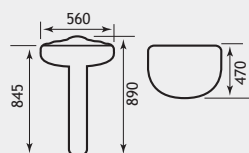

Tamarind Corner Basin

Description	Code	£ Ex VAT	£ Inc VAT
Tamarind 560 basin 1TH	26.0019	81.00	97.20
Tamarind 560 basin 2TH	26.0020	81.00	97.20
Tamarind pedestal	26.0021	46.00	55.20



26.0021

TAMARIND CLOSE COUPLED WC

26.0016/26.0017

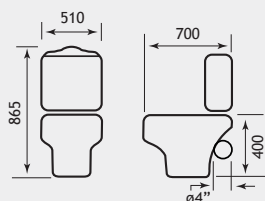

26.0016/26.0018

*Soil can be turned left or right at the back of the pan

Tamarind Close Coupled WC

Description	Code	£ Ex VAT	£ Inc VAT
Tamarind WC Pan	26.0016	136.00	163.20
Tamarind cistern inc lever flush fittings	26.0018	93.00	111.60
Tamarind cistern inc push button fittings	26.0017	82.00	98.40
Loire soft close seat	50.002	96.00	115.20
Jollytronic universal bottom entry cistern fitting**	7.0000	99.00	118.80

**Jollytronic cistern fitting will only fit 26.0017, for more information see page 245. Sherwood/Diamante standard and soft close seats are also suitable for the Tamarind pan but cannot be fitted with lever cistern, seat rests on lever when in upright position.



TAMARIND BASIN

26.0022

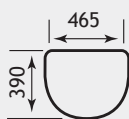

26.0022

Tamarind Basin

Description	Code	£ Ex VAT	£ Inc VAT
Tamarind basin 465 1TH	26.0022	62.00	74.40
Tamarind basin 465 2TH	26.0023	62.00	74.40



Temptation Range

TEMPTATION



From the minute that you set eyes on the stylish lines of this suite you will be tempted. The easy-to-clean lines of the WC suite and the elegant, sweeping style of the basin make the Temptation the perfect addition to any bathroom.

FEATURES

- Soft close seat, lifts off for easy cleaning
- Soil can be turned left or right
- Top fix seat

Temptation Wall Mounted Basin

Description	Code	£ Ex VAT	£ Inc VAT
Temptation basin 450 1TH	27.0721	68.00	81.60

Wall mounted only.

TEMPTATION WALL MOUNTED BASIN

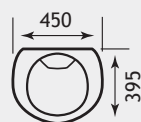

27.0721



Temptation Range

TEMPTATION BASIN 400

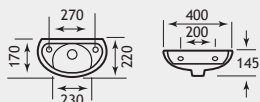

27.9711

Temptation Basin

Description	Code	£ Ex VAT	£ Inc VAT
Temptation basin 400 1TH	27.0781	58.00	69.60
Temptation basin 400 2TH	27.9711	58.00	69.60

Wall mounted only.

TEMPTATION PAN



27.0431

Temptation WC

Description	Code	£ Ex VAT	£ Inc VAT
Temptation pan	27.0431	130.00	156.00
Temptation cistern inc fittings	27.0441	78.00	93.60
Temptation/Kompact seat	21.1141	53.00	63.60
Temptation/Kompact soft close seat	21.1151	111.00	133.20
Jollytronic universal bottom entry cistern fitting†	7.0000	99.00	118.80

†For more information see page 245.

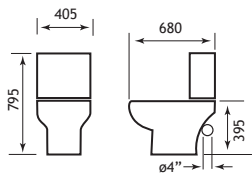

27.0431/27.0441

*Soil can be turned left or right at the back of the pan

TEMPTATION BASIN 500

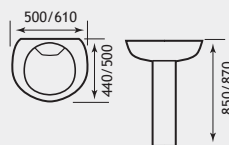

27.0461/27.0731

Temptation Basin

Description	Code	£ Ex VAT	£ Inc VAT
Temptation basin 500 1TH**	27.0731	72.00	86.40
Temptation basin 610mm 1TH	27.0521	81.00	97.20
Temptation pedestal (Fits both above)	27.0461	37.00	44.40

**Can be wall-hung or mounted on a pedestal.

TEMPTATION BASIN 575

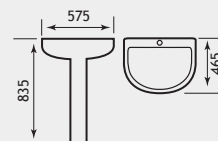

27.0451/27.0461

Temptation Basin

Description	Code	£ Ex VAT	£ Inc VAT
Temptation basin 575mm 1TH	27.0451	92.00	110.40
Temptation pedestal	27.0461	37.00	44.40

Ultima Range

ULTIMA



Ultima Range



The contemporary look of the Ultima with its clean, angular lines is a stylish addition to any bathroom

FEATURES

- Soft close seat, lifts off for easy cleaning
- Top fix seat

Ultima			
Description	Code	£ Ex VAT	£ Inc VAT
Ultima basin 590mm 1TH	56.0001	89.00	106.80
Ultima pedestal	56.0002	53.00	63.60
Ultima pan & soft close seat	56.0003	277.00	332.40
Ultima cistern inc fittings	56.0005	117.00	140.40
Ultima soft close seat	56.0004	83.00	99.60
Jollytronic universal bottom entry cistern fitting	7.0000	99.00	118.80

Extras			
Description	Code	£ Ex VAT	£ Inc VAT
Fabriano 700 x 500mm LED Landscape Mirror	40.1004	242.00	290.40
Hooper mono basin c/w clicker waste	56.2045	100.00	120.00

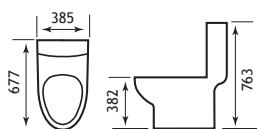

56.0003/ 56.0005

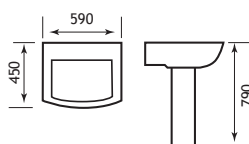

56.0001/ 56.0002



Wingrave Range

WINGRAVE



Pictured with Wingrave multirail see page 502-503 for full range

Stylish and adaptable, Wingrave combines elegant straight lines with soft curves to stunning effect.

FEATURES

- Soft close seat, lifts off for easy cleaning
- Basin fits full and semi pedestals
- Top fix seat
- Soil can be turned left or right

Wingrave

Description	Code	£ Ex VAT	£ Inc VAT
Wingrave basin 550mm 1TH†	56.0046	93.00	111.60
Wingrave pedestal	56.0047	51.00	61.20
Wingrave semi-recessed basin 1TH	56.0070	89.00	106.80
Wingrave pan & soft close seat	56.0048	261.00	313.20
Wingrave cistern	56.0050	99.00	118.80
Wingrave soft close seat	56.0049	69.00	82.80
Wingrave semi-pedestal for 56.0046	56.0071	59.00	70.80
Wingrave BTW pan c/w soft close seat	56.0072	244.00	292.80
Wingrave BTW soft close seat	56.0073	82.00	98.40
Flexible WC Connector for BTW Pans	2.009	29.00	34.80
Jollytronic universal bottom entry cistern fitting**	7.0000	99.00	118.80

** For more information see page 245.
† Clicker or flipper waste recommended

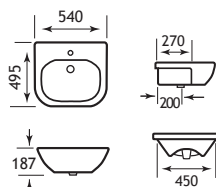

56.0070 Cut out 270mm

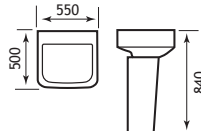

56.0046/ 56.0047

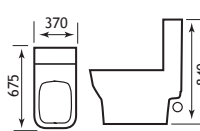

56.0048/ 56.0050

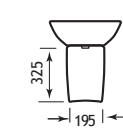

56.0046/ 56.0071

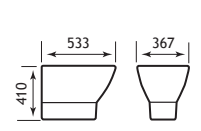

56.0072

Wingrave Range



BTW Pan Extras			
Description	Code	£ Ex VAT	£ Inc VAT
Vantage Plain Hidden Cistern CP Push Button	17.001	133.00	159.60
Vantage Hidden Cistern with Jacket	17.3029	155.00	186.00
Eastbrook Jacket Hidden Cistern - Bottom Inlet	53.001	82.00	98.40
Flexible WC Connector for BTW Pans*	2.009	29.00	34.80

*Pan connector 2.009 is recommended for use with our BTW pans.

- FEATURES - VANTAGE CISTERN**
- WRAS approved flushing components
 - Delay fill inlet valve - no water waste

Accessories			
Description	Code	£ Ex VAT	£ Inc VAT
Treviso 500 x 700mm LED Portrait Mirror	40.1002	170.00	204.00
Genoa tumbler holder	52.002	17.00	20.40
Genoa glass soap dispenser	52.004	30.00	36.00
Cortauld mono basin c/w clicker waste	56.2040	121.00	145.20

Sit on Basins

RENATA - SIT ON BASIN 430



Renata sit on basin

Description	Code	£ Ex VAT	£ Inc VAT
Renata sit on basin 430**	51.029	132.00	158.40
Trap for external overflow kit	7.0015	16.00	19.20
Flip Top Basin Waste - Unslotted	25.0005	12.00	14.40

**NB Renata also requires a 7.0015 trap and unslotted chrome waste 25.0005.

FEATURES

- Made of 75% natural marble stone
- Repairable if chipped
- Seamless surface, easy to maintain



RONDO - SIT ON BASIN 412



Rondo

Description	Code	£ Ex VAT	£ Inc VAT
Rondo sit on basin 412	51.032	147.00	176.40
Flip Top Basin Waste - Unslotted	25.0005	12.00	14.40

Basin requires an unslotted waste 25.0005

PRICILLA - SIT ON BASIN 510



Pricilla sit on basin

Description	Code	£ Ex VAT	£ Inc VAT
Pricilla sit on basin 510x300	51.031	147.00	176.40
Flip Top Basin Waste - Unslotted	25.0005	12.00	14.40



51.031

NATURA - SIT ON BASIN 500

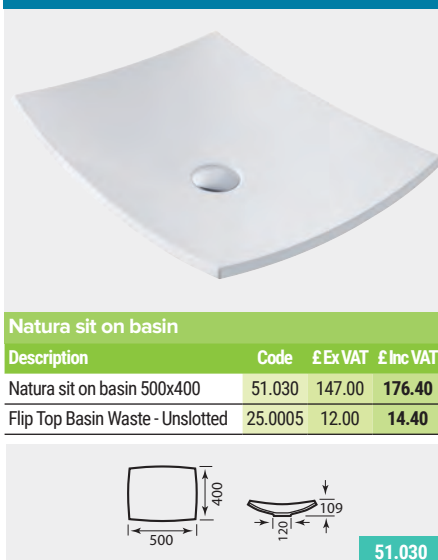

Natura sit on basin

Description	Code	£ Ex VAT	£ Inc VAT
Natura sit on basin 500x400	51.030	147.00	176.40
Flip Top Basin Waste - Unslotted	25.0005	12.00	14.40

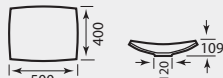

51.030

BARBRO - SIT ON BASIN 460



Barbro sit on basin

Description	Code	£ Ex VAT	£ Inc VAT
Barbro sit on basin 460	51.033	223.00	267.60
Flip Top Basin Waste - Unslotted	25.0005	12.00	14.40



51.033

Cloakroom Basins

SORRENTO WALL HUNG BASINS



All Sorrento basins offer a flexible design option for numerous modern applications.

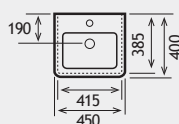

26.0088

Sorrento 45 (450mm x 397mm)

Description	Code	£ Ex VAT	£ Inc VAT
Sorrento 45cm Ceramic top	26.0088	74.00	88.80
Ceramic Top Basin Slotted Waste	45.0000	17.00	20.40

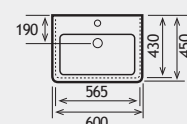

26.0089

Sorrento 60 (600mm x 445mm)

Description	Code	£ Ex VAT	£ Inc VAT
Sorrento 60cm Ceramic top	26.0089	96.00	115.20
Ceramic Top Basin Slotted Waste	45.0000	17.00	20.40

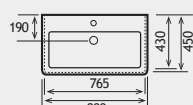

26.0090

Sorrento 80 (800mm x 445mm)

Description	Code	£ Ex VAT	£ Inc VAT
Sorrento 80cm Ceramic Top	26.0090	124.00	148.80
Ceramic Top Basin Slotted Waste	45.0000	17.00	20.40

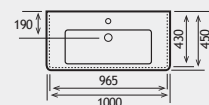

83.0020

Sorrento 100 (1000mm x 445mm)

Description	Code	£ Ex VAT	£ Inc VAT
Sorrento 100cm ceramic top	83.0020	142.00	170.40
Ceramic Top Basin Slotted Waste	45.0000	17.00	20.40

CLOAKROOM WALL HUNG BASINS

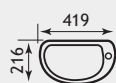

Kompact Cloakroom Basin

Description	Code	£ Ex VAT	£ Inc VAT
Kompact cloakroom basin 419x216 1TH RH	27.0381	46.00	55.20

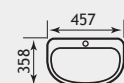

Kompact Basin

Description	Code	£ Ex VAT	£ Inc VAT
Kompact Basin 457mm 1TH	27.0401	62.00	74.40



Kompact Cloakroom Basin

Description	Code	£ Ex VAT	£ Inc VAT
Kompact cloakroom basin 509x216 1TH RH	27.0391	50.00	60.00

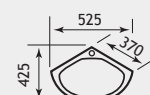

Tamarind Corner Basin

Description	Code	£ Ex VAT	£ Inc VAT
Tamarind corner Basin	26.0024	78.00	93.60

Cloakroom Basins

CLOAKROOM BASINS

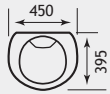

Temptation			
Description	Code	£ Ex VAT	£ Inc VAT
Temptation basin 450 1TH	27.0721	68.00	81.60

Wall mounted only.

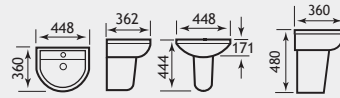

26.0005 26.0004/5 26.0004/26



26.0026

Dura			
Description	Code	£ Ex VAT	£ Inc VAT
Dura semi pedestal inc fixings	26.0004	33.00	39.60
Dura basin 450mm 1th inc fixings	26.0005	41.00	49.20
Dura basin 450mm 2TH inc Fixings	26.0026	45.00	54.00

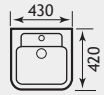

Andelle			
Description	Code	£ Ex VAT	£ Inc VAT
Andelle 430mm 1TH Basin	24.0010	45.00	54.00

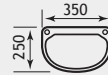

Loire 350 x 250 cloakroom basin			
Description	Code	£ Ex VAT	£ Inc VAT
Loire 350 x 250 cloakroom basin 1TH RH	75.0008	49.00	58.80
Loire 350 x 250 cloakroom basin 2TH	75.0018	49.00	58.80

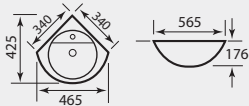

Dura Corner Basin			
Description	Code	£ Ex VAT	£ Inc VAT
460mm 1TH inc fixings	26.0013	45.00	54.00

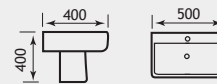

Crowthorne			
Description	Code	£ Ex VAT	£ Inc VAT
Crowthorne Semi Pedestal	26.0030	39.00	46.80
Crowthorne Basin 500mm 1TH	26.0029	81.00	97.20

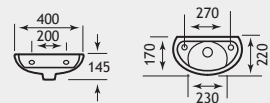

Temptation			
Description	Code	£ Ex VAT	£ Inc VAT
Temptation basin 400 1TH*	27.0781	58.00	69.60
Temptation basin 400 2TH	27.9711	58.00	69.60

*RH tap hole. Both are wall mounted only.

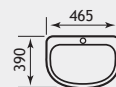

Tamarind			
Description	Code	£ Ex VAT	£ Inc VAT
Tamarind basin 465 1TH	26.0022	62.00	74.40
Tamarind basin 465 2TH	26.0023	62.00	74.40

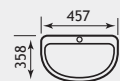

Cloakroom			
Description	Code	£ Ex VAT	£ Inc VAT
Cloakroom basin 457x358 1TH	56.0051	89.00	106.80

*Due December 2019

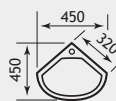

Kompact Corner			
Description	Code	£ Ex VAT	£ Inc VAT
Kompact corner cloakroom basin 1TH	27.0371	71.00	85.20

Cloakroom Basins

CLOAKROOM BASINS



Cloakroom Basin			
Description	Code	£ Ex VAT	£ Inc VAT
Cloakroom basin 457x358 2TH	56.0052	89.00	106.80
Cloakroom basin 509x240 1TH	56.0053	89.00	106.80
Cloakroom basin 509x240 2TH	56.0054	89.00	106.80



Cloakroom Basin			
Description	Code	£ Ex VAT	£ Inc VAT
Cloakroom basin 419x216 1TH	56.0056	87.00	104.40
Cloakroom basin 419x216 2TH	56.0057	87.00	104.40

*Due December 2019

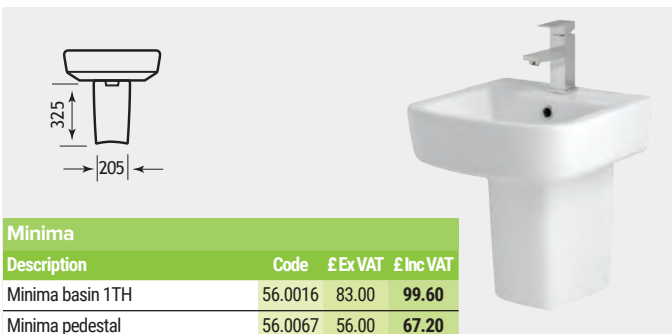

Minima			
Description	Code	£ Ex VAT	£ Inc VAT
Minima basin 1TH	56.0016	83.00	99.60
Minima pedestal	56.0067	56.00	67.20



Corner basin			
Description	Code	£ Ex VAT	£ Inc VAT
Corner basin 450mm 1TH	56.0055	91.00	109.20

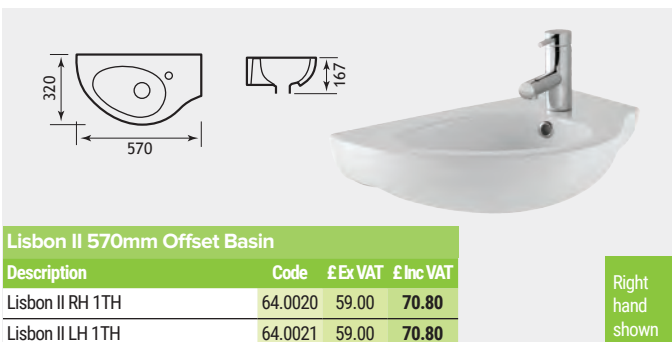

Lisbon II 570mm Offset Basin			
Description	Code	£ Ex VAT	£ Inc VAT
Lisbon II RH 1TH	64.0020	59.00	70.80
Lisbon II LH 1TH	64.0021	59.00	70.80

Right hand shown

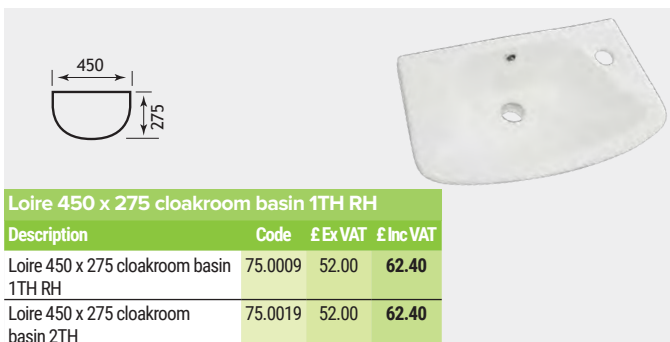

Loire 450 x 275 cloakroom basin 1TH RH			
Description	Code	£ Ex VAT	£ Inc VAT
Loire 450 x 275 cloakroom basin 1TH RH	75.0009	52.00	62.40
Loire 450 x 275 cloakroom basin 2TH	75.0019	52.00	62.40

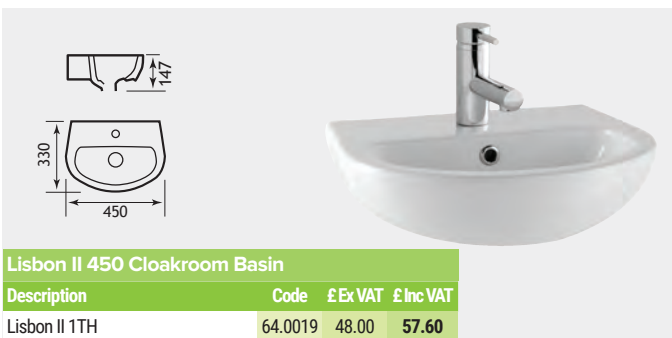

Lisbon II 450 Cloakroom Basin			
Description	Code	£ Ex VAT	£ Inc VAT
Lisbon II 1TH	64.0019	48.00	57.60



Lisbon II 240 x 520 Cloakroom Basin			
Description	Code	£ Ex VAT	£ Inc VAT
Lisbon II 1TH	64.0018	52.00	62.40

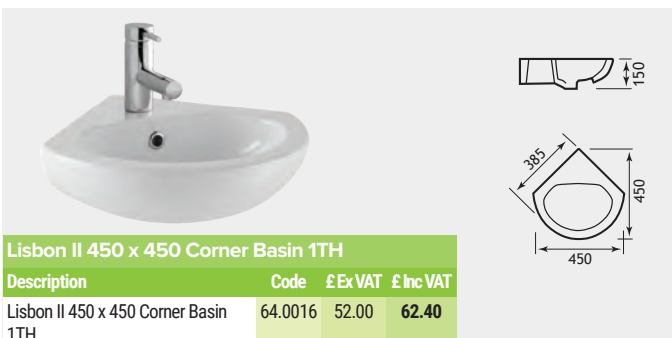

Lisbon II 450 x 450 Corner Basin 1TH			
Description	Code	£ Ex VAT	£ Inc VAT
Lisbon II 450 x 450 Corner Basin 1TH	64.0016	52.00	62.40

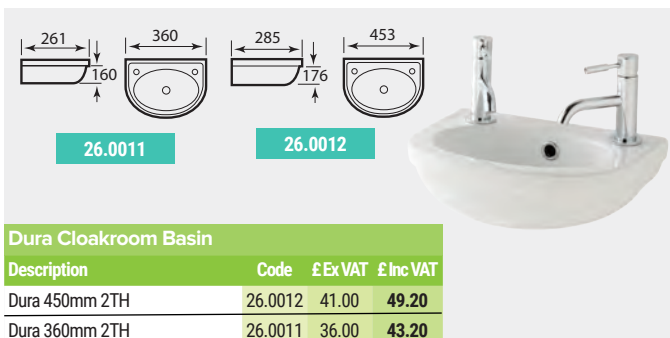

Dura Cloakroom Basin			
Description	Code	£ Ex VAT	£ Inc VAT
Dura 450mm 2TH	26.0012	41.00	49.20
Dura 360mm 2TH	26.0011	36.00	43.20

Inset Vanity Basins

INSET VANITY BASINS



Pat Inset			
Description	Code	£ Ex VAT	£ Inc VAT
Pat inset basin basin 500x369	51.034	105.00	126.00



Osanna			
Description	Code	£ Ex VAT	£ Inc VAT
Osanna inset basin 500x370	51.028	105.00	126.00

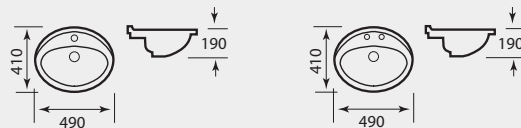

Inset Vanity Basin			
Description	Code	£ Ex VAT	£ Inc VAT
Inset Vanity basin 1TH	26.0052	66.00	79.20
Inset vanity basin 2TH *	26.0053	66.00	79.20

*No chain stay

SEMI-RECESSED VANITY BASINS



Arkitekt			
Description	Code	£ Ex VAT	£ Inc VAT
Arkitekt semi-recessed vanity basin 1TH	10.018	102.00	122.40



Bijou			
Description	Code	£ Ex VAT	£ Inc VAT
Bijou Semi Recessed basin	26.0076	86.00	103.20



Loire			
Description	Code	£ Ex VAT	£ Inc VAT
Loire Semi-Recessed basin 1TH	75.0006	95.00	114.00
Loire Semi-Recessed Basin 2TH	75.0016	95.00	114.00



Pluton			
Description	Code	WAS	NOW JUST
Pluton semi recessed basin 1TH	83.0015	£83.00	£58.00

Semi-Recessed Basins

SEMI-RECESSED VANITY BASINS



Metro			
Description	Code	£ Ex VAT	£ Inc VAT
Metro semi-recessed basin 1TH	56.0064	99.00	118.80

Clicker or flipper waste recommended for 56 code basins.



Minima			
Description	Code	£ Ex VAT	£ Inc VAT
Minima semi-recessed reduced depth basin 1TH	56.0066	89.00	106.80

Clicker or flipper waste recommended for 56 code basins.



Colorado			
Description	Code	£ Ex VAT	£ Inc VAT
Colorado semi recessed basin 1TH	64.0026	113.00	135.60



Dura			
Description	Code	£ Ex VAT	£ Inc VAT
Dura semi recessed basin 1TH	26.0009	51.00	61.20



Kompact			
Description	Code	£ Ex VAT	£ Inc VAT
Kompact reduced depth SR basin 1TH LH	27.0361	84.00	100.80
Kompact reduced depth SR basin 2TH	27.9361	84.00	100.80

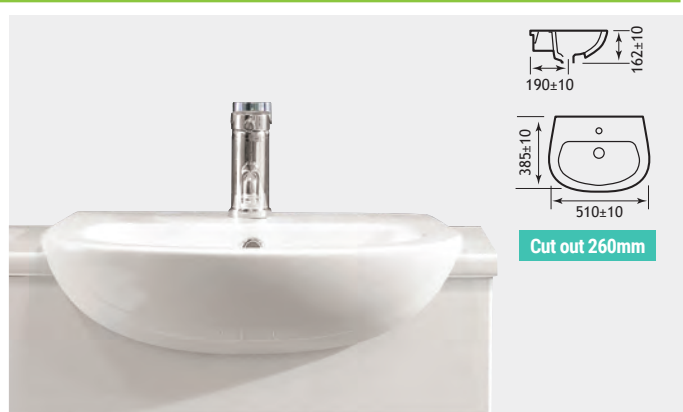

Lisbon II			
Description	Code	£ Ex VAT	£ Inc VAT
Lisbon II Semi Recessed Basin 1TH	64.0022	71.00	85.20



Metro Slim Rim			
Description	Code	£ Ex VAT	£ Inc VAT
Metro slim rim semi recessed basin	26.0097	81.00	97.20



Wingrave			
Description	Code	£ Ex VAT	£ Inc VAT
Wingrave semi-recessed basin 1TH	56.0070	89.00	106.80

Clicker or flipper waste recommended for 56 code basins.

Back to Wall Pans

COLLINDALE

Comfort Height 

Soft Close Seat 

Rimless Tech 

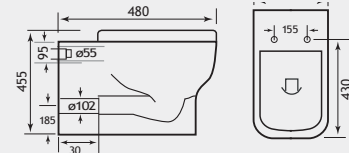

Description	Code	£ Ex VAT	£ Inc VAT
Collindale Rimless Comfort Height BTW Pan	26.0068	177.00	212.40
Bijou/Collindale Soft close seat	26.0070	56.00	67.20
Flexible Connector for BTW Pans	2.009	29.00	34.80

NORTHALL

Comfort Height 

Soft Close Seat 

Rimless Tech 

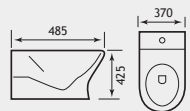

26.0041 / 26.0042

Description	Code	£ Ex VAT	£ Inc VAT
Northall BTW Pan	26.0041	191.00	229.20
Northall Soft Close Seat	26.0042	66.00	79.20
Northall High Level BTW	26.0055	192.00	230.40
Northall / Farringdon Wrap Over Soft Close Seat	26.0056	50.00	60.00

KOMPACT

Soft Close Seat 

FEATURES
• Top Fix Seat

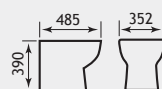

Description	Code	£ Ex VAT	£ Inc VAT
Kompact BTW pan**	27.0321	120.00	144.00
Temptation/Kompact seat	21.1141	53.00	63.60
Temptation/Kompact soft close seat	21.1151	111.00	133.20
Flexible Connector for BTW Pans	2.009	29.00	34.80

**Pan connector 2.009 is recommended for use with our BTW pan.

COLORADO

FEATURES
• Top Fix Seat

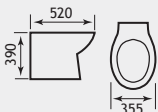

Description	Code	£ Ex VAT	£ Inc VAT
Colorado BTW WC pan**	64.0001	94.00	112.80
Colorado seat	64.0003	35.00	42.00
Colorado soft close seat	50.006	83.00	99.60
Flexible Connector for BTW Pans	2.009	29.00	34.80

**Pan connector 2.009 is recommended for use with our BTW pan.

WINGRAVE

Soft Close Seat 

FEATURES
• Top Fix Seat

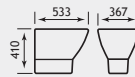

Description	Code	£ Ex VAT	£ Inc VAT
Wingrave BTW pan c/w soft close seat**	56.0072	244.00	292.80
Wingrave BTW c/w soft close seat	56.0073	82.00	98.40
Flexible Connector for BTW Pans	2.009	29.00	34.80

**Pan connector 2.009 is recommended for use with our BTW pan.

BIJOU

Soft Close Seat 

Rimless Tech 

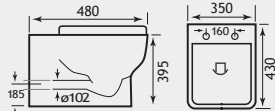

Description	Code	£ Ex VAT	£ Inc VAT
Bijou BTW Pan	26.0073	144.00	172.80
Bijou Rimless BTW Pan	26.0084	144.00	172.80
Bijou/Collindale Soft close seat	26.0070	56.00	67.20
Flexible Connector for BTW Pans	2.009	29.00	34.80

METRO

Soft Close Seat 

FEATURES
• Top Fix Seat

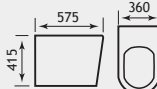

Description	Code	£ Ex VAT	£ Inc VAT
Metro BTW Pan & soft close seat**	56.0058	322.00	386.40
Metro BTW pan soft close seat	56.0060	75.00	90.00
Flexible Connector for BTW Pans	2.009	29.00	34.80

**Pan connector 2.009 is recommended for use with our BTW pan.

PLUTON

Soft Close Seat 

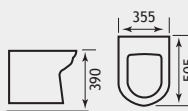

Description	Code	£ Ex VAT	£ Inc VAT
Pluton BTW WC pan**	83.0003	104.00	124.80
Pluton soft close seat	83.0007	84.00	100.80
Flexible Connector for BTW Pans	2.009	29.00	34.80

**Pan connector 2.009 is recommended for use with our BTW pan.

Back to Wall Pans

MINIMA

Soft Close Seat 

FEATURES
• Top Fix Seat

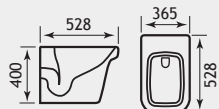

Description	Code	£ Ex VAT	£ Inc VAT
Minima BTW pan c/w soft close seat**	56.0068	269.00	322.80
Minima BTW soft close seat	56.0069	90.00	108.00
Flexible Connector for BTW Pans	2.009	29.00	34.80

**Pan connector 2.009 is recommended for use with our BTW pan.

DURA

Soft Close Seat 

FEATURES
• Top Fix Seat



26.0008

Description	Code	£ Ex VAT	£ Inc VAT
Dura BTW Pan inc fixings	26.0008	81.00	97.20
Dura High Level BTW Pan	26.0047	134.00	160.80
Dura deluxe soft close seat	26.0015	49.00	58.80

ARKITECT

Soft Close Seat 

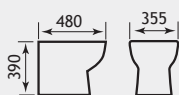

Description	Code	£ Ex VAT	£ Inc VAT
Arkitekt BTW WC pan	10.017	111.00	133.20
Loire/Arkitekt deluxe seat	50.001	34.00	40.80
Loire soft close seat	50.002	96.00	115.20
Flexible Connector for BTW Pans	2.009	29.00	34.80

**Pan connector 2.009 is recommended for use with our BTW pan.

LOIRE

Soft Close Seat 

FEATURES
• Top Fix Seat

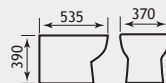

Description	Code	£ Ex VAT	£ Inc VAT
Loire BTW WC pan & Fixing Bolts**	75.0010	126.00	151.20
Rhone soft close seat	40.0001	57.00	68.40
Flexible Connector for BTW Pans	2.009	29.00	34.80

**Pan connector 2.009 is recommended for use with our BTW pan.

FARRINGDON

Soft Close Seat 

Rimless Tech 

FEATURES
• High Level

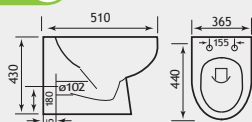

Description	Code	£ Ex VAT	£ Inc VAT
Farringdon BTW pan	26.0058	147.00	176.40
Northall / Farringdon Wrap Over Soft Close Seat	26.0056	50.00	60.00
Farringdon Rimless BTW pan	26.0079	147.00	176.40
Flexible Connector for BTW Pans	2.009	29.00	34.80

ANJOU

Comfort Height 

Soft Close Seat 

FEATURES
• Top Fix Seat
• High Level

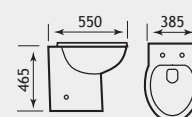

Description	Code	£ Ex VAT	£ Inc VAT
Anjou High Level BTW pan†	75.0013	270.00	324.00
Rhone soft close seat	40.0001	57.00	68.40

†Anjou can only be fitted to tall cistern unit or a wall. See page 353 for compatibility.

LISBON II

Soft Close Seat 

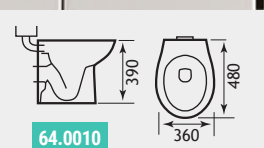

64.0010



Description	Code	£ Ex VAT	£ Inc VAT
Lisbon II BTW Pan	64.0010	104.00	124.80
Lisbon II BTW & Corner Pan Seat	64.0011	30.00	36.00
Lisbon II BTW & Corner Pan Soft Close Seat	64.0025	77.00	92.40
Lisbon II Semi Recessed Basin 1TH	64.0022	71.00	85.20
Flexible Connector for BTW Pans	2.009	29.00	34.80

**Pan connector 2.009 is recommended for use with our BTW pan.

Wall Hung Pans

SEINE

Soft Close Seat 

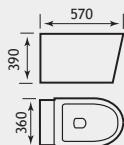

Description	Code	£ Ex VAT	£ Inc VAT
Seine Wall Hung WC Pan**	40.0004	142.00	170.40
Seine Wall Hung WC Soft Close Seat	40.0005	36.00	43.20

** Requires either wall-hung bracket or frame - See page 246.

SOMME

Soft Close Seat 

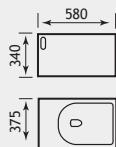

Description	Code	£ Ex VAT	£ Inc VAT
Somme Wall Hung WC Pan**	40.0008	183.00	219.60
Somme Wall Hung WC Soft Close Seat	40.0009	36.00	43.20

** Requires either wall-hung bracket or frame - See page 246.

LISBON II

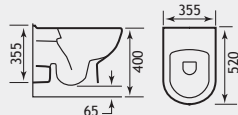

Description	Code	£ Ex VAT	£ Inc VAT
Lisbon II Wall Hung WC Pan	64.0008	125.00	150.00
Lisbon II Soft Close Seat	64.0009	63.00	75.60

BIJOU

Soft Close Seat 

Rimless Tech 

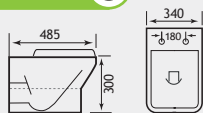

Description	Code	£ Ex VAT	£ Inc VAT
Bijou Wall Hung Pan†	26.0072	152.00	182.40
Bijou/Collindale Soft close seat	26.0070	56.00	67.20
Bijou Rimless Wall Hung Pan	26.0083	152.00	182.40

MOSELLE

Soft Close Seat 

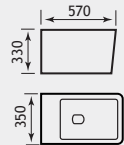

Description	Code	£ Ex VAT	£ Inc VAT
Moselle Wall Hung WC Pan**	40.0006	142.00	170.40
Moselle Wall Hung WC Soft Close Seat	40.0007	36.00	43.20

** Requires either wall-hung bracket or frame - See page 246.

PLUTON

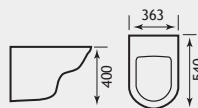

Description	Code	£ Ex VAT	£ Inc VAT
Pluton wall hung WC pan	83.0008	84.00	100.80
Pluton soft close seat	83.0007	84.00	100.80

FARRINGDON

Soft Close Seat 

Rimless Tech 

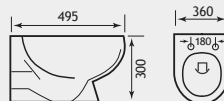

Description	Code	£ Ex VAT	£ Inc VAT
Farringdon Rimless Wall hung pan	26.0081	155.00	186.00
Northall / Farringdon Wrap Over Soft Close Seat	26.0056	50.00	60.00

NORTHALL

Soft Close Seat 

Rimless Tech 

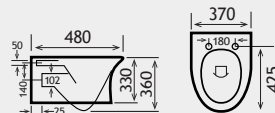

Description	Code	£ Ex VAT	£ Inc VAT
Northall Rimless Wall Hung Pan	26.0104	165.00	198.00

CONCEALED CISTERNS & FRAMES

Concealed Cistern & Frames	Code	£ Ex VAT	£ Inc VAT
Concealed Cistern & Frame 1109 x 555†	73.0001	192.00	230.40
Concealed Cistern & Frame 795 x 400†	73.0002	184.00	220.80

Pneumatic Concealed Cistern & Frames	Code	£ Ex VAT	£ Inc VAT
Pneumatic concealed cistern and frame 820x500x150 †	90.0001	162.00	194.40
Pneumatic concealed cistern and frame 1160x400x90 †	90.0002	162.00	194.40

FEATURES: 73. Code cisterns suitable from 0.2 bar

† For more information see pages 246-247.

ELECTRONIC ECO FLUSH

The new, hygienic, no touch flushing system with water saving Eco-Stop flushing technology, allows the user to control how much water is needed to clear the toilet.

BUILT IN SENSOR

This system flushes for as long as the sensor is covered which allows the user to flush the toilet for just the right length of time needed to clear.

15,000 FLUSHING CYCLES PER BATTERY

It is a battery operated system giving a typical 15,000 flushing cycles before battery replacement is needed. It also has a manual over-ride in the unlikely event of battery failure.

ECO FLUSH

Description	Code	£ Ex VAT	£ Inc VAT
Jollytronic universal bottom entry cistern fitting	7.0000	99.00	118.80

For ceramic cisterns only



Jollytronic

Water Saving Tech



Concealed Cisterns

Concealed cisterns pneumatic mechanism			
Description	Code	£ Ex VAT	£ Inc VAT
Concealed cistern and frame 820x500x150*	90.0001	162.00	194.40
Concealed cistern and frame 1160x500x90*	90.0002	162.00	194.40
Pneumatic universal concealed cistern	90.0003	93.00	111.60
Eastbrook pneumatic hidden cistern, top inlet**	90.0004	80.00	96.00

* A push plate is required, see below for options.

** 90.0004 Push button supplied in box.

Cisterns compatible with Oslo tall cistern units see pages 352-359, or built in only.

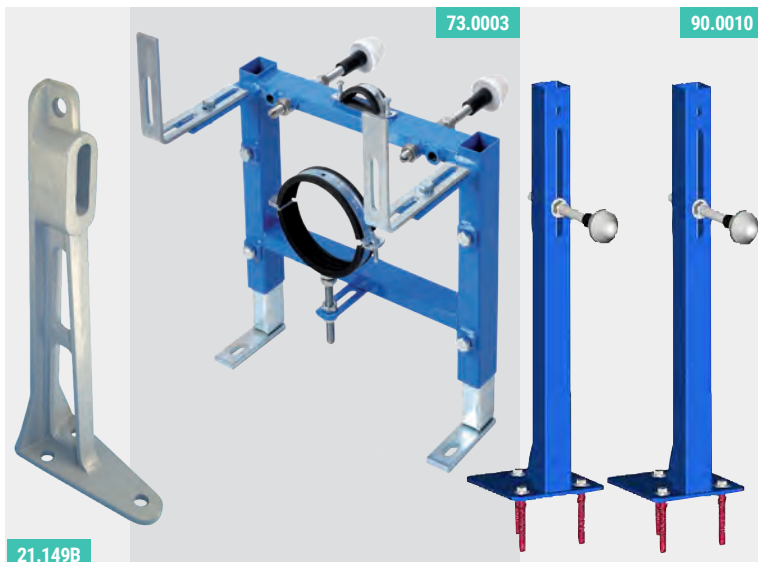
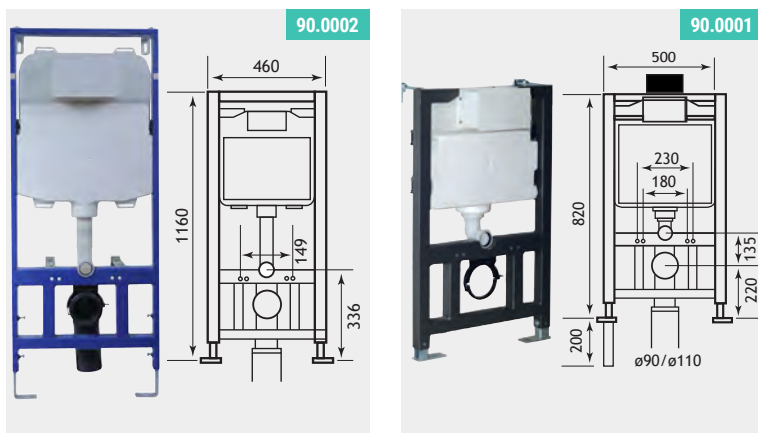
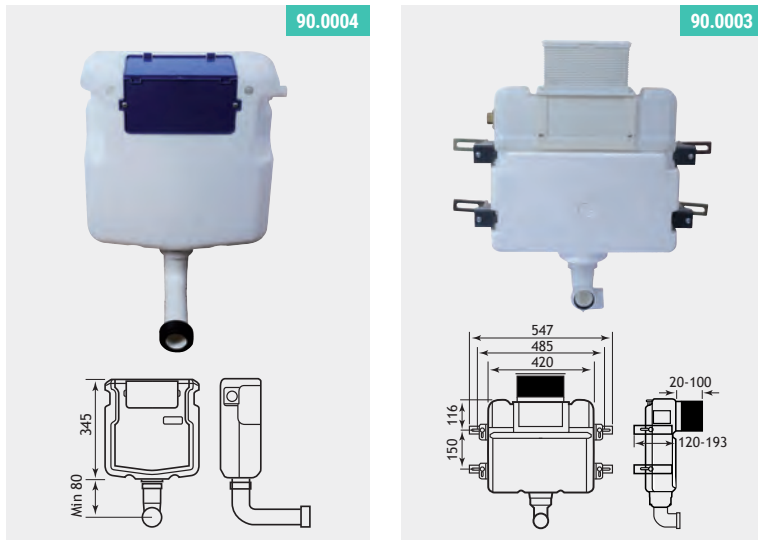

21.149B

CONCEALED CISTERNS

FEATURES

- WRAS approved flushing components
- Large fitting tolerance
- Solid fixing kits
- 90.0004 easy to maintain, front and top access
- Pneumatic controlled flush



Push plates			
Description	Code	£ Ex VAT	£ Inc VAT
Push plate square White	90.0005	12.00	14.40
Push plate square Chrome	90.0006	23.00	27.60
Push plate round Chrome	90.0007	23.00	27.60
Push plate round White	90.0008	12.00	14.40

The above push plates are only compatible with 90 code concealed cisterns.

Pneumatic Mechanism

Tried and Tested

As part of our product testing, greater functionality development and compliance certification, we test our products for a simulated lifetime of use. We were looking to measure the wear and tear on this cistern and fittings based on 10 flushes a day for 30 years which is 109,500 flushes. This product has sailed past this figure and now is over 360,000 flushes!!

Brackets			
Description	Code	£ Ex VAT	£ Inc VAT
Wall Hung Pan/Bidet Brackets	21.149B	140.00	168.00
Mirage Frame 310 x 345	73.0003	115.00	138.00
L-Shape Wall Hung Pan/Bidet Brackets	90.0010	56.00	67.20

Sanitaryware Accessories

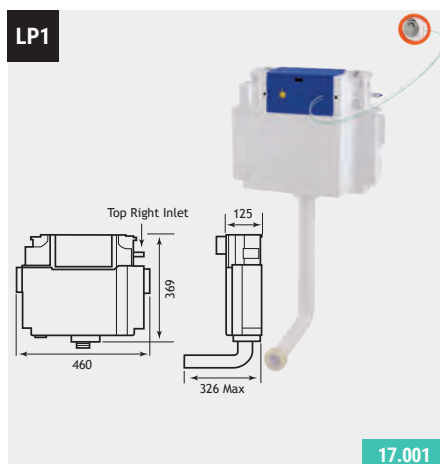
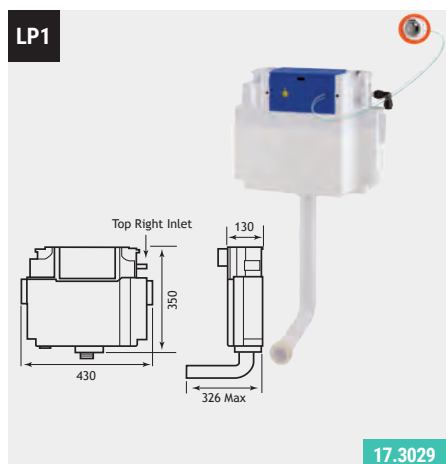

Hidden Cisterns

Description	Code	£ Ex VAT	£ Inc VAT
Vantage hidden cistern with jacket	17.3029	155.00	186.00
Vantage Plain Hidden Cistern CP Push Button	17.001	133.00	159.60
Eastbrook Jacket Hidden Cistern - Bottom Inlet	53.001	82.00	98.40

Cisterns compatible with standards height units, or built in.

FEATURES

- WRAS approved flushing components
- Delay fill inlet valve - no water waste
- 17.3029 & 17.001 have pneumatic controlled flush
- 53.001 has cable controls

Required minimum operating pressure key

LP1	- 0.1 bar minimum
LP2	- 0.2 bar minimum

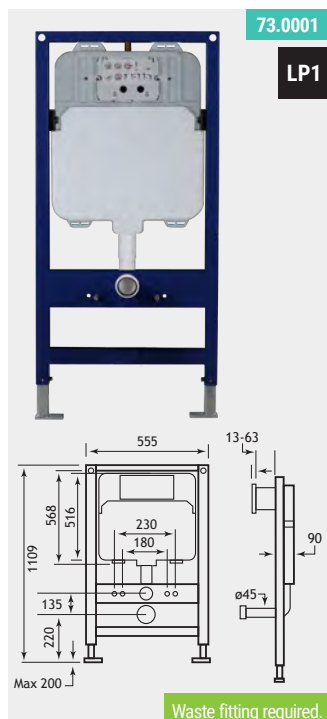
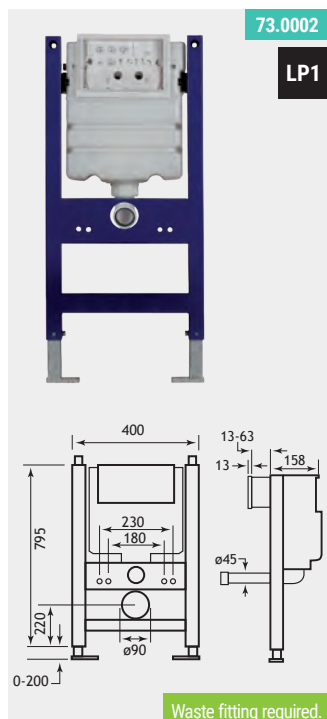

Concealed Cisterns

Description	Code	£ Ex VAT	£ Inc VAT
Concealed Cistern & Frame 1109 x 555 (Wall Hung)	73.0001	192.00	230.40
Concealed Cistern & Frame 795 x 400 (Wall Hung)	73.0002	184.00	220.80
Concealed Cistern 568 x 445 x 80 (BTW)*	73.0004	84.00	100.80
Concealed Cistern 350 x 290 x 150 (BTW)*	73.0005	78.00	93.60

Cisterns compatible with Oslo tall cistern units see pages 352-359, or built in only. *A flush plate is required, please see this page for options.

Flush Plates

Description	Code	£ Ex VAT	£ Inc VAT
R Series Flush Plate Chrome	73.0006	26.00	31.20
R Series Flush Plate Silver Grey	73.0007	23.00	27.60
R Series Flush Plate Chrome/ Black Ring	73.0008	25.00	30.00
V Series Flush Plate Chrome	73.0009	26.00	31.20
V Series Flush Plate Silver Grey	73.0010	23.00	27.60
V Series Flush Plate Black/Chrome Button	73.0011	23.00	27.60
W Series Flush Plate Chrome	73.0013	26.00	31.20
W Series Flush Plate Chrome/Colour Buttons	73.0014	25.00	30.00

The above flush plates are only compatible with 73 code concealed cisterns.

FEATURES

- 73. Code cisterns suitable from 0.2 bar
- Rud controlled flush

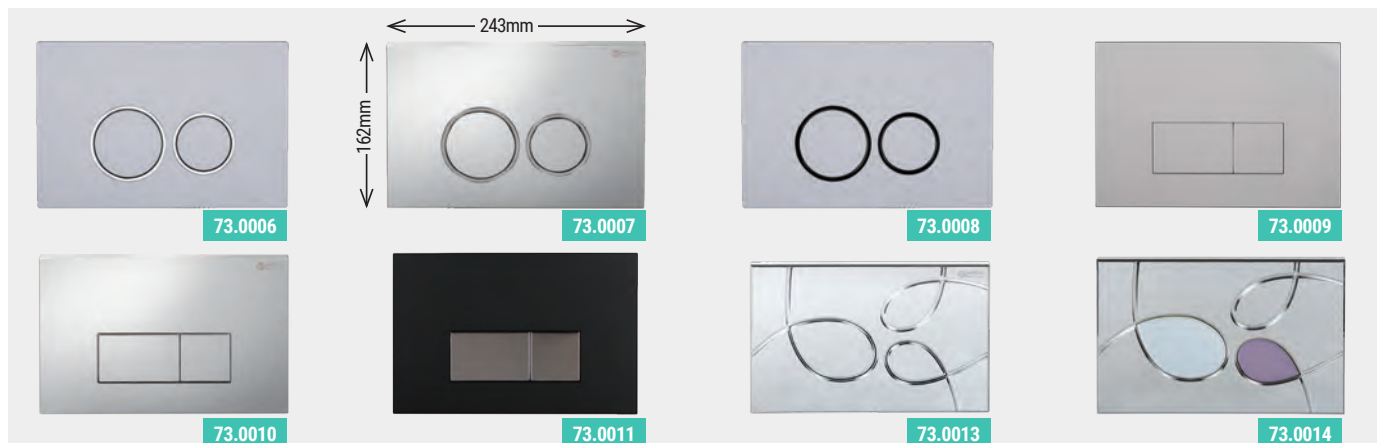



reddot design award

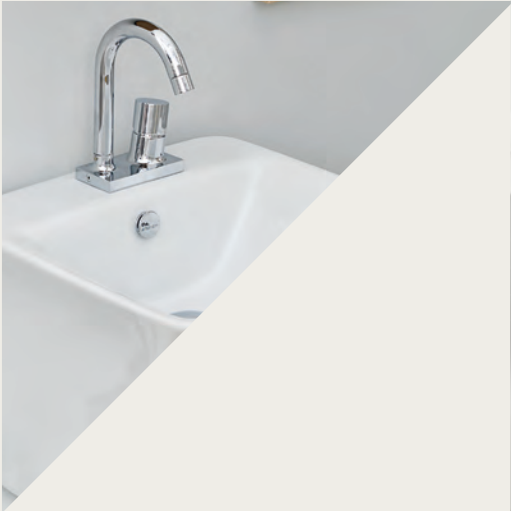

NORTHBROOK

THE ITALIAN COLLECTION

The Italian Ceramics Industry is recognised throughout the world as a synonym for quality and design flair. We are now working to supply leading edge designs for our customers, which cannot be replicated by volume producers.

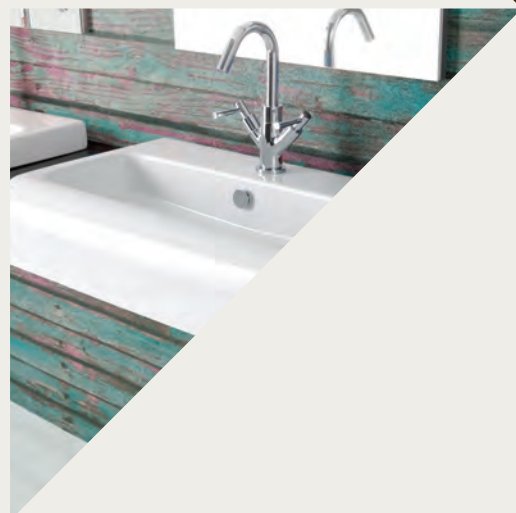
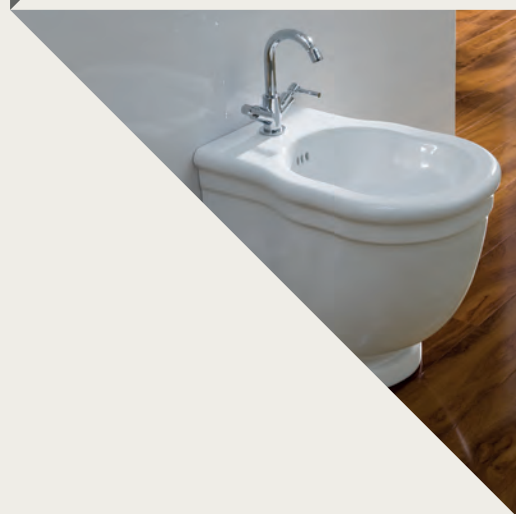
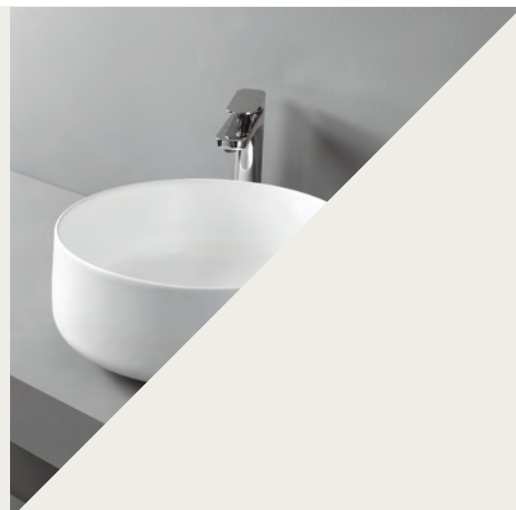

Contents

Albano	252 - 255
Alento	256 - 259
Conca	260 - 261
Enza	262 - 265
Fino	266 - 273
Mezzano	274 - 275
Novara	276 - 279
Perlita	280 - 285
Piave	286 - 291
Tavo	292 - 293
Topino	294 - 295
Alento Ceramic Shelf	296
Accessories	297

NORTHBROOK

10 YEAR WARRANTY

EVERY ITEM HAND FINISHED

MADE IN ITALY

EXCLUSIVE TO SHOWROOMS

BIDETS TO MATCH EVERY RANGE

KEPT IN UK STOCKS

NICHE DESIGNS

REFINED AND GRACEFUL OR BOLD
AND PLAYFUL, NORTHBROOK'S
ITALIAN RANGE OFFERS A
CONTEMPORARY TWIST ON CLASSIC
BATHROOM STYLING THAT DELIGHTS
THE SENSES AND SOOTHES THE SOUL



Northbrook - An Introduction

Renowned for its ceramics since the Middle Ages and famous for its effortless glamour, some of the world's most sought-after sanitaryware is designed and manufactured in Italy.

Northbrook's range of fine Italian sanitaryware is hand selected for its distinctive beauty and attention to detail. Produced by craftsmen with generations of expertise, each piece is elegantly and impeccably finished by hand for quality and flair that will stand the test of time.

Our timeless sanitaryware lends poise and a dash of indulgent style to the most functional spaces in the modern home.

Always with a nod to classic Italian design, there's something to suit every interior and every personality.

With captivating lines and pared back styling, the graceful simplicity of Northbrook's Italian range creates a sanctuary to ease body and soul.



Albano

The Albano collection offers timeless simplicity. It has been meticulously designed to create a minimalistic sanctuary.



Warranty
10
Year



Albano Basin with Pedestal			
Description	Code	£ Ex VAT	£ Inc VAT
Albano Basin 650mm	95.075	137.00	164.40
Pedestal	95.076	71.00	85.20



Albano Basin with Semi Pedestal			
Description	Code	£ Ex VAT	£ Inc VAT
Albano 650mm Basin	95.075	137.00	164.40
Fischer Bolts Set - Basin to Wall	9.201	11.00	13.20
Albano Semi-Pedestal	95.077	74.00	88.80

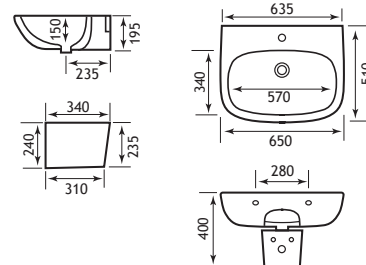
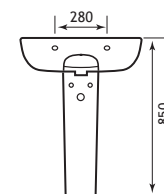
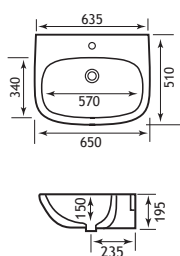

Albano



Warranty
10
Year

Albano Basin			
Size	Code	£ Ex VAT	£ Inc VAT
Albano Basin 650mm	95.075	137.00	164.40
Fischer Bolts Set - Basin to Wall	9.201	11.00	13.20
Luxury Bottle Trap	95.120	95.00	114.00

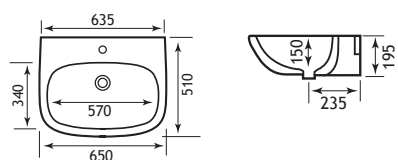



Albano BTW WC Pan

Description	Code	£ Ex VAT	£ Inc VAT
Albano BTW WC Pan	95.067	174.00	208.80
Albano Soft Close Seat	95.074	103.00	123.60

For concealed cisterns see pages 226-227

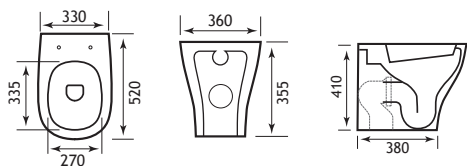

Albano Wall Hung WC Pan

Description	Code	£ Ex VAT	£ Inc VAT
Albano Wall Hung BTW WC Pan	95.064	193.00	231.60
Albano Soft Close Seat	95.074	103.00	123.60

For concealed cisterns see pages 226-227

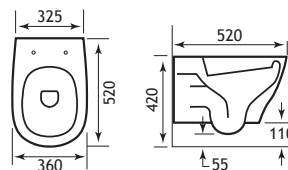

Albano BTW Bidet

Description	Code	£ Ex VAT	£ Inc VAT
Albano BTW Bidet	95.068	173.00	207.60
Fischer Bolt Set	9.204	16.00	19.20

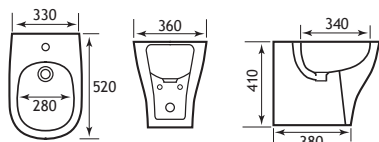

Albano Wall Hung Bidet

Description	Code	£ Ex VAT	£ Inc VAT
Albano Wall Hung Bidet	95.065	171.00	205.20
Exposed Reduced Height Trap	95.129	84.00	100.80
Fitting System for Wall Hung Items	95.128	48.00	57.60

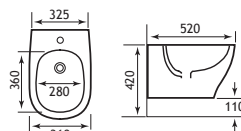

Alento

The Alento range exemplifies simplicity and functionality. Its simple design blends with any bathroom style.



Warranty
10
Year



Alento Close Coupled WC Pan

Description	Code	£ Ex VAT	£ Inc VAT
Alento Close Coupled WC Pan	95.032†	357.00	428.40
Alento Ceramic Cistern only	95.033†	133.00	159.60
Geberit Cistern Fittings For 95.033**	95.126	84.00	100.80
Alento Soft Close Seat	95.035†	137.00	164.40

**Cistern Fittings are required to go with 95.033.

†While stocks last

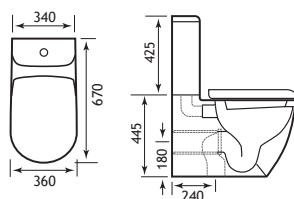

Alento BTW Bidet

Description	Code	£ Ex VAT	£ Inc VAT
Alento BTW Bidet	95.031†	231.00	277.20
Fischer Bolt Set	9.204	16.00	19.21

†While stocks last

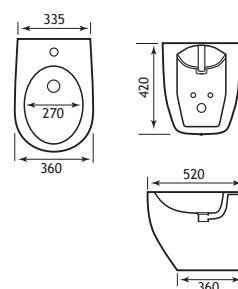

Alento



Alento BTW WC Pan

Description	Code	£ Ex VAT	£ Inc VAT
Alento BTW WC Pan	95.030†	231.00	277.20
Alento Soft Close Seat	95.035†	137.00	164.40

For concealed cisterns see pages 226-227.

†While stocks last

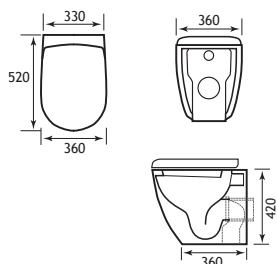

Alento Wall Hung WC Pan

Description	Code	£ Ex VAT	£ Inc VAT
Alento Wall Hung WC Pan	95.028†	246.00	295.20
Alento Soft Close Seat	95.035†	137.00	164.40

For wall-hung frames and concealed cisterns see pages 226-227.

†While stocks last

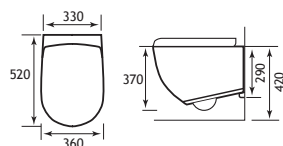

Alento Wall Hung Bidet

Description	Code	£ Ex VAT	£ Inc VAT
Alento Wall Hung Bidet	95.029†	231.00	277.20
Exposed Reduced Height Trap	95.129	84.00	100.80
Fitting System For Wall Hung Items	95.128	48.00	57.60

†While stocks last

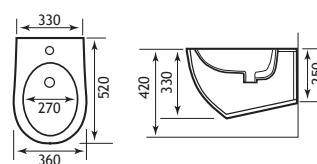



Warranty
10
Year



Alento Curved 600mm Wall Hung Basin

Description	Code	£ Ex VAT	£ Inc VAT
Alento Curved 600mm Wall Hung Basin	95.036†	345.00	414.00

For wall fixings see pages 269.

†While stocks last

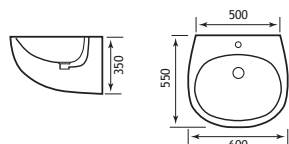

Alento 600mm Wall Hung Basin

Description	Code	£ Ex VAT	£ Inc VAT
Alento 600mm Wall Hung Basin	95.037†	189.00	226.80

For wall fixings see pages 269.

†While stocks last

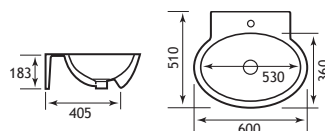

Conca

Made from 'livingtec', a compact, non porous material based on alumina and a small percentage of resins of polyester acrylic, Livingtec is pleasant to the touch and has a very bright and uniform finish due to the high gloss spray treatment applied.

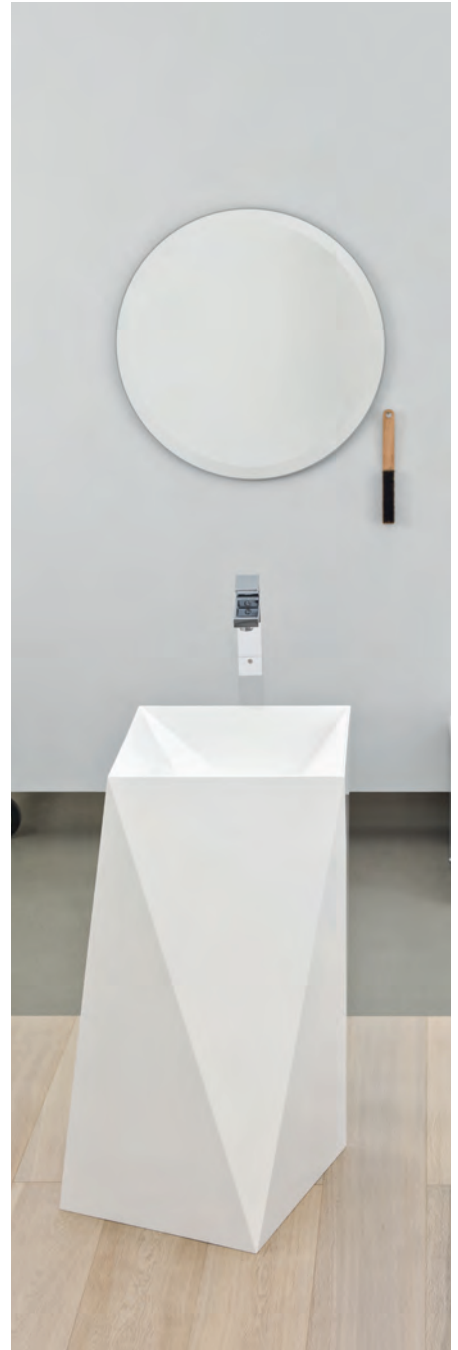

Warranty
10
Year



reddot design award

The International Red Dot Jury only bestows this quality seal on products which set themselves apart with their good design from comparable objects on the market.

Conca Freestanding Basin

Description	Code	£ Ex VAT	£ Inc VAT
Conca Freestanding Basin	95.116†	2625.00	3150.00

Supplied with free waste. †While stocks last



Conca 420mm Sit On Basin			
Description	Code	£ Ex VAT	£ Inc VAT
Conca 420mm Sit On Basin	95.118†	242.00	290.40

†While stocks last.

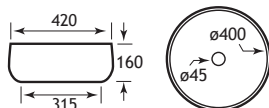

Conca 480mm Sit On Basin			
Description	Code	£ Ex VAT	£ Inc VAT
Conca 480mm Sit On Basin	95.117†	263.00	315.60

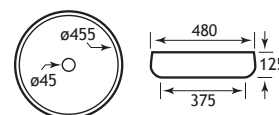

Conca Wall hung/Sit On basin			
Description	Code	£ Ex VAT	£ Inc VAT
Conca Wall hung/Sit On basin	95.133†	420.00	504.00

For wall fixing see page 269.

†While stocks last

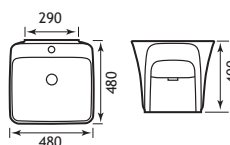

Conca Wide Wall Hung Basin			
Description	Code	£ Ex VAT	£ Inc VAT
Conca Wide Wall Hung Basin	95.130†	1890.00	2268.00

Supplied with free waste. For wall fixings see page 269.

†While stocks last

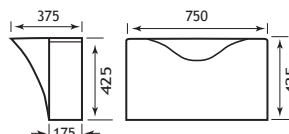

Conca Wide Freestanding Basin			
Description	Code	£ Ex VAT	£ Inc VAT
Conca Wide Freestanding Basin	95.131†	2100.00	2520.00

Supplied with free waste. For wall fixings see page 269.

†While stocks last

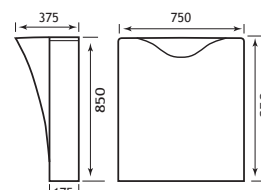

Enza

The clean lines of the Enza range are the epitome of elegant minimalism. Choose items from the Enza range for a beautifully co-ordinated finish.



Warranty
10
Year



Enza BTW WC Pan			
Description	Code	£ Ex VAT	£ Inc VAT
Enza BTW WC Pan	95.106	357.00	428.40
Enza Soft Close Seat With Chrome Plated Hinge	95.107	158.00	189.60



Enza BTW Bidet			
Description	Code	£ Ex VAT	£ Inc VAT
Enza BTW Bidet	95.108	357.00	428.40
Fischer Bolt Set	9.204	16.00	19.21

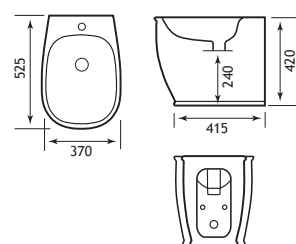
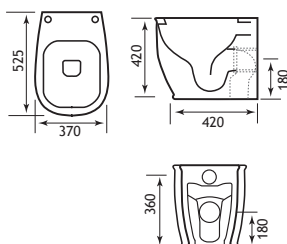



Enza Wall Hung WC Pan

Description	Code	£ Ex VAT	£ Inc VAT
Enza Wall Hung WC Pan	95.102	357.00	428.40
Enza Soft Close Seat With Chrome Plated Hinge	95.107	158.00	189.60

For wall-hung frames and concealed cisterns see pages 226-227.

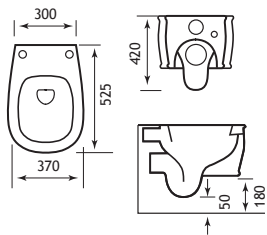

Enza Wall Hung Bidet

Description	Code	£ Ex VAT	£ Inc VAT
Enza Wall Hung Bidet	95.103	357.00	428.40
Exposed Reduced Height Trap	95.129	84.00	100.80
Fitting System For Wall Hung Items	95.128	48.00	57.60

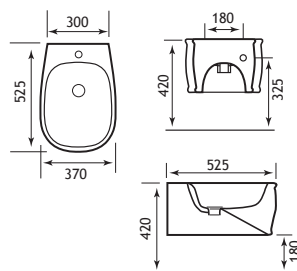

95.109



95.110

Enza 450mm Sit On Basin

Description	Code	£ Ex VAT	£ Inc VAT
Enza 450mm Sit On Basin	95.109	252.00	302.40
Enza 650mm Sit On Basin	95.110	273.00	327.60
Luxury bottle trap	95.120	95.00	114.00

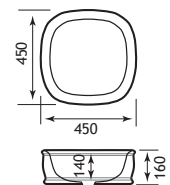

95.109

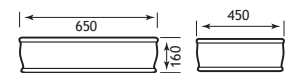

95.110

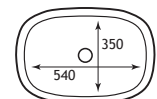



95.111



95.113

Enza 720mm Wall Hung/Sit On Basin			
Description	Code	£ Ex VAT	£ Inc VAT
Enza 720mm Wall Hung/Sit On Basin	95.111	294.00	352.80
Enza 910mm Wall Hung/Sit On Basin	95.113	315.00	378.00
Luxury bottle trap	95.120	95.00	114.00

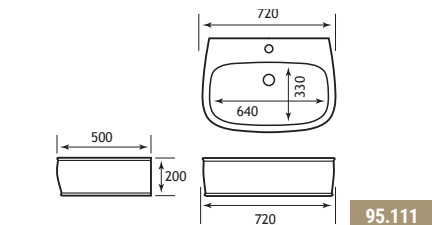

95.111

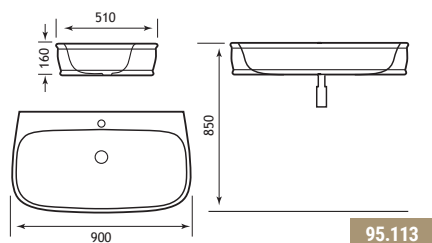

95.113



Enza 720mm Wall Hung/Sit On Basin			
Description	Code	£ Ex VAT	£ Inc VAT
Enza 720mm Wall Hung/Sit On Basin	95.111	294.00	352.80
Enza Framework For 720mm Wash Basin	95.114	630.00	756.00
Luxury bottle trap	95.120	95.00	114.00
Fischer Bolt Set	9.204	16.00	19.21

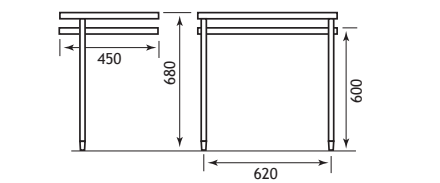

95.115



95.134

Enza Framework White (above) / Black (below)			
Description	Code	£ Ex VAT	£ Inc VAT
Enza Framework with white top	95.115	1155.00	1386.00
Enza Framework with black top	95.134	1155.00	1386.00

Top supplied uncut to accommodate any basin or tap.

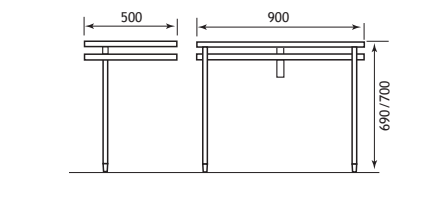

Fino

The Fino range is a timeless collection which brings the best of traditional and contemporary design together. It is a versatile collection which suits a classical bathroom or can be accessorised with taps to suit a more contemporary style.



Warranty
10
Year

Fino Wall Hung Bidet

Description	Code	£ Ex VAT	£ Inc VAT
Fino Wall Hung Bidet	95.039	284.00	340.80
Exposed Reduced Height Trap	95.129	84.00	100.80
Fitting System For Wall Hung Bidet	95.128	48.00	57.60

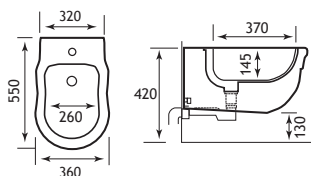

Fino Wall Hung WC Pan

Description	Code	£ Ex VAT	£ Inc VAT
Fino Wall Hung WC Pan	95.038	284.00	340.80
Fino Soft Close Seat	95.053	158.00	189.60

For wall-hung frames and concealed cisterns see pages 226-227.

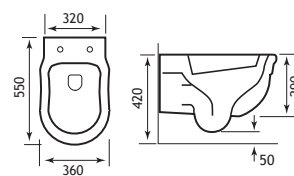



Fino BTW WC Pan

Description	Code	£ Ex VAT	£ Inc VAT
Fino BTW WC Pan	95.040	315.00	378.00
Fino Soft Close Seat	95.053	158.00	189.60
Fischer Bolt Set	9.204	16.00	19.21



Fino BTW Bidet

Description	Code	£ Ex VAT	£ Inc VAT
Fino BTW Bidet	95.041	315.00	378.00

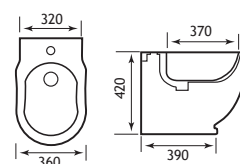
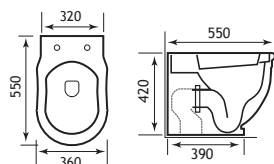

Fino



Fino Close Coupled BTW Pan

Description	Code	£ Ex VAT	£ Inc VAT
Fino Close Coupled BTW Pan	95.045	410.00	492.00
Fino Ceramic Cistern to Match 95.045	95.046	168.00	201.60
Geberit Cistern Fittings to match 95.046	95.121	179.00	214.80
Fino Soft Close Seat	95.053	158.00	189.60

Cistern fittings are required to go with 95.046.

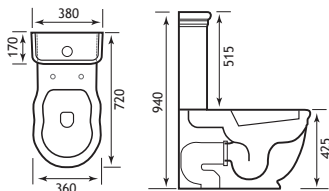

Fino Close Coupled WC Pan

Description	Code	£ Ex VAT	£ Inc VAT
Fino Close Coupled WC Pan	95.042	336.00	403.20
Fino Ceramic Cistern to Match 95.045	95.043	168.00	201.60
Fino Cistern Fittings to Match 95.043	95.123	84.00	100.80
Fino Soft Close Seat	95.053	158.00	189.60

Cistern fittings are required to go with 95.043.

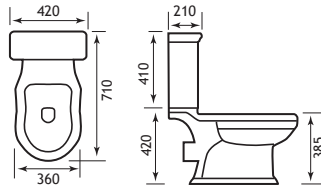

Fino WC Pan

Description	Code	£ Ex VAT	£ Inc VAT
Fino WC Pan	95.048	305.00	366.00
Fino Low Level Ceramic Cistern	95.051	168.00	201.60
Low Level Cistern Fittings to Match 95.051	95.052	399.00	478.80
Fino Soft Close Seat	95.053	158.00	189.60

Cistern fittings are required to go with 95.051.

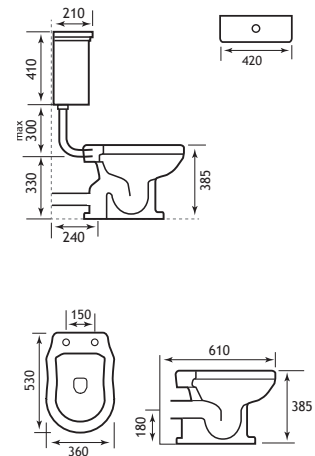



Fino WC Pan

Description	Code	£ Ex VAT	£ Inc VAT
Fino WC Pan	95.048	305.00	366.00
Fino High Ceramic Cistern	95.049	168.00	201.60
High Level Cistern Fittings with Chain and Ceramic Pull Handle to Match 95.049	95.050	399.00	478.80
Fino Soft Close Seat	95.053	158.00	189.60

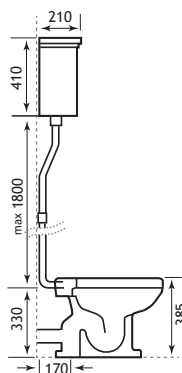

High level cistern



Warranty
10
Year

Fino



Warranty
10
Year



Fino 680mm Basin			
Description	Code	£ Ex VAT	£ Inc VAT
Fino 680mm Basin	95.054	389.00	466.80
Fino Framework For 680mm Basin	95.061	998.00	1197.60
Luxury Bottle Trap	95.120	95.00	114.00

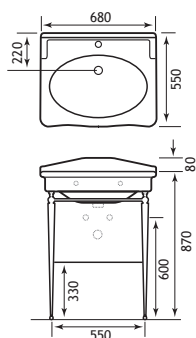

Fino Console Basin 920mm			
Description	Code	£ Ex VAT	£ Inc VAT
Fino Console Basin 920mm	95.056	620.00	744.00
Fino Framework For 920mm Basin	95.062	1260.00	1512.00
Luxury Bottle Trap	95.120	95.00	114.00

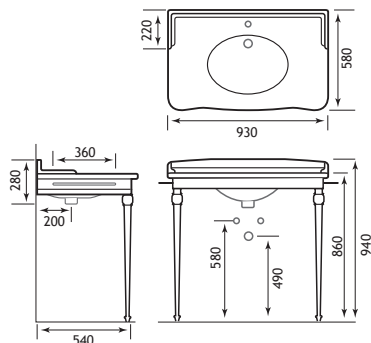

Fino 1120mm Console Basin			
Description	Code	£ Ex VAT	£ Inc VAT
Fino 1120mm Console Basin	95.057	641.00	769.20
Fino Framework For 1120mm Basin	95.063	1208.00	1449.60
Luxury Bottle Trap	95.120	95.00	114.00

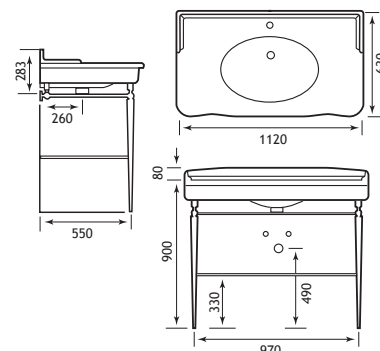

Fino



Warranty
10
Year

Fino



Fino 680mm Basin

Description	Code	£ Ex VAT	£ Inc VAT
Fino 680mm Basin	95.054	389.00	466.80
Fino Pedestal	95.055	179.00	214.80

Can be fitted with 2 or 4 legs but only 2 supplied.

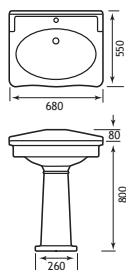

Fino Console Basin 920mm

Description	Code	£ Ex VAT	£ Inc VAT
Fino Console Basin 920mm	95.056	620.00	744.00
Fino Pair Of Slim Ceramic Legs	95.059	347.00	416.40
Luxury Bottle Trap	95.120	95.00	114.00

Can be fitted with 2 legs (2 supplied 95.059).

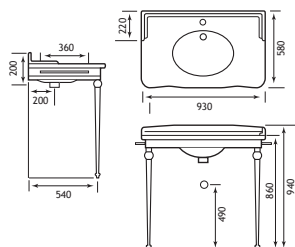

Fino 1120mm Console Basin

Description	Code	£ Ex VAT	£ Inc VAT
Fino 1120mm Console Basin	95.057	641.00	769.20
Fino pair of Coppia ceramic legs	95.058	347.00	416.40
Luxury Bottle Trap	95.120	95.00	114.00

Can be fitted with 2 or 4 legs but only 2 supplied.

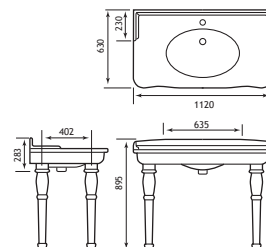

Leg options: Legs will fit with 920 or 1120mm Fino basins.



Fino Pair Of Tonda Ceramic Legs

Description	Code	£ Ex VAT	£ Inc VAT
-------------	------	----------	-----------



Fino Pair Of Coppia Ceramic Legs

Description	Code	£ Ex VAT	£ Inc VAT
-------------	------	----------	-----------



Fino Pair Of Slim Ceramic Legs

Description	Code	£ Ex VAT	£ Inc VAT
-------------	------	----------	-----------

Mezzano

The unusual design of the Mezzano basins is sure to be a topic of conversation for all visitors!



Warranty
10
Year

All taps featured on these pages are for illustration purposes only.

Mezzano



Mezzano 450mm Wall Hung Basin			
Description	Code	£ Ex VAT	£ Inc VAT
Mezzano 450mm Wall Hung Basin	95.090	347.00	416.40
Mezzano Bottle Trap for 95.090	95.127	95.00	114.00

NB. Basin can only be fitted with bottle trap shown below.

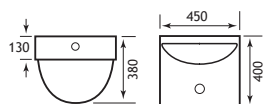

Mezzano 750mm Wall Hung Basin			
Description	Code	£ Ex VAT	£ Inc VAT
Mezzano 750mm Wall Hung Basin	95.089	410.00	492.00
Mezzano Bottle Trap for 95.089	95.127	95.00	114.00

NB. Basin can only be fitted with bottle trap shown below.

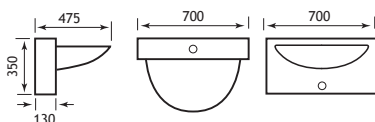

Mezzano 750mm Glass Wall Hung Basin			
Description	Code	£ Ex VAT	£ Inc VAT
Mezzano 750mm Glass Wall Hung Basin	95.091	651.00	781.20
Mezzano Bottle Trap for 95.091	95.127	95.00	114.00

NB. Basin can only be fitted with bottle trap shown below.

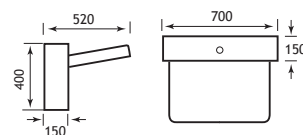

Novara

The Novara range features a short projection pan and bidet, known as 'Novara Mini'. Measuring only 490mm deep they are an ideal solution for smaller rooms.



Warranty
10
Year



Novara Mini Wall Hung Bidet

Description	Code	£ Ex VAT	£ Inc VAT
Novara Mini Wall Hung Bidet	85.0002†	368.00	441.60

†While stocks last.

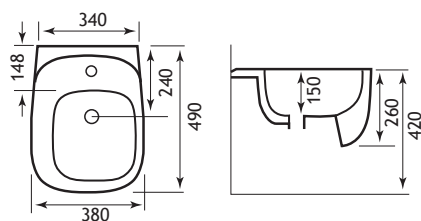

Novara



Warranty
10
Year

All taps featured on these pages are for illustration purposes only.

Novara Close Coupled WC Pan			
Description	Code	£ Ex VAT	£ Inc VAT
Novara Close Coupled WC Pan	85.0005†	490.00	588.00
Geberit Cistern Fittings to Match 85.0006	85.0007†	179.00	214.80
Novara Ceramic Cistern	85.0006†	206.00	247.20
Novara Soft Closing Seat	85.0008†	160.00	192.00

Cistern fittings are required to go with 85.0006.

†While stocks last.

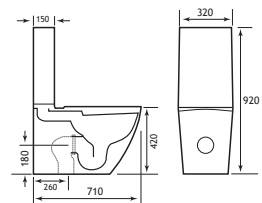



Novara Washbasin

Description	Code	£ Ex VAT	£ Inc VAT
Novara Washbasin	85.0011†	252.00	302.40
Novara Pedestal	85.0012†	147.00	176.40

†While stocks last

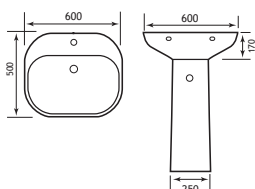

Novara Deeper Washbasin

Description	Code	£ Ex VAT	£ Inc VAT
Novara Deeper Washbasin	85.0013†	252.00	302.40
Novara Pedestal	85.0012†	147.00	176.40

†While stocks last

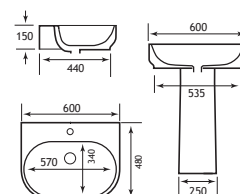

Perlita

The Perlita Range is design led yet functional. In 2009 the Perlita Wall Hung WC won the Red Dot Design Award. Perlita's beautiful round shape makes it an unusual addition to any bathroom.



Warranty
10
Year

Perlita



Perlita BTW WC Pan

Description	Code	£ Ex VAT	£ Inc VAT
Perlita BTW WC Pan	95.002	315.00	378.00
Perlita Soft Close Seat	95.005	158.00	189.60

For concealed cisterns see pages 246-247.



Perlita BTW Bidet

Description	Code	£ Ex VAT	£ Inc VAT
Perlita BTW Bidet	95.003†	315.00	378.00
Fischer Bolt Set	9.204	16.00	19.21

For concealed cisterns see pages 246-247.

†While stocks last



reddot design award

The International Red Dot Jury only bestows this quality seal on products which set themselves apart with their good design from comparable objects on the market.

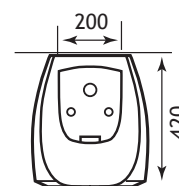
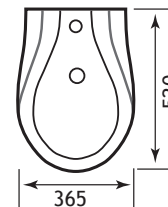
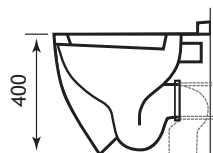
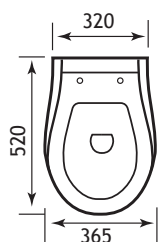

Perlita



Warranty
10
Year



Perlita 460mm Sit On Basin			
Description	Code	£ Ex VAT	£ Inc VAT
Perlita 460mm Sit On Basin	95.007	263.00	315.60
Luxury Bottle Trap	95.120	95.00	114.00

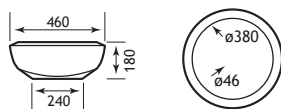

Perlita Wall Hung WC Pan			
Description	Code	£ Ex VAT	£ Inc VAT
Perlita Wall Hung WC Pan	95.000	315.00	378.00
Perlita Soft Close Seat	95.005	158.00	189.60

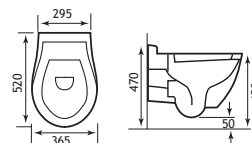

For wall-hung frames and concealed cisterns see pages 246-247.



Perlita Wall Hung Bidet			
Description	Code	£ Ex VAT	£ Inc VAT
Perlita Wall Hung Bidet	95.001†	315.00	378.00
Exposed Reduced Height Trap	95.129	84.00	100.80
Fitting System For Wall Hung Items	95.128	48.00	57.60

†While stocks last

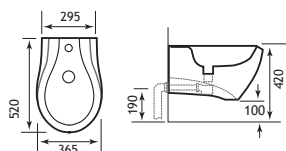

Perlita Close Coupled WC Pan			
Description	Code	£ Ex VAT	£ Inc VAT
Perlita Close Coupled WC Pan	95.004	420.00	504.00
Perlita Ceramic Cistern	95.006	179.00	214.80
Geberit Cistern Fittings to match 95.006 *	95.121	179.00	214.80
Perlita Soft Close Seat	95.005	158.00	189.60

*Cistern fittings are required to go with 95.006.

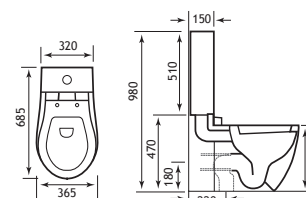



Warranty
10
Year

Perlita 550mm Wall Hung Basin			
Description	Code	£ Ex VAT	£ Inc VAT
Perlita 550mm Wall Hung Basin	95.008	294.00	352.80
Luxury Bottle Trap	95.120	95.00	114.00
Fischer Bolts Set	9.204	16.00	19.21

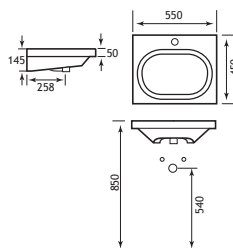

Perlita 710mm Wall Hung Basin			
Description	Code	£ Ex VAT	£ Inc VAT
Perlita 710mm Wall Hung Basin	95.010	326.00	391.20
Towel Holder For 710mm Perlita Wall Hung Basin	95.011†	95.00	114.00
Luxury Bottle Trap	95.120	95.00	114.00

†While stocks last

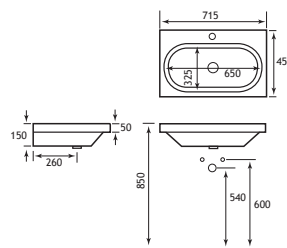



Warranty
10
Year

Perlita 910mm Wall Hung Basin			
Description	Code	£ Ex VAT	£ Inc VAT
Perlita 910mm Wall Hung Basin	95.012	336.00	403.20
Towel Holder For 910mm Perlita Wall Hung Basin	95.013†	105.00	126.00
Luxury Bottle Trap	95.120	95.00	114.00
Fischer Bolts Set	9.204	16.00	19.20

†While stocks last

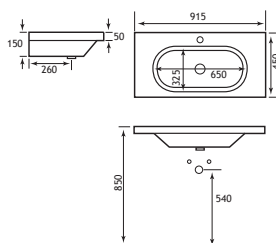

Perlita 1060mm Wall Hung Basin			
Description	Code	£ Ex VAT	£ Inc VAT
Perlita 1060mm Wall Hung Basin	95.014	357.00	428.40
Towel Holder For 1060mm Perlita Wall Hung Basin	95.015†	116.00	139.20
Luxury Bottle Trap	95.120	95.00	114.00

†While stocks last

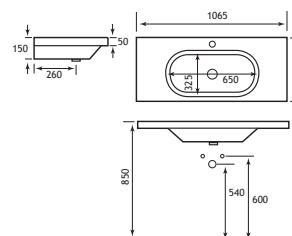

Piave

The Piave Range is Innovative. Every item in this range has a 20mm recess that allows the insertion of any material of your choice, giving the option to create a personalised suite. Insert Hydropanel, tiling, wood, a mosaic... Imagination is the only limit.



Warranty
10
Year



We have inserted black Hydro-panelling in to the recess for our images, the goods will come supplied in plain white.



Piave Close Coupled Pan			
Description	Code	£ Ex VAT	£ Inc VAT
Piave Close Coupled WC Pan	95.020†	515.00	618.00
Piave Ceramic Cistern	95.021†	174.00	208.80
Geberit Cistern Fittings to match 95.021	95.121†	179.00	214.80
Piave Soft Close Seat	95.022†	161.00	193.20

Cistern fittings are required to go with 95.021.
While stocks last †

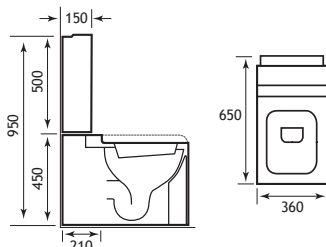

Piave BTW WC Pan			
Description	Code	£ Ex VAT	£ Inc VAT
Piave BTW WC Pan	95.018†	410.00	492.00
Piave Soft Close Seat	95.022†	161.00	193.20
Fischer Bolts Set	9.204†	16.00	19.20

For concealed cisterns see pages 246-247.
While stocks last †

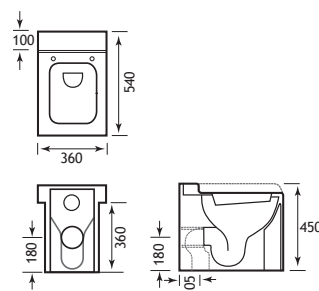

Piave



The Piave Range has a recess of approximately 20mm, allowing the insertion of any material of your choice. The goods will come supplied in plain white. In the above images we have given some suggestions to the alternative finishes you could create. Use Hydropanel, wood, glass, tile. See below to see how easy it is to fit our Hydropanel into the recess.





Piave 550mm Wall Hung Basin			
Description	Code	£ Ex VAT	£ Inc VAT
Piave 550mm Wall Hung Basin	95.025†	368.00	441.60
Exposed Reduced Height Trap	95.129	84.00	100.80

†While stocks last

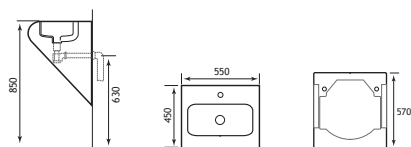

Piave BTW Bidet			
Description	Code	£ Ex VAT	£ Inc VAT
Piave BTW Bidet	95.019†	410.00	492.00
Fischer Bolts Set	9.204	16.00	19.20

†While stocks last

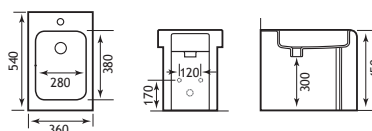

Piave Wall Hung Bidet			
Description	Code	£ Ex VAT	£ Inc VAT
Piave Wall Hung Bidet	95.017†	410.00	492.00
Exposed Reduced Height Trap	95.129	84.00	100.80
Fitting System For Wall Hung Items	95.128	48.00	57.60

†While stocks last

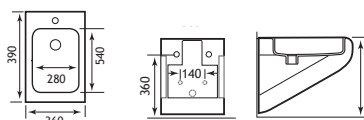

Piave



Warranty
10
Year

Piave



Piave Semi Recessed Basin			
Description	Code	£ Ex VAT	£ Inc VAT
Piave 650mm Semi-Recessed Basin	95.027†	242.00	290.40
Luxury Bottle Trap	95.120	95.00	114.00

†While stocks last

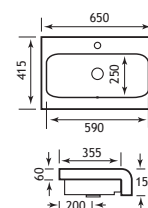

Piave 550mm Sit On Basin			
Description	Code	£ Ex VAT	£ Inc VAT
Piave 550mm Sit On Basin	95.023†	252.00	302.40
Luxury Bottle Trap	95.120	95.00	114.00

†While stocks last

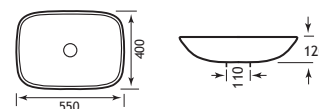

Piave 600mm Sit On Basin			
Description	Code	£ Ex VAT	£ Inc VAT
Piave 600mm Sit On Basin	95.024†	252.00	302.40
Luxury Bottle Trap	95.120	95.00	114.00

†While stocks last

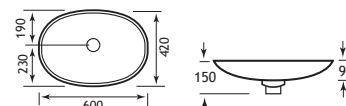

Tavo

The Tavo range will make a strong aesthetic statement in any bathroom



Tavo 650mm Wall Hung/Sit On Basin

Description	Code	£ Ex VAT	£ Inc VAT
Tavo 650mm Wall Hung/Sit On Basin	95.085	273.00	327.60
Fischer Bolts Set	9.204	16.00	19.21

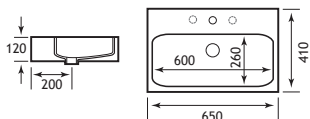

Tavo 900mm Wall Hung/Sit On Basin

Description	Code	£ Ex VAT	£ Inc VAT
Tavo 900mm Wall Hung/Sit On Basin	95.087†	368.00	441.60
Luxury Bottle Trap	95.120	95.00	114.00

†While stocks last

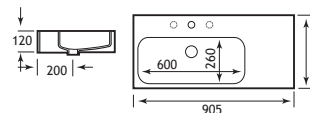



Tavo BTW WC Pan

Description	Code	£ Ex VAT	£ Inc VAT
Tavo BTW WC Pan	95.082†	347.00	416.40
Tavo Soft Close Seat	95.083†	158.00	189.60

For concealed cisterns see pages 226-227.

†While stocks last

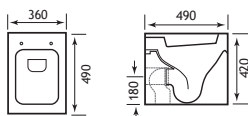

Tavo BTW Bidet

Description	Code	£ Ex VAT	£ Inc VAT
Tavo BTW Bidet	95.084†	347.00	416.40
Fischer Bolts Set	9.204	16.00	19.21

†While stocks last

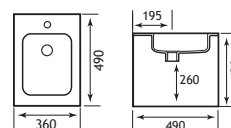

Tavo Wall Hung WC Pan

Description	Code	£ Ex VAT	£ Inc VAT
Tavo Wall Hung WC Pan	95.078†	347.00	416.40
Tavo Soft Close Seat	95.083†	158.00	189.60

For wall-hung frames and concealed cisterns see pages 246-247.

†While stocks last

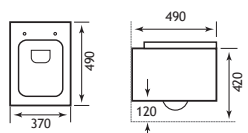

Tavo Wall Hung Bidet

Description	Code	£ Ex VAT	£ Inc VAT
Tavo Wall Hung Bidet	95.079†	347.00	416.40
Fitting System For Wall Hung Items	95.128	48.00	57.60

†While stocks last

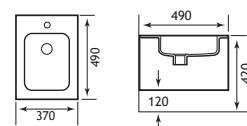

Topino

The beautifully crafted Topino range is the definitive luxury bathroom arrangement.



Warranty
10
Year

All taps featured on these pages are for illustration purposes only.

Topino Wall Hung WC Pan			
Description	Code	£ Ex VAT	£ Inc VAT
Topino Wall Hung WC Pan	95.093	368.00	441.60
Topino Soft Close Seat	95.098†	158.00	189.60

†While stocks last.

For wall-hung frames and concealed cisterns see pages 246-247.

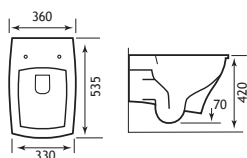

Topino Wall Hung Bidet			
Description	Code	£ Ex VAT	£ Inc VAT
Topino Wall Hung Bidet	95.094	368.00	441.60
Exposed Reduced Height Trap	95.129	84.00	100.80
Fitting System For Wall Hung Bidet	95.128†	48.00	57.60

†While stocks last.

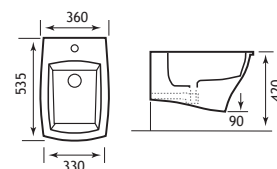

Topino



Topino BTW WC Pan

Description	Code	£ Ex VAT	£ Inc VAT
Topino BTW WC Pan	95.097	368.00	441.60
Topino Soft Close Seat With Chrome Plated Hinge	95.098†	158.00	189.60

†While stocks last.

For concealed cisterns see pages 246-247.

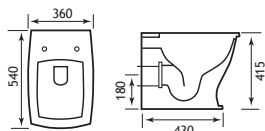

Topino BTW Bidet

Description	Code	£ Ex VAT	£ Inc VAT
Topino BTW Bidet	95.099†	368.00	441.60

†While stocks last.

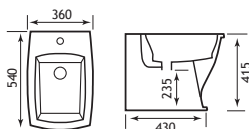

Topino Wash Basin

Description	Code	£ Ex VAT	£ Inc VAT
Topino Wash Basin	95.100	263.00	315.60
Topino Pedestal	95.101	189.00	226.80

†While stocks last.

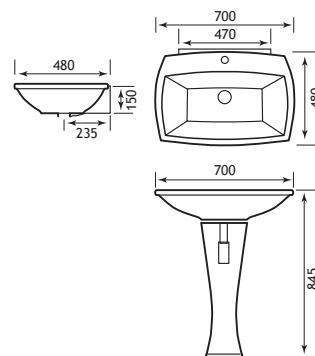

Alento - Ceramic Shelf

Warranty
10
Year



Conca Wall hung/Sit On basin			
Description	Code	£ Ex VAT	£ Inc VAT
Conca Wall hung/Sit On basin	95.133†	420.00	504.00

†While stocks last

All taps featured on these pages are for illustration purposes only.

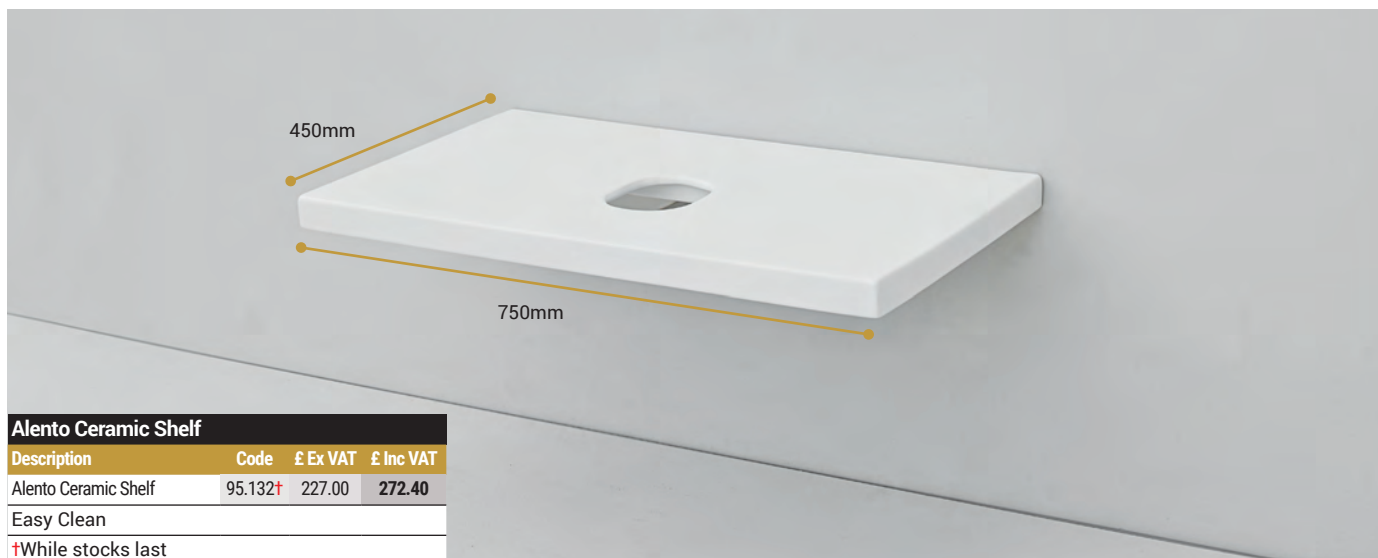

Alento Ceramic Shelf			
Description	Code	£ Ex VAT	£ Inc VAT
Alento Ceramic Shelf	95.132†	227.00	272.40
Easy Clean			

†While stocks last

To add the finishing touches to your bathroom, consider these highly stylised and robust ceramic accessories. Finished with a polished brilliant white surface, they will add that little something extra to make your design stand out from the crowd.



Alento Ceramic Brush Holder and Steel Brush

Description	Code	£ Ex VAT	£ Inc VAT
Alento Ceramic Brush Holder and Steel Brush	85.0021†	168.00	201.60

†While stocks last

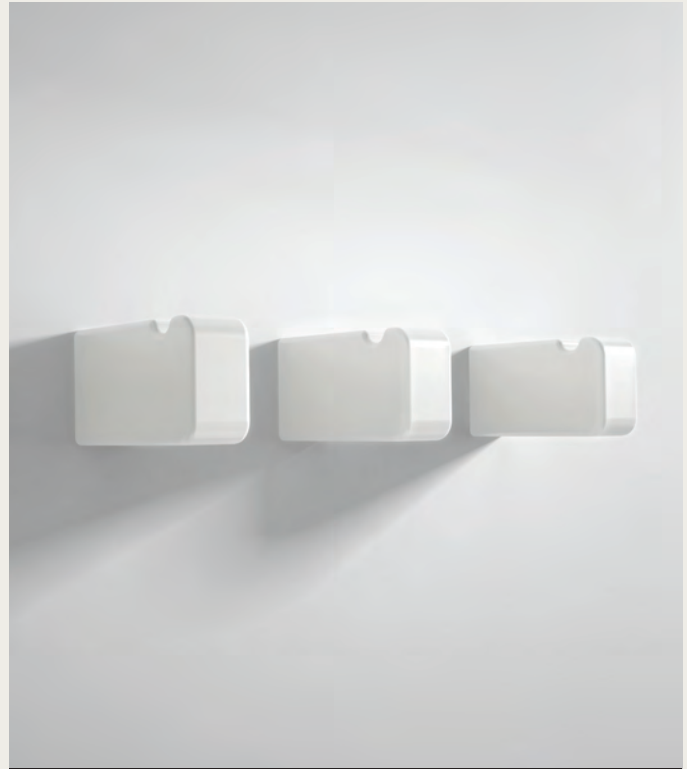

Alento Ceramic Hook

Description	Code	£ Ex VAT	£ Inc VAT
Alento Ceramic Hook (each)	85.0016†	53.00	63.60

†While stocks last

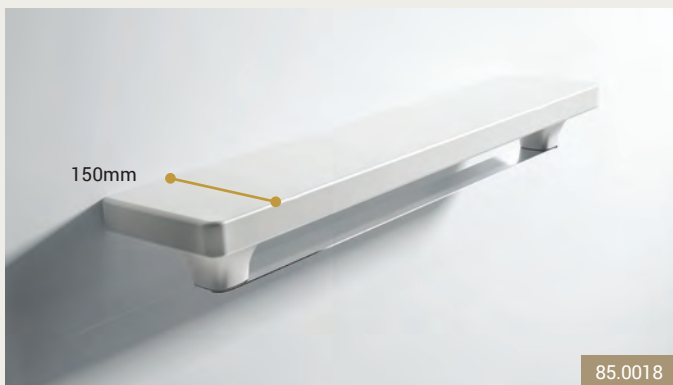

85.0018



85.0017

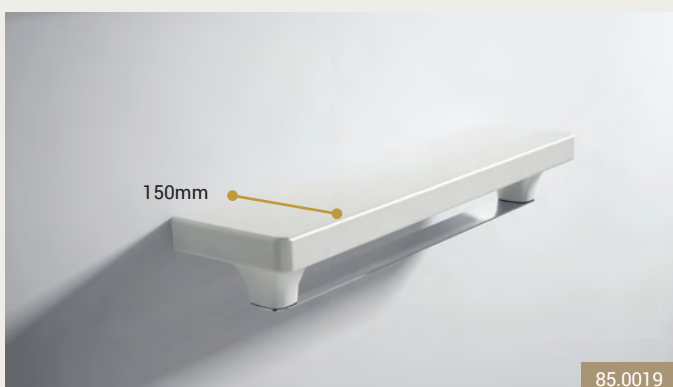

85.0019

Alento Ceramic Shelf and Steel Rail

Description	Code	£ Ex VAT	£ Inc VAT
Alento 750mm Ceramic Shelf and Steel Rail	85.0017†	177.00	212.40
Alento 550mm Ceramic Shelf and Steel Rail	85.0018†	146.00	175.20
Alento 420mm Ceramic Shelf and Steel Rail	85.0019†	123.00	147.60

†While stocks last



Accessories

Add the finishing touches to your bathroom or ensuite with a stylish range of accessories designed to complement your decor.

Contents

Alento range	300
Solid Brass Baskets	301
Salerno range	302 - 303
Genoa range	304 - 305
Rimini range	306 - 307
Rockingham range	308 - 309
Wastes	310
Bottle Traps, Levels,	311
Frames & Fixings	311



Alento & Davos

ALENTO STAINLESS STEEL ACCESSORIES



Alento Accessories			
Description	Code	£ Ex VAT	£ Inc VAT
Alento Hook	46.0000	19.00	22.80
Alento Double Hook	46.0001	36.00	43.20
Alento Toilet Roll Holder	46.0002	46.00	55.20
Alento Square Towel Ring	46.0003	80.00	134.40
Alento Round Towel Ring	46.0004	112.00	134.40
Alento Toilet Brush	46.0005	99.00	118.80
Alento Glass Shelf	46.0006	119.00	142.80
Alento 600mm Towel Rail	46.0007	66.00	79.20
Alento 800mm Towel Rail	46.0008	72.00	86.40

FEATURES

- Hidden fixings
- Made of stainless steel
- Polished finish



46.0001



46.0006



46.0002



46.0003



46.0007/8



46.0005



46.0000



46.0004

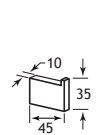

46.0000

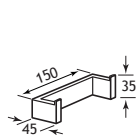

46.0001

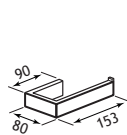

46.0002

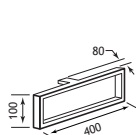

46.0003

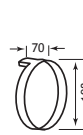

46.0004

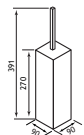

46.0005

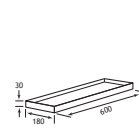

46.0006

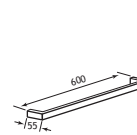

46.0007

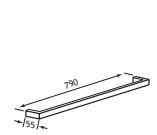

46.0008

DAVOS



Corner Glass Shelves

Description (Width x Depth x Height mm)	Code	£ Ex VAT	£ Inc VAT
Davos corner 320x320x1180 glass shelves	56.1052	226.00	271.20



56.1052

Solid Brass Baskets

SOLID BRASS BASKETS



52.213



52.205



52.210



52.202



52.209



52.208



52.206



52.207

Solid Brass Baskets				
Description	Dimensions width x projection	Code	£ Ex VAT	£ Inc VAT
Single corner basket	197 x 197 x 76	52.201	34.00	40.80
Double corner basket	345 x 195x 195	52.202	81.00	97.20
Rectangular wall basket	261 x 120 x 90	52.203	40.00	48.00
Double basket	275 x 155 x 310	52.205	94.00	112.80
Corner basket	210 x 210 x 110	52.206	47.00	56.40
Rectangular basket	360 x 95 x 150	52.207	55.00	66.00
Rectangular basket	265 x 125 x 55	52.208	48.00	57.60
Rectangular basket	200 x 120 x 45	52.209	40.00	48.00
Double corner basket	175 x 175 x 270	52.210	66.00	79.20
Corner basket	205 x 205 x 110	52.211	54.00	64.80
Double Rectangular hanging basket	275 x 125 x 510	52.213	129.00	154.80
Bath Rack	850 x 198 x 91	52.214	142.00	170.40

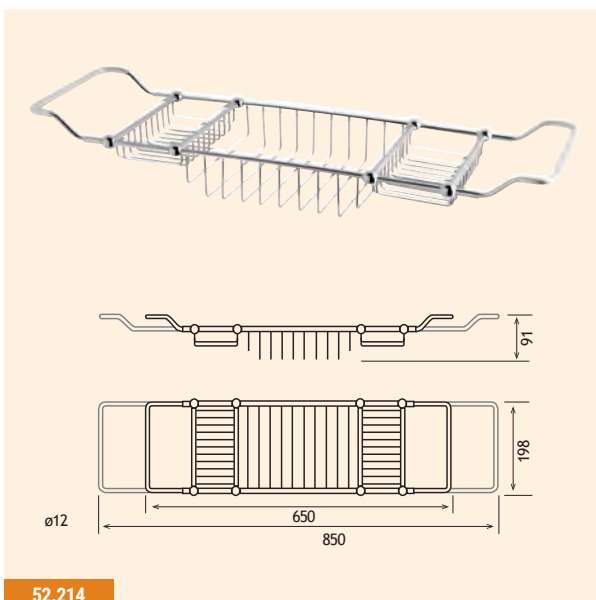

52.214



52.209



52.211

Salerno

SALERNO SOLID BRASS ACCESSORIES



FEATURES

- Made of solid brass
- A Choice of a bright chrome finish or matt smooth black
- Meticulously polished to produce mirror-like finish (chrome only)



52.020

NEW



52.215



52.021

NEW

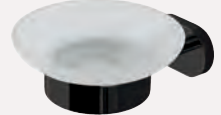

52.216



52.032

NEW



52.220

NEW



52.023



52.218



52.025

NEW



52.219



52.024

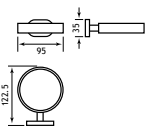

52.020

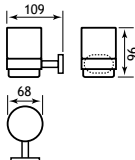

52.032

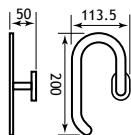

52.025

52.219

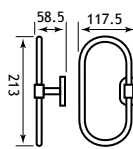

52.024

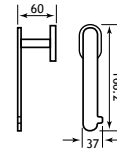

52.023

52.218

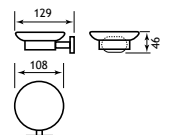

52.021

52.216

SALERNO SOLID BRASS ACCESSORIES



Pictured with Cheverney WC, see page 180.

Salerno Solid Brass Accessories				
Description	Dimensions width x projection	Code	£ Ex VAT	£ Inc VAT
Tumbler Holder	95 x 113	52.020	15.00	18.00
Tumbler Holder Matt Smooth Black	95 x 113	52.215	15.00	18.00
Soap Dish	108 x 129	52.021	15.00	18.00
Soap Dish Matt Smooth Black	108 x 129	52.216	15.00	18.00
Robe Hook	56 x 50	52.022	12.00	14.40
Robe Hook Matt Smooth Black	56 x 50	52.217	12.00	14.40
Toilet Roll Holder	166 x 60	52.023	18.00	21.60
Toilet Roll Holder Matt Smooth Black		52.218	18.00	21.60
Towel Ring	213 x 118	52.024	21.00	25.20
Towel Holder	200 x 50	52.025	31.00	37.20
Towel Holder Matt Smooth Black	200 x 50	52.219	31.00	37.20
450mm Single Towel Rail	513 x 60	52.026	51.00	61.20
Single Towel Rail	666 x 60	52.027	57.00	68.40
Single Towel Rail Matt Smooth Black	666 x 60	52.221	66.00	79.20
450mm Double Towel Rail	513 x 110	52.028	66.00	79.20
600mm Double Towel Rail	666 x 110	52.029	78.00	93.60
Towel Rack with Bar	666 x 215	52.030	154.00	184.80
Glass Shelf	500 x 115	52.031	31.00	37.20
Glass Brush Holder	68 x 109	52.032	24.00	28.80
Glass Brush Holder Matt Smooth Black	68 x 109	52.220	24.00	28.80

FEATURES

- Made of solid brass
- Meticulously polished to produce mirror-like finish (chrome only)
- Bright chrome or matt smooth black finish



52.221



52.028



52.026



52.030



52.031



52.027



52.029



52.022



52.217

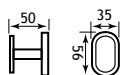

52.022

52.217

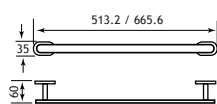

52.026/27

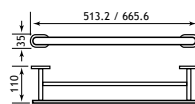

52.028/29

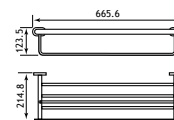

52.030

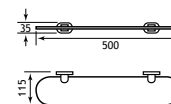

52.031

Genoa

GENOA SOLID BRASS ACCESSORIES



Pictured with Cheverny, see page 180.

FEATURES

- Made of solid brass
- Meticulously polished to produce mirror-like finish
- Bright chrome finish

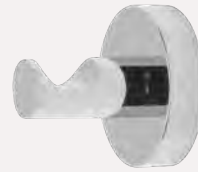

52.001



52.002



52.003



52.004

Can be freestanding or wall mounted



52.005



52.006



52.007

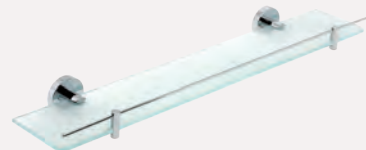

52.008



52.009



52.010



52.011

Each rail moves independently

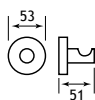

52.001

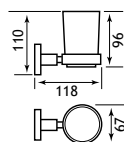

52.002

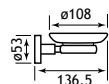

52.003

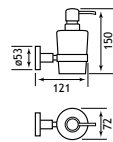

52.004

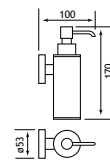

52.005

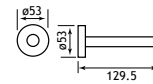

52.006

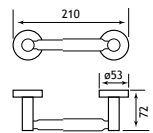

52.007

GENOA SOLID BRASS ACCESSORIES



Pictured with Cheverney basin, see page 181.

Genoa Solid Brass Accessories				
Description	Dimensions width x projection	Code	£ Ex VAT	£ Inc VAT
Robe Hook	52 x 50	52.001	13.00	15.60
Tumbler Holder	67 x 118	52.002	17.00	20.40
Glass Soap Dispenser	72 x 130	52.004	30.00	36.00
Toilet Roll Holder	52 x 130	52.006	16.00	19.20
Spindle Toilet Roll Holder	210 x 70	52.007	28.00	33.60
Metal Brush Holder**	92 diameter	52.013	65.00	78.00
Glass Brush Holder	112 x 153	52.012	26.00	31.20
Soap Dish	108 x 138	52.003	17.00	20.40
Metal Soap Dispenser	52 x 100	52.005	41.00	49.20
Double Split Towel Rail*	52 x 420	52.011	27.00	32.40
Double Towel Rail	643 x 154	52.010	56.00	67.20
Single Towel Rail	643 x 70	52.009	32.00	38.40
Glass Shelf with Barrier	596 x 126	52.008	30.00	36.00
Metal Towel Ring	190 x 170 x 57	52.014	25.00	30.00
Wiper	-	52.015	21.00	25.20
Covered Toilet Roll Holder	-	52.016	32.00	38.40

*Each rail moves independently. **Can be floor standing or wall hanging. If wall hanging projection increases to 106mm. Width measurements are to the outside face of each unit i.e. to the end of the brackets where applicable.

FEATURES

- Made of solid brass
- Meticulously polished to produce mirror-like finish
- Bright chrome finish



52.012

Can be freestanding or wall mounted



52.013



52.014



52.015

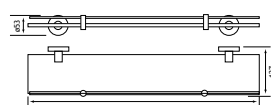

52.008

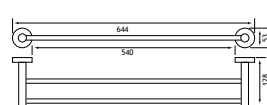

52.010

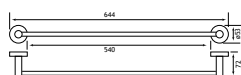

52.009



52.011

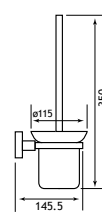

52.012

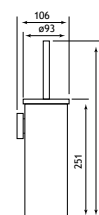

52.013

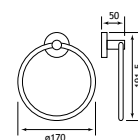

52.014

Rimini

Rimini Solid Brass				
Description	Dimensions width x projection	Code	£ Ex VAT	£ Inc VAT
Robe Hook	52 x 55	52.101	14.00	16.80
Tumbler Holder	67 x 118	52.102	18.00	21.60
Glass Soap Dispenser	72 x 130	52.104	33.00	39.60
Toilet Roll Holder	141 x 51	52.106	16.00	19.20
Spindle Toilet Roll Holder	207 x 72	52.107	29.00	34.80
Glass Brush Holder	115 x 155	52.112	29.00	34.80
Metal Brush Holder**	93 x 107	52.113	69.00	82.80
Soap Dish	110 x 141	52.103	18.00	21.60
Metal Soap Dispenser	52 x 100	52.105	45.00	54.00
Double Split Towel Rail*	52 x 420	52.011	28.00	33.60
Double Towel Rail	643 x 129	52.110	67.00	80.40
Single Towel Rail	640 x 71	52.109	35.00	42.00
Glass Shelf with Barrier	600 x 125	52.108	33.00	39.60
Metal Towel Ring	165 x 162 x 50	52.114	28.00	33.60
Wiper	-	52.115	35.00	42.00
Covered Toilet Roll Holder	-	52.116	33.00	39.60

*Each rail moves independently. **Can be floor standing or wall hanging. If wall hanging projection increases to 106mm. Width measurements are to the outside face of each unit i.e. to the end of the brackets where applicable.

FEATURES

- Made of solid brass
- Meticulously polished to produce mirror-like finish
- Bright chrome finish



52.106



52.114

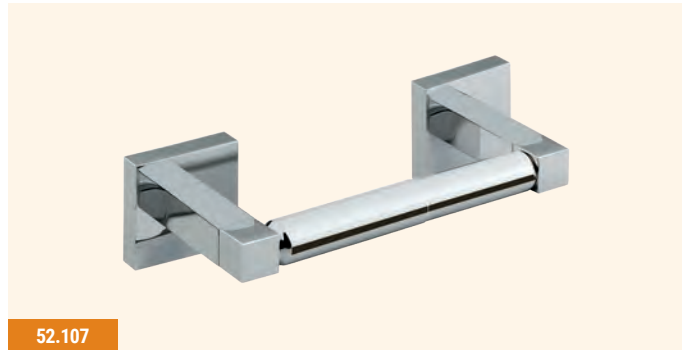

52.107



52.101



52.103



52.105

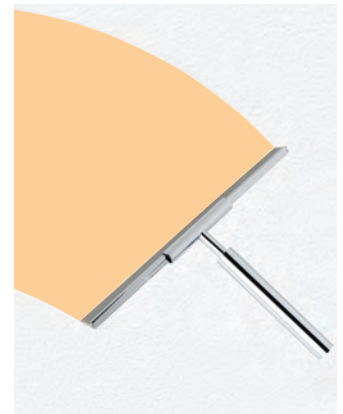

52.102



52.104



52.115

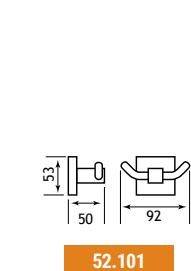

52.101

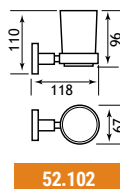

52.102

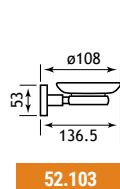

52.103

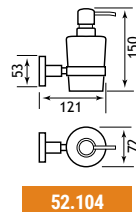

52.104

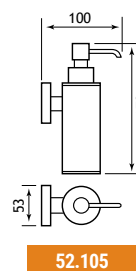

52.105

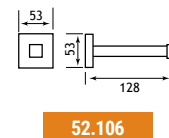

52.106

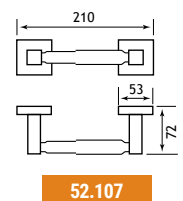

52.107

RIMINI SOLID BRASS ACCESSORIES



Pictured with Cheverney basin, see page 167.

Can be freestanding or wall mounted



52.112



52.113

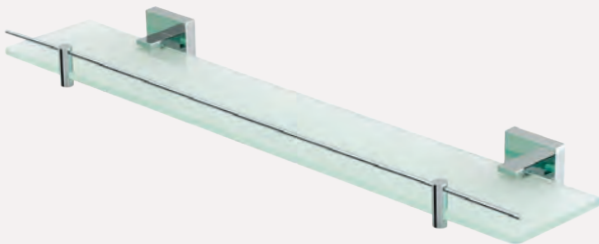

52.108

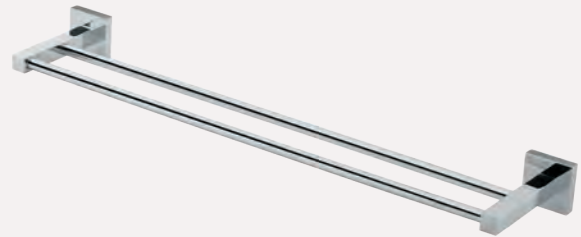

52.110



52.109



52.111

Each rail moves independently

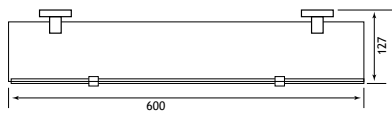

52.108

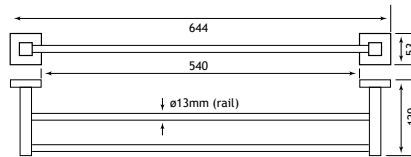

52.110

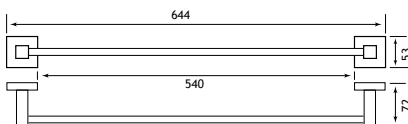

52.109

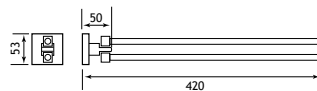

52.111

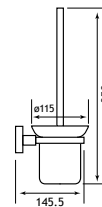

52.112

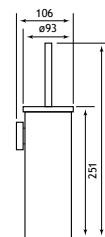

52.113

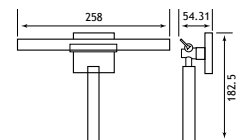

52.115

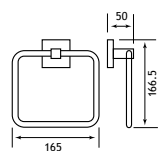

52.114

Rockingham

Rockingham Solid Brass			
Description (Chrome)	Code	£ Ex VAT	£ Inc VAT
Rockingham Robe Hook	52.040	30.00	36.00
Rockingham Tumbler Holder	52.041	46.00	55.20
Rockingham Double Tumbler Holder	52.042	65.00	78.00
Rockingham Soap Dish	52.043	46.00	55.20
Rockingham Towel Ring	52.044	41.00	49.20
Rockingham Toilet Roll Holder	52.045	49.00	58.80
Rockingham Single Towel Rail	52.046	65.00	78.00
Rockingham Double Towel Rail	52.047	109.00	130.80
Rockingham Towel Shelf	52.048	191.00	229.20
Rockingham Glass Shelf	52.049	70.00	84.00
Rockingham Toilet Brush Holder	52.050	61.00	73.20
Rockingham Covered Toilet Roll Holder	52.051	54.00	64.80

FEATURES

- Constructed from solid brass
- Polished chrome finish
- Traditional design
- Easy to fit



52.040



52.041



52.050



52.043



52.042



52.044



52.045



52.051

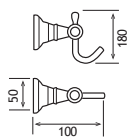

52.040

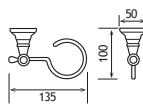

52.041

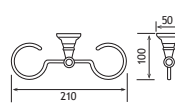

52.042

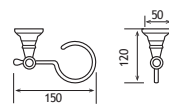

52.043

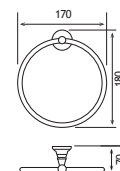

52.044

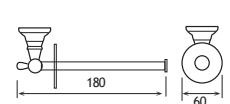

52.045

Rockingham

ROCKINGHAM SOLID BRASS ACCESSORIES



52.046



52.047

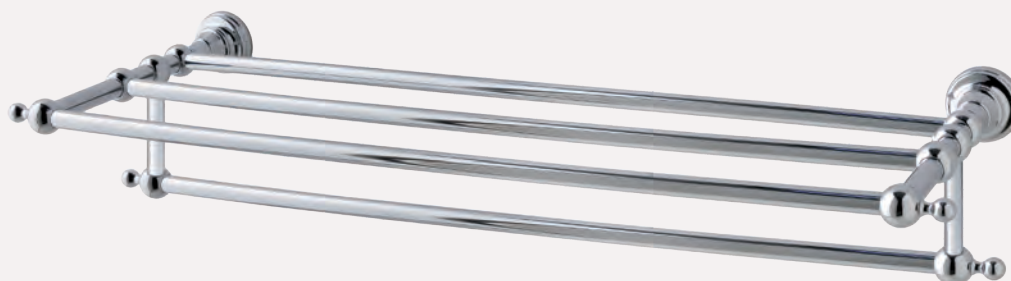

52.048

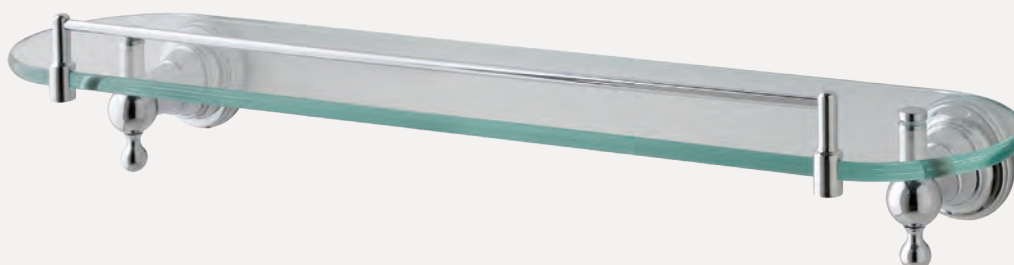

52.049

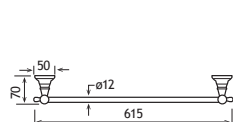

52.046

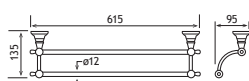

52.047

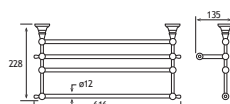

52.048

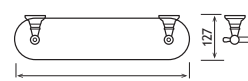

52.049

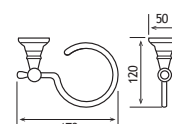

52.050

Waste Range

Bath Wastes			
Description (Chrome)	Code	£ Ex VAT	£ Inc VAT
Waste and Overflow	82.0006	61.00	73.20
Exposed Bath Pop Up Waste	25.0001	112.00	134.40
Luxury Bath Pop Up Waste & Overflow	25.0003	30.00	36.00
Luxury Bath Pop Up Waste & Overflow	41.2008	32.00	38.40
Bath Pop Up Waste & Overflow	56.2071	25.00	30.00
Superior Bath Pop Up Waste & Overflow	56.2072	28.00	33.60
Extended Bath Pop-up Waste & Overflow	98.0008	27.00	32.40

Bath Wastes			
Description (Chrome)	Code	£ Ex VAT	£ Inc VAT
Bath Combined Waste & Overflow	41.2009	13.00	15.60
Push Button Bath Waste & Overflow	7.0011	57.00	68.40
Square Sprung Plug Bath Waste	98.0006	31.00	37.20
Ceramic Top Bath Waste	45.0001	39.00	46.80
Flipper Bath Waste	25.0007	27.00	32.40
Square Sprung Plug Bath Waste	98.0006	31.00	37.20
Extended Bath Pop-up Waste & Overflow	98.0008	27.00	32.40

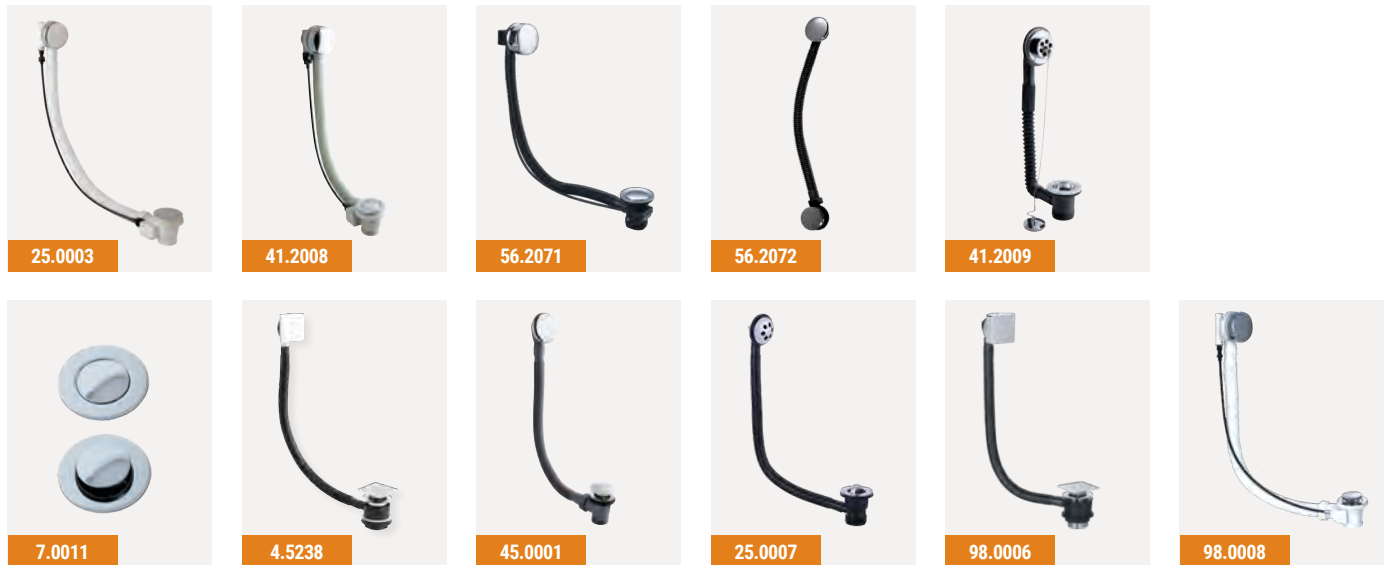

Basin Wastes			
Description (Chrome)	Code	£ Ex VAT	£ Inc VAT
Push Button Basin Waste	25.0002	15.00	18.00
Push Button Basin Waste	56.2073	19.00	22.80
Push Button Basin Waste	41.2010	25.00	30.00
Flip Top Basin Waste - Unslotted	25.0005	12.00	14.40
Flip Top Basin Waste - Slotted	25.0006	12.00	14.40
Ceramic Top Basin Waste	45.0000	17.00	20.40
Brass Flip Top Basin Waste	4.5241*	16.00	19.20

Basin Wastes			
Description (Chrome)	Code	£ Ex VAT	£ Inc VAT
Sprung Plug Basin Waste Unslotted	98.0002*	14.00	16.80
Basin Waste Link Chain Brass Plug	98.0003**	12.00	14.40
Basin Waste, Ball Chain, Solid Plug	98.0007**	11.00	13.20

Other Wastes			
Description (Chrome)	Code	£ Ex VAT	£ Inc VAT
Contract Sink Waste	4.5213*	8.00	9.60

*While stocks last.

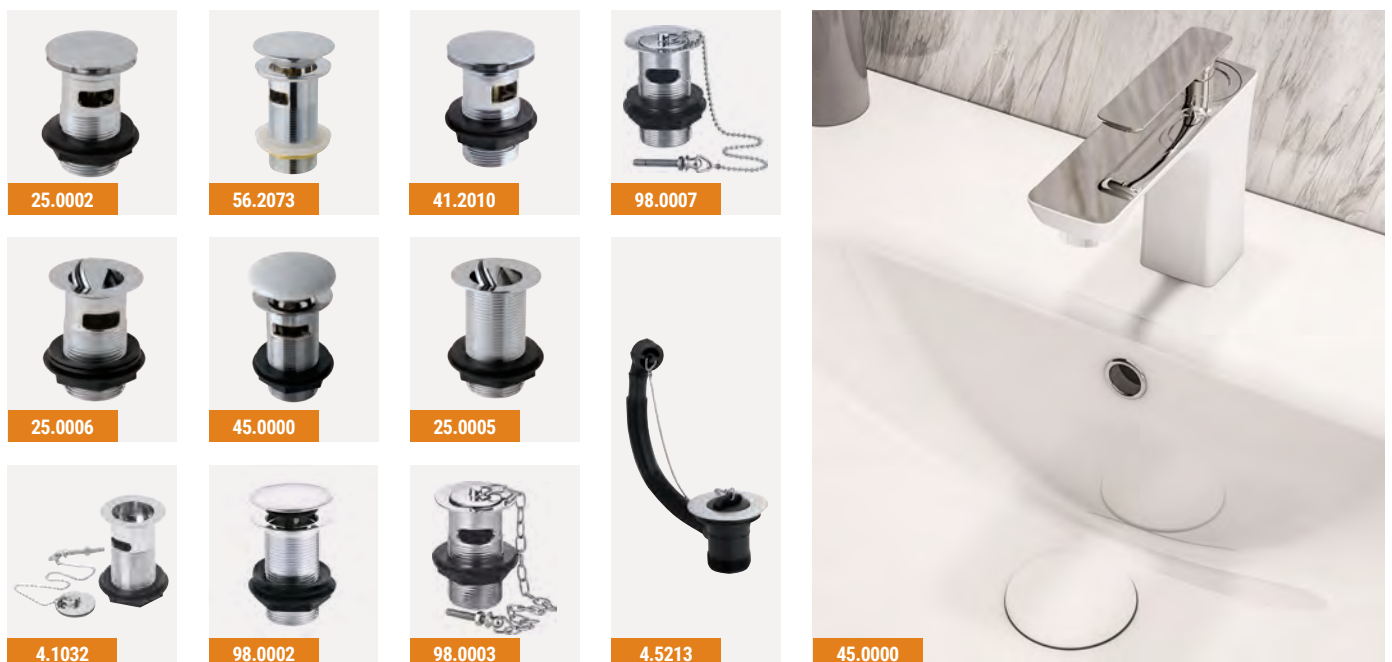

Bottle Traps, Levers, Frames & Fixings

Bottle Traps

Description	Code	£ Ex VAT	£ Inc VAT
1.25" Bottle Trap inc Extender Tube	98.0017	30.00	36.00
Square Bottle Trap and Extension Tube Chrome	93.0050	48.00	57.60
Minimalist Bottle Trap	93.0065	26.00	31.20



98.0017



93.0050



93.0065

Levers

Description	Code	£ Ex VAT	£ Inc VAT
Metal Universal WC Lever	98.0011	7.00	8.40
Ceramic Handle WC Lever	98.0012	10.00	12.00



98.0011



98.0012

Frames & Fixings

Description	Code	£ Ex VAT	£ Inc VAT
Wall Hung Pan/Bidet Brackets	21.149B	140.00	168.00
Mirage Frame 310 x 345	73.0003	115.00	138.00
L-Shape Wall Hung Pan/Bidet Brackets	90.0010	56.00	67.20

Description	Code	£ Ex VAT	£ Inc VAT
Fischer Bolts Set - Basin to Wall	9.201	11.00	13.20
Fischer Bolts Set - Pan to Floor - Top Fixing	9.202	7.00	8.40
Fischer cloakroom/corner basin brackets	9.203	12.00	14.40
Fischer Bolts Set - Pan to Floor - Side Fixing Fitting System For Sanitaryware	9.204	1616.00	19.21



21.149b



73.0003

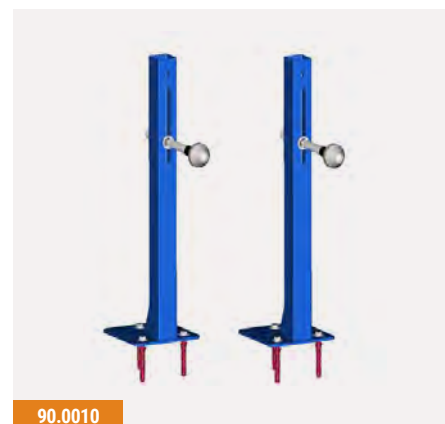

90.0010



Vanity

Units both stylish and practical, many with soft close systems on doors and drawers. New stone resin cast tops give opportunities to create a stunning impression.

Contents	
Bonito Range	314 - 320
Bonito Slab	316 - 319
Bonito Corner Units	320
Castilla Drawer	321
Diamante Units	322 - 323
Faro Vanity Units	324 - 327
Madrid Vanity Units	328 - 331
Oslo Vanity Units	332 - 366
Oslo Combination Unit	353
Oslo Max	352
Oslo Combination Furniture	353-357
Oslo Semi Recessed	358-359
Oslo Tall Cistern Unit	360 - 362
Oslo Reduced Depth	363
Oslo Wall Hung	364 - 366
Seville Tableau	367 - 368
Sorrento Slab Units	369 - 371
Sorrento Vanity Units	372 - 374
Sorrento Wall-Hung Basins & Units	375 - 382
Sherwood Vanity Units	383
Bath Panels	384 -385
Diamante Bath Panels	386-387
Seats	387



Bonito 120 Range



Bonito 120 high gloss white combination with Bonito 120 cast top (left or right handed). The 60cm cornice has two halogen lamps and a shaver socket.

1200mm Bonito Unit			
Size	Code	£ Ex VAT	£ Inc VAT
Bonito 60cm WC unit**	1.029	236.00	283.20
Bonito 60cm basin unit**	1.028	213.00	255.60
Bonito 120cm plinth (height 70mm)	1.039	16.00	19.20
Bonito cast cut out panel	1.062	23.00	27.60
Bonito 120 cast top LH	51.001	248.00	297.60
Bonito 120 cast top RH	51.002	248.00	297.60
Bonito 60cm wall unit - door	1.034	179.00	214.80
Bonito 60cm mirror †	1.036	103.00	123.60
Diamante 60cm Cornice***	1.204	158.00	189.60
Vantage Plain Hidden Cistern CP Push Button	17.001	133.00	159.60
Eastbrook Jacket Hidden Cistern - Bottom Inlet	53.001	82.00	98.40
Vantage Hidden Cistern with Jacket	17.3029	155.00	186.00

† NB. mirror must be fitted with cornice. *7.0015 trap and unslotted basin waste recommended for installation, see below for details. **Plinth must be ordered separately. ***During the life of this brochure the lights may change to LED.

Basin Unit

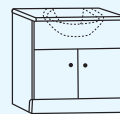

The upper panel is supplied uncut (for semi recessed basin)

1.028 / 1.037		
Width	Depth	Height
600mm	305mm	800mm

*Height excluding countertop and basin

Wall Cupboard

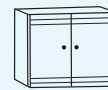

with two doors

1.034		
Width	Depth	Height
600mm	176mm	700mm

Base Unit with Drawer



All drawers have metal runners and all doors have metal adjustable hinges. RH shown

Left Hand - 1.031 (OR) Right Hand - 1.030		
Width	Depth	Height
300mm	305mm	800mm

*excluding countertop

Concealed Cistern WC unit



With two removable fascia panels. The panels are not pre-drilled or cut (for greater flexibility when fitting)

1.029 / 1.037		
Width	Depth	Height
600mm	305mm	800mm

*Height excluding countertop and basin

Wall Cupboard



1.032 (reversible)		
Width	Depth	Height
300mm	176mm	700mm

Mirror & Cornice

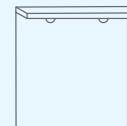

With halogen lamps and pull-cord operation

1.036 (mirror) / 1.204 (cornice)	
Width	Height
600mm	800mm

*Cornice sold separately

Extras

Description	Code	£ Ex VAT	£ Inc VAT
Trap for external overflow kit	7.0015	16.00	19.20
Flip Top Basin Waste - Unslotted	25.0005	12.00	14.40

Spares

Description	Code	£ Ex VAT	£ Inc VAT
Bonito 60cm upper panel	1.043	65.00	78.00
Bonito 60cm Lower panel	1.044	65.00	78.00
Bonito/Madrid Handle	1.925	9.00	10.80

FEATURES

- Separate shaver socket
- CAST MARBLE TOPS**
- Made of 75% natural marble stone
- Repairable if chipped
- Seamless surface, easy to maintain

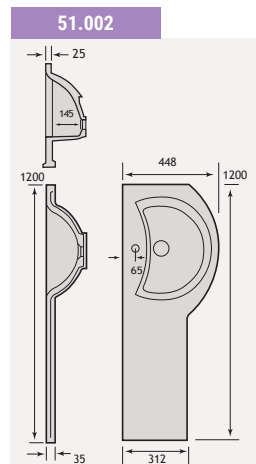
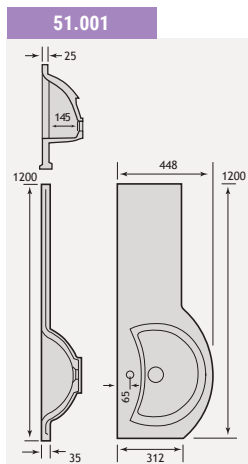

Bonito 120 Range

Bonito with laminate top

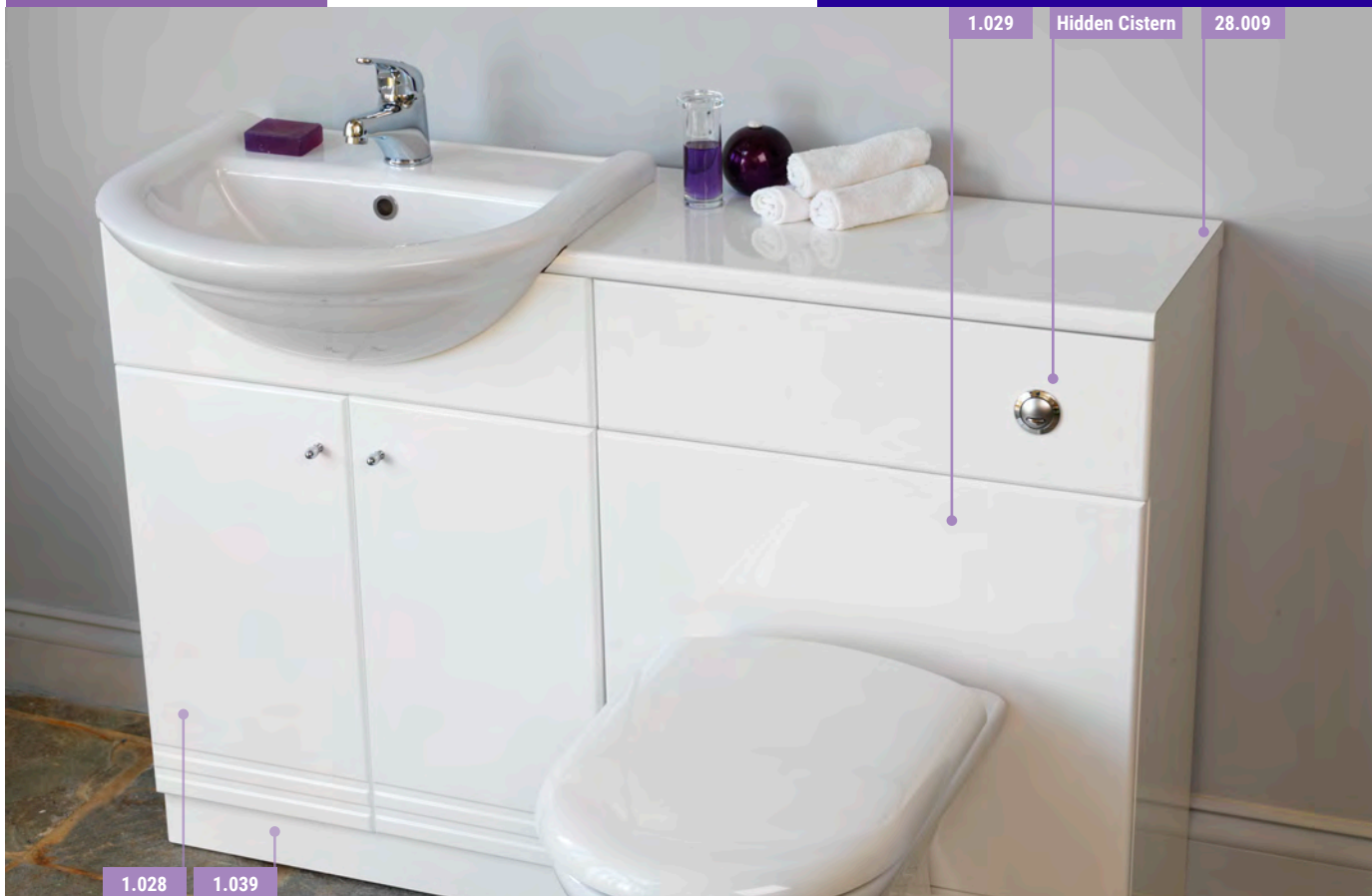

BONITO 120 UNITS

Bonito 120 high gloss white with laminate top. There are numerous combinations using laminate tops and optional 300mm left and right hand base units with corresponding 300mm wall cupboards.

We offer a wide range of other sanitaryware options to suit most tastes. Refer to the sanitaryware section for many different designs on back to wall WC pans and semi recessed basins.

Bonito Range Of Fitted Bathroom Furniture

Description	Code	£ Ex VAT	£ Inc VAT
Bonito 60cm basin unit **	1.028	213.00	255.60
Bonito 60cm WC unit **	1.029	236.00	283.20
Bonito 30cm RH base drawer unit	1.030	130.00	156.00
Bonito 30cm LH base drawer unit	1.031	130.00	156.00
Bonito 30cm wall unit - door	1.032	102.00	122.40
Bonito 60cm wall unit - door	1.034	179.00	214.80
Bonito 60cm mirror	1.036	103.00	123.60
Diamante 60cm Cornice	1.204	158.00	189.60
Bonito 30cm plinth (height 70mm)	1.011	12.00	14.40
Bonito 60cm plinth (height 70mm)	1.037	14.00	16.80
Bonito 90cm plinth (height 70mm)	1.038	15.00	18.00
Bonito 120cm plinth (height 70mm)	1.039	16.00	19.20
Bonito 150cm plinth (height 70mm)	1.040	18.00	21.60
Bonito 180cm plinth (height 70mm)	1.041	19.00	22.80
Plain infill panel 30 x 81cm	1.042	60.00	72.00
Vantage Plain Hidden Cistern CP Push Button	17.001	133.00	159.60
Eastbrook Jacket Hidden Cistern - Bottom Inlet	53.001	82.00	98.40
Vantage Hidden Cistern with Jacket	17.3029	155.00	186.00

NB White mirrors are supplied with chrome shrouds around halogen lights. All handles chrome. **Plinth must be ordered separately.

Bonito Wc Unit And High Gloss White Top

Description	Code	£ Ex VAT	£ Inc VAT
Bonito 600mm MDF WC cover	1.063	46.00	55.20
Bonito 60cm WC unit	1.029	236.00	283.20
Bonito 60cm plinth (height 70mm)	1.037	14.00	16.80
Vantage Plain Hidden Cistern CP Push Button	17.001	133.00	159.60
Eastbrook Jacket Hidden Cistern - Bottom Inlet	53.001	82.00	98.40
Vantage Hidden Cistern with Jacket	17.3029	155.00	186.00

Laminate Tops: 28Mm Thickness, Gloss White

Description	Code	£ Ex VAT	£ Inc VAT
Laminate Tops Gloss 1000 x 310 mm	28.006	51.00	61.20
Laminate Tops Gloss 1200 x 310mm	28.009	59.00	70.80
Laminate Tops Gloss 1500 x 310 mm	28.007	59.00	70.80
Laminate Tops Gloss 2000 x 310 mm	28.008	100.00	120.00



Bonito WC with high gloss white wooden top

Check List ✓

Units	Tops - cast (51.001/2) + (1.062)	Tops - semi recessed basin + (28.006/9/7/8)	Plinths	Hidden cistern	BTW pan	Taps	Cornice	Wall Cupboards
<input type="checkbox"/>	<input type="checkbox"/>	<input type="checkbox"/>	<input type="checkbox"/>	<input type="checkbox"/>	<input type="checkbox"/>	<input type="checkbox"/>	<input type="checkbox"/>	<input type="checkbox"/>

Bonito Slab Range

BONITO SLAB UNITS



Bonito Slab Tall Cupboard			
Description	Code	£ Ex VAT	£ Inc VAT
Bonito 30cm tall cupboard, 2 door LH*	1.296	311.00	373.20
Bonito 30cm tall cupboard with drawer RH*	1.297	311.00	373.20
Bonito 30cm tall cupboard, 2 door LH*	1.295	283.00	339.60
Bonito 30cm tall cupboard, 2 door RH*	1.299	283.00	339.60

*Plinth must be ordered separately

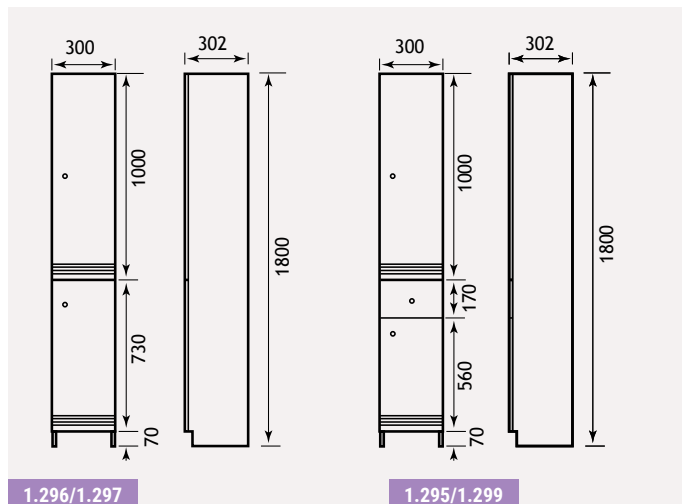
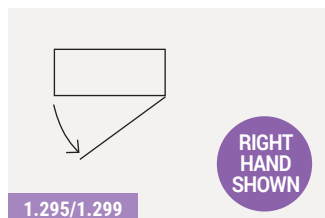
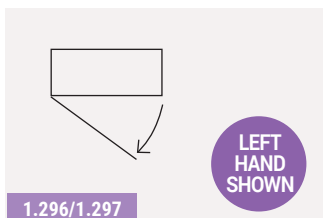

Bonito Slab Range

WALL UNITS & MIRRORS

Mirror - 1.036
Cornice 1.204



FEATURES

- Separate shaver socket

Mirror (1.036) & CORNICE (1.204) with pull-cord operation

W: 600mm • H 700mm

Description	Code	£ Ex VAT	£ Inc VAT
Bonito 60cm mirror*	1.036	103.00	123.60
Diamante 60cm Cornice**	1.204	158.00	189.60

*Cornice sold separately

*Mirror must be fitted with 1.204 cornice.
**During the life of this brochure the lights may change to LED.

Wall Unit - 1.032

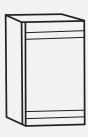

300mm WALL CUPBOARD (1.032) (reversible)

W: 300mm • D: 176mm • H: 700mm

Description	Code	£ Ex VAT	£ Inc VAT
Bonito 30cm wall unit - door	1.032	102.00	122.40

All handles chrome.

Wall Unit - 1.034

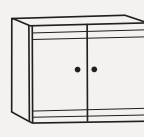

600mm WALL CUPBOARD (1.034) with two doors

W: 600mm • D: 176mm • H: 700mm

Description	Code	£ Ex VAT	£ Inc VAT
Bonito 60cm wall unit - door	1.034	179.00	214.80

All handles chrome.

TOPS

Mirror (1.036) & CORNICE (1.204) with pull-cord operation

W: 600mm • H 700mm

Description	Code	£ Ex VAT	£ Inc VAT
Bonito Single basin top	51.018	185.00	222.00
Bonito Slab top 600	51.021	89.00	106.80
Bonito Slab top 900	51.020	117.00	140.40
Bonito Slab top 1200	51.019	154.00	184.80
Trap for external overflow kit	7.0015	16.00	19.20
Flip Top Basin Waste - Unslotted	25.0005	12.00	14.40

*Due to depth of the waste area, the trap for external overflow kit & a flip top basin waste (unslotted) are recommended for installation.

FEATURES - Cast Marble Tops

- Made of 75% natural marble stone
- Repairable if chipped
- Seamless surface, easy to maintain

51.018

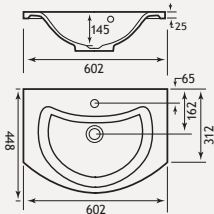

51.021

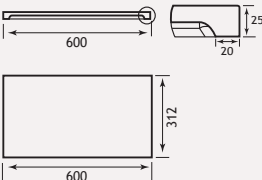

51.020

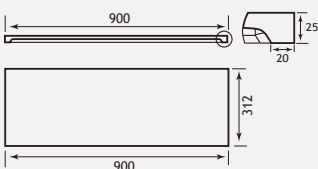

51.019

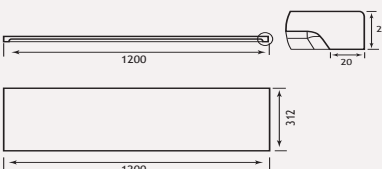

BASE UNITS

Concealed Cistern WC Unit - 1.029

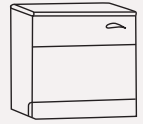

Concealed Cistern WC unit (1.029) with two removable fascia panels. The panels are not pre-drilled or cut (for greater flexibility when fitting)

W: 600mm • D 305mm • H 800mm**

Description	Code	£ Ex VAT	£ Inc VAT
Bonito 60cm base cupboard with drawer*	1.029	236.00	283.20

*Plinth must be ordered separately
**Excluding countertop and basin

Base Unit - 1.030/031

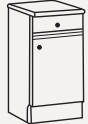

300mm Base Unit (1.030/031) with drawer (order LH or RH). All drawers have metal runners and all doors have metal adjustable hinges. RH shown

W: 300mm • D 305mm • H 800mm**

Description	Code	£ Ex VAT	£ Inc VAT
Bonito 30cm RH base drawer unit*	1.030	130.00	156.00
Bonito 30cm LH base drawer unit*	1.031	130.00	156.00

*Plinth must be ordered separately
**Height measurement excluding countertop

1.062 1.042

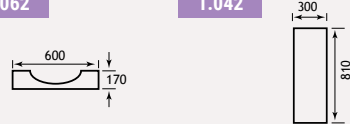

Cast Panel & Plain Infill

Description	Code	£ Ex VAT	£ Inc VAT
Bonito cast cut out panel	1.062	23.00	27.60
Plain infill panel 30 x 81cm	1.042	60.00	72.00

Basin Unit - 1.028

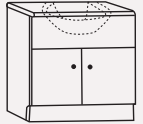

Upper panel is supplied uncut (for semi recessed basin).

W: 600mm • D 305mm • H 800mm**

Description	Code	£ Ex VAT	£ Inc VAT
Bonito 60cm basin unit*	1.028	213.00	255.60

*Plinth must be ordered separately
**Height measurement excluding countertop

Base Unit - 1.298



W: 600mm • D 305mm • H 800mm**

Description	Code	£ Ex VAT	£ Inc VAT
Bonito 60cm base cupboard with drawer*	1.298	219.00	262.80

*Plinth must be ordered separately
**Height measurement excluding countertop

Extras

Description	Code	£ Ex VAT	£ Inc VAT
Vantage Plain Hidden Cistern CP Push Button	17.001	133.00	159.60
Eastbrook Jacket Hidden Cistern - Bottom Inlet	53.001	82.00	98.40
Vantage Hidden Cistern with Jacket	17.3029	155.00	186.00

Plinths

Description	Code	£ Ex VAT	£ Inc VAT
30cm plinth (height 70mm)	1.011	12.00	14.40
60cm plinth (height 70mm)	1.037	14.00	16.80
90cm plinth (height 70mm)	1.038	15.00	18.00
120cm plinth (height 70mm)	1.039	16.00	19.20
150cm plinth (height 70mm)	1.040	18.00	21.60
180cm plinth (height 70mm)	1.041	19.00	22.80

Bonito Slab Range

BONITO SLAB UNITS



Description	Code	£ Ex VAT	£ Inc VAT
Bonito 30cm tall cupboard, 2 door LH*	1.296	311.00	373.20
Bonito 30cm tall cupboard with drawer RH*	1.297	311.00	373.20
Bonito 30cm tall cupboard, 2 door LH*	1.295	283.00	339.60
Bonito 30cm tall cupboard, 2 door RH*	1.299	283.00	339.60

*Plinth must be ordered separately

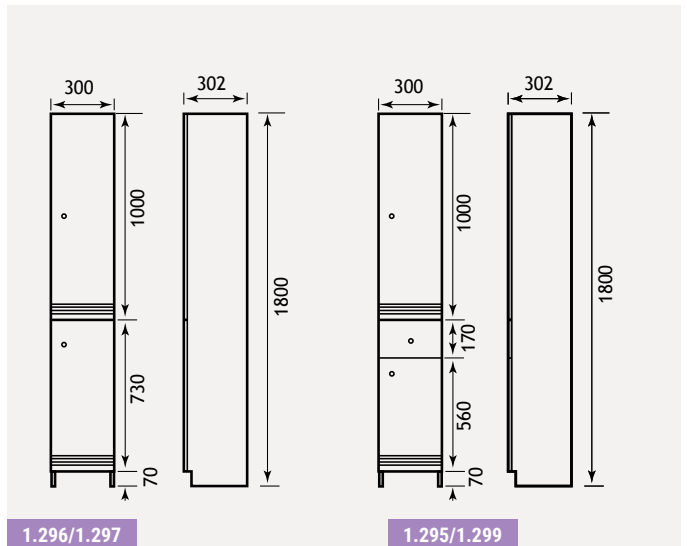
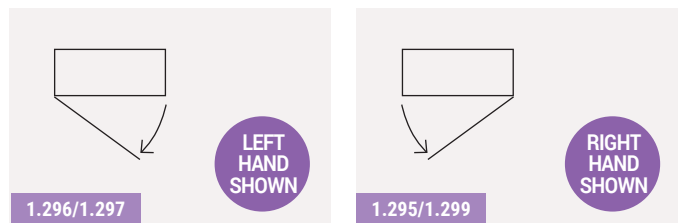

Bonito Slab Range

WALL UNITS & MIRRORS

Mirror - 1.036
Cornice 1.204



FEATURES

- Separate shaver socket

Mirror (1.036) & CORNICE (1.204) with pull-cord operation

W: 600mm • H 700mm

Description	Code	£ Ex VAT	£ Inc VAT
Bonito 60cm mirror*	1.036	103.00	123.60
Diamante 60cm Cornice**	1.204	158.00	189.60

*Cornice sold separately

*Mirror must be fitted with 1.204 cornice.
**During the life of this brochure the lights may change to LED.

Wall Unit - 1.032

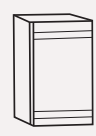

300mm WALL CUPBOARD (1.032) (reversible)

W: 300mm • D: 176mm • H: 700mm

Description	Code	£ Ex VAT	£ Inc VAT
Bonito 30cm wall unit - door	1.032	102.00	122.40

All handles chrome.

Wall Unit - 1.034

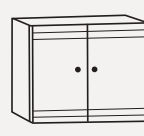

600mm WALL CUPBOARD (1.034) with two doors

W: 600mm • D: 176mm • H: 700mm

Description	Code	£ Ex VAT	£ Inc VAT
Bonito 60cm wall unit - door	1.034	179.00	214.80

All handles chrome.

TOPS

Mirror (1.036) & CORNICE (1.204) with pull-cord operation

W: 600mm • H 700mm

Description	Code	£ Ex VAT	£ Inc VAT
Bonito Single basin top	51.018	185.00	222.00
Bonito Slab top 600	51.021	89.00	106.80
Bonito Slab top 900	51.020	117.00	140.40
Bonito Slab top 1200	51.019	154.00	184.80
Trap for external overflow kit	7.0015	16.00	19.20
Flip Top Basin Waste - Unslotted	25.0005	12.00	14.40

*Due to depth of the waste area, the trap for external overflow kit & a flip top basin waste (unslotted) are recommended for installation.

FEATURES - Cast Marble Tops

- Made of 75% natural marble stone
- Repairable if chipped
- Seamless surface, easy to maintain

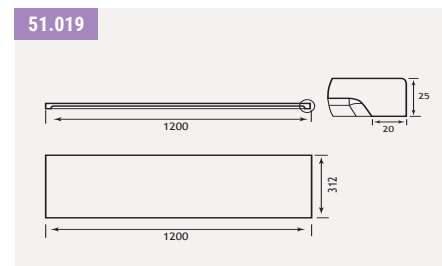
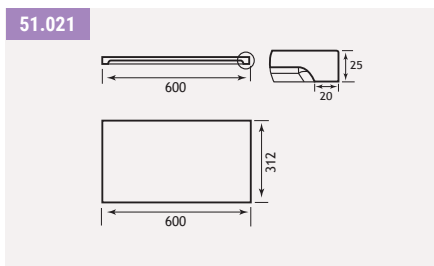
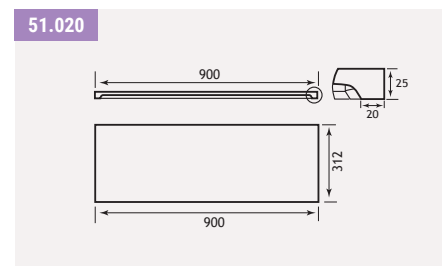
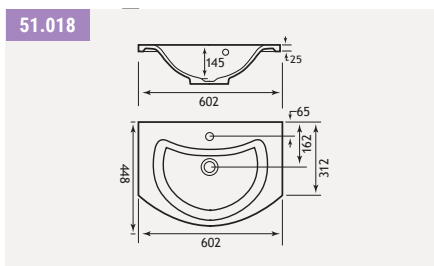

BASE UNITS

Concealed Cistern WC Unit - 1.029

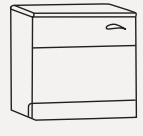

Concealed Cistern WC unit (1.029) with two removable fascia panels. The panels are not pre-drilled or cut (for greater flexibility when fitting)

W: 600mm • D 305mm • H 800mm**

Description	Code	£ Ex VAT	£ Inc VAT
Bonito 60cm WC unit*	1.029	236.00	283.20

*Plinth must be ordered separately
**Excluding countertop and basin

Base Unit - 1.030/031

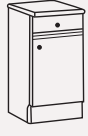

300mm Base Unit (1.030/031) with drawer (order LH or RH). All drawers have metal runners and all doors have metal adjustable hinges. RH shown

W: 300mm • D 305mm • H 800mm**

Description	Code	£ Ex VAT	£ Inc VAT
Bonito 30cm RH base drawer unit*	1.030	130.00	156.00
Bonito 30cm LH base drawer unit*	1.031	130.00	156.00

*Plinth must be ordered separately
**Height measurement excluding countertop

1.062 1.042

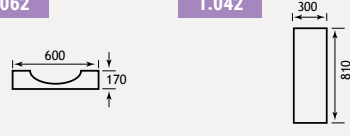

Cast Panel & Plain Infill

Description	Code	£ Ex VAT	£ Inc VAT
Bonito cast cut out panel	1.062	23.00	27.60
Plain infill panel 30 x 81cm	1.042	60.00	72.00

Basin Unit - 1.028

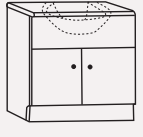

Upper panel is supplied uncut (for semi recessed basin).

W: 600mm • D 305mm • H 800mm**

Description	Code	£ Ex VAT	£ Inc VAT
Bonito 60cm basin unit*	1.028	213.00	255.60

*Plinth must be ordered separately
**Height measurement excluding countertop

Base Unit - 1.298



W: 600mm • D 305mm • H 800mm**

Description	Code	£ Ex VAT	£ Inc VAT
Bonito 60cm base cupboard with drawer*	1.298	219.00	262.80

*Plinth must be ordered separately
**Height measurement excluding countertop

Extras

Description	Code	£ Ex VAT	£ Inc VAT
Vantage Plain Hidden Cistern CP Push Button	17.001	133.00	159.60
Eastbrook Jacket Hidden Cistern - Bottom Inlet	53.001	82.00	98.40
Vantage Hidden Cistern with Jacket	17.3029	155.00	186.00

Plinths

Description	Code	£ Ex VAT	£ Inc VAT
30cm Plinth (height 70mm)	1.011	12.00	14.40
60cm plinth (height 70mm)	1.037	14.00	16.80
90cm plinth (height 70mm)	1.038	15.00	18.00
120cm plinth (height 70mm)	1.039	16.00	19.20
150cm plinth (height 70mm)	1.040	18.00	21.60
180cm plinth (height 70mm)	1.041	19.00	22.80

Bonito Corner Unit Range

BONITO CORNER UNITS

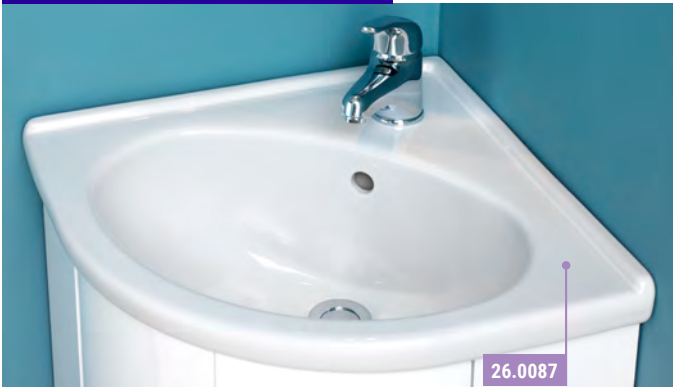

Bonito Corner Unit			
Description	Code	£ Ex VAT	£ Inc VAT
Bonito Corner unit base only	1.087	259.00	310.80
Bonito corner ceramic top 1TH White	26.0087	109.00	130.80
Biava Hi.Flow Basin Mono	93.0052	71.00	85.20
Mirror Options Option 1 (not shown)			
Corner mirror cupboard carcass	1.000	183.00	219.60
Option 2			
Corner mirror cupboard carcass	1.000	183.00	219.60
Corner cupboard light cornice*	1.002	70.00	84.00
Option 3			
Bonito Corner mirror with light*	1.088	139.00	166.80

*Can be handed left or right. *During the life of this brochure the lights may change to LED.

All you will ever need for the perfect corner solution. Each style is finished in high gloss white with a solid ceramic top. Both the corner cupboard and corner mirror have a light cornice with a single lamp, operated by a pull-cord.

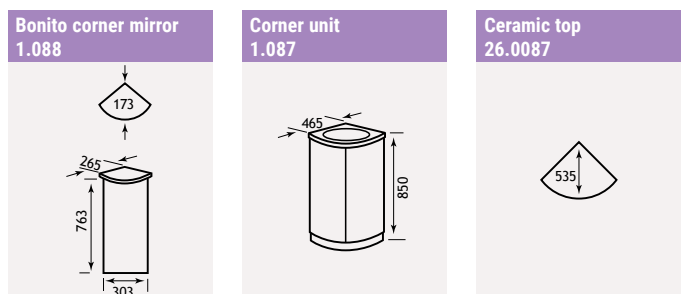

CASTILLA 50, 60 AND 80 DRAWER UNIT



Castilla 60 with Rondo sit-on basin



Castilla 60 with Barbro sit-on basin



Castilla 60 with Renata sit-on basin. Renata requires slotted waste



Castilla 60 with Natura sit-on basin



Castilla 60 with Pricilla sit-on basin

Castilla 50, 60 And 80 Drawer Unit

Description	Code	£ Ex VAT	£ Inc VAT
Castilla 50 drawer unit	1.286	234.00	280.80
Castilla 60 Drawer Unit	1.282	258.00	309.60
Castilla 80 Drawer Unit	1.283	308.00	369.60

Sit On Basins

Description	Code	£ Ex VAT	£ Inc VAT
Renata sit on basin 430	51.029	132.00	158.40
Natura sit on basin 500x400	51.030	147.00	176.40
Pricilla sit on basin 510x300	51.031	147.00	176.40
Rondo sit on basin 412	51.032	147.00	176.40
Barbro sit on basin 460	51.033	223.00	267.60

FEATURES

- Soft close system on drawer

FEATURES - Sit On Basins

- Made of 75% natural marble stone
- Repairable if chipped
- Seamless surface, easy to maintain

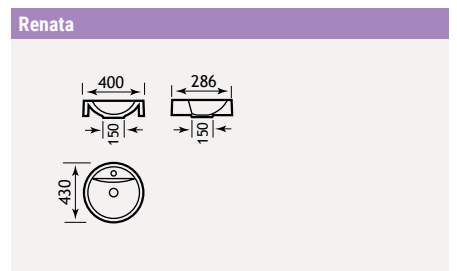
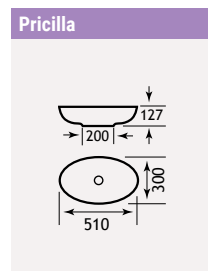
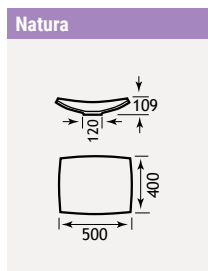
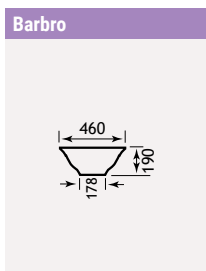
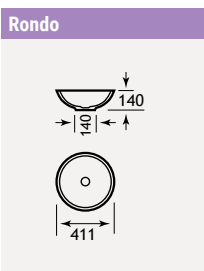

Diamante 110 Furniture

DIAMANTE 110



Right hand cast top shown



Left hand shown

Similar in design to the Bonito 120, the Diamante has a more contemporary look, a smaller depth at only 220mm and a stunning one-piece cast top available in either left or right hand versions. The Diamante 110 high gloss white combination is available with either right or left hand bowls - right hand shown, with Kompakt BTW pan.

Diamante 110 Base and Top

Description	Code	£ Ex VAT	£ Inc VAT
New Diamante 50cm WC unit	1.070	228.00	273.60
New Diamante 60cm basin unit	1.071	203.00	243.60
New Diamante 1090mm plinth	1.077	16.00	19.20
Diamante 110 cast top LH *	51.003	244.00	292.80
Diamante 110 cast top RH *	51.004	244.00	292.80
Diamante 50cm wall unit	1.254	179.00	214.80
Bonito 60cm mirror †	1.036	103.00	123.60
Diamante 60cm Cornice**	1.204	158.00	189.60
Prado 700 mono basin c/w click waste	56.2010	95.00	114.00

*Due to depth of the waste area, the trap for external overflow kit & a flip top basin waste (unslotted) are recommended for installation. ** During the life of this brochure the lights may change to LED.

FEATURES - CAST MARBLE TOPS

- Made of 75% natural marble stone
- Repairable if chipped
- Seamless surface, easy to maintain

FEATURES

- Separate shaver socket

For wall mirrors and cabinets see pages 378-401.

Extras

Description	Code	£ Ex VAT	£ Inc VAT
Trap for external overflow kit	7.0015	16.00	19.20
Flip Top Basin Waste - Unslotted	25.0005	12.00	14.40

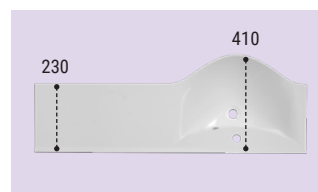

All 1096mm in length, 145mm depth to top of rim

Basin Unit

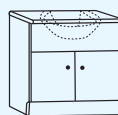

The upper panel is supplied cut for the Diamante 1150mm top

1.071	Width	Depth	Height
	600mm	225mm	810mm

*Excluding countertop and basin

Concealed Cistern WC unit

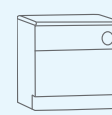

With two removable fascia panels. The panels are not pre-drilled or cut (for greater flexibility when fitting)

1.070	Width	Depth	Height
	495mm	225mm	810mm

*Height excluding countertop and basin

Mirror & Cornice

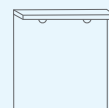

with halogen lamps and pull-cord operation

1.036 / 1.204	Width	Height
	600mm	706mm

*Cornice sold separately

Wall Cupboard

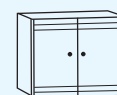

with two doors

1.254	Width	Depth	Height
	500mm	176mm	700mm

Extras

Description	Code	£ Ex VAT	£ Inc VAT
Uncut top panel for new Diamante 60cm basin unit	1.079	60.00	72.00
Diamante WC top panel	1.072	65.00	78.00
Diamante WC bottom panel	1.073	65.00	78.00
Top panel for new Diamante 60cm basin unit	1.074	60.00	72.00

For hidden cisterns see pages 236-247.

Diamante WC & Corner Units

DIAMANTE WC UNIT



A compact, stand-alone 500mm WC unit available with a high gloss white MDF top.

Diamante WC Unit

Description	Code	£ Ex VAT	£ Inc VAT
Oslo WC unit lid	1.075	41.00	49.20
New Diamante 50cm WC unit	1.070	228.00	273.60
Diamante 490mm plinth	1.078	13.00	15.60
Vantage Plain Hidden Cistern CP Push Button	17.001	133.00	159.60
Eastbrook Jacket Hidden Cistern - Bottom Inlet	53.001	82.00	98.40
Vantage Hidden Cistern with Jacket	17.3029	155.00	186.00
Kompact BTW pan	27.0321	120.00	144.00
Kompact soft close seat	21.1151	111.00	133.20

Note: other BTW pans are available, see Sanitary section pages 224-225. Plinth sold separately

DIAMANTE CORNER UNIT

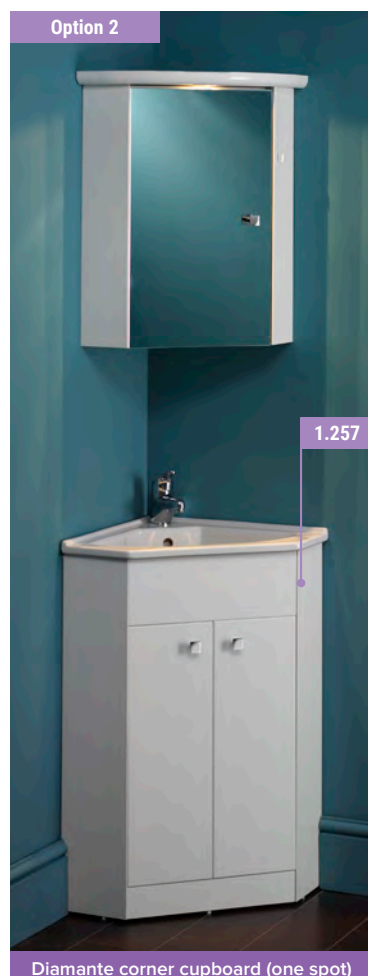
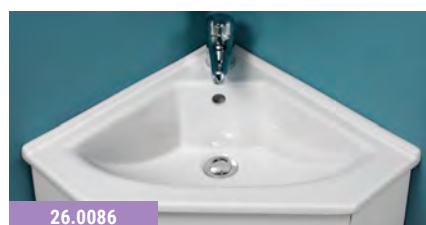

Diamante Corner Unit

Description	Code	£ Ex VAT	£ Inc VAT
Diamante corner unit	1.257	238.00	285.60
Diamante corner basin 1TH	26.0086	112.00	134.40
Mirror Option 1 (not shown)			
Corner mirror cupboard carcass	1.000	183.00	219.60
Mirror Option 2			
Corner mirror cupboard carcass *	1.000	183.00	219.60
Corner cupboard light cornice **	1.002	70.00	84.00
Mirror Option 3			
Bonito Corner mirror with light	1.088	139.00	166.80

*Can be handed left or right. **During the life of this brochure the lights may change to LED.

For wall mirrors and cabinets see pages 390-413.

Corner cupboard light cornice 1.002

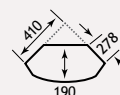

Corner mirror cupboard 1.000

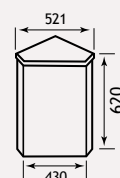

Corner unit base with ceramic top 1.257 & 26.0086

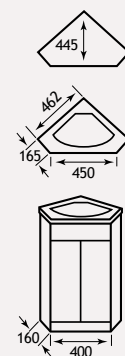

Faro 39 Range

FARO 39



A modern design of a traditional concept with soft close hinges on doors only, adjustable feet and stone resin cast top.

Faro 39 Base And Top

Description	Code	£ Ex VAT	£ Inc VAT
Faro 39cm base unit	1.269	189.00	226.80
Oslo/Faro 39 cast top *	51.005	120.00	144.00
Faro 39cm mirror †	1.270	95.00	114.00
Faro 39cm cornice **	1.277	136.00	163.20

† NB. mirror must be fitted with cornice. *Due to depth of the waste area, the trap for external overflow kit & a flip top basin waste (unslotted) are recommended for installation. **During the life of this brochure the lights may change to LED.

FEATURES

- Soft close system on doors
- Separate shaver socket
- Adjustable legs 120-130mm

FEATURES - Cast Marble Tops

- Made of 75% natural marble stone
- Repairable if chipped
- Seamless surface, easy to maintain

For wall mirrors and cabinets see pages 390-413

Extras

Description	Code	£ Ex VAT	£ Inc VAT
Trap for external overflow kit	7.0015	16.00	19.20
Flip Top Basin Waste - Unslotted	25.0005	12.00	14.40



The Faro range features adjustable legs. 120-130mm

51.011

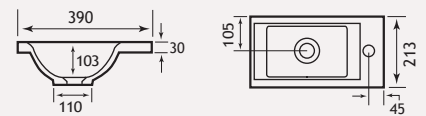

For wall mirrors and cabinets see pages 390-413

1.270/1.277

*NB Mirror and cornice height does not include plastic shroud

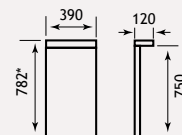

1.269

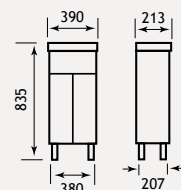

Faro 58 Range

FARO 58



A modern design of a traditional concept with soft close hinges on doors only, adjustable feet and stone resin cast top.

Faro 58 Base And Top

Description	Code	£ Ex VAT	£ Inc VAT
Sorrento/Faro 56cm base unit	1.512	310.00	372.00
Faro 58cm cast top *	51.011	177.00	212.40
Faro 58cm wave action cornice **	1.272	201.00	241.20
Faro 58cm mirror †	1.271	115.00	138.00

† NB. mirror must be fitted with cornice. *Due to depth of the waste area, the trap for external overflow kit & a flip top basin waste (unslotted) are recommended for installation. **During the life of this brochure the lights may change to LED.

FEATURES

- Soft close system on doors and drawers
- Separate shaver socket
- Adjustable legs 120-130mm

FEATURES - Cast Marble Tops

- Made of 75% natural marble stone
- Repairable if chipped
- Seamless surface, easy to maintain

Extras

Description	Code	£ Ex VAT	£ Inc VAT
Trap for external overflow kit	7.0015	16.00	19.20
Flip Top Basin Waste - Unslotted	25.0005	12.00	14.40

51.011

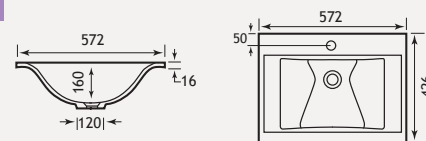

For wall mirrors and cabinets see pages 390-413

1.272 / 1.271

*NB Mirror and cornice height does not include plastic shroud

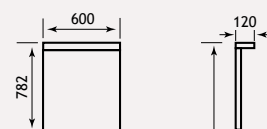

1.512

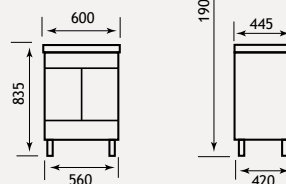

Faro 80 Range

FARO 80

Option 1



A modern design of a traditional concept with soft close hinges on doors only, adjustable feet and cast tops.

Faro 80 - Base and Top

Description	Code	£ Ex VAT	£ Inc VAT
Sorrento/Faro 76cm base unit	1.514	351.00	421.20
Faro 80cm cast top *	51.012	201.00	241.20
Mirror Options 1			
Faro 80cm mirror †	1.273	133.00	159.60
Faro 80cm wave action cornice ††	1.274	233.00	279.60
Mirror Options 2			
Faro 39cm mirror †	1.270	95.00	114.00
Faro 39cm cornice ††	1.277	136.00	163.20
Faro 20cm Wall Cupboard (each)**	1.268	126.00	151.20

† NB. mirror must be fitted with cornice. *Due to depth of the waste area, the trap for external overflow kit & a flip top basin waste (unslotted) are recommended for installation. **NB For Option 2 this line needs to be doubled if two cupboards required i.e £252.00 plus VAT. ††During the life of this brochure the lights may change to LED.

Extras

Description	Code	£ Ex VAT	£ Inc VAT
Trap for external overflow kit	7.0015	16.00	19.20
Flip Top Basin Waste - Unslotted	25.0005	12.00	14.40

Option 2



FEATURES

- Soft close system on doors
- Separate shaver socket
- Adjustable legs 120-130mm

FEATURES - CAST MARBLE TOPS

- Made of 75% natural marble stone
- Repairable if chipped
- Seamless surface, easy to maintain

The Faro range features adjustable legs. 120-130mm



51.012

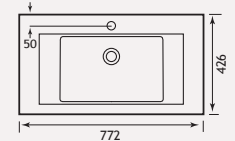
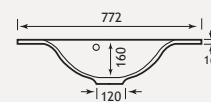

For wall mirrors and cabinets

(Option 1) 1.273/1.274

*NB Mirror and cornice height does not include plastic shroud

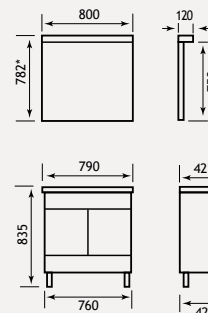

1.514

(Option 2) 1.270/1.277/1.268

*NB Mirror and cornice height does not include plastic shroud

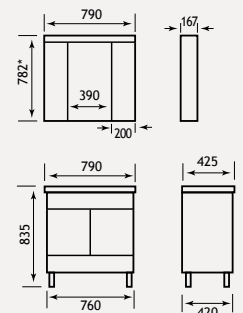

1.514

Faro 100 Range

FARO 100

Option 2



A modern design of a traditional concept with soft close hinges on doors only, adjustable feet and cast tops.

Faro 100 Base and Top

Description	Code	£ Ex VAT	£ Inc VAT
Sorrento/Faro 96cm base unit	1.516	419.00	502.80
Faro 100cm cast top *	51.013	227.00	272.40

Mirror Options 1

Faro 100cm mirror †	1.275	153.00	183.60
Faro 100cm wave action cornice ††	1.276	258.00	309.60

Mirror Options 2

Faro 58cm mirror †	1.271	115.00	138.00
Faro 58cm wave action cornice ††	1.272	201.00	241.20
Faro 20cm Wall Cupboard (each)**	1.268	126.00	151.20

† NB. mirror must be fitted with cornice. *Due to depth of the waste area, the trap for external overflow kit & a flip top basin waste (unslotted) are recommended for installation. **NB For Option 2 this line needs to be doubled if two cupboards required ie £252.00 plus VAT. ††During the life of this brochure the lights may change to LED.

Extras

Description	Code	£ Ex VAT	£ Inc VAT
Trap for external overflow kit	7.0015	16.00	19.20
Flip Top Basin Waste - Unslotted	25.0005	12.00	14.40

Option 1



FEATURES

- Soft close system on doors
- Separate shaver socket
- Chrome spotlights
- Adjustable legs 120-130mm

FEATURES - Cast Marble Tops

- Made of 75% natural marble stone
- Repairable if chipped
- Seamless surface, easy to maintain

51.013

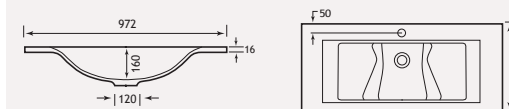

For wall mirrors and cabinets see pages 390-413

(Option 1) 1.275/1.276

*NB Mirror and cornice height does not include plastic shroud

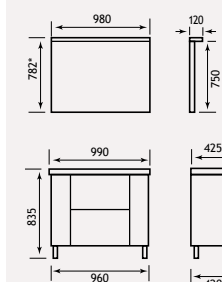

1.516

(Option 2) 1.271/1.272/1.268

*NB Mirror and cornice height does not include plastic shroud

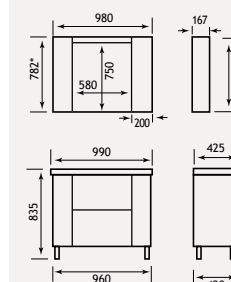

1.516

Madrid 43 Range

MADRID 43



22.0000

1.052

Madrid 430mm high gloss white base unit

Ideal for tight spaces - perfect for cloakrooms and en-suites. The mirror is supplied complete with a light cornice and a useful shelf.
During the life of this brochure the lights may change to LED.

FEATURES

- Mirror has integral shelf and light cornice



430mm mirror and light cornice



22.0000

430mm Madrid Unit With One-Piece Ceramic Top

Description	Code	£ Ex VAT	£ Inc VAT
Madrid 41cm base unit	1.082	162.00	194.40
Madrid 43cm 1TH ceramic top	22.0000	67.00	80.40
43cm mirror 1 light *	1.086	174.00	208.80
Biava Mini basin mono c/w clicker waste	56.2052	83.00	99.60

*During the life of this brochure the lights may change to LED.

1.086

*NB Mirror and cornice height does not include plastic shroud

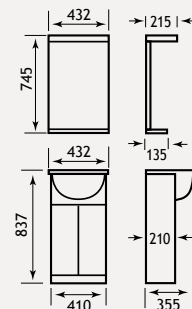

1.082

Madrid 60 Range

MADRID 60



Madrid 600mm high gloss white base unit. Newlyn tap illustrated.

Plenty of storage with two drawers and two cupboards. The mirror has two halogen lamps and a shaver socket, both with pull cord operation. The cornice is supplied separately to the mirror.

FEATURES

- Separate shaver socket
- FEATURES - CAST MARBLE TOPS**
- Made of 75% natural marble stone
- Repairable if chipped
- Seamless surface, easy to maintain

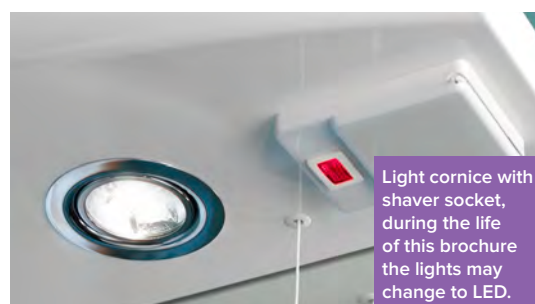

Light cornice with shaver socket, during the life of this brochure the lights may change to LED.



Madrid 60 1TH cast top

600mm Madrid Unit

Description	Code	£ Ex VAT	£ Inc VAT
Madrid 58cm base unit	1.083	219.00	262.80
Madrid 60 1TH ***	51.086	144.00	172.80
Diamante 60cm mirror *	1.203	103.00	123.60
Diamante 60cm Cornice **	1.204	158.00	189.60
Trap for external overflow kit	7.0015	16.00	19.20
Flip Top Basin Waste - Unslotted	25.0005	12.00	14.40

*Mirror must be fitted with a cornice. **During the life of this brochure the lights may change to LED. ***Trap 7.0015 and Unslotted Basin Waste 25.0005 recommended for installation.

For wall mirrors and cabinets see pages 390-413

1.203/1.204

*NB Mirror and cornice height does not include plastic shroud

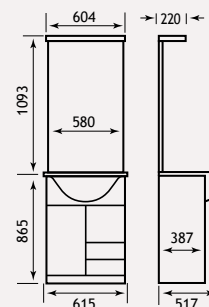

1.083

Madrid 80 Range



MADRID 80

Option 1

1.204

1.015

1.217

51.087

1.084

1.203

800mm Madrid high gloss white unit with cast top, 800mm mirror and 800mm cornice



1.204



Option 2

1.209

1.208

51.087

1.084

A flexible combination, the base unit can be used with an 800mm mirror and cornice (the cornice has three lamps and a shaver socket), or with a 600mm mirror (two lamps and a shaver socket) with a 200mm wall cupboard and single shelf (shown left).

FEATURES

- Separate shaver socket

FEATURES - CAST MARBLE TOPS

- Made of 75% natural marble stone
- Repairable if chipped
- Seamless surface, easy to maintain

800mm Madrid Unit			
Description	Code	£ Ex VAT	£ Inc VAT
Madrid 70cm base unit	1.084	269.00	322.80
Madrid 80 1TH ***	51.087	158.00	189.60
Trap for external overflow kit	7.0015	16.00	19.20
Flip Top Basin Waste - Unslotted	25.0005	12.00	14.40
Mirror Options 1			
Diamante 60cm mirror *	1.203	103.00	123.60
Diamante 60cm Cornice**	1.204	158.00	189.60
Madrid 20cm wall unit	1.015	103.00	123.60
Diamante/Madrid 20cm single shelf	1.217	65.00	78.00
Mirror Options 2			
Diamante 80cm mirror *	1.208	119.00	142.80
Diamante 80cm Cornice**	1.209	194.00	232.80

*Mirror must be fitted with a cornice. **During the life of this brochure the lights may change to LED.***Trap 7.0015 and Unslotted Basin Waste 25.0005 recommended for installation.

For matching bath panels see page 137.
For wall mirrors and cabinets see pages 390-413.

1.203 / 1.204

1.208 / 1.209

*NB Mirror and cornice height does not include plastic shroud

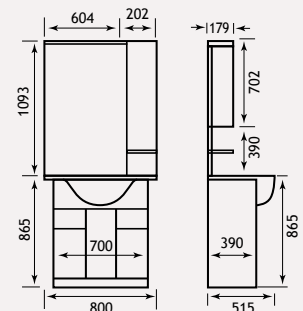

1.084

Madrid 100 Range



1000mm Madrid high gloss white unit with cast top, 600mm mirror and cornice with left and right hand wall cupboards and single shelves.

1000mm Madrid Unit

Description	Code	£ Ex VAT	£ Inc VAT
Madrid 90cm base unit	1.085	328.00	393.60
Madrid 100 1TH ***	51.088	172.00	206.40
Trap for external overflow kit	7.0015	16.00	19.20
Flip Top Basin Waste - Unslotted	25.0005	12.00	14.40

Mirror Options 1

Diamante 60cm mirror *	1.203	103.00	123.60
Diamante 60cm Cornice ††	1.204	158.00	189.60
Madrid 20cm wall unit (each)**	1.015	103.00	123.60
Diamante/Madrid 20cm single shelf (each)**	1.217	65.00	78.00

**NB For Option 1 this line needs to be doubled if two single shelves required i.e. £130.00 plus VAT, if two wall units required ie £206.00 ex VAT.

*Mirror must be fitted with a cornice. †† During the life of this brochure the lights may change to LED. ***Trap 7.0015 and Unslotted Basin Waste 25.0005 recommended for installation.



Space, elegance and lots of storage. The 1000mm unit has the benefit of either a 1000mm mirror with cornice (three lamps and a shaver socket), or a 600mm mirror with cornice (two lamps and a shaver socket) with two 200mm wall cupboards and single shelves.

FEATURES

- Separate shaver socket

FEATURES - CAST MARBLE TOPS

- Made of 75% natural marble stone
- Repairable if chipped
- Seamless surface, easy to maintain

1.203 / 1.204

1.208 / 1.209

1.213 / 1.214

*NB Mirror and cornice height does not include plastic shroud

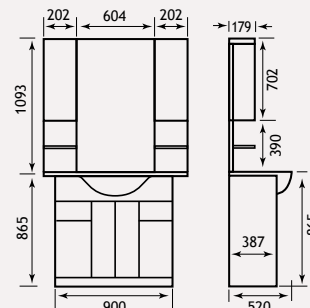

1.085

Description	Code	£ Ex VAT	£ Inc VAT
-------------	------	----------	-----------

Mirror Options 2 (not shown)

Diamante 80cm mirror *	1.208	119.00	142.80
Diamante 80cm Cornice ††	1.209	194.00	232.80
Madrid 20cm wall unit	1.015	103.00	123.60
Diamante/Madrid 20cm single shelf	1.217	65.00	78.00

Mirror Options 3

Diamante 100cm mirror *	1.213	133.00	159.60
Diamante 100cm Cornice ††	1.214	207.00	248.40

Oslo 39 - Door Unit Range

OSLO 39 HIGH WHITE GLOSS TWO DOOR MODEL



OSLO 39 ANTHRACITE TWO DOOR MODEL



Oslo High Gloss White creates a stunning impression, a quality carcass with soft close systems on both the doors and drawers. New minimalist stone resin-cast tops allow more depth to the basin than ceramic sinks and are easy to keep clean. Available in various combinations the Oslo range will grace any bathroom.

Oslo Matt Anthracite gives off a modern feel, made of a quality carcass with soft close systems on both the doors and drawers. New minimalist stone resin-cast tops allow more depth to the basin than ceramic sinks and are easy to keep clean. Available in various combinations the Oslo range will grace any bathroom.

Oslo 39 Unit White Two Door Unit

Description	Code	£ Ex VAT	£ Inc VAT
Oslo 39cm base unit	1.064	174.00	208.80
Oslo/Faro 39 cast top *	51.005	120.00	144.00
Oslo 30cm tall cupboard, 2 door	1.294	283.00	339.60

Oslo White WC Unit

Description	Code	£ Ex VAT	£ Inc VAT
Oslo WC unit only	1.287	228.00	273.60
Oslo WC unit lid	1.075	41.00	49.20
Oslo WC unit plinth	1.288	10.00	12.00

Extras

Description	Code	£ Ex VAT	£ Inc VAT
Trap for external overflow kit	7.0015	16.00	19.20
Flip Top Basin Waste - Unslotted	25.0005	12.00	14.40

*Due to depth of the waste area, the trap for external overflow kit & a flip top basin waste (unslotted) are recommended for installation.

FEATURES

- Soft close system on doors and drawers

FEATURES - CAST MARBLE TOPS

- Made of 75% natural marble stone
- Repairable if chipped
- Seamless surface, easy to maintain

Oslo 39 Unit Anthracite Two Door Unit

Description	Code	£ Ex VAT	£ Inc VAT
Oslo 39cm Matt Anthracite base unit	1.754	174.00	208.80
Oslo/Faro 39 cast top	51.005	120.00	144.00
Status 390 cast top	51.022	120.00	144.00

Oslo Anthracite WC Unit

Description	Code	£ Ex VAT	£ Inc VAT
Oslo WC unit Matt Anthracite	1.759	228.00	273.60
Oslo WC unit top Matt Anthracite	1.760	41.00	49.20
Oslo WC unit plinth Matt Anthracite	1.761	10.00	12.00

Extras

Description	Code	£ Ex VAT	£ Inc VAT
Trap for external overflow kit	7.0015	16.00	19.20
Flip Top Basin Waste - Unslotted	25.0005	12.00	14.40

*Due to depth of the waste area, the trap for external overflow kit & a flip top basin waste (unslotted) are recommended for installation.

FEATURES

- Soft close system on doors and drawers

FEATURES - CAST MARBLE TOPS

- Made of 75% natural marble stone
- Repairable if chipped
- Seamless surface, easy to maintain

1.064/1.754

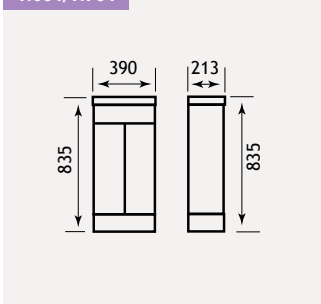

1.294

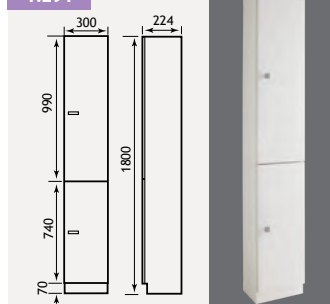

51.005

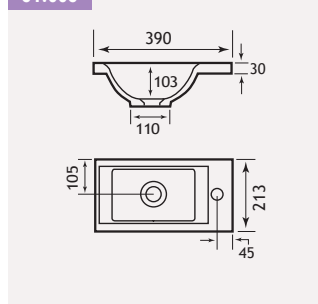

1.287/1.759

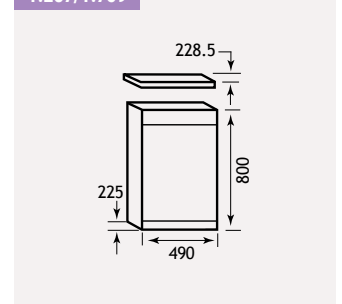

Oslo 39 - Door Unit Range

OSLO 39 DARK WALNUT TWO DOOR MODEL



Oslo creates a stunning impression, a quality carcass with soft close systems on both the doors and drawers. New minimalist stone resin-cast tops allow more depth to the basin than ceramic sinks and are easy to keep clean. Available in various combinations the Oslo range will grace any bathroom.

Oslo 39 Unit Dark Walnut & WC Unit			
Description	Code	£ Ex VAT	£ Inc VAT
Oslo 39cm base unit*	59.0001	230.00	276.00
Biava Mini basin mono c/w clicker waste	56.2052	83.00	99.60
Oslo Tall Cistern Unit	59.0004	202.00	242.40
Oslo Tall Cistern Unit top	59.0005	35.00	42.00

NB Product is vinyl wrapped MDF in dark walnut. *Not compatible with 51.025. For matching bath panels and toilet seats please see page 384-387.

FEATURES

- Soft close system on doors and drawers
- Fluorescent lights on mirrors

FEATURES - CAST MARBLE TOPS

- Made of 75% natural marble stone
- Repairable if chipped
- Seamless surface, easy to maintain

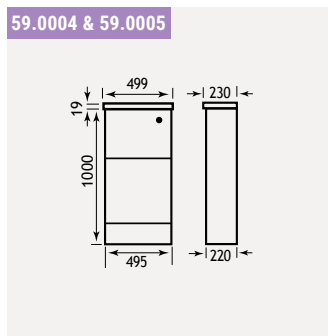
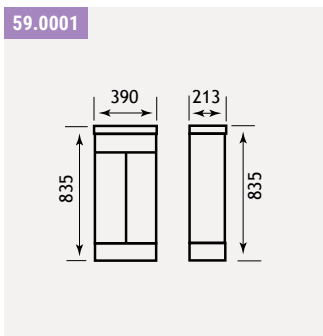

OSLO 39 COMPATIBLE BASINS

Oslo base units create a stunning impression with their simplistic yet sophisticated design. Choosing a basin that matches your selection of tap or accessories unites the all design elements to display an effort look.

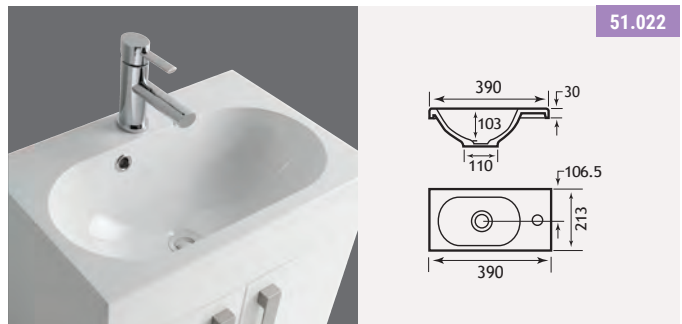

Status 39 Cast Top			
Description	Code	£ Ex VAT	£ Inc VAT
Status 39 cast top*	51.022	120.00	144.00

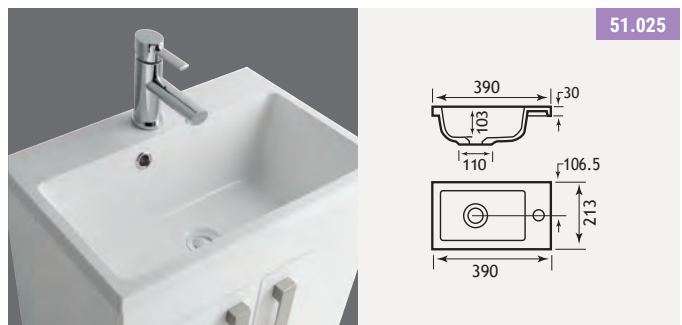

Quantum 39 Cast Top			
Description	Code	£ Ex VAT	£ Inc VAT
Quantum 39 cast top*	51.025	121.00	145.20



Oslo 39 Cast Top			
Description	Code	£ Ex VAT	£ Inc VAT
Oslo 39 cast top*	51.005	120.00	144.00

Extras			
Description	Code	£ Ex VAT	£ Inc VAT
Trap for external overflow kit	7.0015	16.00	19.20
Flip Top Basin Waste - Unslotted	25.0005	12.00	14.40

*7.0015 & unslotted waste recommended for installation

Oslo 44 - Door/Drawer Unit Range



The Oslo 44 model is both stylish and practical. Soft close systems on doors and drawers giving full access to all contents in one smooth action.

The Oslo 44 model is both stylish and practical. Soft close systems on doors and drawers giving full access to all contents in one smooth action.

Oslo 44 White Door Unit

Description	Code	£ Ex VAT	£ Inc VAT
Oslo 44cm door base unit	1.065	202.00	242.40
Contempo handle 128mm	3076	13.00	15.60
Status 440 cast top*	51.023	158.00	189.60

Oslo 44 WC

Description	Code	£ Ex VAT	£ Inc VAT
Oslo WC unit only	1.287	228.00	273.60
Oslo WC unit lid	1.075	41.00	49.20
Oslo WC unit plinth	1.288	10.00	12.00

FEATURES UNIT

- Soft close system on doors and drawers

Oslo 44 White Drawer Unit

Description	Code	£ Ex VAT	£ Inc VAT
Oslo 44cm drawer base unit	1.067	380.00	456.00
Contempo handle 128mm	3076	13.00	15.60
Status 440 cast top	51.023	158.00	189.60
Oslo 30cm tall cupboard, 2 door	1.294	283.00	339.60

Extras

Description	Code	£ Ex VAT	£ Inc VAT
Trap for external overflow kit	7.0015	16.00	19.20
Flip Top Basin Waste - Unslotted	25.0005	12.00	14.40

FEATURES UNIT

- Soft close system on doors and drawers

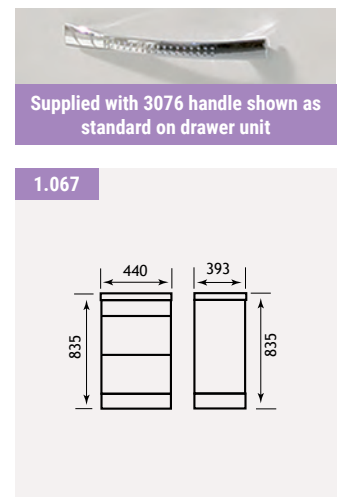
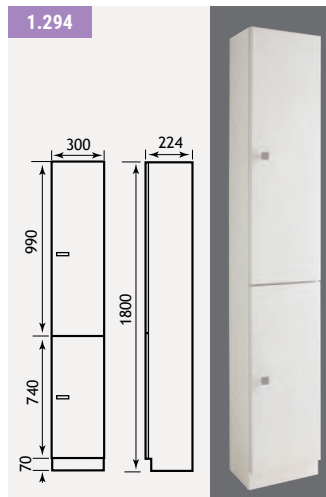
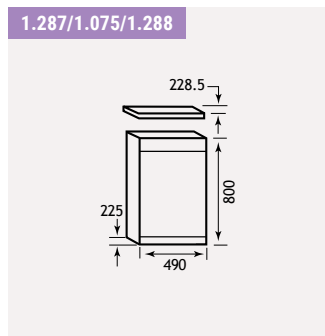
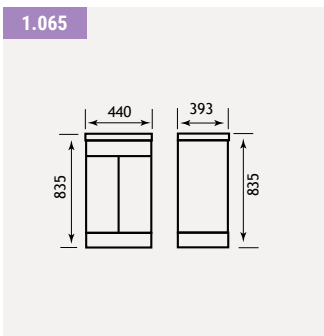

Oslo 44 - Door/Drawer Unit Range



Pictured 1.755 with 51.006 Basin

The Oslo 44 model is both stylish and practical. Soft close systems on doors and drawers giving full access to all contents in one smooth action.

Oslo 44 Anthracite Door Unit			
Description	Code	£ Ex VAT	£ Inc VAT
Oslo 44cm Matt Anthracite door base unit	1.755	203.00	243.60
Contempo handle 128mm	3076	13.00	15.60

FEATURES UNIT

- Soft close system on doors and drawers



Oslo 44 Anthracite Drawer Unit			
Description	Code	£ Ex VAT	£ Inc VAT
Oslo 44cm Matt Anthracite drawer base unit	1.756	380.00	456.00
Contempo handle 128mm	3076	13.00	15.60

Oslo Anthracite WC Unit			
Description	Code	£ Ex VAT	£ Inc VAT
Oslo WC unit Matt Anthracite	1.759	228.00	273.60
Oslo WC unit top Matt Anthracite	1.760	41.00	49.20
Oslo WC unit plinth Matt Anthracite	1.761	10.00	12.00

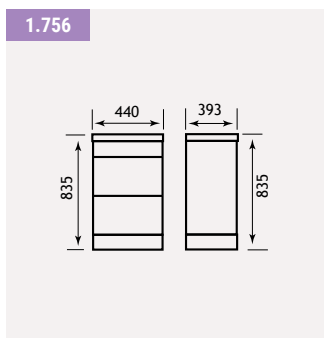
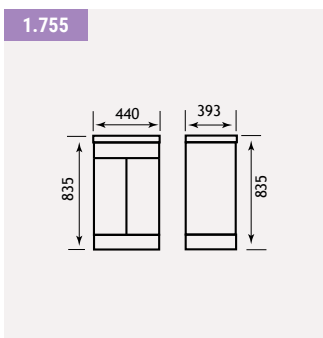

Status 44 Cast Top			
Description	Code	£ Ex VAT	£ Inc VAT
Status 440 cast top*	51.023	158.00	189.60

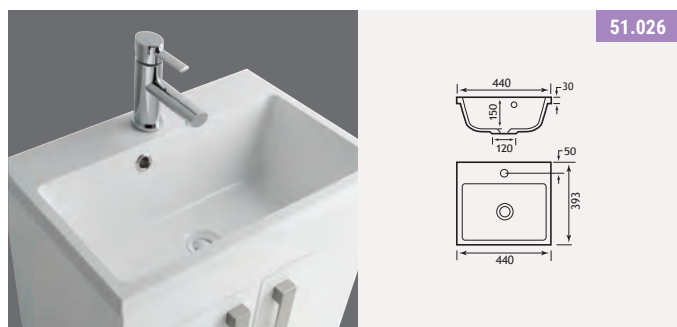

Quantum 44 Cast Top			
Description	Code	£ Ex VAT	£ Inc VAT
Quantum 440 cast top*	51.026	162.00	194.40



Oslo 44 Cast Top			
Description	Code	£ Ex VAT	£ Inc VAT
Oslo 440 cast top*	51.006	139.00	166.80



1.755 Supplied with handles shown as standard on door unit



3076 Contempo handle as optional extra on drawer unit

Extras			
Description	Code	£ Ex VAT	£ Inc VAT
Trap for external overflow kit	7.0015	16.00	19.20
Flip Top Basin Waste - Unslotted	25.0005	12.00	14.40

Oslo 58 - Door/Drawer Unit Range



Oslo creates a stunning impression, a quality carcass with soft close systems on both the doors and drawers. New minimalist stone resin-cast tops allow more depth to the basin than ceramic sinks and are easy to keep clean. Available in various combinations the Oslo range will grace any bathroom.

Oslo 58 White Two Door Unit

Description	Code	£ Ex VAT	£ Inc VAT
Oslo 58cm door base unit	1.068	230.00	276.00
Contempo handle 128mm	3076	13.00	15.60
Status 580 cast top	51.024	176.00	211.20

Oslo White WC Unit

Description	Code	£ Ex VAT	£ Inc VAT
Oslo WC unit only	1.287	228.00	273.60
Oslo WC unit lid	1.075	41.00	49.20
Oslo WC unit plinth	1.288	10.00	12.00

Extras

Description	Code	£ Ex VAT	£ Inc VAT
Trap for external overflow kit	7.0015	16.00	19.20
Flip Top Basin Waste - Unslotted	25.0005	12.00	14.40

FEATURES UNIT

- Soft close system on doors and drawers

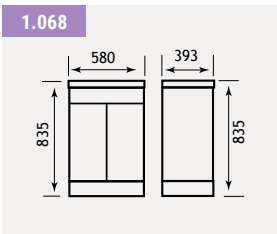
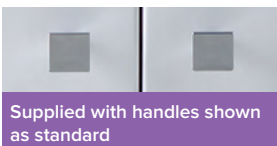

Oslo 58 White Two Drawer Unit

Description	Code	£ Ex VAT	£ Inc VAT
Oslo 58cm drawer base unit	1.069	402.00	482.40
Contempo handle 128mm	3076	13.00	15.60
Status 580 cast top	51.024	176.00	211.20
Oslo 30cm tall cupboard, 2 door	1.294	283.00	339.60

Extras

Description	Code	£ Ex VAT	£ Inc VAT
Trap for external overflow kit	7.0015	16.00	19.20
Flip Top Basin Waste - Unslotted	25.0005	12.00	14.40

FEATURES UNIT

- Soft close system on doors and drawers

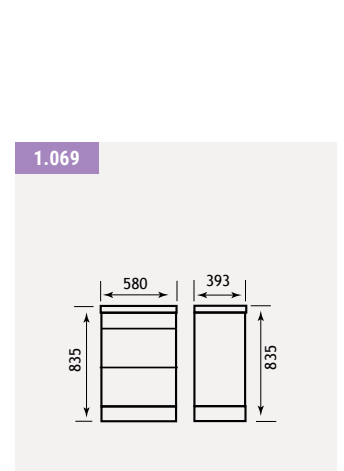
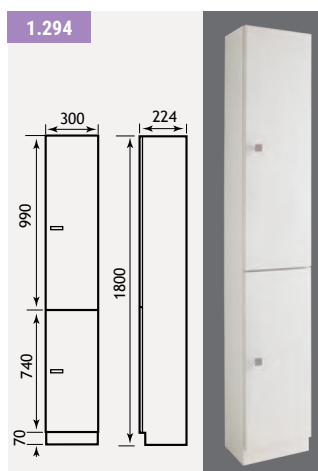
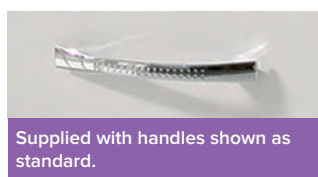

Oslo 58 - Door/Drawer Unit Range



Oslo creates a stunning impression, a quality carcass with soft close systems on both the doors and drawers. New minimalist stone resin-cast tops allow more depth to the basin than ceramic sinks and are easy to keep clean. Available in various combinations the Oslo range will grace any bathroom.

Oslo 58 Anthracite Door Unit

Description	Code	£ Ex VAT	£ Inc VAT
Oslo 58cm Matt Anthracite door base unit	1.757	230.00	276.00
Contempo handle 128mm	3076	13.00	15.60

FEATURES UNIT

- Soft close system on doors and drawers



Oslo 58 Anthracite Drawer Unit

Description	Code	£ Ex VAT	£ Inc VAT
Oslo 58cm Matt Anthracite drawer unit	1.758	402.00	482.40
Contempo handle 128mm	3076	13.00	15.60

Oslo Anthracite WC Unit

Description	Code	£ Ex VAT	£ Inc VAT
Oslo WC unit Matt Anthracite	1.759	228.00	273.60
Oslo WC unit top Matt Anthracite	1.760	41.00	49.20
Oslo WC unit plinth Matt Anthracite	1.761	10.00	12.00

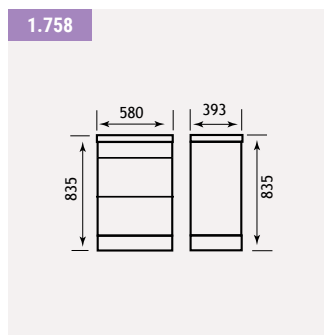
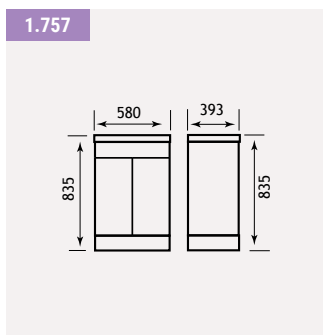

OSLO 58 COMPATIBLE BASINS

Oslo base units create a stunning impression with their simplistic yet sophisticated design. Choosing a basin that matches your selection of tap or accessories unites the all design elements to display an effort look. *7.0015 trap and unslotted basin waste recommended for installation.

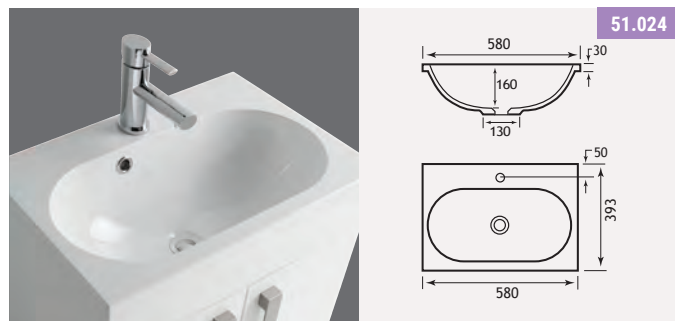

Status 58 Cast Top

Description	Code	£ Ex VAT	£ Inc VAT
Status 580 cast top*	51.024	176.00	211.20

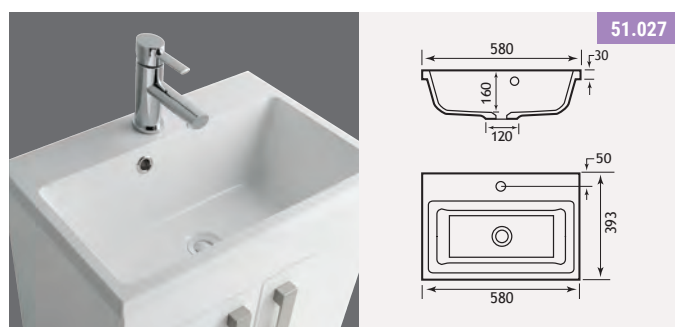

Quantum 58 Cast Top

Description	Code	£ Ex VAT	£ Inc VAT
Quantum 580 cast top*	51.027	185.00	222.00



Oslo 58 Cast Top

Description	Code	£ Ex VAT	£ Inc VAT
Oslo 58 cast top*	51.007	153.00	183.60

FEATURES - CAST MARBLE TOPS

- Made of 75% natural marble stone
- Repairable if chipped
- Seamless surface, easy to maintain



1.757 Supplied with handles shown as standard on door unit



3076 Contempo handle as optional extra on drawer unit and door

Extras

Description	Code	£ Ex VAT	£ Inc VAT
Trap for external overflow kit	7.0015	16.00	19.20
Flip Top Basin Waste - Unslotted	25.0005	12.00	14.40

Oslo 58 - Door/Drawer Unit Range



DOOR MODEL



DRAWER MODEL



Oslo creates a stunning impression, a quality carcass with soft close systems on both the doors and drawers. New minimalist stone resin-cast tops allow more depth to the basin than ceramic sinks and are easy to keep clean. Available in various combinations the Oslo range will grace any bathroom.

Oslo 58 Dark Walnut Two Door Unit			
Description	Code	£ Ex VAT	£ Inc VAT
Oslo 58cm door base unit	59.0002	256.00	307.20
Oslo 580 cast top	51.007	153.00	183.60

Oslo 58 Dark Walnut Two Drawer Unit			
Description	Code	£ Ex VAT	£ Inc VAT
Oslo 58cm drawer base unit	59.0003	319.00	382.80
Status 580 cast top	51.024	176.00	211.20

Oslo 58 Dark Walnut WC Unit			
Description	Code	£ Ex VAT	£ Inc VAT
Oslo Tall Cistern Unit	59.0004	202.00	242.40
Oslo Tall Cistern Unit Top	59.0005	35.00	42.00
Anjou High Level BTW Pan	75.0013	270.00	324.00
Rhone Soft Close Seat	40.0001	57.00	68.40

*Due to depth of the waste area, the trap for external overflow kit & a flip top basin waste (unslotted) are recommended for installation.

NB Product is vinyl wrapped MDF in dark walnut. For matching bath panels and toilet seats please see page 384-387. See page 362 for matching tall cistern in dark walnut.

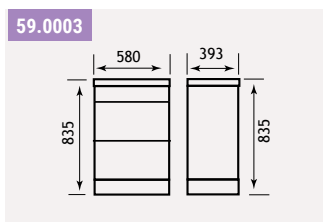
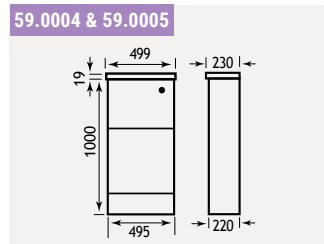
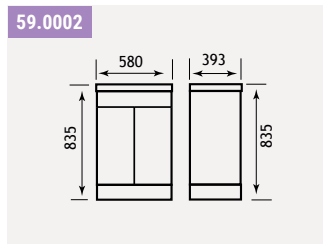

Extras			
Description	Code	£ Ex VAT	£ Inc VAT
Trap for external overflow kit	7.0015	16.00	19.20
Flip Top Basin Waste - Unslotted	25.0005	12.00	14.40

FEATURES - UNIT
 • Soft close system on doors and drawers

Oslo 58 - Door/Drawer Unit Range

OSLO 58 COMPATIBLE BASINS

Oslo base units create a stunning impression with their simplistic yet sophisticated design. Choosing a basin that matches your selection of tap or accessories unites the all design elements to display an effort look. *7.0015 trap and unslotted basin waste recommended for installation.

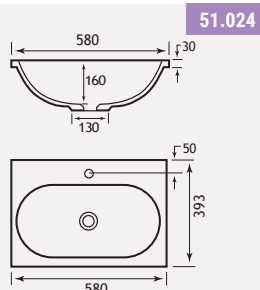

Status 58 Cast Top

Description	Code	£ Ex VAT	£ Inc VAT
Status 580 cast top*	51.024	176.00	211.20

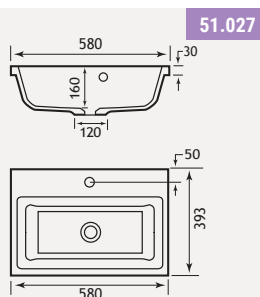

Quantum 58 Cast Top

Description	Code	£ Ex VAT	£ Inc VAT
Quantum 580 cast top**	51.027	185.00	222.00

**Quantum 51.027 is not compatible with Walnut door or drawer unit 59.0002 & 59.0003

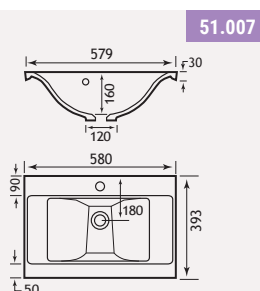

Oslo 58 Cast Top

Description	Code	£ Ex VAT	£ Inc VAT
Oslo 58 cast top*	51.007	153.00	183.60

FEATURES - CAST MARBLE TOPS

- Made of 75% natural marble stone
- Repairable if chipped
- Seamless surface, easy to maintain

Status Top - 51.024



STATUS BATH RANGE Complete the LOOK

Just like the Status basin top, the Status Baths bring a unique perspective to bathroom design the and adds a touch of luxury with its soft curves.



Flip to the Bath section to find your ideal Status bath size:
 Status showerbath 1550 x 850 (P101), 1600 x 725 (P57), 1700 x 785 (P69),
 1700 x 800 (P83)

Oslo 80 - Drawer Unit Range

OSLO 80 TWO DRAWER MODEL



The two drawer Oslo model is both stylish and practical. The drawers glide open and shut on soft close systems giving full access to all contents in one smooth action.

Oslo 80 Base And Top

Description	Code	£ Ex VAT	£ Inc VAT
Oslo 800mm drawer base unit	1.076	437.00	524.40
Oslo 80 cast top*	51.008	195.00	234.00
Leven 800 x 600 bluetooth mirror	56.1083	312.00	374.40
Sorrento 70cm mirror †	1.419	118.00	141.60
Sorrento 80cm cornice **	1.522	185.00	222.00
Sorrento 800mm 'Wave' action infra red cornice **	1.219	234.00	280.80

Oslo WC Unit

Description	Code	£ Ex VAT	£ Inc VAT
Oslo WC unit only	1.287	228.00	273.60
Oslo WC unit lid	1.075	41.00	49.20
Oslo WC unit plinth	1.288	10.00	12.00

Extras

Description	Code	£ Ex VAT	£ Inc VAT
Trap for external overflow kit	7.0015	16.00	19.20
Flip Top Basin Waste - Unslotted	25.0005	12.00	14.40

FEATURES

- Soft close system on drawers

FEATURES - CAST MARBLE TOPS

- Made of 75% natural marble stone
- Repairable if chipped
- Seamless surface, easy to maintain

† Mirror must be fitted with a cornice. *Due to depth of the waste area, the trap for external overflow kit & a flip top basin waste (unslotted) are recommended for installation. **During the life of this brochure the lights may change to LED.



Also compatible with the Oslo 80 is the Sorrento mirror and cornice as shown above. For wall mirrors and cabinets see pages 390-413.

1.076

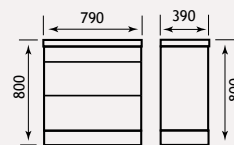

Sorrento cornices are now available with an option of 'Wave' action infra-red technology to activate lights.

51.008

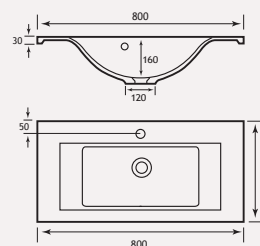

Oslo 100 - Drawer Unit Range

OSLO 100 SINGLE BOWL TWO DRAWER MODEL



The two drawer Oslo model is both stylish and practical. The drawers glide open giving full access to all contents in one smooth action.

Oslo 100 Base and Single Bowl Top

Description	Code	£ Ex VAT	£ Inc VAT
Oslo 1000mm drawer base unit for single bowl	1.081	468.00	561.60
Oslo 100 cast top*	51.009	221.00	265.20
Plain Mirror 555 x 1000	40.0020	66.00	79.20

Oslo WC Unit

Description	Code	£ Ex VAT	£ Inc VAT
Oslo WC unit only	1.287	228.00	273.60
Oslo WC unit lid	1.075	41.00	49.20
Oslo WC unit plinth	1.288	10.00	12.00

Extras

Description	Code	£ Ex VAT	£ Inc VAT
Trap for external overflow kit	7.0015	16.00	19.20
Flip Top Basin Waste - Unslotted	25.0005	12.00	14.40

FEATURES

- Soft close system on drawers
- FEATURES - CAST MARBLE TOPS**
- Made of 75% natural marble stone
- Repairable if chipped
- Seamless surface, easy to maintain

*Due to depth of the waste area, the trap for external overflow kit & a flip top basin waste (unslotted) are recommended for installation.

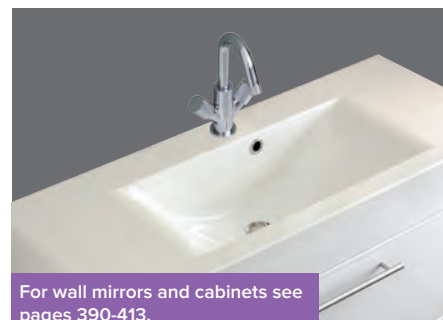
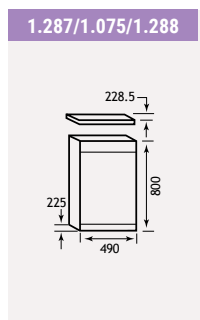
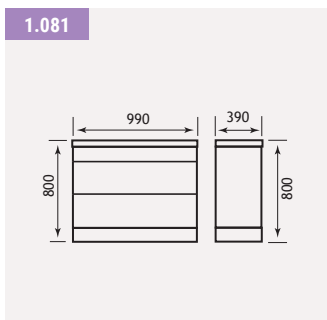
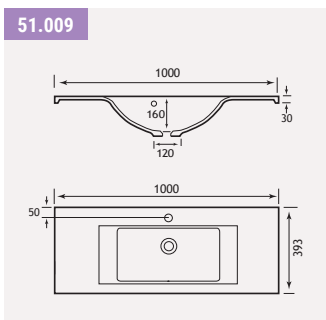

For wall mirrors and cabinets see pages 390-413.

Oslo 100 - Drawer Unit Range

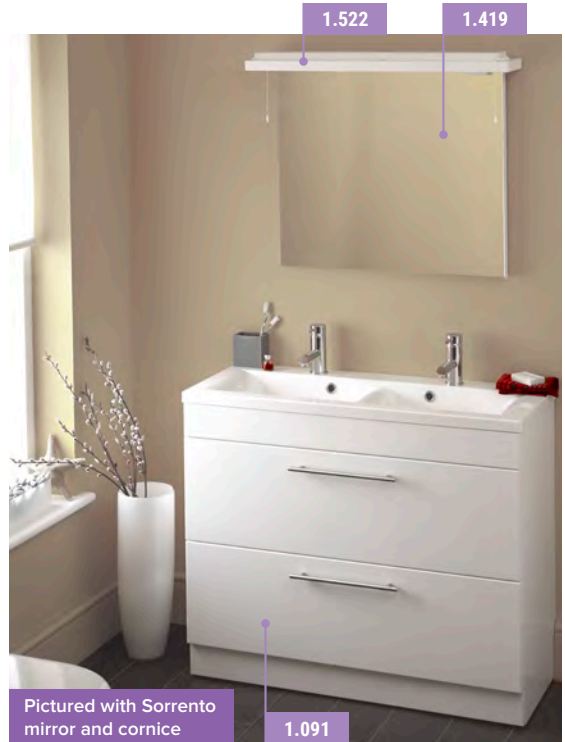

The two drawer Oslo model is both stylish and practical. The drawers glide open giving full access to all contents in one smooth action. Also compatible with the Oslo 100 is the Sorrento mirror and cornice as shown left. For wall mirrors and cabinets see pages 387-401. The internal design of these drawers may change during the lifetime of this brochure.

Oslo 100 Base And Single And Double Bowl Top

Description	Code	£ Ex VAT	£ Inc VAT
Oslo 1000mm drawer base unit for double bowl	1.091	468.00	561.60
Oslo 100 double cast top*	51.010	250.00	300.00
Sorrento 70cm mirror †	1.419	118.00	141.60
Sorrento 80cm cornice **	1.522	185.00	222.00
Sorrento 800mm 'Wave' action infra red cornice **	1.219	234.00	280.80
Plain Mirror 555 x 1000	40.0020	66.00	79.20

Oslo WC Unit

Description	Code	£ Ex VAT	£ Inc VAT
Oslo WC unit only	1.287	228.00	273.60
Oslo WC unit lid	1.075	41.00	49.20
Oslo WC unit plinth	1.288	10.00	12.00

Extras

Description	Code	£ Ex VAT	£ Inc VAT
Trap for external overflow kit *	7.0015	16.00	19.20
Flip Top Basin Waste - Unslotted	25.0005	12.00	14.40

*2 x 7.0015 required for item 1.091 bowl.

FEATURES - CAST MARBLE TOPS

- Made of 75% natural marble stone
- Repairable if chipped
- Seamless surface, easy to maintain

† Mirror must be fitted with a cornice. *Due to depth of the waste area, the trap for external overflow kit & a flip top basin waste (unslotted) are recommended for installation. **During the life of this brochure the lights may change to LED.

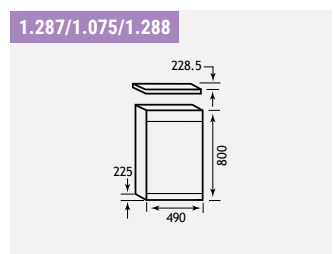
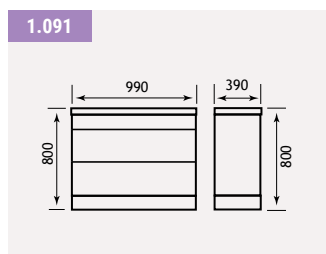
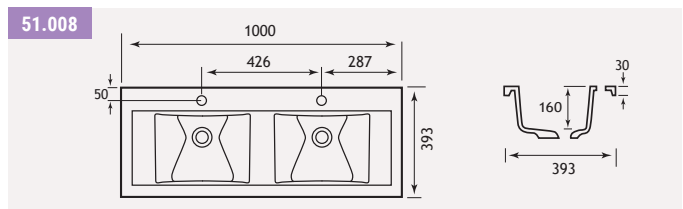
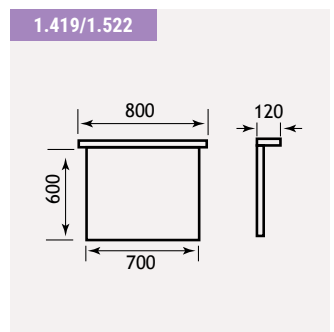
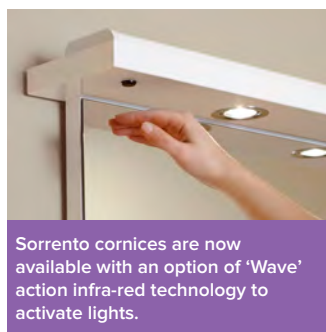

Oslo Corner WC & Cupboards



These versatile, modular wall cupboards are ideal for family needs giving everyone their own storage space. The cupboards are reversible, feature soft close doors and can be used in any combination.

Oslo Corner WC			
Description	Code	£ Ex VAT	£ Inc VAT
Oslo WC unit only *	1.287	228.00	273.60
Oslo corner unit lid	1.267	79.00	94.80
Oslo WC unit plinth	1.288	10.00	12.00
Oslo square 400mm wall cupboard	1.263	139.00	166.80
Oslo square 400mm mirror wall cupboard	1.264	146.00	175.20
Oslo wall cupboard 400 x 800mm	1.265	177.00	212.40
Oslo wall cupboard 400 x 1000mm	1.266	192.00	230.40
Vantage Plain Hidden Cistern CP Push Button	17.001	133.00	159.60
Eastbrook Jacket Hidden Cistern - Bottom Inlet	53.001	82.00	98.40
Vantage Hidden Cistern with Jacket	17.3029	155.00	186.00
Oslo 30cm tall cupboard, 2 door	1.294	283.00	339.60

*NB Price does not include BTW pan or seat. Hidden cistern, corner unit lid and plinth sold separately.

Oslo Extras			
Description	Code	£ Ex VAT	£ Inc VAT
Upper panel for 1.287 Oslo WC unit	1.99070	65.00	78.00
Lower panel Oslo 50cm tall cistern unit	1.99046	59.00	70.80
Oslo corner unit lid *	1.267	79.00	94.80
Oslo WC unit lid	1.075	41.00	49.20

FEATURES

- Soft close system on doors
- Wall cupboards are reversible
- Modular versatile system

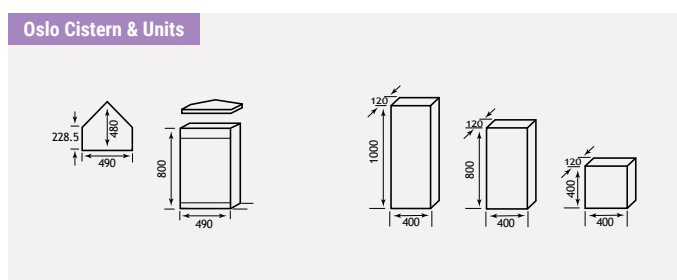

Oslo 44 - Internal Drawer / Push Drawer

OSLO 44 INTERNAL DRAWER



Compatible 440 Basin Tops on page 345 >>

Oslo unit featuring a hidden internal drawer to maximise storage. For compatible basins, please see opposite page.

FEATURES - UNIT

- Soft close system on drawers

1.767

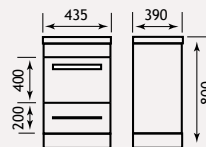

Oslo 44 Internal Drawer

Description	Code	£ Ex VAT	£ Inc VAT
Oslo 44 Unit with Internal Drawer	1.767	405.00	486.00

OSLO 44 WALL HUNG INTERNAL DRAWER



Compatible 440 Basin Tops on page 345 >>

Oslo unit featuring a hidden internal drawer to maximise storage. For compatible basins, please see opposite page.

FEATURES - UNIT

- Soft close system on drawers

1.801

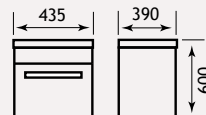

Oslo 44 Wall Hung Internal Drawer

Description	Code	£ Ex VAT	£ Inc VAT
Oslo 44 Wall Hung Unit with Internal Drawer	1.801	326.00	391.20

OSLO 44 PUSH DRAWER



Compatible 440 Basin Tops on page 345 >>

Oslo Unit featuring a double push drawer mechanism for a sleek and contemporary look.

FEATURES - UNIT

- Soft close system on drawers

1.805

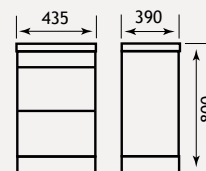

Oslo 44 Push Drawer

Description	Code	£ Ex VAT	£ Inc VAT
Oslo 44 Push Drawer Unit	1.805	312.00	374.40

Oslo 44 - Internal Drawer / Push Drawer

OSLO 44 WALL HUNG PUSH DRAWER



Double Push Drawer Mechanism x 2

Compatible 440 Basin Tops on page 345 >>

Oslo Unit featuring a double push drawer mechanism for a sleek and contemporary look.

FEATURES - UNIT

- Soft close system on drawers

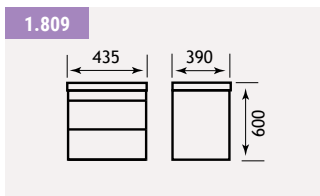

Oslo 44 Wall Hung Push Drawer			
Description	Code	£ Ex VAT	£ Inc VAT
Oslo 44 Wall Hung Push Draw Unit	1.809	294.00	352.80

Complete the LOOK

HELSTON BASIN MONOS

93.0010



Description	Code	£ Ex VAT	£ Inc VAT
Helston Basin Mono (inc waste) Chrome	93.0010	80.00	96.00

For additional colour options, see pages 694-697.

OSLO WC UNIT

1.287/1.075/1.288



Description	Code	£ Ex VAT	£ Inc VAT
Oslo WC unit only	1.287	228.00	273.60
Oslo WC unit lid	1.075	41.00	49.20
Oslo WC unit plinth	1.288	10.00	12.00

OSLO 44 COMPATIBLE BASINS

Oslo base units create a stunning impression with their simplistic yet sophisticated design. Choosing a basin that matches your selection of tap or accessories unites all design elements to display an effort look. *7.0015 trap and unslotted basin waste recommended for installation.



51.023

Status 44 Cast Top

Description	Code	£ Ex VAT	£ Inc VAT
Status 440 cast top*	51.023	158.00	189.60



51.026

Quantum 44 Cast Top

Description	Code	£ Ex VAT	£ Inc VAT
Quantum 440 cast top*	51.026	162.00	194.40



51.006

Oslo 44 Cast Top

Description	Code	£ Ex VAT	£ Inc VAT
Oslo 440 cast top*	51.006	139.00	166.80

- ### FEATURES - CAST MARBLE TOPS
- Made of 75% natural marble stone
 - Repairable if chipped
 - Seamless surface, easy to maintain

Extras

Description	Code	£ Ex VAT	£ Inc VAT
Trap for external overflow kit	7.0015	16.00	19.20
Flip Top Basin Waste - Unslotted	25.0005	12.00	14.40

*7.0015 trap and unslotted basin waste recommended for installation.

Oslo 58 - Internal Drawer / Push Drawer

OSLO 58 INTERNAL DRAWER



Compatible 580 Basin Tops on page 347 >>

Oslo unit featuring a hidden internal drawer to maximise storage. For compatible basins, please see opposite page.

FEATURES - UNIT

- Soft close system on drawers

1.768

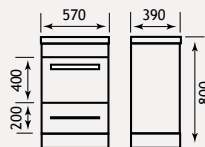

Oslo 58 Internal Drawer

Description	Code	£ Ex VAT	£ Inc VAT
Oslo 58 Unit with Internal Drawer	1.768	444.00	532.80

OSLO 58 WALL HUNG INTERNAL DRAWER



Compatible 580 Basin Tops on page 347 >>

Oslo unit featuring a hidden internal drawer to maximise storage. For compatible basins, please see opposite page.

FEATURES - UNIT

- Soft close system on drawers

1.802

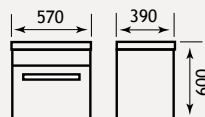

Oslo 58 Wall Hung Internal Drawer

Description	Code	£ Ex VAT	£ Inc VAT
Oslo 58 Wall Hung Unit with Internal Drawer	1.802	362.00	434.40

OSLO 58 PUSH DRAWER



Compatible 580 Basin Tops on page 347 >>

Double Push
Drawer
Mechanism
x 2

Oslo Unit featuring a double push drawer mechanism for a sleek and contemporary look.

FEATURES - UNIT

- Soft close system on drawers

1.806

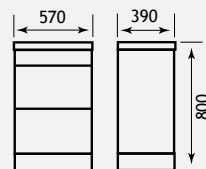

Oslo 58 Push Drawer

Description	Code	£ Ex VAT	£ Inc VAT
Oslo 58 Push Drawer Unit	1.806	336.00	403.20

Oslo 58 - Internal Drawer / Push Drawer

OSLO 58 WALL HUNG PUSH DRAWER



Oslo Unit featuring a double push drawer mechanism for a sleek and contemporary look.

FEATURES - UNIT

- Soft close system on drawers

1.810

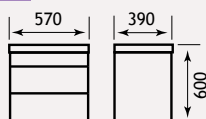

Oslo 58 Wall Hung Push Drawer

Description	Code	£ Ex VAT	£ Inc VAT
Oslo 58 Wall Hung Push Draw Unit	1.810	315.00	378.00

Complete the LOOK

HELSTON BASIN MONOS



93.0010

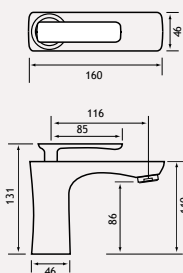

Description	Code	£ Ex VAT	£ Inc VAT
Helston Basin Mono (inc waste) Chrome	93.0010	80.00	96.00

For additional colour options, see pages 694-697.

OSLO WC UNIT



1.287/1.075/1.288

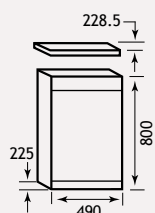

Description	Code	£ Ex VAT	£ Inc VAT
Oslo WC unit only	1.287	228.00	273.60
Oslo WC unit lid	1.075	41.00	49.20
Oslo WC unit plinth	1.288	10.00	12.00

OSLO 58 COMPATIBLE BASINS

Oslo base units create a stunning impression with their simplistic yet sophisticated design. Choosing a basin that matches your selection of tap or accessories unites the all design elements to display an effort look. *7.0015 trap and unslotted basin waste recommended for installation.



51.024

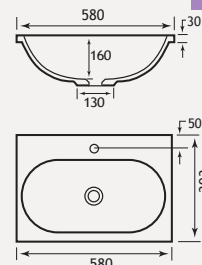

Status 58 Cast Top

Description	Code	£ Ex VAT	£ Inc VAT
Status 580 cast top*	51.024	176.00	211.20



51.027

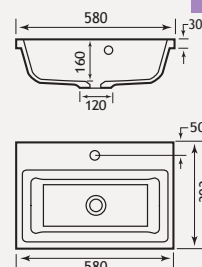

Quantum 58 Cast Top

Description	Code	£ Ex VAT	£ Inc VAT
Quantum 580 cast top*	51.027	185.00	222.00



51.007

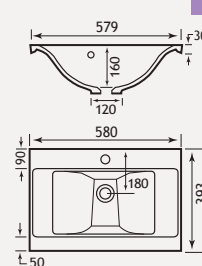

Oslo 58 Cast Top

Description	Code	£ Ex VAT	£ Inc VAT
Oslo 58 cast top*	51.007	153.00	183.60

FEATURES - CAST MARBLE TOPS

- Made of 75% natural marble stone
- Repairable if chipped
- Seamless surface, easy to maintain

Extras

Description	Code	£ Ex VAT	£ Inc VAT
Trap for external overflow kit	7.0015	16.00	19.20
Flip Top Basin Waste - Unslotted	25.0005	12.00	14.40

*7.0015 trap and unslotted basin waste recommended for installation.

Oslo 80 - Internal Drawer / Push Drawer

OSLO 80 INTERNAL DRAWER



Oslo unit featuring a hidden internal drawer to maximise storage. For compatible basins, please see opposite page.

FEATURES - UNIT

- Soft close system on drawers

1.769

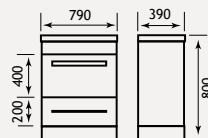

Oslo 80 Internal Drawer

Description	Code	£ Ex VAT	£ Inc VAT
Oslo 80 Unit with Internal Drawer	1.769	497.00	596.40
Oslo 80 cast top	51.008	195.00	234.00

OSLO 80 WALL HUNG INTERNAL DRAWER



Oslo unit featuring a hidden internal drawer to maximise storage. For compatible basins, please see opposite page.

FEATURES - UNIT

- Soft close system on drawers

1.803

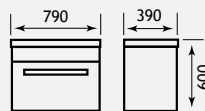

Oslo 80 Wall Hung Internal Drawer

Description	Code	£ Ex VAT	£ Inc VAT
Oslo 80 Wall Hung Unit with Internal Drawer	1.803	415.00	498.00
Oslo 80 cast top	51.008	195.00	234.00

OSLO 80 PUSH DRAWER



Double Push
Drawer
Mechanism
x 2

Oslo Unit featuring a double push drawer mechanism for a sleek and contemporary look.

FEATURES - UNIT

- Soft close system on drawers

1.807

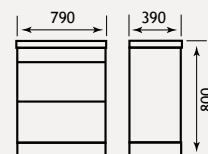

Oslo 80 Push Drawer

Description	Code	£ Ex VAT	£ Inc VAT
Oslo 80 Push Drawer Unit	1.807	379.00	454.80
Oslo 80 cast top	51.008	195.00	234.00

Oslo 80 - Internal Drawer / Push Drawer



Oslo Unit featuring a double push drawer mechanism for a sleek and contemporary look.

FEATURES - UNIT

- Soft close system on drawers

1.811

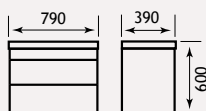

Oslo 80 Wall Hung Push Drawer

Description	Code	£ Ex VAT	£ Inc VAT
Oslo 80 Wall Hung Push Draw Unit	1.811	340.00	408.00

Complete the LOOK

HELSTON BASIN MONOS



93.0010

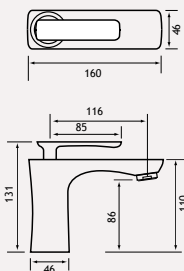

Description	Code	£ Ex VAT	£ Inc VAT
Helston Basin Mono (inc waste) Chrome	93.0010	80.00	96.00

For additional colour options, see pages 694-697.

OSLO WC UNIT



1.287/1.075/1.288

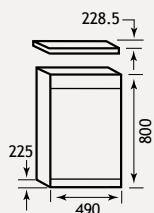

Description	Code	£ Ex VAT	£ Inc VAT
Oslo WC unit only	1.287	228.00	273.60
Oslo WC unit lid	1.075	41.00	49.20
Oslo WC unit plinth	1.288	10.00	12.00

OSLO 80 BASIN

Oslo base units create a stunning impression with their simplistic yet sophisticated design. Choosing a basin that matches your selection of tap or accessories unites the all design elements to display an effort look. *7.0015 trap and unslotted basin waste recommended for installation.



51.008

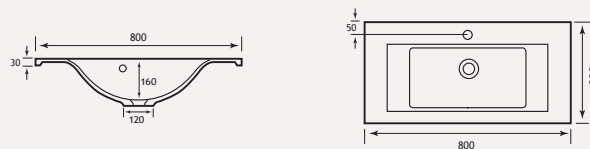

Oslo 80 Cast Top

Description	Code	£ Ex VAT	£ Inc VAT
Oslo 80 cast top	51.008	195.00	234.00

FEATURES - CAST MARBLE TOPS

- Made of 75% natural marble stone
- Repairable if chipped
- Seamless surface, easy to maintain

Extras

Description	Code	£ Ex VAT	£ Inc VAT
Trap for external overflow kit	7.0015	16.00	19.20
Flip Top Basin Waste - Unslotted	25.0005	12.00	14.40

*7.0015 trap and unslotted basin waste recommended for installation.

Oslo 100 - Internal Drawer / Push Drawer

OSLO 100 INTERNAL DRAWER



Oslo unit featuring a hidden internal drawer to maximise storage. For compatible basins, please see opposite page.

FEATURES - UNIT

- Soft close system on drawers

1.770

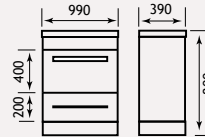

Oslo 100 Internal Drawer

Description	Code	£ Ex VAT	£ Inc VAT
Oslo 100 Unit with Internal Drawer	1.770	547.00	656.40
Oslo 100 cast top	51.009	221.00	265.20

OSLO 100 WALL HUNG INTERNAL DRAWER



Oslo unit featuring a hidden internal drawer to maximise storage. For compatible basins, please see opposite page.

FEATURES - UNIT

- Soft close system on drawers

1.804

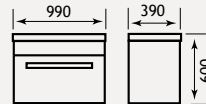

Oslo 100 Wall Hung Internal Drawer

Description	Code	£ Ex VAT	£ Inc VAT
Oslo 100 Wall Hung Unit with Internal Drawer	1.804	462.00	554.40
Oslo 100 cast top	51.009	221.00	265.20

OSLO 100 PUSH DRAWER



Double Push
Drawer
Mechanism
x 2

Oslo Unit featuring a double push drawer mechanism for a sleek and contemporary look.

FEATURES - UNIT

- Soft close system on drawers

1.808

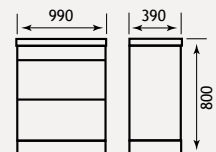

Oslo 100 Push Drawer

Description	Code	£ Ex VAT	£ Inc VAT
Oslo 100 Push Drawer Unit	1.808	411.00	493.20
Oslo 100 cast top	51.009	221.00	265.20

Oslo 100 - Internal Drawer / Push Drawer

OSLO 100 WALL HUNG PUSH DRAWER



Oslo Unit featuring a double push drawer mechanism for a sleek and contemporary look.

1.812

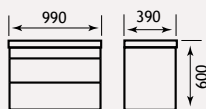

FEATURES - UNIT

- Soft close system on drawers

Oslo 100 Wall Hung Push Drawer

Description	Code	£ Ex VAT	£ Inc VAT
Oslo 100 Wall Hung Push Draw Unit	1.812	365.00	438.00

Complete the LOOK

HELSTON BASIN MONOS



93.0010

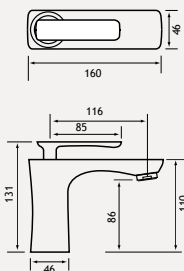

Description	Code	£ Ex VAT	£ Inc VAT
Helston Basin Mono (inc waste) Chrome	93.0010	80.00	96.00

For additional colour options, see pages 694-697.

OSLO WC UNIT



1.287/1.075/1.288

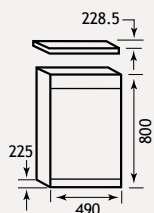

Description	Code	£ Ex VAT	£ Inc VAT
Oslo WC unit only	1.287	228.00	273.60
Oslo WC unit lid	1.075	41.00	49.20
Oslo WC unit plinth	1.288	10.00	12.00

OSLO 100 BASIN

Oslo base units create a stunning impression with their simplistic yet sophisticated design. Choosing a basin that matches your selection of tap or accessories unites the all design elements to display an effort look. *7.0015 trap and unslotted basin waste recommended for installation.



51.009

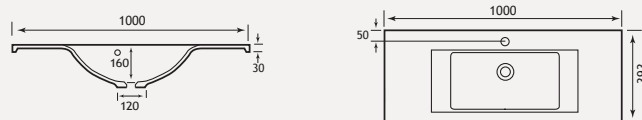

Oslo 100 Cast Top

Description	Code	£ Ex VAT	£ Inc VAT
Oslo 100 cast top	51.009	221.00	265.20

Extras

Description	Code	£ Ex VAT	£ Inc VAT
Trap for external overflow kit	7.0015	16.00	19.20
Flip Top Basin Waste - Unslotted	25.0005	12.00	14.40

*7.0015 trap and unslotted basin waste recommended for installation.

Oslo Max Range

OSLO MAX CORNER BASE UNITS



Oslo Max			
Description	Code	£ Ex VAT	£ Inc VAT
Oslo Max Corner Base Unit LH	1.301	348.00	417.60
Oslo Max Corner Base Unit RH	1.302	348.00	417.60
Oslo Max cistern unit	1.303	230.00	276.00
Oslo Max Long top LH *	51.039	256.00	307.20
Oslo Max Long top RH *	51.040	256.00	307.20
Oslo Max Single top LH *	51.041	180.00	216.00
Oslo Max Single top RH *	51.042	180.00	216.00
Bonito Slab top 600 for WC unit	51.021	89.00	106.80

Plinth included. *Due to depth of the waste area, the trap for external overflow kit & a flip top basin waste (unslotted) are recommended for installation.

Extras			
Description	Code	£ Ex VAT	£ Inc VAT
Trap for external overflow kit	7.0015	16.00	19.20
Flip Top Basin Waste - Unslotted	25.0005	12.00	14.40

*7.0015 trap and unslotted basin waste recommended for installation.

FEATURES

- Soft close system on doors

FEATURES - CAST MARBLE TOPS

- Made of 75% natural marble stone
- Repairable if chipped
- Seamless surface, easy to maintain

BTW Pan Extras			
Description	Code	£ Ex VAT	£ Inc VAT
Vantage Plain Hidden Cistern CP Push Button	17.001	133.00	159.60
Vantage Hidden Cistern with Jacket	17.3029	155.00	186.00
Eastbrook Jacket Hidden Cistern - Bottom Inlet	53.001	82.00	98.40
Flexible WC Connector for BTW Pans †	2.009	29.00	34.80

†Pan connector 2.009 is recommended for use with our BTW pans.

51.041 (Left hand shown)

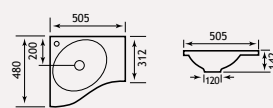

51.040 (Right hand shown)

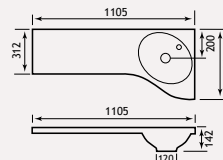

1.301

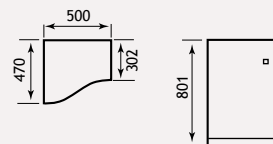

1.303

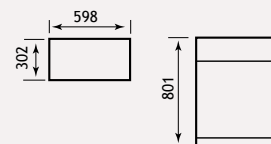

Oslo Combination Range

OSLO COMBINATION UNIT



29.0018

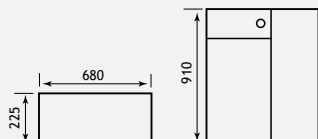

A quirky all-in-one unit with WC and basin combined to maximise restricted space.

Oslo Combination

Description	Code	£ Ex VAT	£ Inc VAT
Oslo Combination Unit LH	29.0118	186.00	223.20
Oslo Combination Unit RH	29.0128	186.00	223.20
Duo Compact Cistern	7.0002	62.00	74.40

NB. Pan, seat, cistern, basin and tap all sold separately, but plain top is included.

Compatible Basins

Description	Code	£ Ex VAT	£ Inc VAT
Oslo/Faro 39 cast top *	51.005	120.00	144.00
Status 390 cast top *	51.022	120.00	144.00
Flip Top Basin Waste - Unslotted	25.0005	12.00	14.40

*Due to depth of the waste area, the trap for external overflow kit & a flip top basin waste (unslotted) are recommended for installation.

Extras

Description	Code	£ Ex VAT	£ Inc VAT
Trap for external overflow kit	7.0015	16.00	19.20
Flip Top Basin Waste - Unslotted	25.0005	12.00	14.40

FEATURES - CAST MARBLE TOPS

- Made of 75% natural marble stone
- Repairable if chipped
- Seamless surface, easy to maintain



Right hand shown

Oslo Combi Range

OSLO CORNER COMBI

VARIANT - A

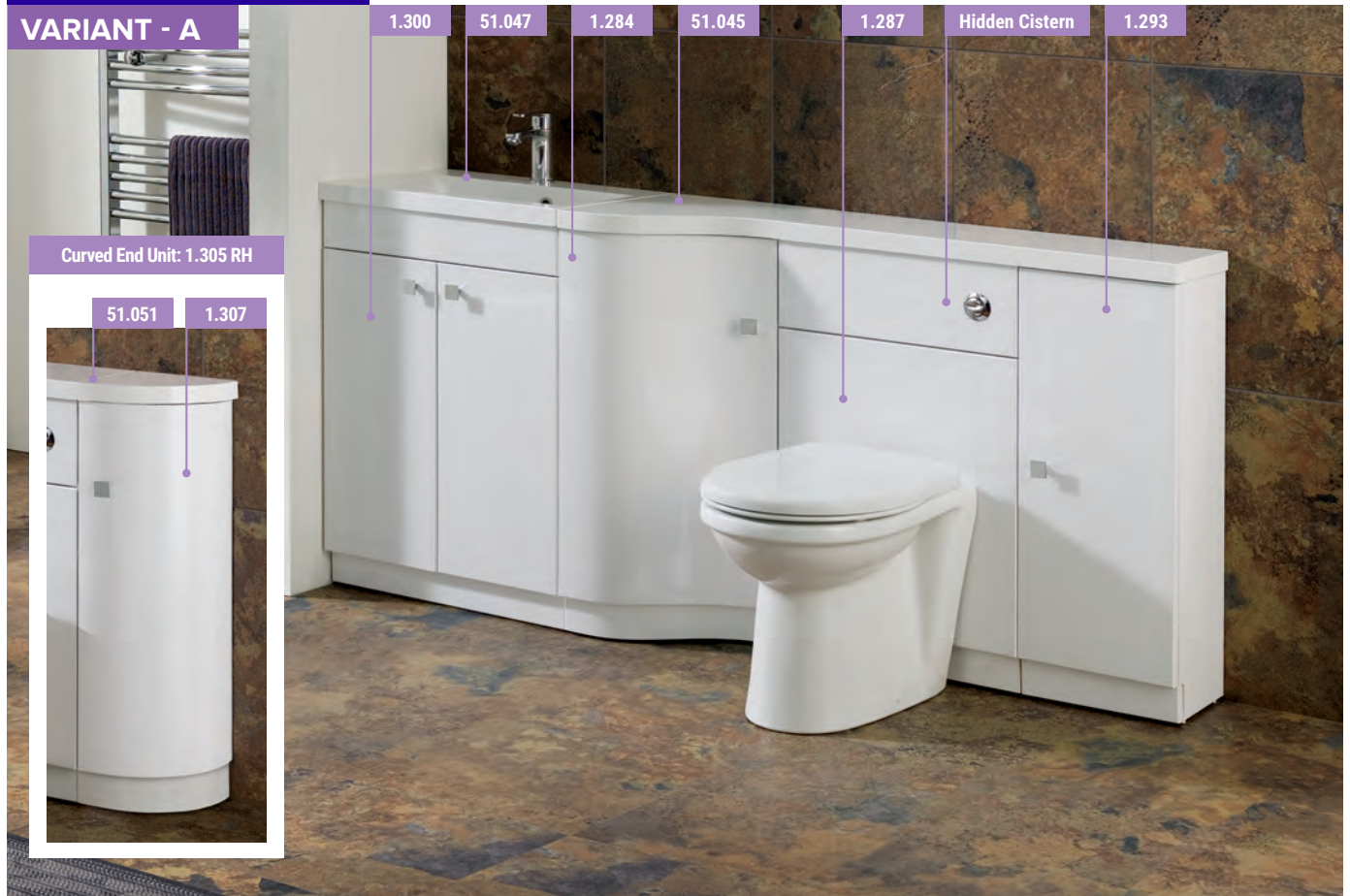

VARIANT - B



Oslo Combi Range

The Oslo Corner Combi collection is a clean, space efficient range that maximises storage. Choose from a selection of longer or shorter length set-ups to suit your taste and bathroom size.

Oslo Corner Combi

Description	Code	£ Ex VAT	£ Inc VAT
Oslo Combi 580 door base unit	1.300	219.00	262.80
Oslo 580 Combi basin top	51.047	132.00	158.40

*Due to depth of the waste area, the trap for external overflow kit & a flip top basin waste (unslotted) are recommended for installation.

Oslo Cabinets

Description	Code	£ Ex VAT	£ Inc VAT
Oslo Corner base unit LH	1.284	300.00	360.00
Oslo Corner base unit RH	1.285	300.00	360.00
Oslo 30cm base cupboard, 1 door	1.293	117.00	140.40
Oslo curved end unit LH	1.306	199.00	238.80
Oslo curved end unit RH	1.307	199.00	238.80

Oslo WC Unit

Description	Code	£ Ex VAT	£ Inc VAT
Oslo WC unit only	1.287	228.00	273.60
Oslo WC unit plinth	1.288	10.00	12.00
Plain infill panel 30 x 81cm	1.042	60.00	72.00

For hidden cisterns see pages 246-247.

Plain Tops

Description	Code	£ Ex VAT	£ Inc VAT
Oslo Curved Long top Plain LH	51.043	112.00	134.40
Oslo Curved Long top Plain RH	51.044	112.00	134.40
Oslo Curved Single top Plain LH	51.045	79.00	94.80
Oslo Curved Single top Plain RH	51.046	79.00	94.80
Oslo Slab top 794	51.048	195.00	234.00
Oslo single quad top	51.051	66.00	79.20

Extras

Description	Code	£ Ex VAT	£ Inc VAT
Trap for external overflow kit	7.0015	16.00	19.20
Flip Top Basin Waste - Unslotted	25.0005	12.00	14.40

FEATURES

- Soft close system on doors and drawers

FEATURES - CAST MARBLE TOPS

- Made of 75% natural marble stone
- Repairable if chipped
- Seamless surface, easy to maintain

51.051

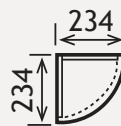

51.045

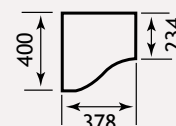

1.075

1.287

1.288

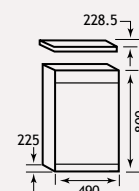

51.046

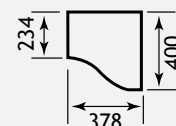

51.047

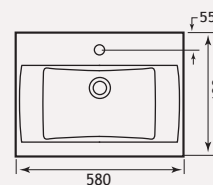
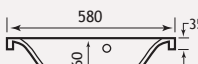

1.284/51.045

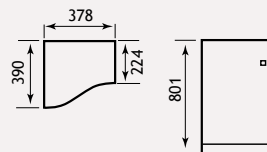

1.285/51.046

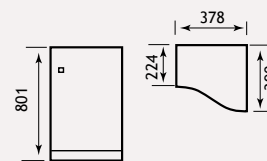

1.300

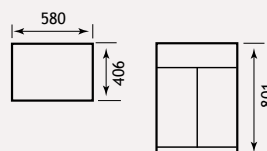

1.293

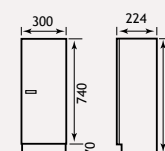

VARIANT - C

51.047

51.045



1.300

1.284

51.048

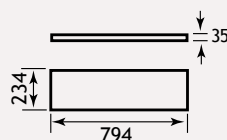

51.043

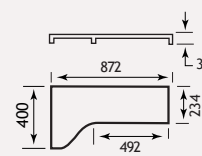

1.306/51.049

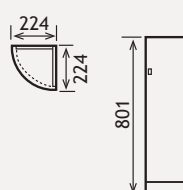

1.307/51.044/51.050

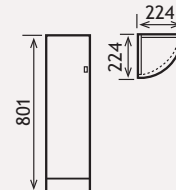

Oslo Combi Range

OSLO CORNER COMBI

VARIANT - D

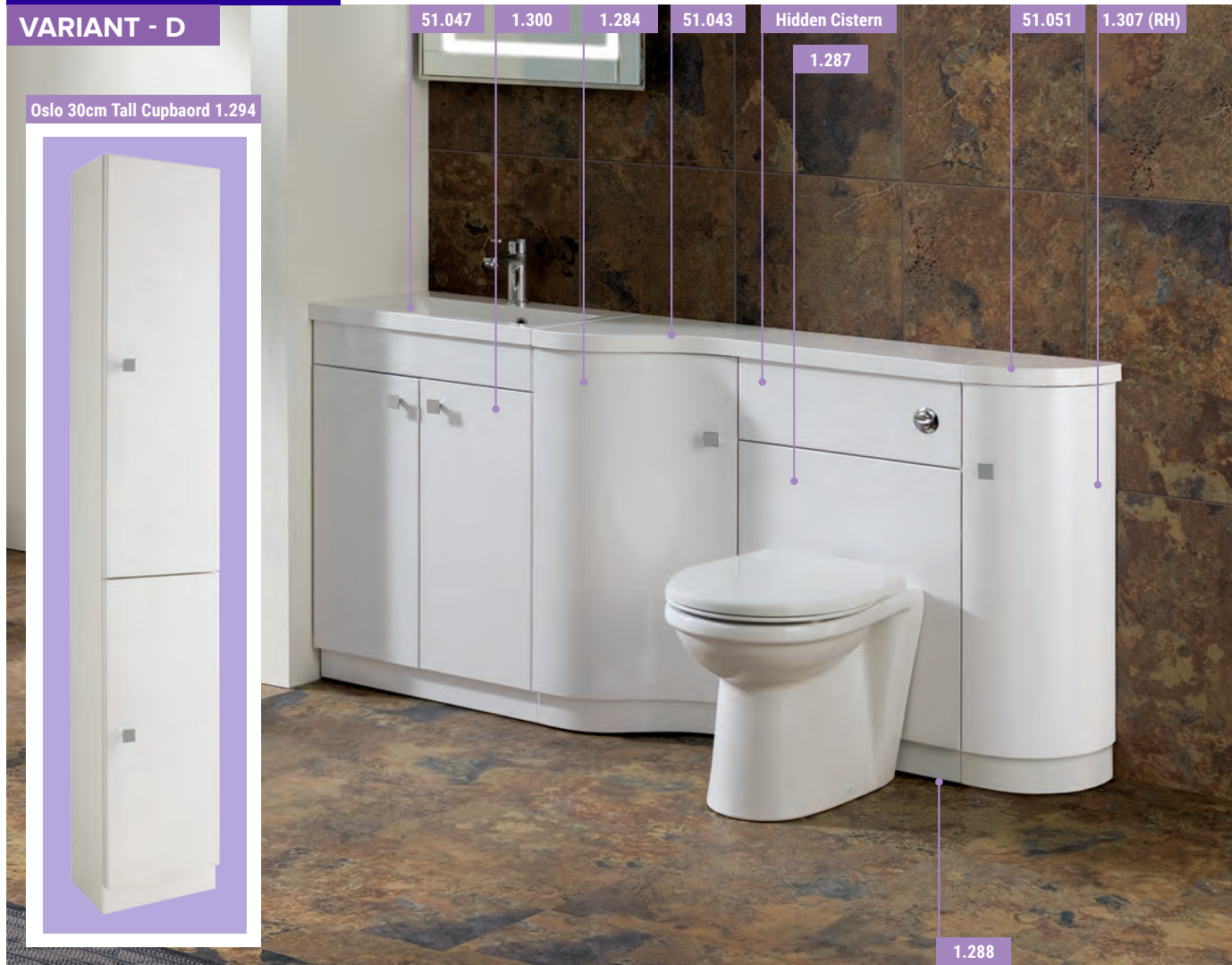

VARIANT - E



VARIANT - F



Oslo Combi Range

The Oslo Corner Combi collection is a clean, space efficient range that maximises storage. Choose from a selection of longer or shorter length set-ups to suit your taste and bathroom size.

Oslo Corner Combi			
Description	Code	£ Ex VAT	£ Inc VAT
Oslo Corner base unit LH	1.284	300.00	360.00
Oslo Corner base unit RH	1.285	300.00	360.00
Oslo Corner Combi single basin LH*	51.016	139.00	166.80
Oslo Corner Combi single basin RH*	51.017	139.00	166.80
Oslo Corner Combi long basin LH*	51.014	180.00	216.00
Oslo Corner Combi long basin RH*	51.015	180.00	216.00

*Due to depth of the waste area, the trap for external overflow kit & a flip top basin waste (unslotted) are recommended for installation.

Oslo Cabinets			
Description	Code	£ Ex VAT	£ Inc VAT
Oslo Curved Long top Plain LH	51.043	112.00	134.40
Oslo Curved Long top Plain RH	51.044	112.00	134.40
Oslo 30cm base cupboard, 1 door	1.293	117.00	140.40
Oslo 30cm tall cupboard, 2 door	1.294	283.00	339.60
Oslo curved end unit LH	1.306	199.00	238.80
Oslo curved end unit RH	1.307	199.00	238.80
Oslo Combi 580 door base unit	1.300	219.00	262.80

Oslo WC Unit			
Description	Code	£ Ex VAT	£ Inc VAT
Oslo WC unit only†	1.287	228.00	273.60
Oslo WC unit plinth	1.288	10.00	12.00
Plain infill panel 30 x 81cm	1.042	60.00	72.00

Oslo WC unit spares			
Description	Code	£ Ex VAT	£ Inc VAT
Upper panel for 1.287 Oslo WC unit	1.99070	65.00	78.00
Lower panel Oslo 50cm tall cistern unit	1.99046	59.00	70.80

For hidden cisterns see pages 234-235.

Plain Tops			
Description	Code	£ Ex VAT	£ Inc VAT
Oslo curved end top LH	51.049	206.00	247.20
Oslo curved end top RH	51.050	206.00	247.20
Oslo single quad top	51.051	66.00	79.20
Oslo 580 Combi basin top	51.047	132.00	158.40
Oslo Slab top 794	51.048	195.00	234.00
MDF WC Diamante 50cm top†	1.075	41.00	49.20
Oslo curved end unit LH	1.306	199.00	238.80
Oslo curved end unit RH	1.307	199.00	238.80

†Required 1.075 top and 1.288 plinth. *Due to depth of the waste area, the trap for external overflow kit & a flip top basin waste (unslotted) are recommended for installation.

Extras			
Description	Code	£ Ex VAT	£ Inc VAT
Trap for external overflow kit	7.0015	16.00	19.20
Flip Top Basin Waste - Unslotted	25.0005	12.00	14.40

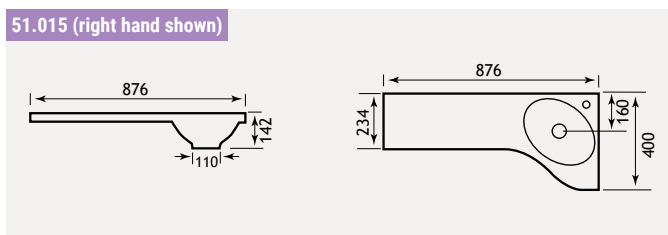
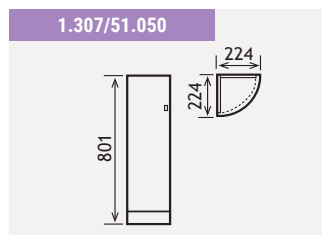
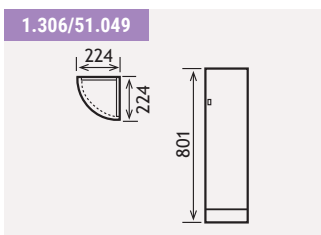
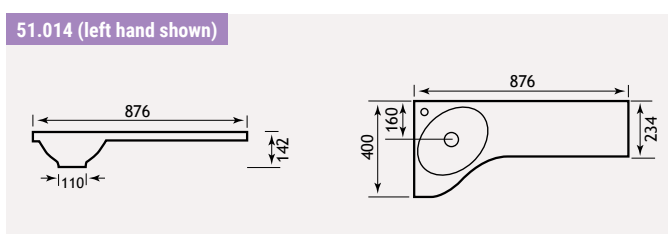
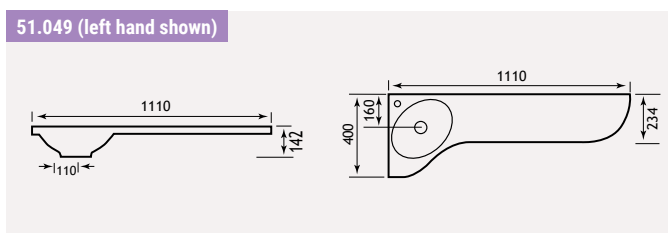
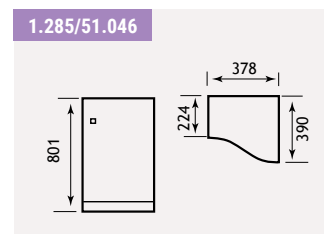
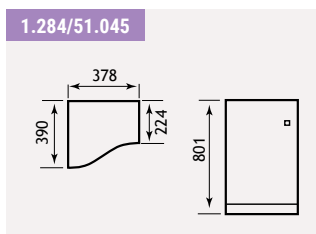
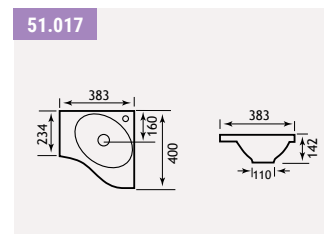
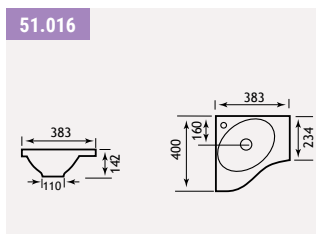
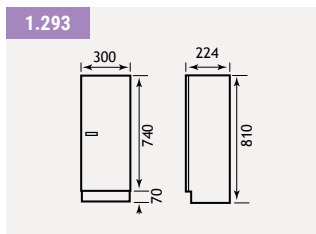
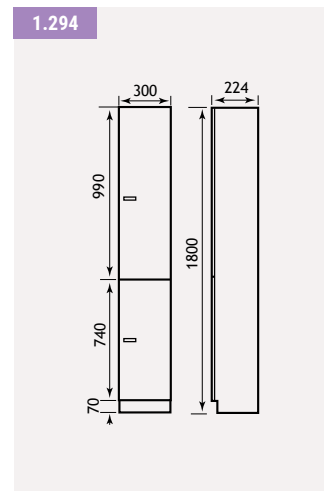
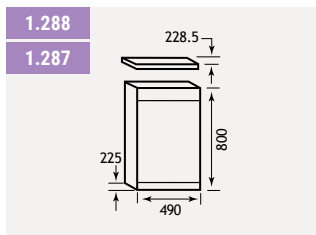

Oslo Semi Recessed Range

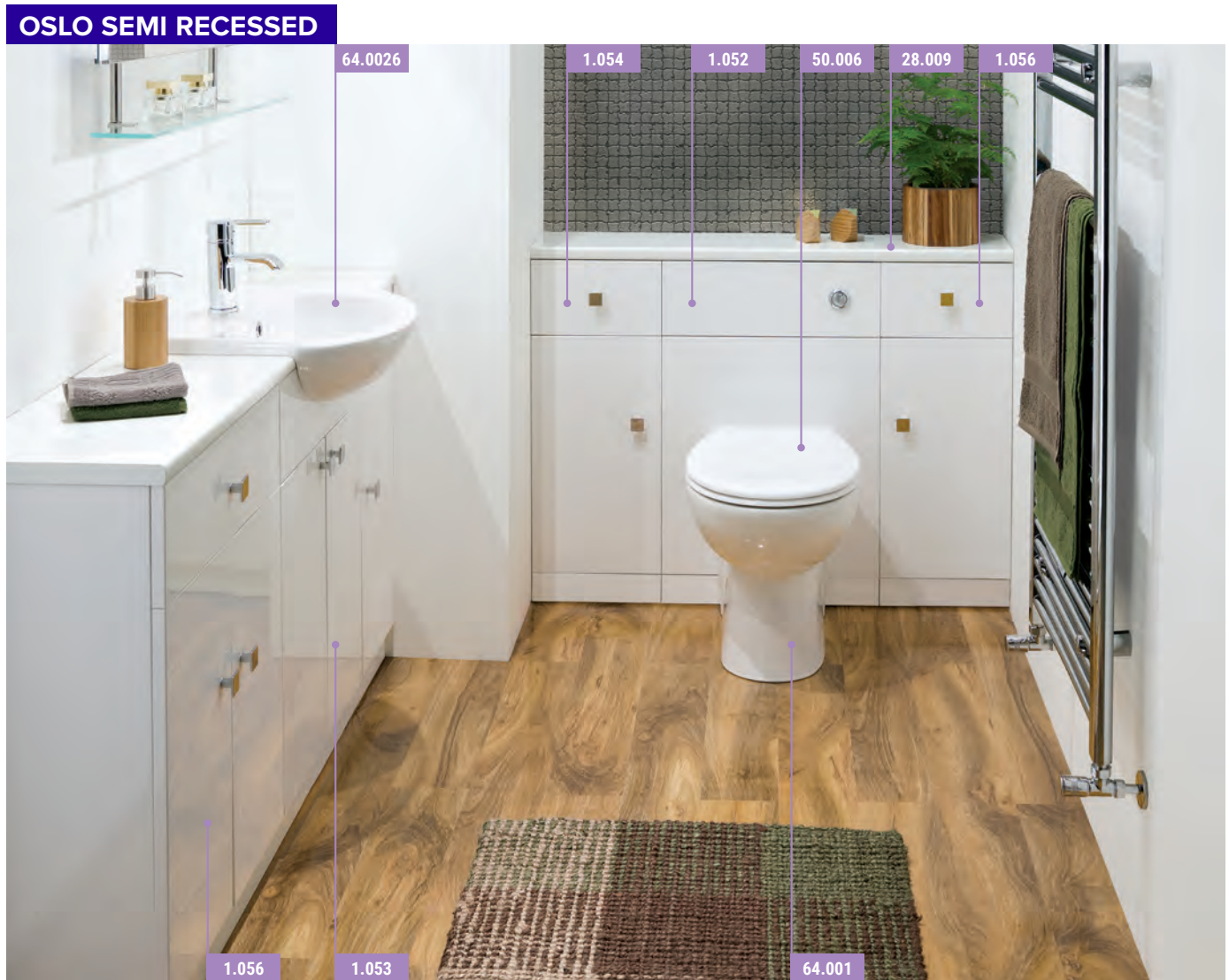

Oslo Semi Recessed			
Description	Code	£ Ex VAT	£ Inc VAT
Oslo 60cm WC unit	1.052	228.00	273.60
Oslo 60cm basin unit	1.053	206.00	247.20
Oslo 30cm base drawer unit LH	1.054	125.00	150.00
Oslo 60cm base cupboard with drawer	1.055	212.00	254.40
Oslo 30cm base drawer unit RH	1.056	125.00	150.00

Tops			
Description	Code	£ Ex VAT	£ Inc VAT
Laminate Tops Gloss 1000 x 310 mm	28.006	51.00	61.20
Laminate Tops Gloss 1200 x 310mm	28.009	59.00	70.80
Laminate Tops Gloss 1500 x 310 mm	28.007	59.00	70.80
Laminate Tops Gloss 2000 x 310 mm	28.008	100.00	120.00

Extras			
Description	Code	£ Ex VAT	£ Inc VAT
Colorado semi recessed basin 1TH	64.0026	113.00	135.60
Colorado Soft Close Seat	50.006	83.00	99.60
Colorado BTW WC pan	64.0001	94.00	112.80

For compatible semi-recessed basins see page 241.

Basin Unit

The upper panel is supplied uncut (for semi recessed basin)

1.028 / 1.037		
Width	Depth	Height
600mm	305mm	800mm

*Height excluding countertop and basin

Wall Cupboard

with two doors

1.034		
Width	Depth	Height
600mm	176mm	700mm

Base Unit with Drawer

All drawers have metal runners and all doors have metal adjustable hinges. RH shown

Left Hand -1.031 (OR) Right Hand - 1.030		
Width	Depth	Height
300mm	305mm	800mm

*excluding countertop

Concealed Cistern WC unit

with two removable fascia panels. The panels are not pre-drilled or cut (for greater flexibility when fitting)

1.029 / 1.037		
Width	Depth	Height
600mm	305mm	800mm

*Height excluding countertop and basin

Oslo Semi Recessed Slimline Range

OSLO SEMI RECESSED SLIMLINE



Oslo Semi Recessed Slimline

Description	Code	£ Ex VAT	£ Inc VAT
Oslo slimline basin unit *	1.051	206.00	247.20
Oslo WC unit only *	1.287	228.00	273.60
Oslo WC unit plinth	1.288	10.00	12.00
Laminate Tops Gloss 1200 x 310mm	28.005	59.00	70.80
Kompact reduced depth SR basin 1TH LH	27.0361	84.00	100.80
Kompact reduced depth SR basin 2TH	27.9361	84.00	100.80
Bonito 60cm plinth (height 70mm)	1.037	14.00	16.80

*No plinth supplied

Bonito Plinths

Description	Code	£ Ex VAT	£ Inc VAT
30cm Plinth (height 70mm)	1.011	12.00	14.40
60cm plinth (height 70mm)	1.037	14.00	16.80
90cm plinth (height 70mm)	1.038	15.00	18.00
120cm plinth (height 70mm)	1.039	16.00	19.20
150cm plinth (height 70mm)	1.040	18.00	21.60
180cm plinth (height 70mm)	1.041	19.00	22.80

Extras

Description	Code	£ Ex VAT	£ Inc VAT
Kompact reduced depth SR basin 1TH LH	27.0361	84.00	100.80
Kompact BTW pan	27.0321	120.00	144.00
Kompact soft close seat	21.1151	111.00	133.20

FEATURES

- Soft close system on doors and drawers

Slimline Basin Unit

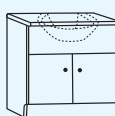

The upper panel is supplied uncut (for semi recessed basin)

1.028 / 1.037

Width	Depth	Height
600mm	255mm	800mm

*Height excluding countertop and basin

Oslo Tall Cistern

OSLO TALL CISTERN UNIT - WHITE

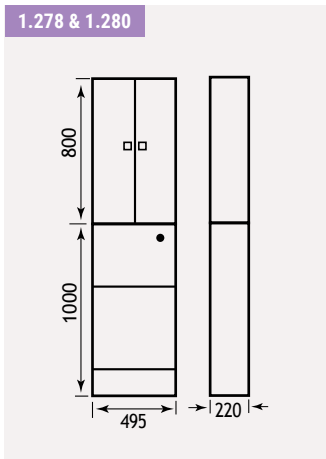
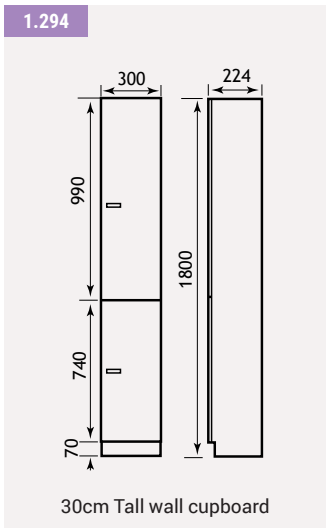
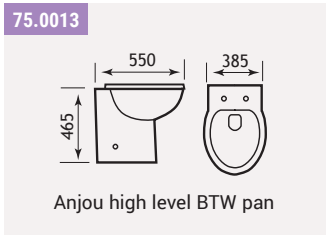

A high level cistern unit to complement the Anjou high level BTW pan. Available as a stand alone unit or with the option of two different size cupboards.

Oslo Tall Cistern Unit

Description	Code	£ Ex VAT	£ Inc VAT
Oslo tall cistern unit	1.278	273.00	327.60
Oslo tall cistern unit top	1.279	40.00	48.00
Oslo tall unit cupboard 500x800x220mm	1.280	184.00	220.80
Oslo tall unit cupboard 500x1000x220mm	1.281	210.00	252.00
Anjou High Level BTW pan	75.0013	270.00	324.00
Oslo tall unit cupboard 500 x 1000 x 200mm †	59.0007	197.00	236.40
Oslo 58cm door base unit	1.068	230.00	276.00
Oslo 58cm cast top	51.007	153.00	183.60
Rhone soft close seat	40.0001	57.00	68.40
Vantage Plain Hidden Cistern CP Push Button	17.001	133.00	159.60
Eastbrook Jacket Hidden Cistern - Bottom Inlet	53.001	82.00	98.40
Vantage Hidden Cistern with Jacket	17.3029	155.00	186.00
Oslo 30cm tall cupboard, 2 door	1.294	283.00	339.60

For hidden cisterns see pages 246-247

Oslo Tall Cistern Unit Spares

Description	Code	£ Ex VAT	£ Inc VAT
Lower panel Oslo 50cm tall cistern unit	1.99046	59.00	70.80
Upper panel Oslo 50cm tall cistern unit	1.99047	39.00	46.80

FEATURES

- Soft close system on doors

FEATURES - CAST MARBLE TOPS

- Made of 75% natural marble stone
- Repairable if chipped
- Seamless surface, easy to maintain

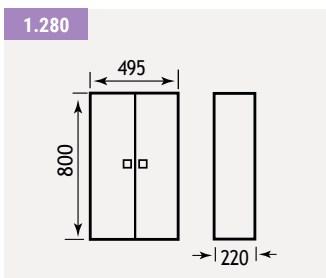
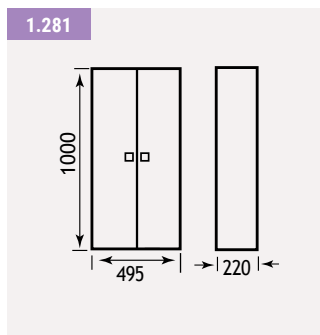

For wall mirrors and cabinets see pages 390-413

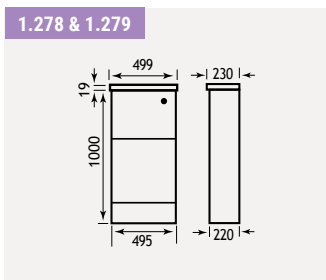

Oslo Tall Cistern

OSLO TALL CISTERN UNIT - MATT ANTHRACITE

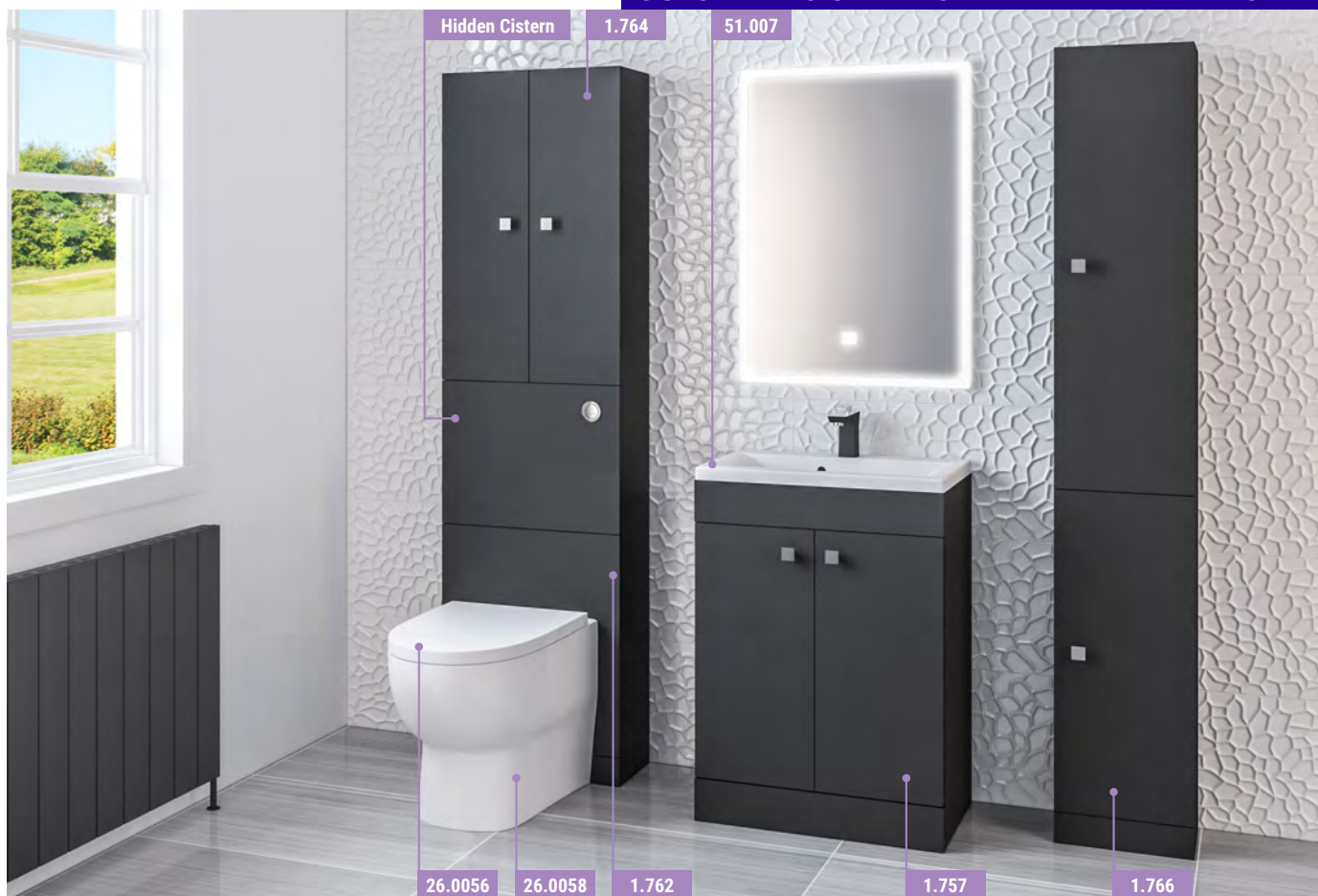

A high level cistern unit that adapts your bathroom storage needs into a spacesaving solution. Available as a stand alone unit or with the option of two different size cupboards.

Alternative basins see page 339.

Oslo Tall Cistern Unit - Matt Anthracite

Description	Code	£ Ex VAT	£ Inc VAT
Oslo tall cistern unit Matt Anthracite	1.762	273.00	327.60
Oslo tall cistern unit top Matt Anthracite	1.763	40.00	48.00
Oslo tall unit cupboard 500 x 800 Matt Anthracite	1.764	184.00	220.80
Oslo tall unit cupboard 500x1000 Matt Anthracite	1.765	210.00	252.00
Oslo 30cm tall cupboard Matt Anthracite	1.766	283.00	339.60
Oslo 58cm Matt Anthracite door base unit	1.757	230.00	276.00
Oslo 58 cast top *	51.007	153.00	183.60
Farringdon BTW pan	26.0058	147.00	176.40
Northall / Farringdon Wrap Over Soft Close Seat	26.0056	50.00	60.00
Vantage Plain Hidden Cistern CP Push Button	17.001	133.00	159.60
Eastbrook Jacket Hidden Cistern - Bottom Inlet	53.001	82.00	98.40
Vantage Hidden Cistern with Jacket	17.3029	155.00	186.00

Extras

Description	Code	£ Ex VAT	£ Inc VAT
Trap for external overflow kit	7.0015	16.00	19.20
Flip Top Basin Waste - Unslotted	25.0005	12.00	14.40

*Due to depth of waste area, trap for external overflow kit & flop top basin waste are recommended for installation.

FEATURES

- Soft close system on doors

FEATURES - CAST MARBLE TOPS

- Made of 75% natural marble stone
- Repairable if chipped
- Seamless surface, easy to maintain

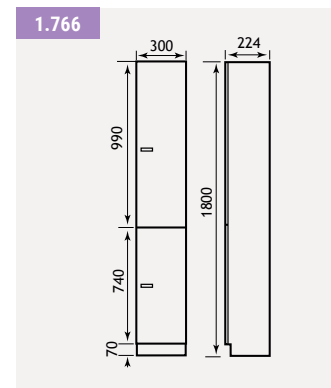
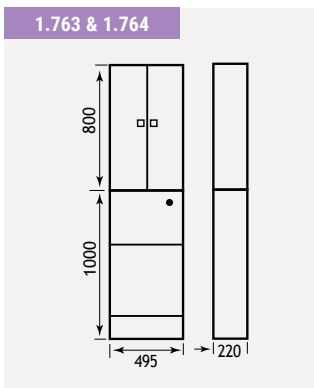
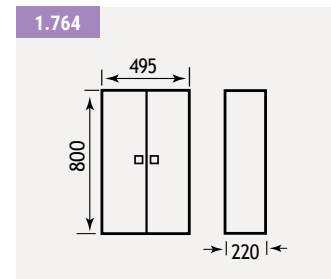
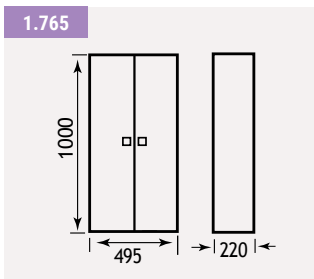
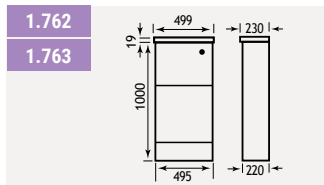
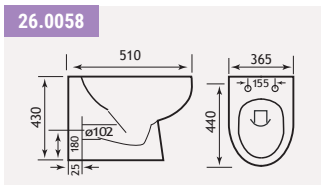

Oslo Tall Cistern



A high level cistern unit to complement the Anjou high level BTW pan. Available as a stand alone unit or with the option of two different size cupboards.

Oslo Tall Cistern Unit - Dark Walnut			
Description	Code	£ Ex VAT	£ Inc VAT
Oslo Tall Cistern Unit	59.0004	202.00	242.40
Oslo Tall Cistern Unit top	59.0005	35.00	42.00
Oslo tall unit cupboard 500 x 800 x 200mm †	59.0006	174.00	208.80
Oslo tall unit cupboard 500 x 1000 x 200mm †	59.0007	197.00	236.40
Anjou High Level BTW pan	75.0013	270.00	324.00
Rhone soft close seat	40.0001	57.00	68.40
Vantage Plain Hidden Cistern CP Push Button	17.001	133.00	159.60
Eastbrook Jacket Hidden Cistern - Bottom Inlet	53.001	82.00	98.40
Vantage Hidden Cistern with Jacket	17.3029	155.00	186.00

†Can be wall mounted as a stand alone unit.

Oslo 58 Unit - Dark Walnut			
Description	Code	£ Ex VAT	£ Inc VAT
Oslo 58cm door base unit	59.0002	256.00	307.20
Oslo 58 cast top*	51.007	153.00	183.60

*Due to depth of the waste area, the trap for external overflow kit & a flip top basin waste (unslotted) are recommended for installation.

Extras			
Description	Code	£ Ex VAT	£ Inc VAT
Trap for external overflow kit	7.0015	16.00	19.20
Flip Top Basin Waste - Unslotted	25.0005	12.00	14.40

See page 339 for alternative matching basins.
For hidden cisterns see pages 2246-247.

- FEATURES**
- Soft close system on doors and drawers
- FEATURES - CAST MARBLE TOPS**
- Made of 75% natural marble stone
 - Repairable if chipped
 - Seamless surface, easy to maintain

- FEATURES**
- Soft close system on doors and drawers
 - Separate shaver socket
 - Cornice has halogen spotlights
- FEATURES - CAST MARBLE TOPS**
- Made of 75% natural marble stone
 - Repairable if chipped
 - Seamless surface, easy to maintain

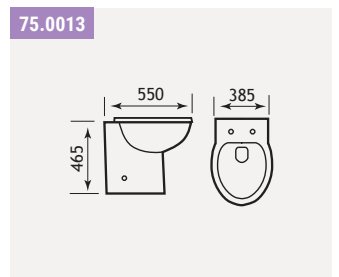
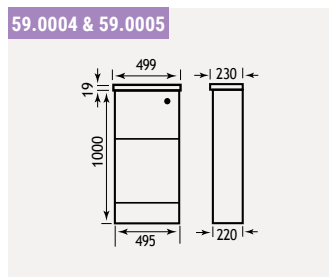
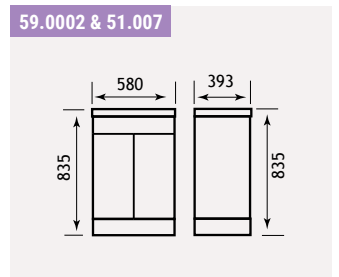
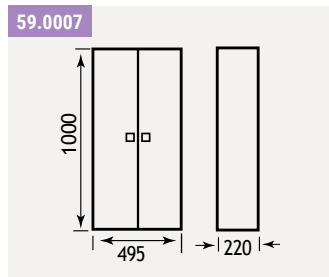
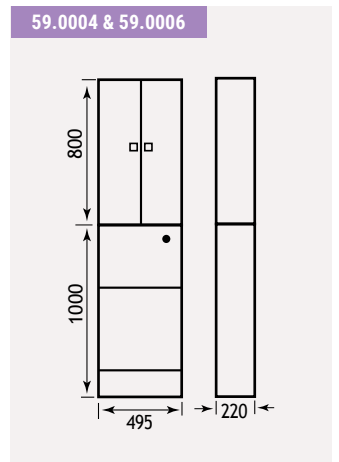
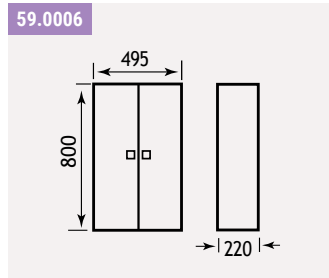

Oslo Reduced Depth

OSLO REDUCED DEPTH CISTERN UNIT



A new high level cistern to complement the Anjou high level BTW pan. Available as a stand alone unit or with the option of two different size cupboards.

Oslo 58 Base and Top

Description	Code	£ Ex VAT	£ Inc VAT
Oslo 58cm door base unit	1.068	230.00	276.00
Oslo 58 cast top *	51.007	153.00	183.60
Sorrento 45cm cornice **	1.520	136.00	163.20
Sorrento 40cm mirror †	1.418	87.00	104.40

*Due to depth of the waste area, the trap for external overflow kit & a flip top basin waste (unslotted) are recommended for installation. †Mirror must be fitted with a cornice. **During the life of this brochure the lights may change to LED.

Oslo Wide Cistern Unit

Description	Code	£ Ex VAT	£ Inc VAT
Oslo wide cistern unit	1.289	273.00	327.60
Oslo wide cistern unit top	1.290	40.00	48.00
Oslo wide wall cupboard 690x165x500	1.291	184.00	220.80
Oslo wide wall cupboard 690x165x700	1.292	210.00	252.00
Anjou High Level BTW pan	75.0013	270.00	324.00
Rhone soft close seat	40.0001	57.00	68.40

Oslo Wide Cistern Unit Spares

Description	Code	£ Ex VAT	£ Inc VAT
Lower panel Oslo wide cistern unit	1.99060	92.00	110.40
Upper panel Oslo wide cistern unit	1.99061	87.00	104.40

Extras

Description	Code	£ Ex VAT	£ Inc VAT
Trap for external overflow kit	7.0015	16.00	19.20
Flip Top Basin Waste - Unslotted	25.0005	12.00	14.40

See page 339 for alternative matching basins. For hidden cisterns see pages 246-247.

FEATURES

- Soft close system on doors and drawers
 - Separate shaver socket
 - Cornice has halogen spotlights
- ### FEATURES - CAST MARBLE TOPS
- Made of 75% natural marble stone
 - Repairable if chipped
 - Seamless surface, easy to maintain

1.068 & 51.007

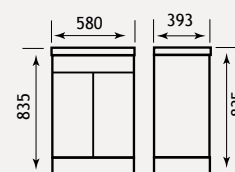

1.290 & 1.289

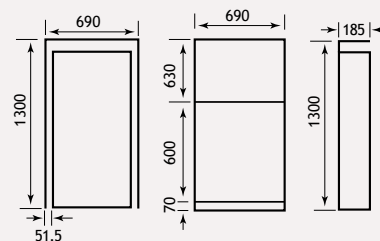

Oslo Wall Hung

OSLO 39 WALL HUNG UNITS



Pictured - 390 Double Height Wall Hung Unit

29.0148

51.005

29.0138

29.0178

NORTHALL RIMLESS PAN Complete the LOOK
SEE PAGES 222-223

Oslo 39 Wall Hung Units

Description	Code	£ Ex VAT	£ Inc VAT
Oslo 390 Shallow Height Wall Hung Unit	29.0138	64.00	76.80
Oslo 390 Double Height Wall Hung Door Unit	29.0148	117.00	140.40
Oslo/Faro 39 cast top*	51.005	120.00	144.00
Oslo 1400 x 300 x 259 Two Door Wall Unit †	29.0178	234.00	280.80

*Due to depth of the waste area, the trap for external overflow kit & a flip top basin waste (unslotted) are recommended for installation. †Doors can be rehanded on installation.

Extras

Description	Code	£ Ex VAT	£ Inc VAT
Trap for external overflow kit	7.0015	16.00	19.20
Flip Top Basin Waste - Unslotted	25.0005	12.00	14.40

FEATURES

- Soft close system on doors and drawers

FEATURES - CAST MARBLE TOPS

- Made of 75% natural marble stone
- Repairable if chipped
- Seamless surface, easy to maintain

51.005

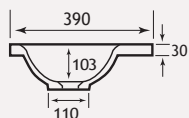

29.0178

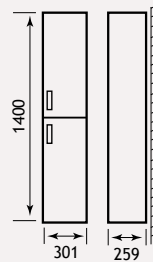

29.0148

29.0148

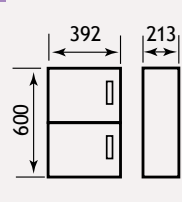

29.0138

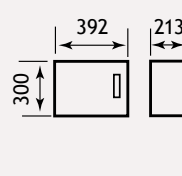

29.0138

Oslo Wall Hung

OSLO 44 WALL HUNG UNITS



51.006

29.0158

29.0178

Oslo 44 Wall Hung Units

Description	Code	£ Ex VAT	£ Inc VAT
Oslo 440 Two Drawer Wall Hung Unit	29.0158	217.00	260.40
Oslo 44 cast top*	51.006	139.00	166.80
Oslo 1400 x 300 x 259 Two Door Wall Unit†	29.0178	234.00	280.80

*Due to depth of the waste area, the trap for external overflow kit & a flip top basin waste (unslotted) are recommended for installation. †Doors can be rehanded on installation.

Extras

Description	Code	£ Ex VAT	£ Inc VAT
Trap for external overflow kit	7.0015	16.00	19.20
Flip Top Basin Waste - Unslotted	25.0005	12.00	14.40

FEATURES

- Soft close system on doors and drawers

FEATURES - CAST MARBLE TOPS

- Made of 75% natural marble stone
- Repairable if chipped
- Seamless surface, easy to maintain



29.0158

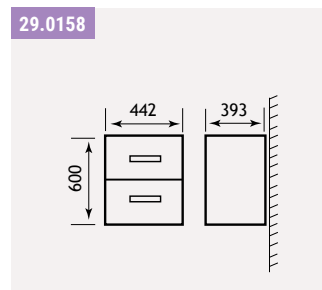

29.0158

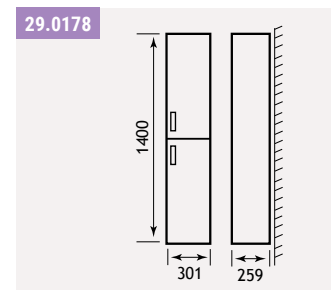

29.0178

51.006

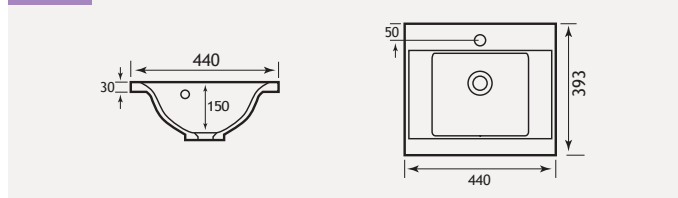

Oslo Wall Hung

OSLO 58 WALL HUNG UNITS



51.007

29.0168

29.0178

Oslo 58 Wall Hung Units

Description	Code	£ Ex VAT	£ Inc VAT
Oslo 580 Two Drawer Wall Hung Unit	29.0168	227.00	272.40
Oslo 58 cast top*	51.007	153.00	183.60
Oslo 1400 x 300 x 259 Two Door Wall Unitt	29.0178	234.00	280.80

*Due to depth of the waste area, the trap for external overflow kit & a flip top basin waste (unslotted) are recommended for installation. †Doors can be rehanded on installation.

Extras

Description	Code	£ Ex VAT	£ Inc VAT
Trap for external overflow kit	7.0015	16.00	19.20
Flip Top Basin Waste - Unslotted	25.0005	12.00	14.40

FEATURES

- Soft close system on doors and drawers

FEATURES - CAST MARBLE TOPS

- Made of 75% natural marble stone
- Repairable if chipped
- Seamless surface, easy to maintain



29.0168

29.0168

29.0178

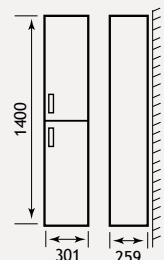
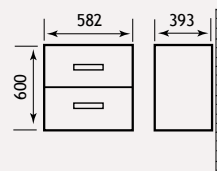

SEVILLE TABLEAU - HIGH GLOSS WHITE



56.1075

52.120

1.324

51.032

Seville Tableau 1000 High gloss white with optional side towel rail

A contemporary take on the bathroom unit this minimalist shelf will transform your bathroom, supplied with wall brackets.

Seville Vanity Tableau in High Gloss White

Description	Code	£ Ex VAT	£ Inc VAT
Seville 500 vanity tableau inc wall bracket	1.321	259.00	310.80
Seville 600 vanity tableau inc wall brackets	1.322	288.00	345.60
Seville 800 vanity tableau inc wall bracket	1.323	341.00	409.20
Seville 1000 vanity tableau inc wall bracket	1.324	399.00	478.80
Rondo sit on basin 412	51.032	147.00	176.40
Bowmont 600 x 500 LED mirror	56.1075	267.00	320.40

Optional Towel Rails See Picture Above

Description	Code	£ Ex VAT	£ Inc VAT
Single towel rail 450mm Chrome	52.117	39.00	46.80
Single Towel Rail 550mm Chrome	52.118	40.00	48.00
Single Towel Rail 750mm Chrome	52.119	44.00	52.80
Single Towel Rail 950mm Chrome	52.120	48.00	57.60

FEATURES

- Hidden wall brackets
- Different colour options available



Pictured - Seville Tableau 500 High Gloss White

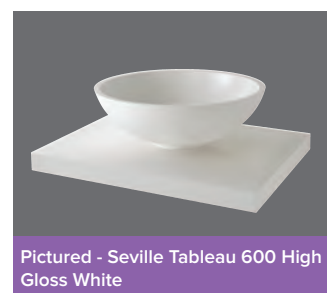

Pictured - Seville Tableau 600 High Gloss White



Pictured - Seville Tableau 800 High Gloss White

1.321



1.322

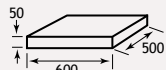

1.323

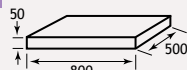

1.324

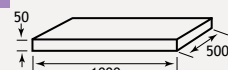

Seville

SEVILLE TABLEAU - ANTHRACITE



Seville Tableau 800 Anthracite with optional front towel rail.

SEVILLE TABLEAU - WASHED ASH



Seville Tableau 1000 Washed Ash

Seville Vanity Tableau In Anthracite

Description	Code	£ Ex VAT	£ Inc VAT
Seville 500 vanity tableau inc wall bracket†	1.308	234.00	280.80
Seville 600 vanity tableau in wall bracket†	1.310	234.00	280.80
Seville 800 vanity tableau inc wall bracket†	1.311	270.00	324.00
Rondo sit on basin 412	51.032	147.00	176.40
Bowmont 600 x 500 LED mirror	56.1075	267.00	320.40

†While stocks last

Optional Towel Rails See Picture Above

Description	Code	£ Ex VAT	£ Inc VAT
Single towel rail 450mm Chrome	52.117	39.00	46.80
Single Towel Rail 550mm Chrome	52.118	40.00	48.00
Single Towel Rail 750mm Chrome	52.119	44.00	52.80
Single Towel Rail 950mm Chrome	52.120	48.00	57.60

Seville Vanity Tableau In Washed Ash

Description	Code	£ Ex VAT	£ Inc VAT
Seville 500 vanity tableau inc wall bracket†	1.313	234.00	280.80
Seville 600 vanity tableau inc wall bracket†	1.315	248.00	297.60
Seville 800 vanity tableau inc wall bracket†	1.319	270.00	324.00
Seville 1000 vanity tableau inc wall bracket†	1.320	292.00	350.40
Rondo sit on basin 412	51.032	147.00	176.40
Bowmont 600 x 500 LED mirror	56.1075	267.00	320.40

†While stocks last

Optional Towel Rails See Picture Above

Description	Code	£ Ex VAT	£ Inc VAT
Single towel rail 450mm Chrome	52.117	39.00	46.80
Single Towel Rail 550mm Chrome	52.118	40.00	48.00
Single Towel Rail 750mm Chrome	52.119	44.00	52.80
Single Towel Rail 950mm Chrome	52.120	48.00	57.60



Pictured - Seville Tableau 500 Anthracite



Pictured - Seville Tableau 800 Anthracite



Pictured - Seville Tableau 500 Washed Ash



Pictured - Seville Tableau 800 Washed Ash

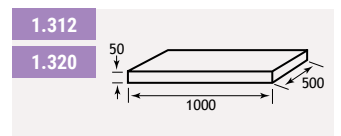
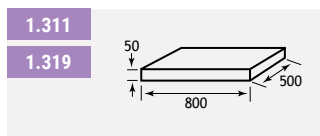
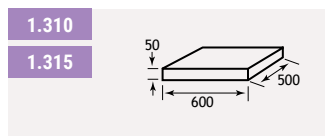
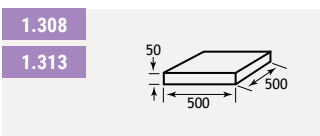

Sorrento Slab

SORRENTO SLAB 45



Sorrento Slab 45 high gloss white with Rondo sit on basin (see page 224)

A modern design of a traditional concept with soft close hinges, adjustable feet and solid ceramic top which accommodates a variety of sit-on basins.

Sorrento Slab 45			
Description	Code	£ Ex VAT	£ Inc VAT
Sorrento 41cm base unit *	1.510	250.00	300.00
Sorrento 45 Slab top	51.035	95.00	114.00
Rondo sit on basin 412	51.032	147.00	176.40
Prado 550 high rise mono basin	56.2002	95.00	114.00
Sorrento short legs - pack of 4	1.305	20.00	24.00

*1.305 shorter legs are advised when using slab top on floor mounted units to compensate for extra height of sit-on basin.

FEATURES

- Soft close system on doors
- Adjustable legs 50-70mm - short
- Adjustable legs 120-130mm - standard

FEATURES - SIT ON BASINS

- Made of 75% natural marble stone
- Repairable if chipped
- Seamless surface, easy to maintain

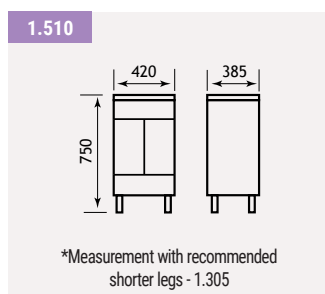
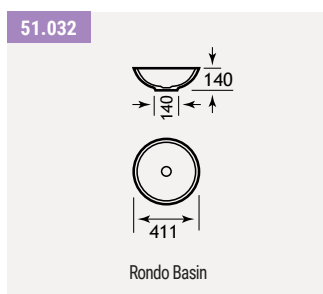

SORRENTO SLAB 60



Sorrento Slab 60 high gloss white, with Natura basin (see page 224)

A modern design of a traditional concept with soft close hinges, adjustable feet and solid ceramic top which accommodates a variety of sit-on basins.

Sorrento Slab 60			
Description	Code	£ Ex VAT	£ Inc VAT
Sorrento/Faro 56cm base unit *	1.512	310.00	372.00
Sorrento 60 Slab top	51.036	118.00	141.60
Natura sit on basin 500x400	51.030	147.00	176.40
Prado 550 high rise mono basin	56.2002	95.00	114.00
Sorrento short legs - pack of 4	1.305	20.00	24.00

*1.305 shorter legs are advised when using slab top on floor mounted units to compensate for extra height of sit-on basin.

FEATURES

- Soft close system on doors and drawers
- Adjustable legs 50-70mm - short
- Adjustable legs 120-130mm - standard

FEATURES - SIT ON BASINS

- Made of 75% natural marble stone
- Repairable if chipped
- Seamless surface, easy to maintain

For wall mirrors and cabinets see pages 388-413

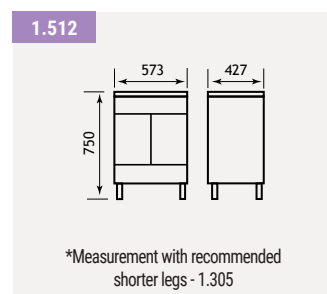
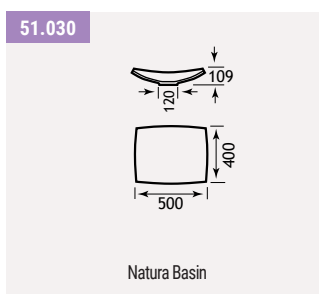

Sorrento Slab

SORRENTO SLAB 80



Sorrento Slab 80 high gloss white, with Rondo basin (see page 236).

A modern design of a traditional concept with soft close hinges, adjustable feet and a solid slab top which accommodates a variety of sit-on basins.

Sorrento Slab 80

Description	Code	£ Ex VAT	£ Inc VAT
Sorrento/Faro 76cm base unit *	1.514	351.00	421.20
Sorrento 80 Slab top	51.037	134.00	160.80
Rondo sit on basin 412	51.032	147.00	176.40
Renata sit on basin 430	51.029	132.00	158.40
Estorick high rise mono basin	56.2037	150.00	180.00
Sorrento short legs - pack of 4	1.305	20.00	24.00

*1.305 shorter legs are advised when using slab top on floor mounted units to compensate for extra height of sit-on basin.

For wall mirrors and cabinets see pages 388-413

FEATURES

- Soft close system on doors and drawers
- Adjustable legs 50-70mm - short
- Adjustable legs 120-130mm - standard

FEATURES - SIT ON BASINS

- Made of 75% natural marble stone
- Repairable if chipped
- Seamless surface, easy to maintain

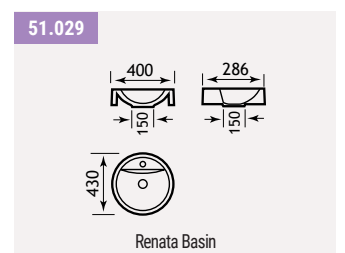
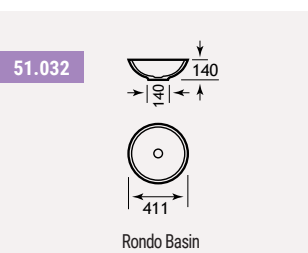
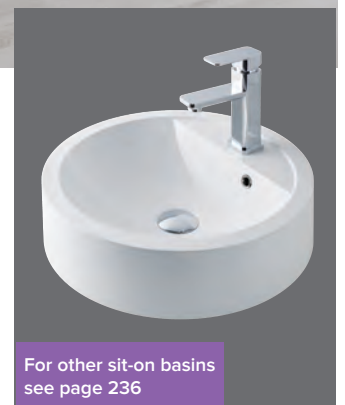
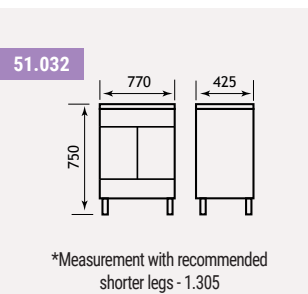

Sorrento Slab

SORRENTO SLAB 100

1.516

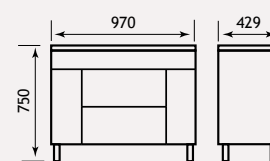

*Measurement with recommended shorter legs - 1.305



Sorrento Slab 100 high gloss white, with Rondo basin (see page 224).

A modern design of a traditional concept with soft close hinges, adjustable feet and a solid slab top which accommodates a variety of sit-on basins.

Sorrento Slab 100

Description	Code	£ Ex VAT	£ Inc VAT
Sorrento/Faro 96cm base unit *	1.516	419.00	502.80
Sorrento 96cm wall hung unit	1.716	414.00	496.80
Sorrento 100 Slab top	51.038	157.00	188.40
Rondo sit on basin 412	51.032	147.00	176.40
Natura sit on basin 500x400	51.030	147.00	176.40
Estorick high rise mono basin	56.2037	150.00	180.00
Sorrento short legs - pack of 4	1.305	20.00	24.00

*1.305 shorter legs are advised when using slab top on floor mounted units to compensate for extra height of sit-on basin.

For wall mirrors and cabinets see pages 388-413

FEATURES

- Soft close system on doors and drawers
- Adjustable legs 50-70mm - short
- Adjustable legs 120-130mm - standard

FEATURES - SIT ON BASINS

- Made of 75% natural marble stone
- Repairable if chipped
- Seamless surface, easy to maintain



For other sit-on basins see page 236

51.032

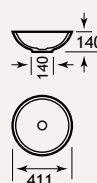

Rondo Basin

51.029

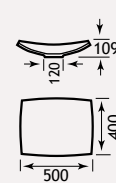

Natura Basin

Sorrento

SORRENTO 45



Sorrento 45 base unit high gloss white. Also available as wall hung unit, see page 379.

SORRENTO 60



Sorrento 60 base unit high gloss white. Also available as wall hung unit, see page 380.

A modern design of a traditional concept with soft close hinges, adjustable feet and solid ceramic top.

A modern design of a traditional concept with soft close hinges, adjustable feet and solid ceramic top.

Sorrento 45

Description	Code	£ Ex VAT	£ Inc VAT
Sorrento 41cm base unit	1.510	250.00	300.00
Sorrento 40cm mirror *	1.418	87.00	104.40
Sorrento 45cm cornice †	1.520	136.00	163.20
Sorrento 45cm Ceramic top	26.0088	74.00	88.80
Prado 500 Basin Mono (inc Waste)	79.0060	63.00	75.60

*Mirror must be fitted with a cornice. †During the life of this brochure the lights may change to LED.

For wall mirrors and cabinets see pages 390-413

FEATURES

- Soft close system on doors and drawers
- Separate shaver socket
- Chrome spotlights
- Adjustable legs on floor standing models 120-130mm



All Sorrento cornices include separate shaver sockets and chrome spots.

26.0088

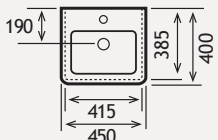

1.418

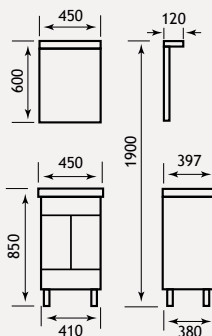

1.510

Sorrento 60

Description	Code	£ Ex VAT	£ Inc VAT
Sorrento/Faro 56cm base unit	1.512	310.00	372.00
Sorrento 40cm mirror *	1.418	87.00	104.40
Sorrento 60cm cornice †	1.521	156.00	187.20
Sorrento 60cm Ceramic top	26.0089	96.00	115.20
Prado 500 Basin Mono (inc Waste)	79.0060	63.00	75.60

*Mirror must be fitted with a cornice. †During the life of this brochure the lights may change to LED.

For wall mirrors and cabinets see pages 390-413

FEATURES

- Soft close system on doors and drawers
- Separate shaver socket
- Chrome spotlights
- Adjustable legs on floor standing models 120-130mm

26.0089

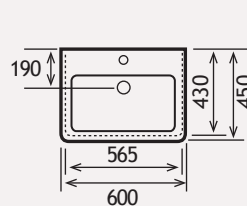

1.418

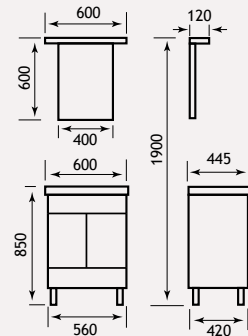

1.512

Sorrento

SORRENTO 80

A modern design of a traditional concept with soft close hinges, adjustable feet and solid ceramic top.

Sorrento 80

Description	Code	£ Ex VAT	£ Inc VAT
Sorrento/Faro 76cm base unit	1.514	351.00	421.20
Sorrento 80cm Ceramic Top	83.0019	124.00	148.80
Sorrento 70cm mirror*	1.419	118.00	141.60
Sorrento 80cm cornice †	1.522	185.00	222.00
Sorrento 800mm 'Wave' action infra red cornice †	1.219	234.00	280.80

*Mirror must be fitted with a cornice. †During the life of this brochure the lights may change to LED.

FEATURES

- Soft close system on doors and drawers
- Separate shaver socket
- Adjustable legs on floor standing models 120-130mm



1.419

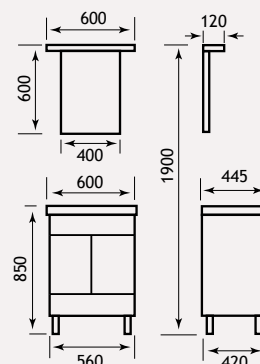

1.514

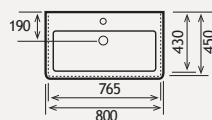

Sorrento 80 base unit high gloss white. Also available as wall hung unit, see page 380.

26.0090

Sorrento

SORRENTO 100



Sorrento 100 base unit high gloss white. Also available as wall hung unit, see page 382.

1.522

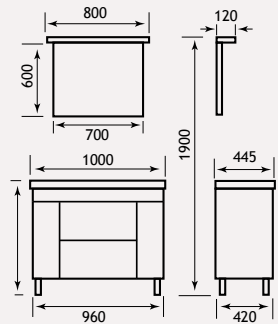

1.516

83.0020

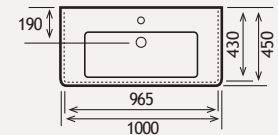

The Sorrento range features adjustable legs. 120-130mm

A modern design of a traditional concept with soft close hinges, adjustable feet and solid ceramic tops.

*Mirror must be fitted with a cornice. †During the life of this brochure the lights may change to LED.

Sorrento 100			
Description	Code	£ Ex VAT	£ Inc VAT
Sorrento/Faro 96cm base unit	1.516	419.00	502.80
Sorrento 100cm ceramic top	83.0020	142.00	170.40
Sorrento 70cm mirror*	1.419	118.00	141.60
Sorrento 80cm cornice †	1.522	185.00	222.00
Sorrento 800mm 'Wave' action infra red cornice †	1.219	234.00	280.80

FEATURES

- Soft close system on doors
- Separate shaver socket
- Chrome spotlights
- Adjustable legs on floor standing models 120-130mm

For wall mirrors and cabinets see pages 390-413

Sorrento Ceramic Tops

SORRENTO 45

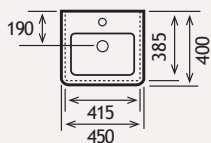

26.0088



450 x 397mm

Sorrento basins offer a flexible design option for numerous modern applications.

Sorrento 45

Description	Code	£ Ex VAT	£ Inc VAT
Sorrento 45cm Ceramic top	26.0088	74.00	88.80
Ceramic Top Basin Waste	45.0000	17.00	20.40

SORRENTO 60

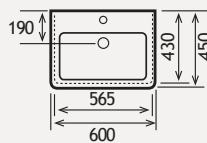

26.0089



600 x 445mm

Sorrento basins offer a flexible design option for numerous modern applications.

Sorrento 60

Description	Code	£ Ex VAT	£ Inc VAT
Sorrento 60cm Ceramic top	26.0089	96.00	115.20
Ceramic Top Basin Waste	45.0000	17.00	20.40

SORRENTO 80

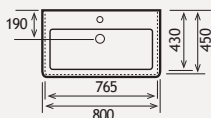

26.0090



450 x 397mm

Sorrento basins offer a flexible design option for numerous modern applications.

Sorrento 80

Description	Code	£ Ex VAT	£ Inc VAT
Sorrento 80cm Ceramic top	26.0090	124.00	148.80
Ceramic Top Basin Waste	45.0000	17.00	20.40

SORRENTO 100 SINGLE BOWL

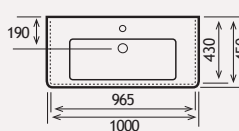

83.0020



600 x 445mm

Sorrento basins offer a flexible design option for numerous modern applications.

Sorrento 100 Single Bowl

Description	Code	£ Ex VAT	£ Inc VAT
Sorrento 100cm ceramic top	83.0020	142.00	170.40
Ceramic Top Basin Waste	45.0000	17.00	20.40

Sorrento Wall Hung

SORRENTO SLAB 45



Sorrento Slab 45 wall hung high gloss white

A modern design of a traditional concept with soft close hinges and solid ceramic top which accommodates a variety of sit-on basins.

Sorrento Slab 45 Wall-Hung

Description	Code	£ Ex VAT	£ Inc VAT
Sorrento 41cm wall hung unit	1.710	248.00	297.60
Sorrento 45 Slab top	51.035	95.00	114.00
Rondo sit on basin 412	51.032	147.00	176.40
Prado 550 high rise mono basin	56.2002	95.00	114.00

FEATURES

- Soft close system drawers

FEATURES - SIT ON BASINS

- Made of 75% natural marble stone
- Repairable if chipped
- Seamless surface, easy to maintain

Renata sit-on basin 236

For other sit-on basins see page 236

For wall mirrors and cabinets see pages 390-413

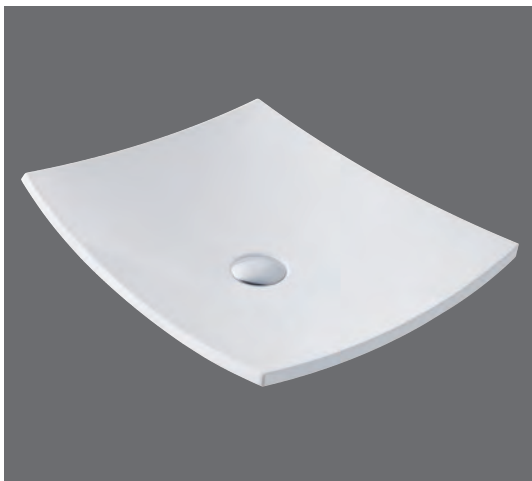

51.032 - Rondo

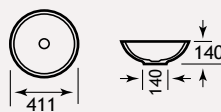

1.710

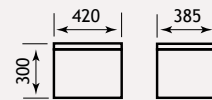

51.030 - Natura

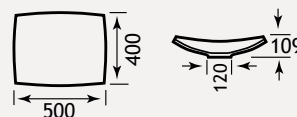

Sorrento Wall Hung

SORRENTO SLAB 60



Sorrento Slab 60 wall hung high gloss white, with Rondo basin.

SORRENTO SLAB 80



Sorrento Slab 80 wall hung high gloss white, with Rondo basin.

A modern design of a traditional concept with soft close hinges and a solid slab top which accommodates a variety of sit-on basins.

Sorrento Slab 60 Wall-Hung

Description	Code	£ Ex VAT	£ Inc VAT
Sorrento 56cm wall hung unit	1.712	307.00	368.40
Sorrento 60 Slab top	51.036	118.00	141.60
Rondo sit on basin 412	51.032	147.00	176.40
Natura sit on basin 500x400	51.030	147.00	176.40
Prado 550 high rise mono basin	56.2002	95.00	114.00

FEATURES

- Soft close system on drawers

FEATURES - SIT ON BASINS

- Made of 75% natural marble stone
- Repairable if chipped
- Seamless surface, easy to maintain

For other sit-on basins see page 236

A modern design of a traditional concept with soft close hinges and a solid slab top which accommodates a variety of sit-on basins.

Sorrento Slab 80 Wall-Hung

Description	Code	£ Ex VAT	£ Inc VAT
Sorrento 76cm wall hung unit	1.714	347.00	416.40
Sorrento 80 Slab top	51.037	134.00	160.80
Rondo sit on basin 412	51.032	147.00	176.40
Prado 550 high rise mono basin	56.2002	95.00	114.00

FEATURES

- Soft close system on drawers

FEATURES - SIT ON BASINS

- Made of 75% natural marble stone
- Repairable if chipped
- Seamless surface, easy to maintain

For other sit-on basins see page 236

1.712

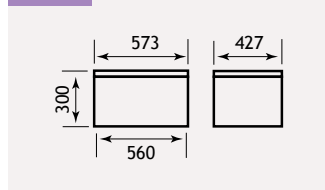

51.030 - Natura

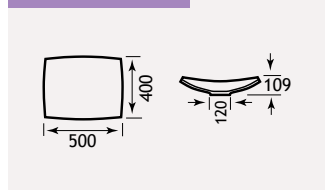

1.714

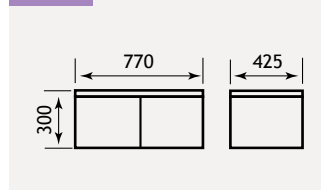

51.029 - Renata

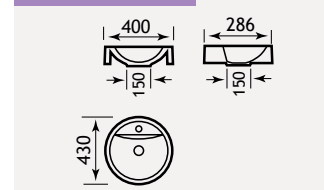

51.032 - Rondo

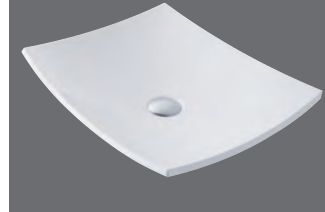
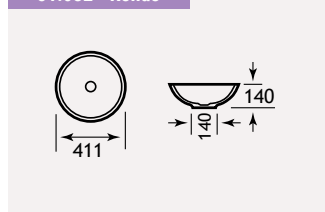

Sorrento Wall Hung

SORRENTO SLAB 100



Sorrento Slab 100 wall hung high gloss white with Rondo basin.

Sorrento Slab 100 Wall-Hung

Description	Code	£ Ex VAT	£ Inc VAT
Sorrento 96cm wall hung unit	1.716	414.00	496.80
Sorrento 100 Slab top	51.038	157.00	188.40
Rondo sit on basin 412	51.032	147.00	176.40
Estorick high rise mono basin	56.2037	150.00	180.00

FEATURES

- Mirror has LED lights and a built-in clock
- Adjustable legs on floor standing models

FEATURES - SIT ON BASINS

- Made of 75% natural marble stone
- Repairable if chipped
- Seamless surface, easy to maintain

For wall mirrors and cabinets see pages 390-413

51.030 - Natura

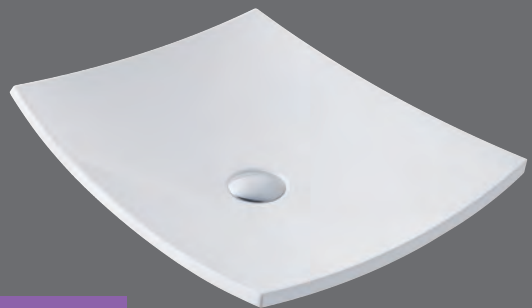

For other sit-on basins see page 236

51.032 - Rondo



51.030 - Natura

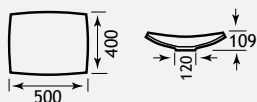

1.716

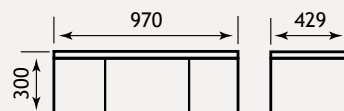

Sorrento Wall Hung

SORRENTO 45 WALL HUNG

A modern design of a traditional concept with soft close hinges, and solid ceramic top.

FEATURES

- Soft close system on doors and drawers
- Separate shaver socket



Sorrento 45 wall-hung high gloss white.



All Sorrento cornices include separate shaver sockets and chrome spots.

Sorrento 45 Wall-Hung

Description	Code	£ Ex VAT	£ Inc VAT
Sorrento 41cm wall hung unit	1.710	248.00	297.60
Sorrento 40cm mirror *	1.418	87.00	104.40
Sorrento 45cm cornice **	1.520	136.00	163.20
Sorrento 45cm Ceramic top	26.0088	74.00	88.80

*Mirror must be fitted with a cornice. ** During the life of this brochure lights may change to LED.

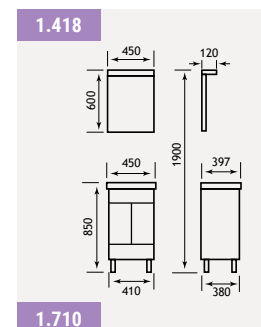
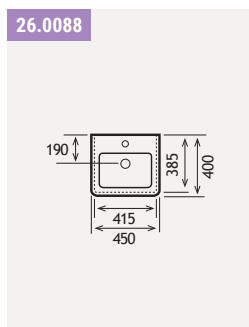

Sorrento Wall Hung

SORRENTO 60 WALL HUNG



Sorrento 60 wall-hung
high gloss white

A modern design of a traditional concept with soft close hinges and solid ceramic top.

FEATURES

- Soft close system on drawers
- Separate shaver socket

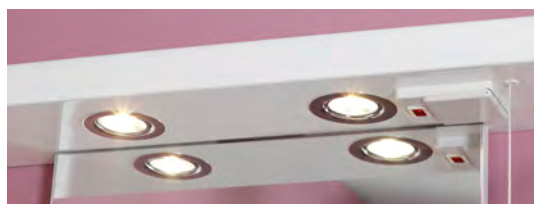

All Sorrento cornices include separate shaver sockets and chrome spots.

26.0089

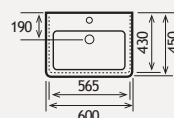

1.418

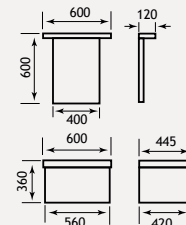

1.712

Sorrento 60 Wall-Hung

Description	Code	£ Ex VAT	£ Inc VAT
Sorrento 56cm wall hung unit	1.712	307.00	368.40
Sorrento 40cm mirror *	1.418	87.00	104.40
Sorrento 60cm cornice **	1.521	156.00	187.20
Sorrento 60cm Ceramic top	26.0089	96.00	115.20

*Mirror must be fitted with a cornice. ** During the life of this brochure lights may change to LED.

Sorrento Wall Hung

SORRENTO 80 WALL HUNG

A modern design of a traditional concept with soft close hinges and solid ceramic top.

FEATURES

- Soft close system on drawers
- Separate shaver socket



Sorrento 80 wall-hung high gloss white

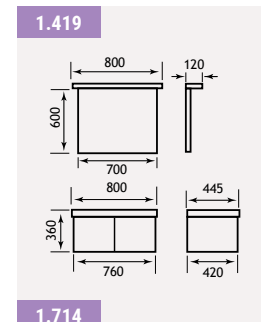
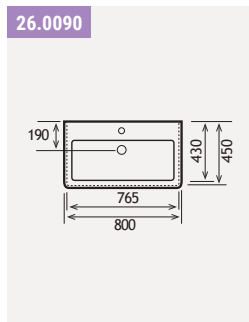

Sorrento 80 Wall-Hung			
Description	Code	£ Ex VAT	£ Inc VAT
Sorrento 76cm wall hung unit	1.714	347.00	416.40
Sorrento 70cm mirror *	1.419	118.00	141.60
Sorrento 80cm cornice **	1.522	185.00	222.00
Sorrento 800mm 'Wave' action infra red cornice **	1.219	234.00	280.80
Sorrento 80cm Ceramic Top	26.0090	124.00	148.80

*Mirror must be fitted with a cornice. ** During the life of this brochure lights may change to LED.

Sorrento Wall Hung

SORRENTO 100 WALL HUNG



Sorrento 1000mm wall-hung unit in high gloss white. Tap shown for illustration purposes only.

Simply stunning. This superb 100 wall-hung unit can only be used with the single bowl ceramic top option.

Sorrento 100 Wall-Hung

Description	Code	£ Ex VAT	£ Inc VAT
Sorrento 96cm wall hung unit	1.716	414.00	496.80
Sorrento 100cm ceramic top	83.0020	142.00	170.40
Sorrento 70cm mirror *	1.419	118.00	141.60
Sorrento 80cm cornice **	1.522	185.00	222.00
Sorrento 800mm 'Wave' action infra red cornice **	1.219	234.00	280.80

*Mirror must be fitted with a cornice. ** During the life of this brochure lights may change to LED.

FEATURES

- Separate shaver socket

83.0020

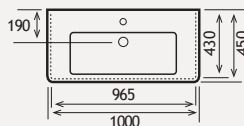

1.419

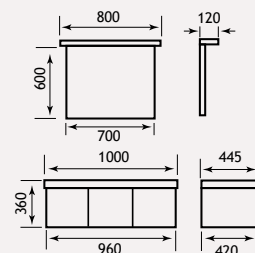

1.716

SHERWOOD CLASSIC VANITY UNITS



Sherwood Classic vanity unit in high gloss white with Sorrento 600 ceramic top. Tap and basin extra.



Sherwood Classic vanity unit in beech with inset basin. Tap extra, basin for illustration purposes only.

Sherwood Classic Vanity Units (All Flat Packed)

Description	Code	£ Ex VAT	£ Inc VAT
New classic 600 vanity unit - White Ash	34.0115	272.00	326.40
New classic 600 vanity unit - Beech	34.0117	272.00	326.40
New classic 600 vanity unit - High Gloss White	34.0118	298.00	357.60

Price includes laminate top for inset basin use.
Ceramic top is available at extra cost - see below

FEATURES

- British manufactured
- FSC - All materials sourced from protected forests
- MDF

Tops To Fit

Description	Code	£ Ex VAT	£ Inc VAT
Sorrento 60cm Ceramic top	26.0089	96.00	115.20
Osanna inset basin 500x370	51.028	105.00	126.00
Natura sit on basin 500x400	51.030	147.00	176.40
Pricilla sit on basin 510x300	51.031	147.00	176.40
Rondo sit on basin 412	51.032	147.00	176.40
Pat inset basin basin 500x369	51.034	105.00	126.00

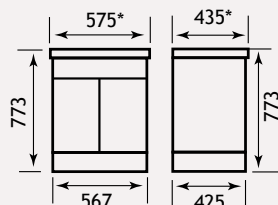

*Note: If ceramic top is used the top measurement is 600mm wide x 460mm deep x 830mm high

SHERWOOD ULTRA VANITY UNITS

Sherwood Ultra vanity unit in high gloss white with inset basin. Tap and basin extra.



Sherwood Ultra Vanity Units (All Flat Packed)

Description	Code	£ Ex VAT	£ Inc VAT
Ultra 600 vanity unit - White Ash	34.0105	272.00	326.40
Ultra 600 vanity unit - Marine Oak†	34.01009†	272.00	326.40
Ultra 600 vanity unit - Drift Wood†	34.01008†	272.00	326.40

†While stocks last

Price includes laminate top for inset basin use.
Ceramic top is available at extra cost - see below.

FEATURES

- British manufactured
- FSC - All materials sourced from protected forests
- MDF

Tops To Fit

Description	Code	£ Ex VAT	£ Inc VAT
Sorrento 60cm Ceramic top	26.0089	96.00	115.20
Osanna inset basin 500x370	51.028	105.00	126.00
Natura sit on basin 500x400	51.030	147.00	176.40
Pricilla sit on basin 510x300	51.031	147.00	176.40
Rondo sit on basin 412	51.032	147.00	176.40
Pat inset basin basin 500x369	51.034	105.00	126.00

Bath Panels

SHERWOOD BATH PANELS

A comprehensive quality range of wood effect bath panels, seats and vanity units. The latest vinyl wrapped technology is used to produce an extremely tough panel with colour matching guaranteed throughout the co-ordinated products. Universal 18mm seats are available to complement, complete with a high quality bar hinge, or the new soft close hinges.

Sherwood is produced in four designs:



All items are vinyl-wrapped MDF. Refer to style pages for finish availability. Colours subject to the limitations of the printing process. Colour sample available on request.

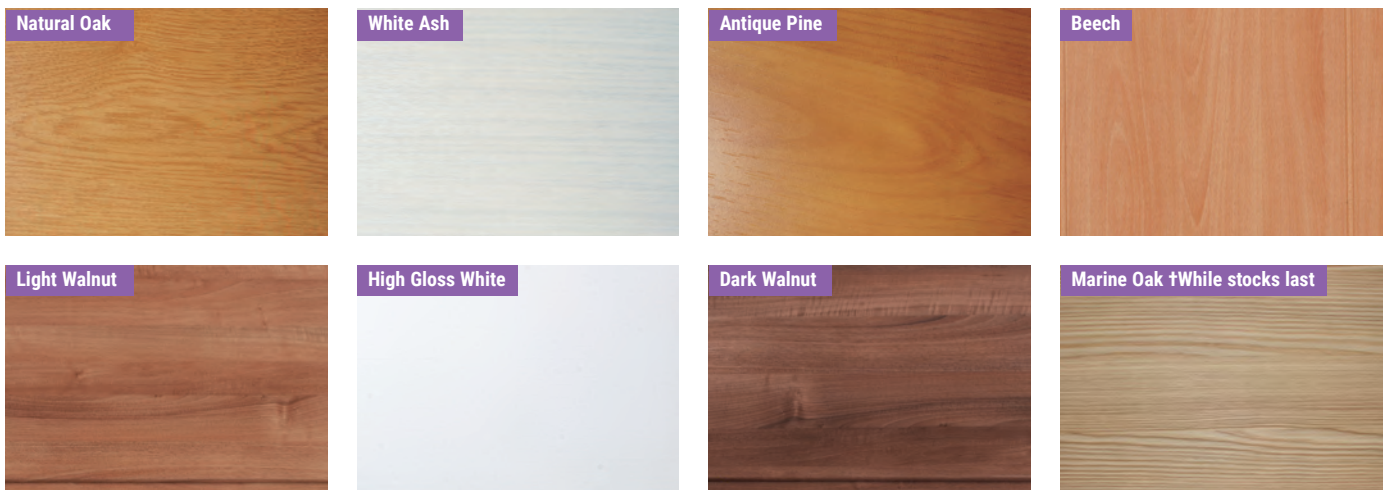

SHERWOOD ORIGINAL BATH PANELS



FEATURES

- British manufactured
- FSC - All materials sourced from protected forests
- MDF
- Fully adjustable plinth

End panel



Sherwood Original Front Bath Panels				
Description	Colour	White Ash	£ Ex VAT	£ Inc VAT
Sherwood original 1500 front bath panel	White Ash	34.0035	84.00	100.80
Sherwood original 1600 front bath panel	White Ash	34.0095	84.00	100.80
Sherwood original 1700 front bath panel	Natural Oak	34.0043	84.00	100.80
Sherwood original 1700 front bath panel	White Ash	34.0045	84.00	100.80
Sherwood original 1700 front bath panel	Antique Pine	34.0046	84.00	100.80
Sherwood original 1800 front bath panel	Natural Oak	34.0053	91.00	109.20
Sherwood original 1800 front bath panel	White Ash	34.0055	91.00	109.20
Sherwood original 1800 front bath panel	Antique Pine	34.0056	91.00	109.20

Sherwood Original End Bath Panels				
Description	Colour	White Ash	£ Ex VAT	£ Inc VAT
Sherwood original 800 end bath panel	Natural Oak	34.0083	60.00	72.00
Sherwood original 800 end bath panel	White Ash	34.0085	60.00	72.00
Sherwood original 800 end bath panel	Antique Pine	34.0086	60.00	72.00

NB. All panels include extra deep plinth, allowing panel to be adjustable from 450mm to 575mm. The 800 mm universal end panel can be cut down to 700mm or 750mm size without loss of pattern.

Extra deep plinth allows panel to be adjustable in height from 450 to 575mm. Thickness 15mm. Plinth height 150mm.

Bath Panels

SHERWOOD DIAMANTE BATH PANELS

High Gloss White



Dark Walnut

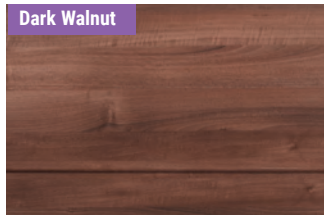

Natural Oak



High Gloss Black

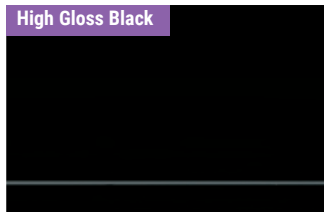

NB. 700/750 panels can be obtained by cutting down the 800 panels. All 2-piece adjustable from 450 to 575mm. Thickness 15mm. Plinth 150mm.

Colours subject to the limitations of the printing process. Colour sample available on request.



Sherwood Diamante Front Bath Panels

Description	Colour	Code	£ Ex VAT	£ Inc VAT
Diamante 1700 front panel	High Gloss Black	34.07001	116.00	139.20
Diamante 1700 front panel	High Gloss White	34.0701	116.00	139.20
Diamante 1700 front panel	Light Walnut	34.01604	84.00	100.80
Diamante 1700 front panel	Dark Walnut	34.01605	84.00	100.80
Diamante 1800 front panel	High Gloss Black	34.07101	128.00	153.60
Diamante 1800 front panel	High Gloss White	34.0711	128.00	153.60
Diamante 1800 front panel	Light Walnut	34.01704	93.00	111.60
Diamante 1800 front panel	Dark Walnut	34.01705	93.00	111.60

Sherwood Diamante End Bath Panels

Description	Colour	Code	£ Ex VAT	£ Inc VAT
Diamante 800 end panel	High Gloss Black	34.07301	91.00	109.20
Diamante 800 end panel	High Gloss White	34.0731	91.00	109.20
Diamante 800 end panel	Light Walnut	34.01904	59.00	70.80

SHERWOOD CLASSIC BATH PANELS

High Gloss White



Beech



White Ash



Panel Detail



NB. All panels include extra deep plinth adjustable in height from 450mm to 575mm. The 800 universal end panel can be cut down to 700mm or 750mm size.

End Panel



Sherwood Classic Front Bath Panels

Description	Colour	Code	£ Ex VAT	£ Inc VAT
Sherwood classic 1700 front panel	White Ash	34.1045	84.00	100.80
Sherwood classic 1700 front panel	Beech	34.1047	84.00	100.80
Sherwood classic 1700 front panel	High Gloss White	34.1048	109.00	130.80
Sherwood classic 1800 front panel	White Ash	34.1055	91.00	109.20
Sherwood classic 1800 front panel	Beech	34.1057	91.00	109.20
Sherwood classic 1800 front panel	High Gloss White	34.1058	121.00	145.20

Sherwood Classic End Bath Panels

Description	Colour	Code	£ Ex VAT	£ Inc VAT
Sherwood classic 800 end panel	White Ash	34.1085	59.00	70.80
Sherwood classic 800 end panel	Beech	34.1087	59.00	70.80
Sherwood classic 800 end panel	High Gloss White	34.1088	84.00	100.80

SHERWOOD ULTRA BATH PANELS

High Gloss White

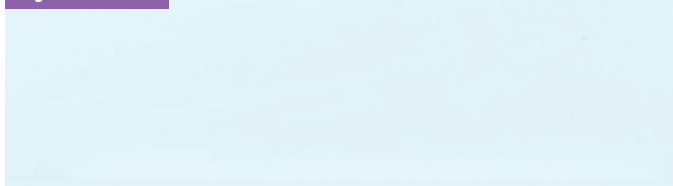

White Ash

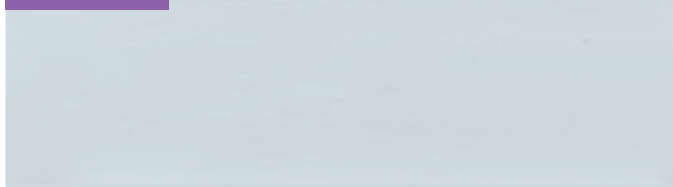

Sherwood Ultra Front Bath Panels

Description	Colour	Code	£ Ex VAT	£ Inc VAT
Ultra 1700 Panel	White Ash	34.0065	84.00	100.80
Ultra 1700 Panel	High Gloss White	34.0068	109.00	130.80
Ultra 1800 Panel	White Ash	34.0135	91.00	109.20
Ultra 1800 Panel	High Gloss White	34.0138	121.00	145.20

Sherwood Ultra End Bath Panels

Description	Colour	Code	£ Ex VAT	£ Inc VAT
Ultra 800 Panel	White Ash	34.0075	59.00	70.80
Ultra 800 Panel	High Gloss White	34.0078	84.00	100.80

Extra deep plinth allows panel to be adjustable in height from 5mm. Thickness 15mm. Plinth height 150mm.

FEATURES

- British manufactured
- FSC - All materials sourced from protected forests
- MDF
- Fully adjustable plinth

Bath Panels

DIAMANTE BATH PANELS

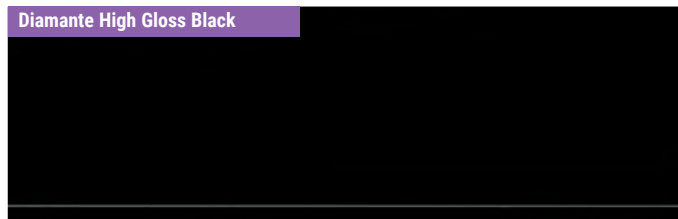
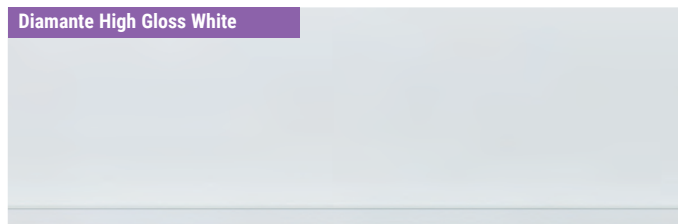

High gloss MDF panels to match Madrid, Bonito and Diamante

Diamante Bath Panels

Description	Colour	Code	£ Ex VAT	£ Inc VAT
Diamante 1700 front panel	White	34.0701	116.00	139.20
Diamante 1700 front panel	High Gloss Black	34.07001	116.00	139.20
Diamante 1800 front panel	White	34.0711	128.00	153.60
Diamante 1800 front panel	High Gloss Black	34.07101	128.00	153.60
Diamante 800 end panel	White	34.0731	91.00	109.20
Diamante 800 end panel	High Gloss Black	34.07301	91.00	109.20

NB. 700/750 panels can be obtained by cutting down the 800 panels.
All 2-piece adjustable from 450 to 575 mm. Thickness 15mm. Plinth 150mm.

FEATURES

- British manufactured
- FSC - All materials sourced from protected forests
- MDF
- Fully adjustable plinth

BONITO PANELS

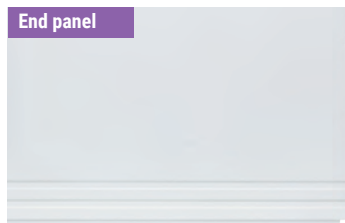
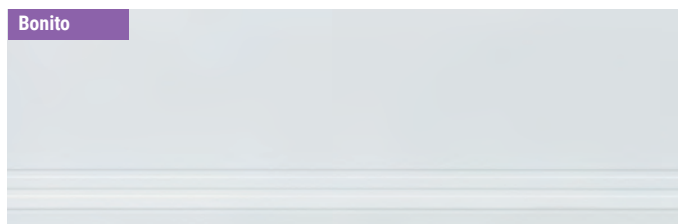

High gloss MDF panels to match Madrid, Bonito and Diamante

Bonito Panels

Description	Colour	Code	£ Ex VAT	£ Inc VAT
Bonito/Daisy 1700 front panel	White	34.0161	109.00	130.80
Bonito/Daisy 1800 front panels	White	34.0171	121.00	145.20
Bonito/Daisy 800 end panels	White	34.0191	84.00	100.80

NB. 700/750 panels can be obtained by cutting down the 800 panels.
All 2-piece adjustable from 450 to 575 mm. Thickness 15mm. Plinth 150mm.

ACER PANELS



Acer Panels

Description	Colour	Natural oak	£ Ex VAT	£ Inc VAT
Acer 1700 front panel	Dark Walnut	29.00605	117.00	140.40
Acer 1700 front panel	Natural Oak	29.0063	117.00	140.40
Acer 1800 front panel	Dark Walnut	29.00705	123.00	147.60
Acer 1800 front panel	Natural Oak	29.0073	123.00	147.60
Acer 700 end panel	Dark Walnut	29.00805	65.00	78.00
Acer 700 end panel	Natural Oak	29.0083	65.00	78.00
Acer 750 end panel	Dark Walnut	29.00905	67.00	80.40
Acer 750 end panel	Natural Oak	29.0093	67.00	80.40
Acer 800 end panel	Dark Walnut	29.01005	69.00	82.80
Acer 800 end panel	Natural Oak	29.0103	69.00	82.80

NB. 700/750 panels can be obtained by cutting down the 800 panels.
All 2-piece adjustable from 450 to 575 mm. Thickness 15mm. Plinth 150mm.

WAVE PANELS



Wave Bath Panels - High Gloss White

Description	Colour	Code	£ Ex VAT	£ Inc VAT
Wave 1700 front panel	High Gloss White	29.0018	107.00	128.40
Wave 1800 front panel	High Gloss White	29.0028	115.00	138.00
Wave 700 end panel	High Gloss White	29.0038	61.00	73.20
Wave 750 end panel	High Gloss White	29.0048	63.00	75.60
Wave 800 end panel	High Gloss White	29.0058	65.00	78.00

Toilet Seats



SHERWOOD TOILET SEATS

Suitable to match all Sherwood styles of panel with an option of a soft-close hinge.

Sherwood Toilet Seats				
Description	Colour	Code	£ Ex VAT	£ Inc VAT
Sherwood MDF seat in vinyl wrap with chrome-plated bar hinges	White Ash	34.1095	66.00	79.20
Sherwood MDF seat in vinyl wrap with chrome-plated bar hinges	Light Walnut	34.10904	66.00	79.20
Sherwood MDF seat in vinyl wrap with chrome-plated bar hinges	Beech	34.1097	66.00	79.20
Sherwood MDF seat in vinyl wrap with chrome-plated bar hinges	Dark Walnut	34.10905	66.00	79.20
Sherwood MDF seat in vinyl wrap with chrome-plated bar hinges	Antique Pine	34.1096	66.00	79.20
Sherwood MDF seat in vinyl wrap with chrome-plated bar hinges	Natural Oak	34.1093	66.00	79.20
Sherwood MDF seat in vinyl wrap with chrome-plated bar hinges	High Gloss White	34.1098	78.00	93.60
Sherwood MDF seat in vinyl wrap with chrome plated soft-close hinges *	White Ash	34.0125	108.00	129.60
Sherwood MDF seat in vinyl wrap with chrome plated soft-close hinges *	Light Walnut	34.01204	108.00	129.60
Sherwood MDF seat in vinyl wrap with chrome plated soft-close hinges *	Beech	34.0127	108.00	129.60
Sherwood MDF seat in vinyl wrap with chrome plated soft-close hinges *	Dark Walnut	34.01205	108.00	129.60
Sherwood MDF seat in vinyl wrap with chrome plated soft-close hinges *	Antique Pine	34.0126	108.00	129.60
Sherwood MDF seat in vinyl wrap with chrome plated soft-close hinges *	Natural Oak	34.0123	108.00	129.60
Sherwood MDF seat in vinyl wrap with chrome plated soft-close hinges *	High Gloss White	34.0128	117.00	140.40

*Not bar hinges & top fix hinge.

FEATURES

- British manufactured
- FSC - All materials sourced from protected forests
- MDF
- Soft close seat option available
- Hinge centres adjust 155-165mm

Sherwood toilet seat
440mm (from back of hinge) x 375mm at widest point, 420mm x 375mm lid size.

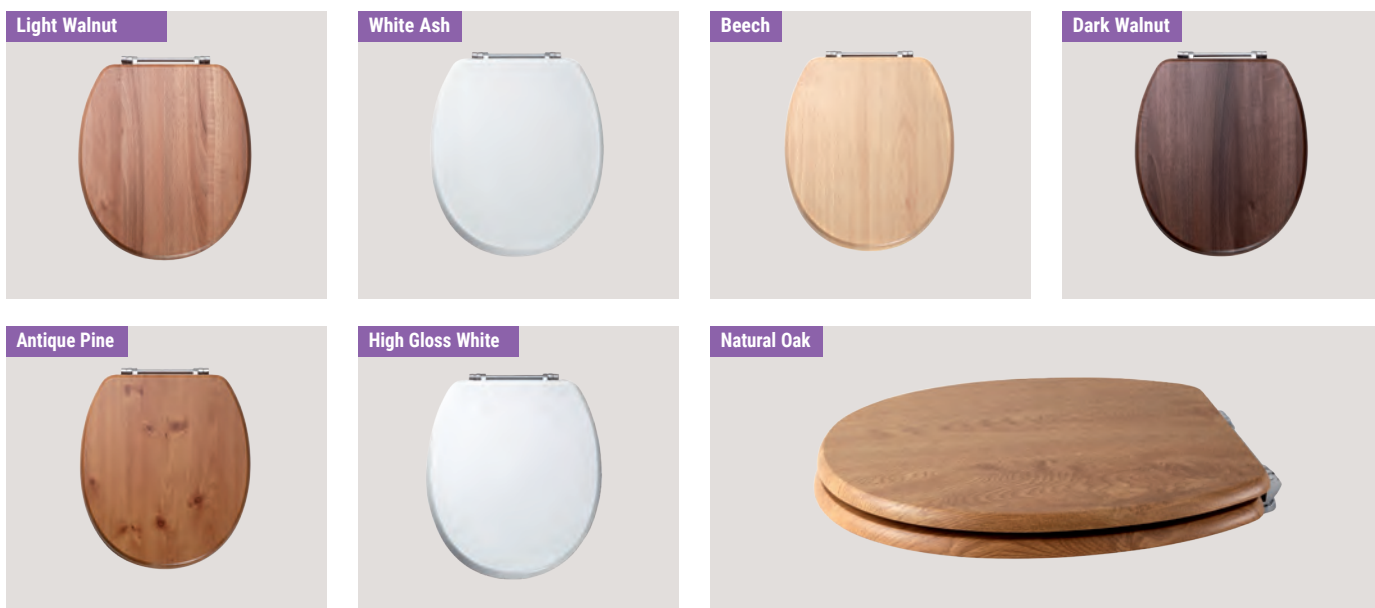

DIAMANTE TOILET SEATS

Diamante High Gloss Toilet Seat				
Description	Colour	Code	£ Ex VAT	£ Inc VAT
Sherwood seat with Chrome hinges	High Gloss White	34.1098	78.00	93.60
Sherwood seat soft close hinge*	High Gloss White	34.0128	117.00	140.40
Sherwood seat with Chrome hinges	High Gloss Black	34.10901	78.00	93.60
Sherwood seat soft close hinge*	High Gloss Black	34.01201	117.00	140.40

NB. Soft close hinges are standard not bar type.*Top fix hinge.

FEATURES

- Soft close seat option available



Colours subject to the limitations of the printing process.
Colour sample available on request.



Mirrors & Cabinets

Cabinet mirrors, mirrors with lights, plain mirrors, featuring lots of exciting designs from art deco minimalist to the more traditional approach.

Contents	
Plain mirrors	390 - 391
Vanity mirrors	392
Mirrored cabinets	393 - 401
Mirrored corner cabinets	402
Mirrors with cornice	403 - 405
Mirrors with LED	405 - 412
Mirrors with florescent light	413

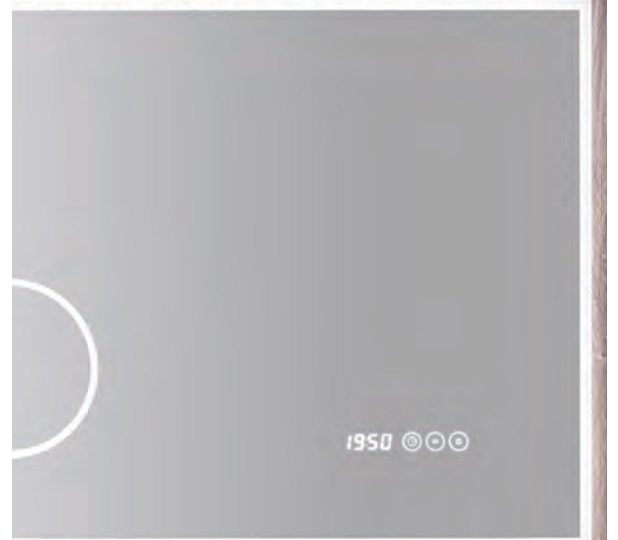

Plain Mirrors

BRUNSWICK



Brunswick			
Description (height x width)	Code	£ Ex VAT	£ Inc VAT
Brunswick bathroom mirror 700 x 500 with shelf	40.0019	54.00	64.80

FEATURES

- Complete with glass shelf
- Clean and simple design, that works in a modern or traditional setting.
- Bevelled edge

SAVANNAH



Bevelled edge

Savannah			
Description (height x width)	Code	£ Ex VAT	£ Inc VAT
Savannah Mirror 750 x 550 with Shelf	40.0018	54.00	64.80

FEATURES

- Complete with glass shelf
- Bevelled edge
- Tempered glass

SEATTLE



Seattle			
Description (height x width)	Code	£ Ex VAT	£ Inc VAT
Seattle 500 x 700mm two-layer mirror	56.1018	102.00	122.40

FEATURES

- Tempered glass

VANCOUVER



Vancouver			
Description (height x width)	Code	£ Ex VAT	£ Inc VAT
Vancouver 500 x 700mm two-layer mirror †	56.1017	108.00	129.60

NB Mirror mounted on clear glass mount with chrome border

†While stocks last

Plain Mirrors

PLAIN MIRROR



Pictured 40.0020



Pictured 40.0021



Bevelled edge

Plain Mirror

Description (height x width)

Plain Mirror 555 x 1000

Plain Mirror 555 x 810mm

Code	£ Ex VAT	£ Inc VAT
40.0020	66.00	79.20
40.0021	63.00	75.60

FEATURES

- Mounted horizontally or vertically
- Bevelled edge

Vanity Mirrors

ROUND LED VANITY MIRROR

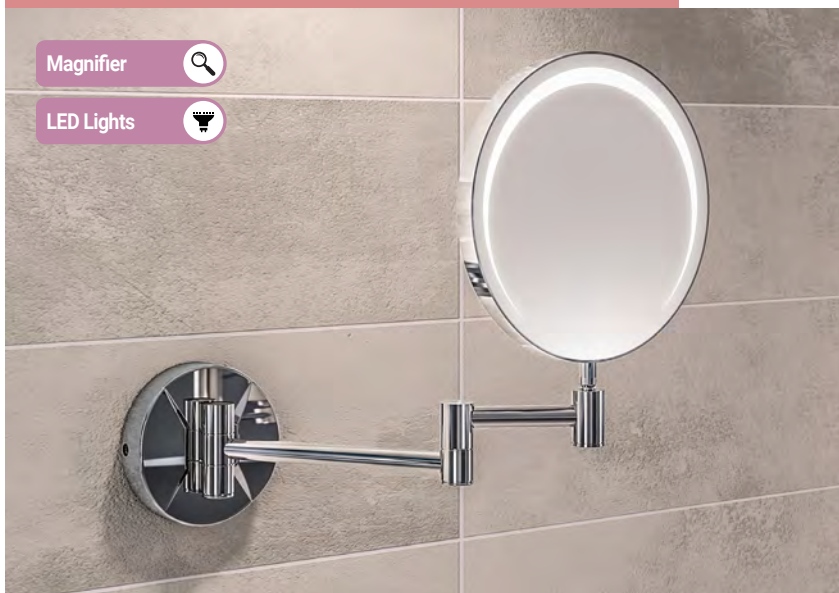

Round LED Vanity Mirror

Description	Code	£ Ex VAT	£ Inc VAT
Round LED vanity mirror	40.0039	231.00	277.20

FEATURES

- Double sided mirror, 5x magnification
- LED lights
- Double swing arm
- IP 44

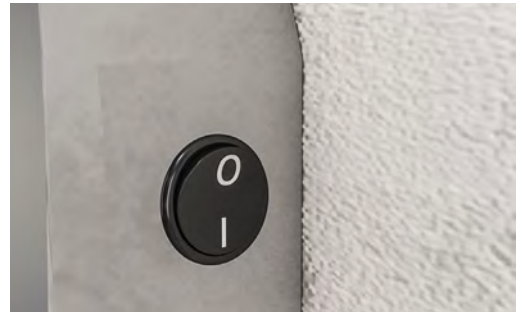

SQUARE LED VANITY MIRROR



Square LED Vanity Mirror

Description	Code	£ Ex VAT	£ Inc VAT
Square LED vanity mirror	40.0040	165.00	198.00

FEATURES

- Double sided mirror, 5x magnification
- LED lights
- Double swing arm
- IP 44

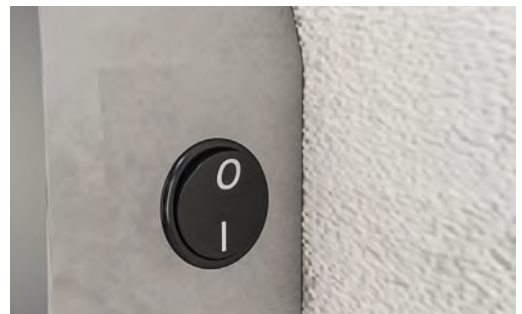

ROUND FROSTED LED VANITY MIRROR



Round Frosted LED Vanity Mirror

Description	Code	£ Ex VAT	£ Inc VAT
Round Frosted LED vanity mirror	40.0041	159.00	190.80

FEATURES

- 5x magnification
- LED lights
- Double swing arm
- IP 44

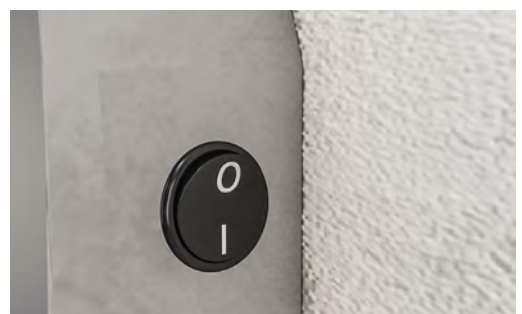

Cabinet Mirrors

CABINET MIRROR

Cabinet Mirror

Description (width x depth x height)	Code	£ Ex VAT	£ Inc VAT
Cabinet mirror 460 x 120 x 660	56.1001	128.00	153.60
Cabinet mirror 250 x 120 x 660	56.1002	95.00	114.00

FEATURES

- Cupboards are reversible
- Soft close doors
- Modular versatile system

*800mm wide when fully opened - 56.1001
 *430mm wide when fully opened - 56.1002

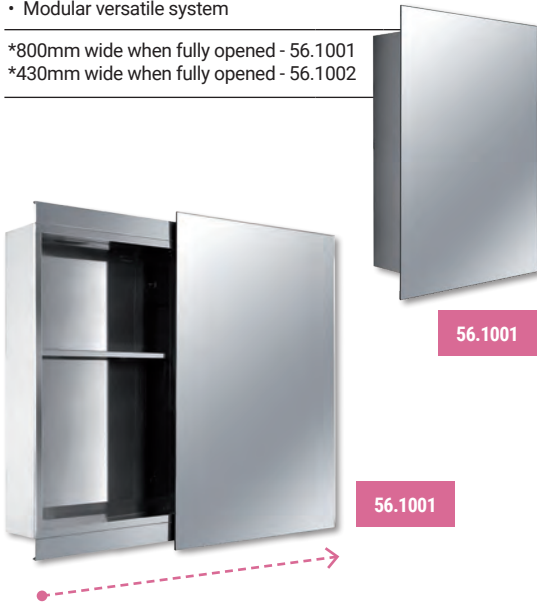

56.1001

56.1001

800mm when fully opened,
only opens as illustrated



BOSINI

Bosini

Description (width x height x depth)	Code	£ Ex VAT	£ Inc VAT
Bosini 600 x 700 x 120 2 Door Mirror Cabinet	40.0024	247.00	296.40
Bosini 800 x 600 x 120 2 Door Mirror Cabinet	40.0025	285.00	342.00

FEATURES

- Internal mirror on door
- Can be recessed into the wall.
- Soft close hinges
- Adjustable shelving



Wall recessed
40.0025

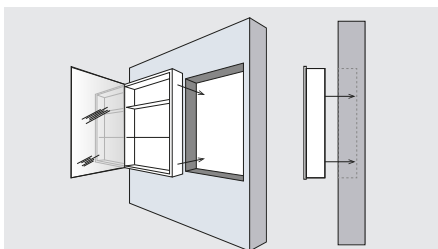

Cabinet Mirrors

CALDINI 2 DOOR CABINET



Demister



LED Lights



Shaver Socket



Caldini - 2 Door Cabinet

Description (width x height x depth)	Code	£ Ex VAT	£ Inc VAT
Caldini 600 x 700 x 130 LED 2 Door Cabinet Mirror	40.0029	508.00	609.60
Caldini 800 x 700 x 130 LED 2 Door Mirror Cabinet	40.0030	540.00	648.00

FEATURES

- Internal mirror on door
- Aluminium frame
- Infinitely variable shelf heights
- Demister
- Shaver socket
- LED lights on the inside, outside and underside of the cabinet
- Soft close hinges

Cabinet is IP54.



CALDINI 1 DOOR CABINET



Demister



LED Lights



Shaver Socket



Caldini - 1 Door Cabinet

Description (width x height x depth)	Code	£ Ex VAT	£ Inc VAT
Caldini 350 x 450 x 130 LED 1 Door Mirror Cabinet	40.0026	302.00	362.40
Caldini 400 x 600 x 130 LED 1 Door Mirror Cabinet	40.0027	360.00	432.00
Caldini 500 x 700 x 130 LED 1 Door Mirror Cabinet	40.0028	406.00	487.20

FEATURES

- Internal mirror on the door
- Aluminium frame
- Infinitely variable shelf heights
- Demister
- Shaver socket
- LED lights on the inside, outside and underside of the cabinet
- Softclose hinges

Cabinet is IP54.



Cabinet Mirrors

CABINET WITH CORNICES



800mm mirror cabinet with a choice of two cornices – a light cornice or a shaver socket cornice. Both come with two lamps.

Cabinet - 1.401			
Description	Code	£ Ex VAT	£ Inc VAT
80cm cabinet mirror (no cornice)	1.401	177.00	212.40
80cm light cabinet cornice, 2 spots	1.403	126.00	151.20
80cm light shaver skt cabinet cornice	1.404	185.00	222.00

Cabinet - 1.405			
Description	Code	£ Ex VAT	£ Inc VAT
100cm cabinet mirror (no cornice)	1.405	219.00	262.80
100cm light cabinet cornice, 2 spots	1.407	140.00	168.00
100cm light shaver skt cabinet cornice	1.408	195.00	234.00

All cornices are sold separately from the mirror cabinets.
All cornices are IP54



Basin for photography purposes only

Cabinet 80cm

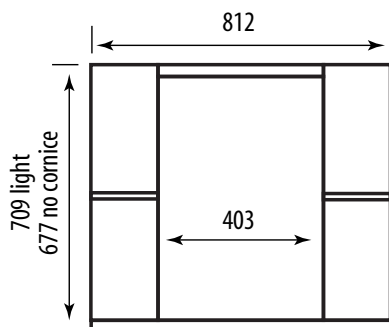

Cabinet 100cm

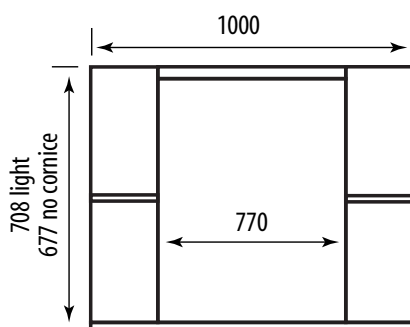

1000mm mirror cabinet with a choice of two cornices - a light cornice or a socket cornice. Both come with two halogen lamps.* Cornices are sold separately. ** During the lifetime of this brochure lights may change to LED.



Basin for photography purposes only

Cabinet Mirrors

CABINET WITH CORNICES



600mm mirror cabinet with a choice of two cornices - a light cornice or a shaver socket cornice. Both come with a single halogen lamp. Cornices are sold separately.

Cabinet - 1.094			
Description	Code	£ Ex VAT	£ Inc VAT
60cm cabinet mirror (no cornice)	1.094	160.00	192.00
60cm light cabinet cornice, 1 spot	1.096	94.00	112.80
60cm light shaver skt cabinet cornice**	1.097	158.00	189.60

430mm mirror cabinet with a light cornice (one halogen lamp with pull cord operation). The cornice is sold separately from the cabinet. Door is not reversible.

Cabinet - 1.090			
Description	Code	£ Ex VAT	£ Inc VAT
43cm cabinet mirror (no cornice)	1.090	141.00	169.20
43cm light cabinet cornice, 1 spot	1.093	79.00	94.80

All cornices are IP54. **During the life of this catalogue lights may change to LED.

Cabinet 80cm Cabinet 43cm

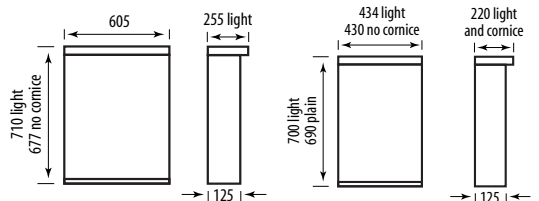

* Basin for photography purposes only

PLAIN CABINETS



LED Lights

Modest, versatile cabinets available with LED lighting and mirrors in various sizes to suit most bathrooms. Pull cord for LED lighting located inside the cabinet.

Plain Cabinets (Single Knob)			
Description (width x height x depth)	Code	£ Ex VAT	£ Inc VAT
400 x 400 x 180mm Cabinet	56.1038	86.00	103.20
400 x 400 x 180mm Cabinet with LED	56.1039	105.00	126.00
400 x 800 x 180mm Cabinet	56.1040	131.00	157.20
400 x 800 x 180mm Cabinet with LED	56.1041	152.00	182.40

FEATURES

- Modular versatile system
- Available with a light option
- Soft close doors

Mirror with LED IP54.

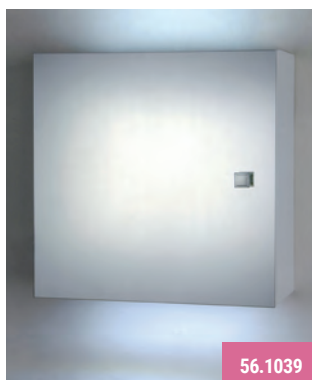

Cabinet Mirrors

BONITO 120

Bonito 120			
Description	Code	£ Ex VAT	£ Inc VAT
Bonito 60cm wall unit - door	1.034	179.00	214.80
Bonito 60cm mirror	1.036	103.00	123.60
Diamante 60cm Cornice	1.204	158.00	189.60

NB: Mirror must be fitted with cornice. Cornice is IP54. *During the life of this catalogue lights may change to LED.

FEATURES

- Shaver socket
- 60 cm cornice has two LED lamps*
- Slimline, just 120mm projection

Width: 600mm. Height: 706mm.

N.B. Cornice sold separately

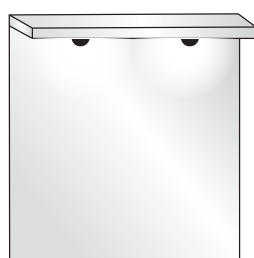

Mirror & Cornice with halogen and pull-cord operational

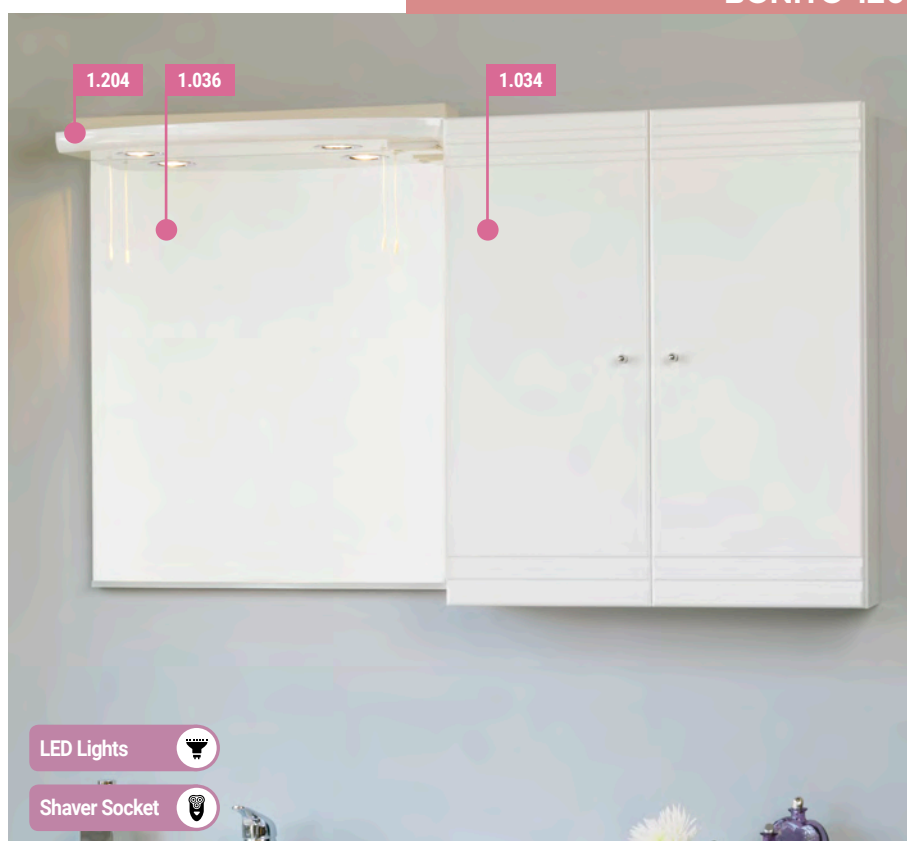

The 60cm cornice has two halogen lamps and a shaver socket.**

Diamante 110			
Description (width x height x depth)	Code	£ Ex VAT	£ Inc VAT
Diamante 50cm wall unit	1.254	179.00	214.80
Bonito 60cm mirror	1.036	103.00	123.60
Diamante 60cm Cornice	1.204	158.00	189.60

FEATURES

- Slimline, just 120mm projection
- Shaver socket
- Wall unit - 2 shelves

NB: Mirror must be fitted with cornice. Cornice is IP54. **During the life of this catalogue lights may change to LED.

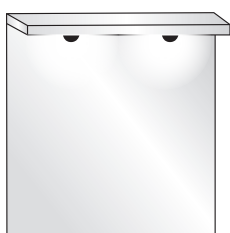

MIRROR & CORNICE WITH LED LIGHTS AND PULL-CORD OPERATION

Width: 600mm
Height: 706mm

N.B. Cornice sold separately

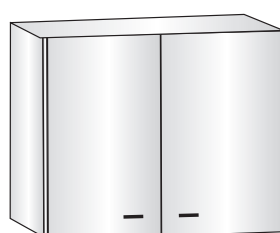

500MM WALL CUPBOARD WITH TWO DOORS

Width: 500mm
Depth: 176mm
Height: 700mm

DIAMANTE 110



Cabinet Mirrors

GENEVA



Geneva			
Description (width x height x depth)	Code	£ Ex VAT	£ Inc VAT
Geneva 300x490x105 SS cabinet with mirror†	56.1051	128.00	153.60

FEATURES

- Stainless steel

†While stocks last

LUCERNE



Lucerne			
Description (width x height x depth)	Code	£ Ex VAT	£ Inc VAT
Lucerne 700x500x170 Mirrored cabinet	56.1048	446.00	535.20

FEATURES

- Sensor on/off
- Two LED lights

Cabinet is IP54.

Touch Sensor 

LED Lights 

Cabinet Mirrors

MIRROR CABINET

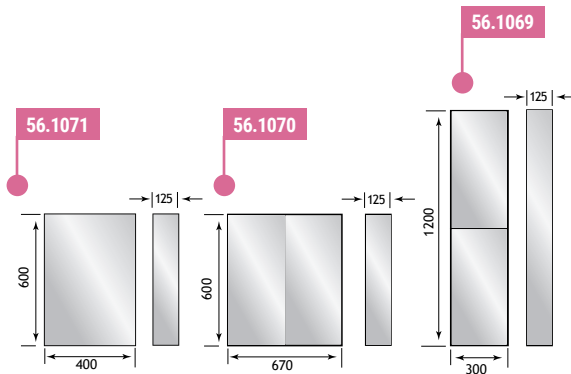

Mirror Cabinet			
Description	Code	£ Ex VAT	£ Inc VAT
Mirror cabinet 1200x300x125 [†]	56.1069	242.00	290.40
Mirror cabinet 670x600x125 [†]	56.1070	201.00	241.20
Mirror cabinet 400x600x125 [†]	56.1071	146.00	175.20

FEATURES

- Adjustable glass shelves
- Stainless steel clad carcass
- Mirror doors

Cabinet is IP54. [†]While stocks last



SINGLE KNOB MIRROR CABINET

Mirror Cabinet			
Description (width x height x depth)	Code	£ Ex VAT	£ Inc VAT
400 x 400 x 180mm Mirror Cabinet [†]	56.1042	93.00	111.60
400 x 800 x 180mm Mirror Cabinet [†]	56.1044	149.00	178.80

Mirror with LED IP54. [†]While stocks last

Plain Cabinets			
Description (width x height x depth)	Code	£ Ex VAT	£ Inc VAT
400 x 400 x 180mm Cabinet with LED	56.1039	105.00	126.00
400 x 800 x 180mm Cabinet with LED	56.1041	152.00	182.40

Mirror with LED IP54.



LED Lights



Cabinet Mirrors

OSLO



These versatile, modular wall cupboards are ideal for family needs giving everyone their own storage space. The cupboards are reversible, feature soft close doors and can be used in any combination.

Oslo			
Description	Code	£ Ex VAT	£ Inc VAT
Oslo square 400mm wall cupboard	1.263	139.00	166.80
Oslo square 400mm mirror wall cupboard	1.264	146.00	175.20

FEATURES

- Cupboards are reversible
- Soft close doors
- Modular versatile system
- 1 Shelf

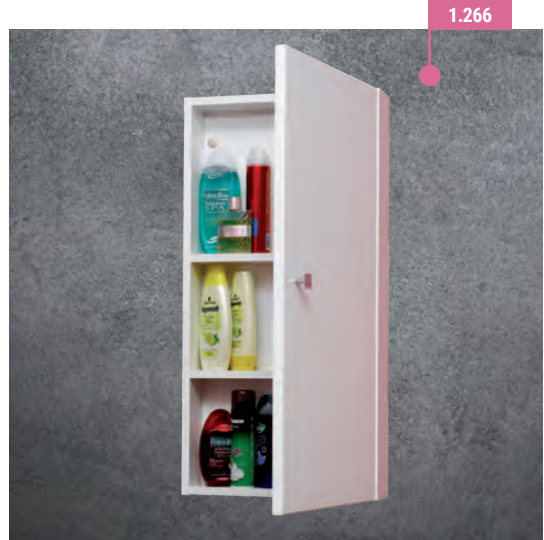

Description	Code	£ Ex VAT	£ Inc VAT
Oslo wall cupboard 400 x 800mm	1.265	177.00	212.40
Oslo wall cupboard 400 x 1000mm	1.266	192.00	230.40

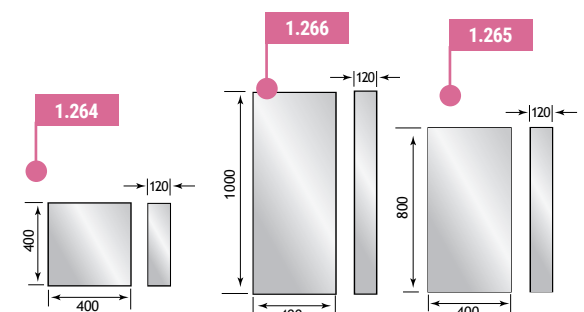

Cabinet Mirrors

RAVINI

Ravini			
Description (width x height x depth)	Code	£ Ex VAT	£ Inc VAT
Ravini 400 x 600 x 120 1 Door Mirror Cabinet	40.0022	183.00	219.60
Ravini 500 x 700 x 120 1 Door Mirror Cabinet	40.0023	195.00	234.00

FEATURES

- Internal mirror on door
- Can be recessed into the wall
- Soft close hinges
- Adjustable shelving

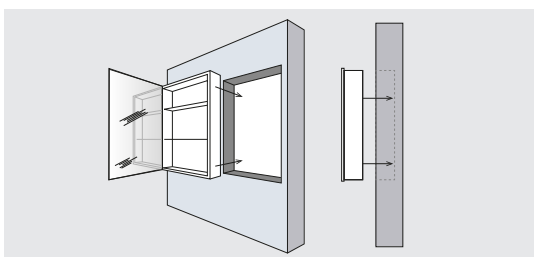

Alternatively the Ravini be installed outside of the wall

ZURICH



Shaver Socket



Zurich

Description (width x height x depth)	Code	£ Ex VAT	£ Inc VAT
Zurich 500x700x140 Mirrored cabinet	56.1047	446.00	535.20

FEATURES

- Two light sensors
- Internal shaver socket
- Soft close door
- Digital clock

Cabinet is IP54.

Corner Cabinet Mirrors

BONITO CORNER UNIT



Bonito corner mirror 1.088
(Mirror only, not cabinet)

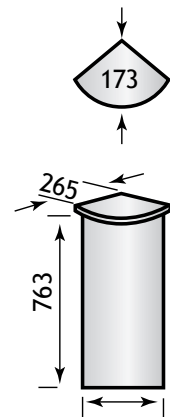

Corner cupboard light cornice 1-002

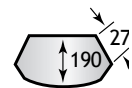

Corner mirror cupboard 1-000

Bonito

Description	Code	£ Ex VAT	£ Inc VAT
Corner mirror cupboard carcass	1.000	183.00	219.60
Corner cupboard light cornice	1.002	70.00	84.00
Bonito Corner mirror with light	1.088	139.00	166.80

NB: Cornice is IP54. *During the life of this catalogue lights may change to LED.

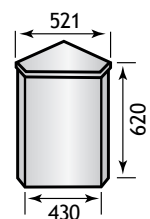

Madrid Mirrors



Unit 1.105 has 2 shelves inside



Madrid			
Description	Code	£ Ex VAT	£ Inc VAT
43cm mirror 1 light	1.086	174.00	208.80
Madrid 20cm wall unit	1.015	103.00	123.60
Diamante/Madrid 20cm single shelf	1.217	65.00	78.00
Diamante 60cm mirror	1.203	103.00	123.60
Diamante 60cm Cornice*	1.204	158.00	189.60
Diamante 80cm mirror	1.208	119.00	142.80
Diamante 80cm Cornice*	1.209	194.00	232.80
Diamante 100cm mirror	1.213	133.00	159.60
Diamante 100cm Cornice*	1.214	207.00	248.40

NB: Mirror must be fitted with cornice. All cornices are IP54.
*During the life of this catalogue lights may change to LED.

Sorrento Mirrors



Sorrento			
Description	Code	£ Ex VAT	£ Inc VAT
Sorrento 40cm mirror	1.418	87.00	104.40
Sorrento 45cm cornice*	1.520	136.00	163.20
Sorrento 60cm cornice*	1.521	156.00	187.20
Sorrento 70cm mirror	1.419	118.00	141.60
Sorrento 80cm cornice*	1.522	185.00	222.00
Sorrento 800mm 'Wave' action infra red cornice	1.219	234.00	280.80

FEATURES

- Separate shaver socket
- 800 cornice has a sensor option

NB: Mirror must be fitted with cornice. All cornices are IP54.
*During the life of this catalogue lights may change to LED.

Cornices are now available with an option of 'Wave' action infra red technology to activate lights.



LED Mirrors

Faro			
Description	Code	£ Ex VAT	£ Inc VAT
Faro 39cm mirror	1.270	95.00	114.00
Faro 39cm cornice	1.277	136.00	163.20
Faro 58cm wave action cornice	1.272	201.00	241.20
Faro 58cm mirror	1.271	115.00	138.00
Faro 80cm mirror	1.273	133.00	159.60
Faro 80cm wave action cornice	1.274	233.00	279.60
Faro 100cm mirror	1.275	153.00	183.60
Faro 100cm wave action cornice	1.276	258.00	309.60
Faro 20cm Wall Cupboard	1.268	126.00	151.20

FEATURES

- Wave action infrared sensor (on/off)

This line needs to be doubled if two cupboards required ie £240 plus VAT. Mirror must be fitted with cornice. Cornice is IP54.
 **During the life of this catalogue lights may change to LED.



- Magnifier
- Touch Sensor
- LED Lights

BOWMONT

Bowmont			
Description (Width x height)	Code	£ Ex VAT	£ Inc VAT
Bowmont 600 x 500 LED mirror	56.1075	267.00	320.40

FEATURES

- LED lights
- On/off swipe sensor switch
- Digital clock
- Magnifier (x3 magnification)

IP54

LED Mirrors

ELLERA



Touch Sensor 

Demister 

LED Lights 

Ellera

Description (diameter x depth)	Code	£ Ex VAT	£ Inc VAT
Ellera 580 x 40 Circular LED Mirror	40.0036	180.00	216.00
Ellera 620 x 40 Circular LED Mirror	40.0037	196.00	235.20

FEATURES

- Demister
- LED lights
- Touch Sensor



ESK



Touch Sensor 

Demister 

LED Lights 

Esk

Description (width x height)	Code	£ Ex VAT	£ Inc VAT
Esk 600 x 700 LED mirror	56.1079	206.00	247.20
Esk 700 x 700 LED mirror	56.1080	235.00	282.00

FEATURES

- LED lights
- On/off touch sensor switch
- Demister pad

Mirror is IP54.

LED Mirrors

ETTRICK

Ettrick			
Description (width x height)	Code	£ Ex VAT	£ Inc VAT
Ettrick 500 x 700 LED mirror	56.1078	180.00	216.00

FEATURES

- LED lights
- On/off touch sensor switch

Mirror is IP54.



Touch Sensor 

LED Lights 

Fabriano			
Description (width x height)	Code	£ Ex VAT	£ Inc VAT
Fabriano 700 x 500mm LED Landscape Mirror	40.1004	242.00	290.40
Fabriano 500 x 700mm LED Portrait Mirror	40.1005	242.00	290.40

FEATURES

- LED lighting
- Sensor control
- Digital clock
- Magnifier (6x magnification)
- Demister

Mirror is IP54.

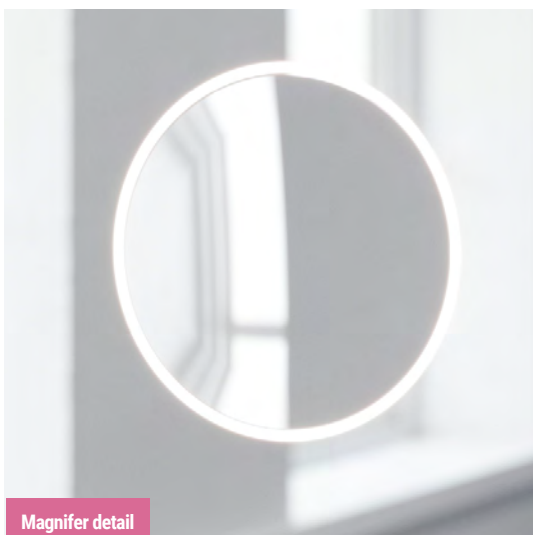



Magnifier detail

FABRIANO



Magnifier 

Touch Sensor 

Demister 

LED Lights 

LED Mirrors

FINDHORN

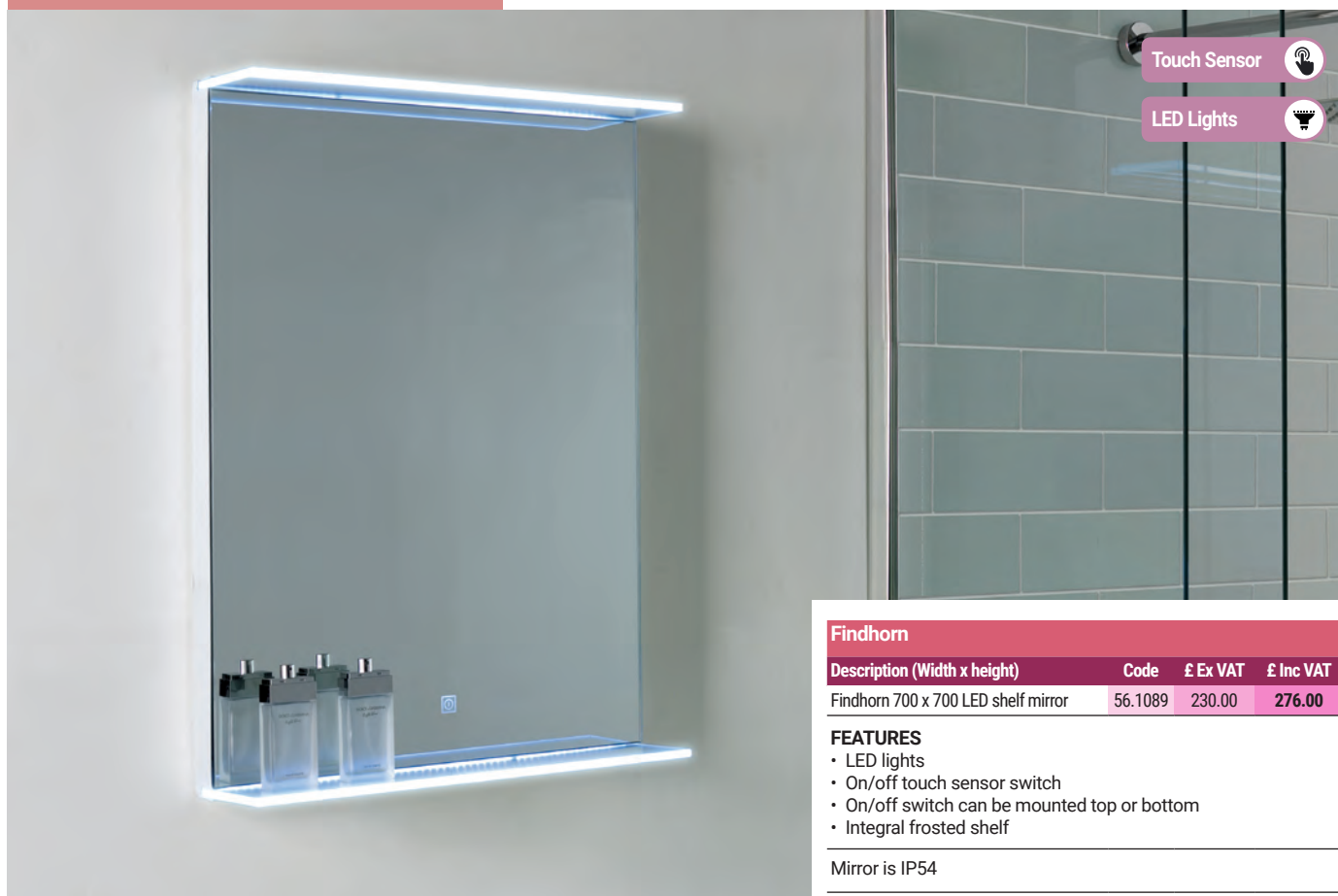

Findhorn

Description (Width x height)	Code	£ Ex VAT	£ Inc VAT
Findhorn 700 x 700 LED shelf mirror	56.1089	230.00	276.00

FEATURES

- LED lights
- On/off touch sensor switch
- On/off switch can be mounted top or bottom
- Integral frosted shelf

Mirror is IP54

KLOSTERS



Klostern

Description (width x height x depth)	Code	£ Ex VAT	£ Inc VAT
Klostern 570x700x65 LED magnifier mirror†	56.1065	328.00	393.60

FEATURES



- White LED light
- Magnifier
- Sensor on/off

Mirror is IP54. †While stocks last

LED Mirrors

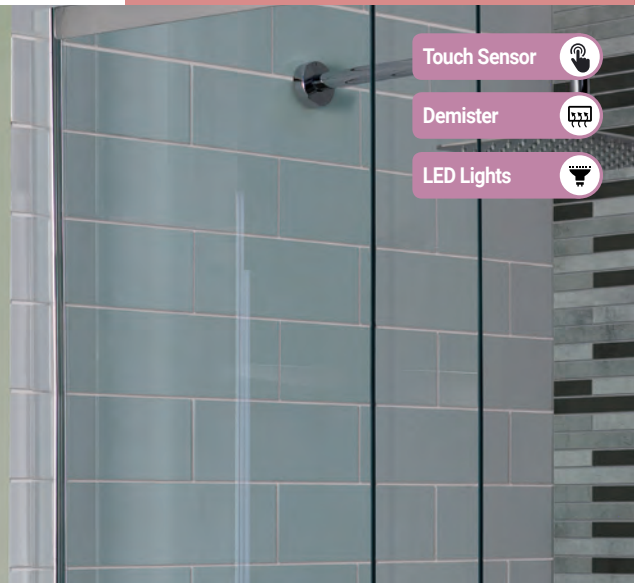
LANGTON



- Touch Sensor 
- Demister 
- LED Lights 

Langton			
Description (Width x height)	Code	£ Ex VAT	£ Inc VAT
Langton 500 x 700 illuminated mirror	56.1073	185.00	222.00
Langton 600 x 700 illuminated mirror	56.1074	192.00	230.40

FEATURES

- Light strips
- Demister pad
- On/off touch sensor switch
- Digital clock

Mirror is IP54

LEVEN

Leven			
Description (width x height x depth)	Code	£ Ex VAT	£ Inc VAT
Leven 600 x 600 bluetooth mirror	56.1081	290.00	348.00
Leven 700 x 600 bluetooth mirror	56.1082	298.00	357.60
Leven 800 x 600 bluetooth mirror	56.1083	312.00	374.40





FEATURES

- LED lights
- On/off touch sensor switch
- Demister pad
- Bluetooth enabled

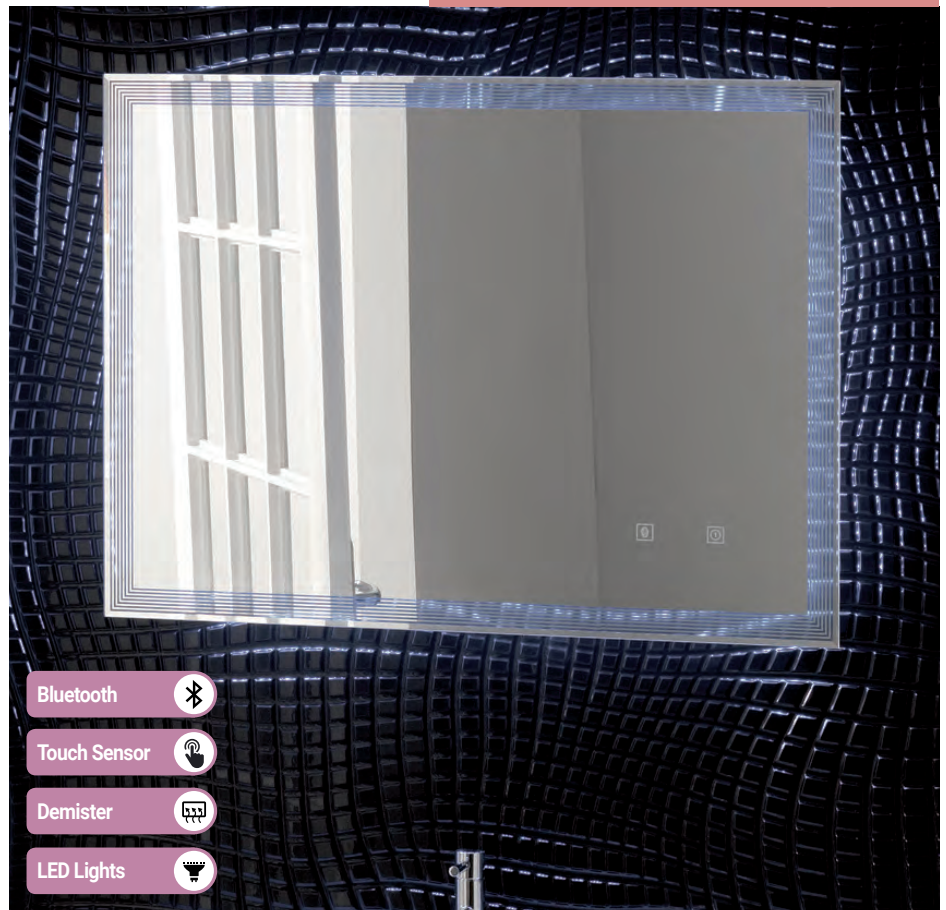
Link up your phone, tablet or computer via Bluetooth to play music through the Leven mirror!

Mirror is IP54.



- Bluetooth 
- Touch Sensor 
- Demister 
- LED Lights 

LED Mirrors

LED BATHROOM MIRROR



Touch Sensor 

Demister 

LED Lights 

LED Bathroom Mirror

Description (width x height)	Code	£ Ex VAT	£ Inc VAT
LED bathroom mirror 500 x 700	56.1004	217.00	260.40
LED bathroom mirror 600 x 700	56.1005	236.00	283.20

FEATURES

- Demister
- LED lights
- Touch sensor

Mirror is IP54.

56.1004

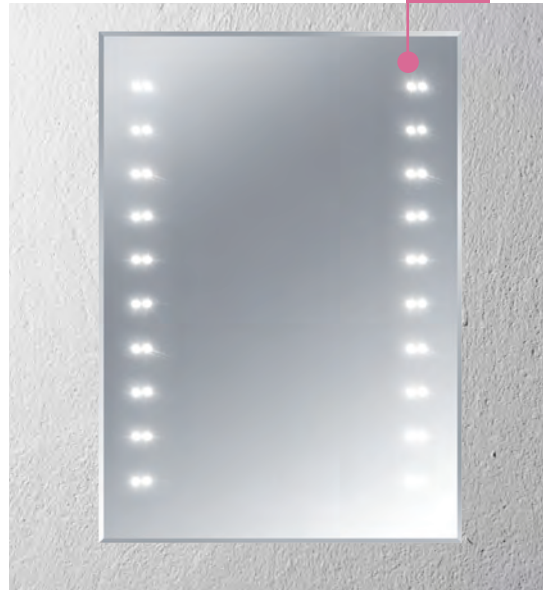

OVADA



Demister 

LED Lights 

Ovada

Description (width x height x depth)	Code	£ Ex VAT	£ Inc VAT
Ovada 500 x 700 x 45 Mirror with Light	40.0038	115.00	138.00

FEATURES

- Demister
- LED lights

Mirror is IP54.

LED Mirrors

Pegella			
Description (width x height x depth)	Code	£ Ex VAT	£ Inc VAT
Pegella 400 x 600 x 45 LED Mirror	40.0031	185.00	222.00
Pegella 500 x 700 x 45 LED Mirror	40.0032	214.00	256.80
Pegella 600 x 800 x 45 LED Mirror	40.0033	244.00	292.80
Pegella 800 x 700 x 45 LED Mirror	40.0034	259.00	310.80
Pegella 420 x 1400 x 45 LED Mirror	40.0035	329.00	394.80

FEATURES

- Demister
- LED lights
- On/off touch sensor

Mirror is IP54.

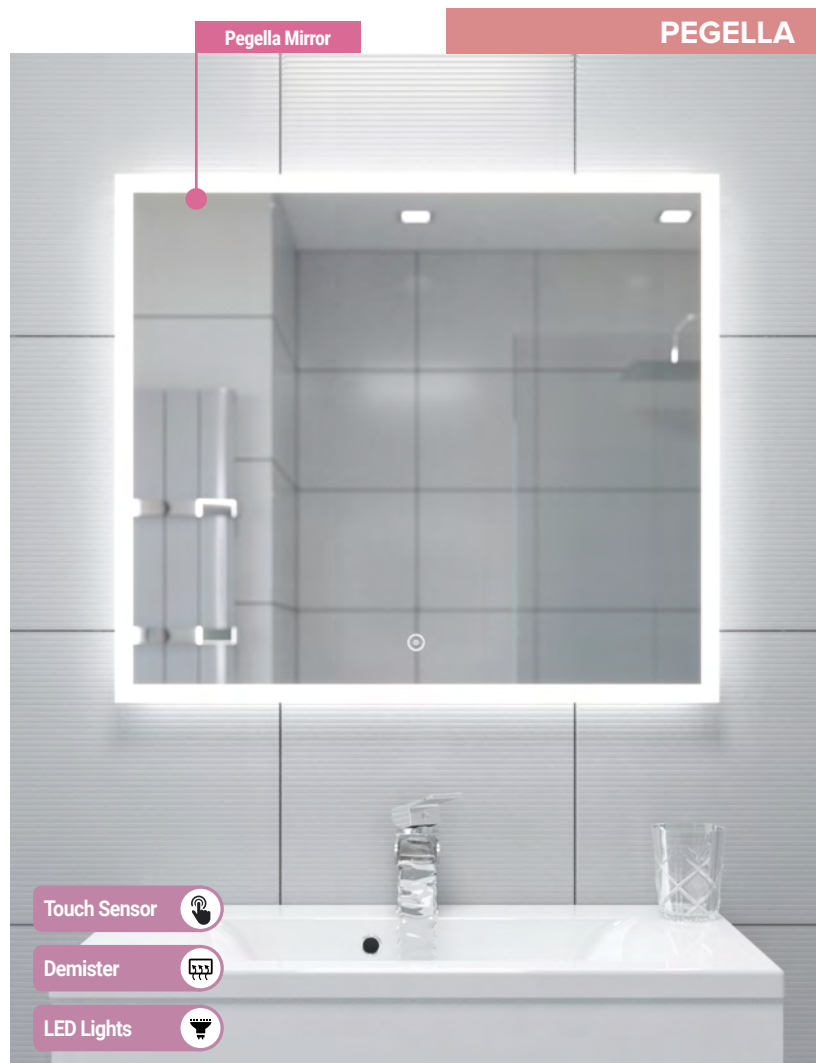

Pegella Mirror 40.0035



LED Mirrors

SPEY

Touch Sensor 

Demister 

LED Lights 



Spey

Description (width x height)	Code	£ Ex VAT	£ Inc VAT
Spey 500 x 700 LED shelf mirror	56.1084	250.00	300.00
Spey 600 x 700 LED shelf mirror	56.1085	266.00	319.20
Spey 700 x 700 LED shelf mirror	56.1086	285.00	342.00

FEATURES

- LED lights
- On/off touch sensor switch
- Digital clock
- Demister pad
- Integral shelf

You have the time, you have the light, and also a display shelf! All built-in to the Spey mirror.

Mirror is IP54.

TREVISO

Touch Sensor 

LED Lights 

40.1000 (White)



Treviso

Description (width x height x depth)	Light Colour	Code	£ Ex VAT	£ Inc VAT
Treviso 700 x 500mm LED Landscape Mirror	White	40.1000	170.00	204.00
Treviso 700 x 500mm LED Landscape Mirror	Blue	40.1001	170.00	204.00
Treviso 700 x 500mm LED Portrait Mirror	White	40.1002	170.00	204.00
Treviso 700 x 500mm LED Portrait Mirror	Blue	40.1003	170.00	204.00

FEATURES

- White or blue LED light
- Sensor control

Mirror is IP54.

40.1001 (Blue)

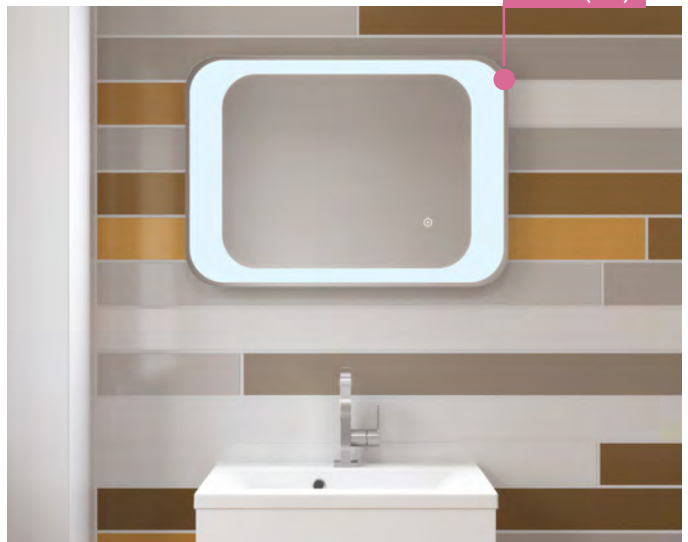

Florescent Mirrors

CHARLESTON

Charleston			
Description (width x height)	Code	£ Ex VAT	£ Inc VAT
Charleston bathroom mirror 500 x 700	66.0001	108.00	129.60
Charleston Bathroom Mirror 600 x 700	40.0014	117.00	140.40
Charleston bathroom mirror 600 x 800	66.0003	129.00	154.80

FEATURES

- Back lit
- Fluorescent tube light

Mirror is IP54.



ROCKLAND



Rockland

Description (diameter)	Code	£ Ex VAT	£ Inc VAT
Rockland circular bathroom mirror 600mm	66.0004	115.00	138.00

FEATURES

- Back lit
- Fluorescent light

Mirror is IP54.





Shower Enclosures

Luxurious, contemporary enclosures with 5mm-10mm tempered glass.

Many products benefit from a 10 year guarantee with easy-clean glass and a comprehensive range of shower trays.

Contents

Volente enclosures	416 - 434
Vulcan enclosures	435 - 438
Vantage enclosures	439 - 445
Corniche enclosures	446 - 449
Vanguard enclosures	450 - 453
Walk-in enclosures	454 - 469
Biava Wet Floor	470 - 471
Shower trays	472 - 479



Volente

VOLENTE FRAMELESS DOOR

Tempered Glass - 6mm 

1850 mm High 



For an alcove situation, a frameless wall profile is needed 58.714

Luxurious, easy to clean, contemporary frameless enclosure in 6mm tempered safety glass, height 1850mm.

FEATURES

- 10 Year manufacturer's guarantee*
 - Easy clean glass
 - Concealed fittings
 - Trays available to match
 - 6mm Tempered safety glass
 - Polished silver
- *With conditions

DOORS

Volente Frameless Door

Size	Adjustment	Door Opening	Code	£ Ex VAT	£ Inc VAT
700mm Door	668mm-690mm†	560mm	58.811	323.00	387.60
760mm Door	728mm-750mm†	620mm	58.812	332.00	398.40
800mm Door	768mm-790mm†	660mm	58.813	342.00	410.40
900mm Door	868mm-890mm†	760mm	58.814	350.00	420.00
1000mm Door	968mm-990mm†	860mm	58.815	363.00	435.60
Alcove wall profile	Adds 10mm	-	58.714	59.00	70.80

†Alcove wall profile adds 10mm to door adjustment.

EXTRAS

Volente Side Panel

Size	Adjustment	Code	£ Ex VAT	£ Inc VAT
700mm Side panel	672mm-690mm	58.614	242.00	290.40
760mm Side panel	732mm-750mm	58.615	242.00	290.40
800mm Side panel	772mm-790mm	58.616	242.00	290.40
900mm Side panel	872mm-890mm	58.611	251.00	301.20
1000mm Side panel	972mm-990mm	58.612	269.00	322.80
1200mm Side panel	1172mm-1190mm	58.613	304.00	364.80

EXTRAS

Volente Extension Profile*

Description	Code	£ Ex VAT	£ Inc VAT
31mm Extension profile	58.012	42.00	50.40

*Adds 31mm to overall size of door to give greater adjustment, can only be used with door, not on side panel.

VOLENTE DOUBLE SLIDING DOOR

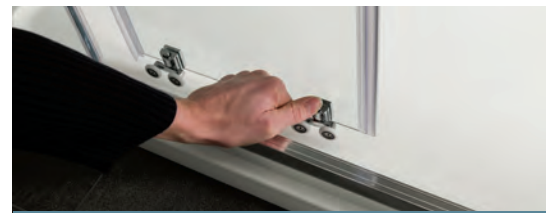
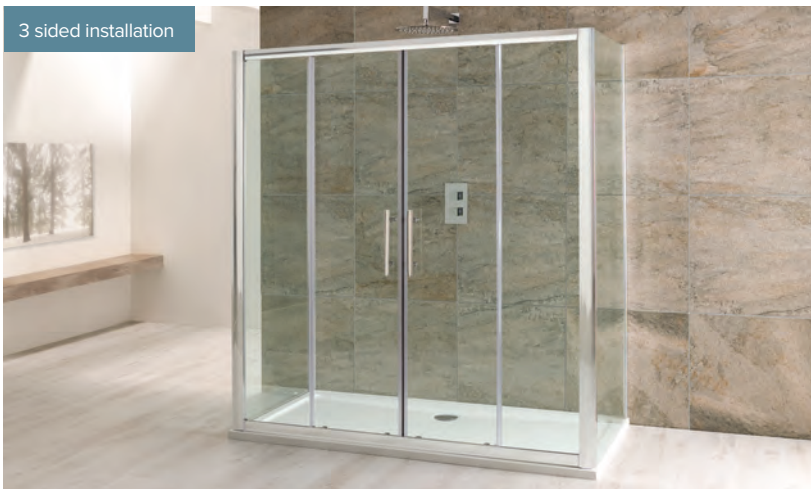

Runners release for ease of cleaning

Luxurious, easy to clean, contemporary framed enclosure in 6mm tempered safety glass, with central opening slider doors, 1850mm high.

FEATURES

- 10 Year manufacturer's guarantee*
 - Easy clean glass
 - Concealed fittings
 - Trays available to match
 - Power shower approved
 - 3 side installation possible
 - 6mm Tempered safety glass
 - Polished silver
- *With conditions

When fitting with 2 side panels (as illustrated) you will need to select the next smallest door size from your selected tray. For example: for a 900mm tray you will need an 800mm door. If the difference between the tray and the door is 100mm you will also need TWO extension profiles. Please call 01452 317890 for assistance if you are in any doubt.

DOORS

Volente Sliding Door

Size	Adjustment	Door Opening	Code	£ Ex VAT	£ Inc VAT
1200mm double sliding door	1160mm-1200mm	480mm	58.210	431.00	517.20
1400mm double sliding door	1360mm-1400mm	580mm	58.211	471.00	565.20
1500mm double sliding door	1460mm-1500mm	600mm	58.212	491.00	589.20
1600mm double sliding door	1560mm-1600mm	640mm	58.213	515.00	618.00
1700mm double sliding door	1660mm-1700mm	680mm	58.214	533.00	639.60
1800mm double sliding door	1760mm-1800mm	720mm	58.215	549.00	658.80
2000mm double sliding door	1960mm-2000mm	800mm	58.216	587.00	704.40

EXTRAS

Volente Side Panel

Size	Adjustment	Code	£ Ex VAT	£ Inc VAT
700mm Side panel	672mm-690mm	58.405	155.00	186.00
760mm Side panel	732mm-750mm	58.406	161.00	193.20
800mm Side panel	772mm-790mm	58.407	167.00	200.40
900mm Side panel	872mm-890mm	58.408	179.00	214.80
1000mm Side panel	972mm-990mm	58.409	196.00	235.20

EXTRAS

Volente Extension Profile*

Description	Code	£ Ex VAT	£ Inc VAT
31mm Extension profile	58.012	42.00	50.40

*Adds 31mm to overall size of door to give greater adjustment, can only be used with door, not on side panel.

Volente

VOLENTE SLIDER DOOR



Tempered Glass - 6mm 

1850 mm High 



3 sided installation



Runners release for ease of cleaning

Luxurious, easy to clean, contemporary framed enclosure in 6mm tempered safety glass, 1850mm high.

FEATURES

- 10 Year manufacturer's guarantee*
- Easy clean glass
- Concealed fittings
- Trays available to match
- Power shower approved
- 3 side installation possible
- 6mm Tempered safety glass
- Clear glass - also available in frosted glass
- Polished silver

When fitting with 2 side panels (as illustrated) you will need to select the next smallest door size from your selected tray. For example: for a 900mm tray you will need an 800mm door. If the difference between the tray and the door is 100mm you will also need TWO extension profiles. Please call 01452 317890 for assistance if you are in any doubt.

DOORS

Volente Sliding Door - Clear Glass

Size	Adjustment	Door Opening	Code	£ Ex VAT	£ Inc VAT
1000mm slider	970mm-1000mm	340mm	58.204	307.00	368.40
1100mm slider	1070mm-1100mm	450mm	58.205	322.00	386.40
1200mm slider	1170mm-1200mm	490mm	58.206	342.00	410.40
1300mm slider	1270mm-1300mm	550mm	58.200	355.00	426.00
1400mm slider	1370mm-1400mm	570mm	58.207	376.00	451.20
1500mm slider	1470mm-1500mm	650mm	58.201	390.00	468.00
1600mm slider	1570mm-1600mm	700mm	58.202	411.00	493.20
1700mm slider	1670mm-1700mm	750mm	58.203	425.00	510.00
1800mm slider	1770mm-1800mm	800mm	58.208	445.00	534.00
2000mm slider	1970mm-2000mm	875mm	58.209	465.00	307.00

EXTRAS

Volente Side Panel - Clear Glass

Size	Adjustment	Code	£ Ex VAT	£ Inc VAT
700mm Side panel	672mm-690mm	58.405	155.00	186.00
760mm Side panel	732mm-750mm	58.406	161.00	193.20
800mm Side panel	772mm-790mm	58.407	167.00	200.40
900mm Side panel	872mm-890mm	58.408	179.00	214.80

EXTRAS

Volente Extension Profile*

Description	Code	£ Ex VAT	£ Inc VAT
31mm Extension profile	58.012	42.00	50.40

*Adds 31mm to overall size of door to give greater adjustment, can only be used with door, not on side panel.

VOLENTE FROSTED SLIDER DOOR

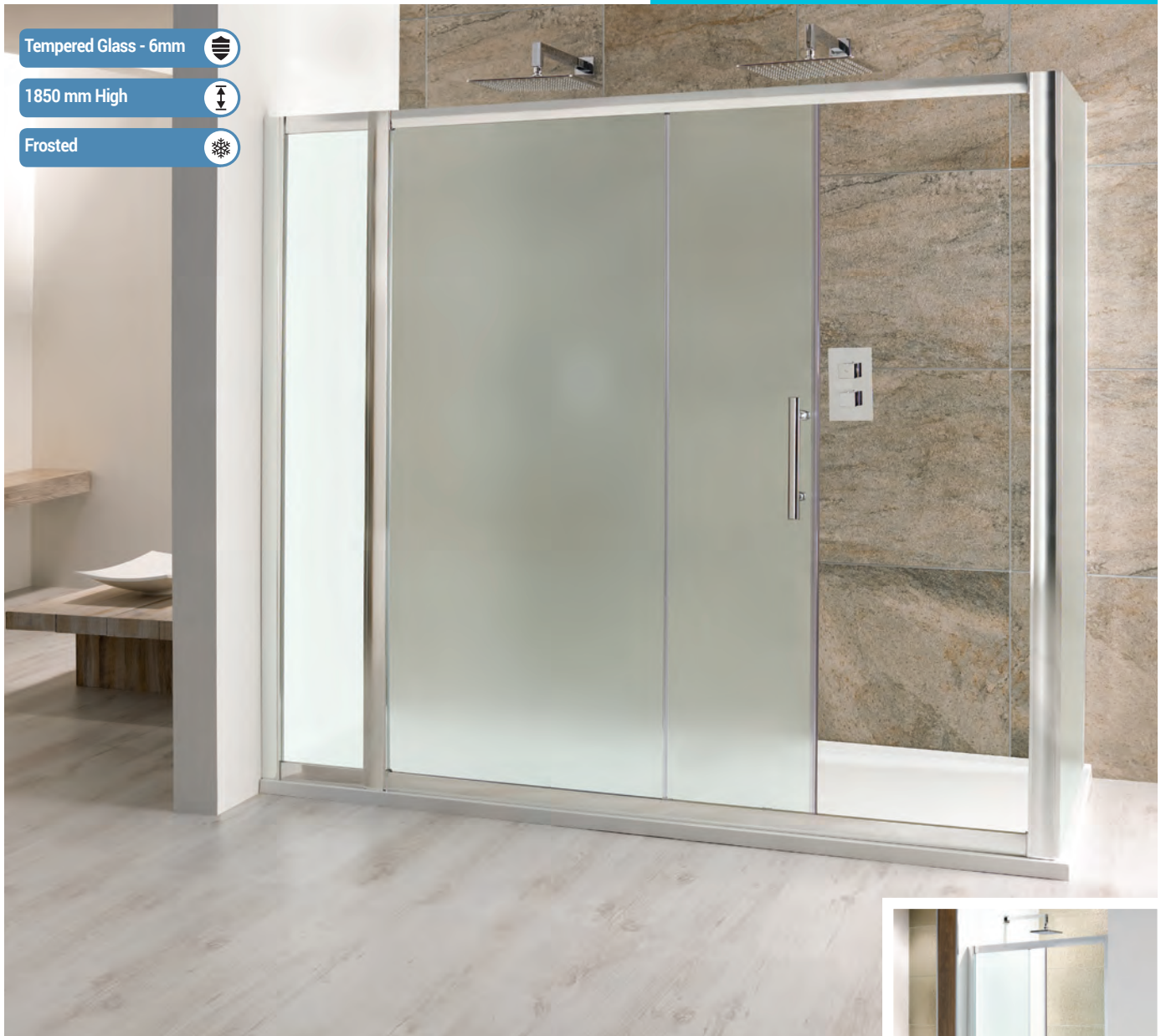

DOORS

Volente Slider Door - Frosted Glass

Size	Adjustment	Door Opening	Code	£ Ex VAT	£ Inc VAT
1000mm slider	970mm-1000mm	340mm	58.014	355.00	426.00
1100mm slider	1070mm-1100mm	450mm	58.015	372.00	446.40
1200mm slider	1170mm-1200mm	490mm	58.016	396.00	475.20
1300mm slider	1270mm-1300mm	550mm	58.017	416.00	499.20
1400mm slider	1370mm-1400mm	570mm	58.018	438.00	525.60
1500mm slider	1470mm-1500mm	650mm	58.019	457.00	548.40
1600mm slider	1570mm-1600mm	700mm	58.020	479.00	574.80
1700mm slider	1670mm-1700mm	750mm	58.021	498.00	597.60
1800mm slider	1770mm-1800mm	800mm	58.022	522.00	626.40
2000mm slider	1970mm-2000mm	875mm	58.023	563.00	675.60

EXTRAS

Volente Side Panel - Frosted Glass

Size	Adjustment	Code	£ Ex VAT	£ Inc VAT
700mm Side panel	672mm-690mm	58.024	179.00	214.80
760mm Side panel	732mm-750mm	58.025	189.00	226.80
800mm Side panel	772mm-790mm	58.026	198.00	237.60
900mm Side panel	872mm-890mm	58.027	212.00	254.40
1000mm Side panel	972mm-990mm	58.028	231.00	277.20

EXTRAS

Volente In-Line Panel - Frosted Glass

Size	Adjustment	Code	£ Ex VAT	£ Inc VAT
300mm in-line panel	300-325	58.024	179.00	214.80
300mm in-line panel with shelves	300-325	58.043	182.00	218.40
Volente in-line panel support bar	-	58.013	29.00	34.80



Volente

VOLENTE SLIDER WITH IN-LINE PANEL

Tempered Glass - 6mm



1850 mm High



VOLENTE SLIDER WITH IN-LINE PANEL

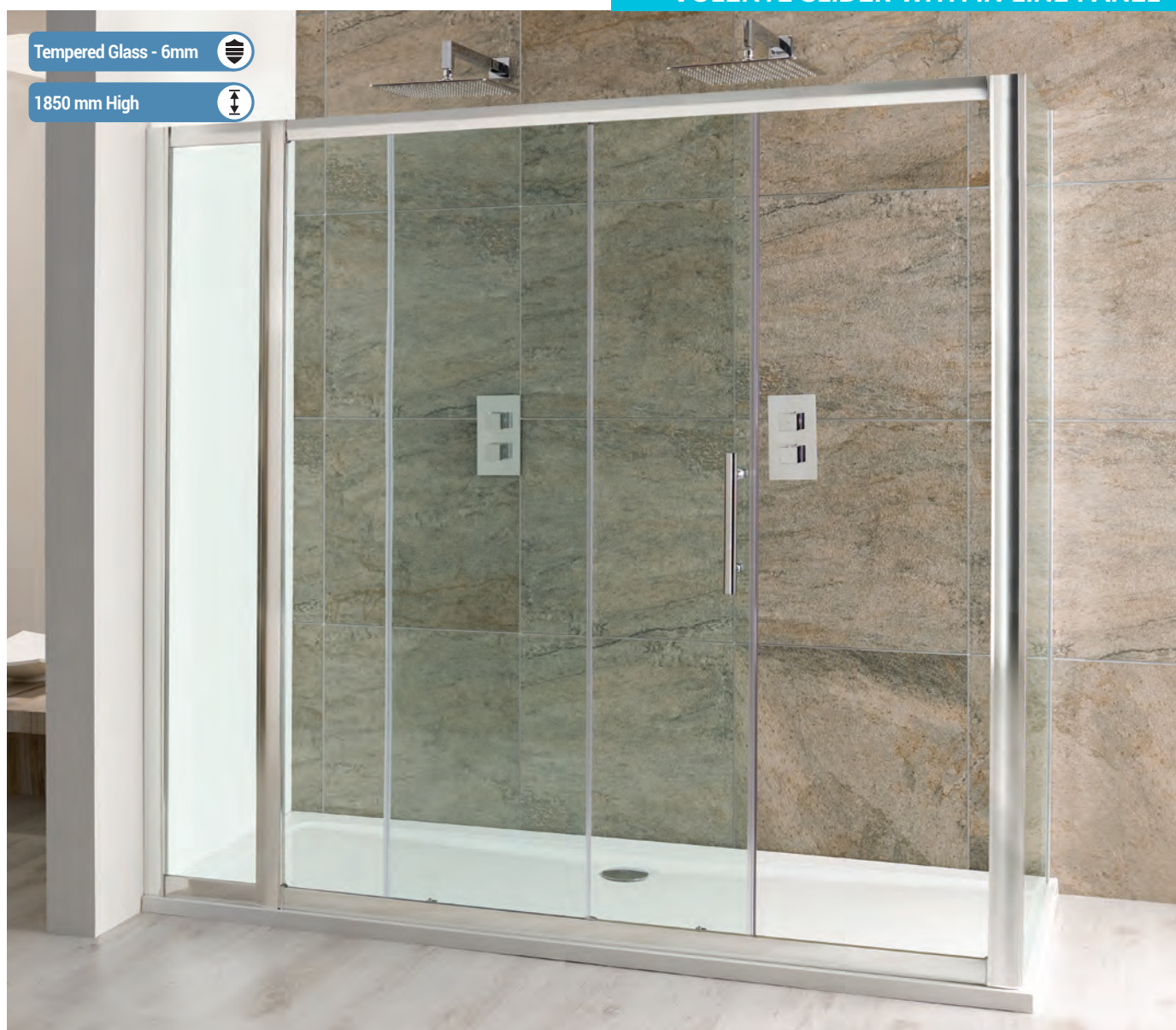

DOORS

Volente Slider with In-Line Panel

Size	Adjustment	Door Opening	Code	£ Ex VAT	£ Inc VAT
1000mm slider	970mm-1000mm	340mm	58.204	307.00	368.40
1100mm slider	1070mm-1100mm	450mm	58.205	322.00	386.40
1200mm slider	1170mm-1200mm	490mm	58.206	342.00	410.40
1400mm slider	1370mm-1400mm	570mm	58.207	376.00	451.20
1700mm slider	1670mm-1700mm	750mm	58.203	425.00	510.00

N.B. Volente in-line panel sold separately, sizes restricted to tray sizes available

EXTRAS

Volente Side Panel

Size	Adjustment	Code	£ Ex VAT	£ Inc VAT
700mm Side panel	672mm-690mm	58.405	155.00	186.00
760mm Side panel	732mm-750mm	58.406	161.00	193.20
800mm Side panel	772mm-790mm	58.407	167.00	200.40
900mm Side panel	872mm-890mm	58.408	179.00	214.80
1000mm Side panel	972mm-990mm	58.409	196.00	235.20

Volente in-Line Panel

Size	Adjustment	Code	£ Ex VAT	£ Inc VAT
300mm in-line panel	300mm-325mm	58.010	164.00	196.80
300mm in-line panel with shelves	300mm-325mm	58.011	186.00	223.20
Volente in-line panel support bar	-	58.013	29.00	34.80



Runners release for ease of cleaning

Luxurious, easy to clean, contemporary framed enclosure in 6mm tempered safety glass, 1850mm high, shown with in-line panel with optional shelves.

FEATURES

- 10 Year manufacturer's guarantee*
- Easy clean glass
- Concealed fittings
- Trays available to match
- Power shower approved
- 6mm Tempered safety glass
- Polished silver

*With conditions

Volente

VOLENTE QUAD

Tempered Glass - 6mm 

1850 mm High 



Runners release for ease of cleaning

Luxurious, easy to clean, contemporary framed enclosure in 6mm tempered safety glass, height 1850mm.

FEATURES

- 10 Year manufacturer's guarantee*
 - Easy clean glass
 - Concealed fittings
 - Trays available to match
 - Power shower approved
 - 6mm Tempered safety glass
 - Polished silver
- *With conditions

DOORS

Volente Quad

Size	Adjustment	Door Opening	Code	£ Ex VAT	£ Inc VAT
800mm	767mm-790mm	470mm	58.003	352.00	422.40
900mm	867mm-890mm	470mm	58.004	352.00	422.40
1000mm	967mm-990mm	540mm	58.006	419.00	502.80

EXTRAS

Volente Extension Profile*

Description	Code	£ Ex VAT	£ Inc VAT
31mm Extension profile	58.012	42.00	50.40

*Adds 31mm to overall size of door to give greater adjustment, can only be used with door, not on side panel.

VOLENTE QUAD WITH INLINE PANEL



Tempered Glass - 6mm



1850 mm High



Right Hand



Left Hand

Luxurious, easy to clean, contemporary framed enclosure in 6mm tempered safety glass, 1850mm high.

FEATURES

- 10 Year manufacturer's guarantee*
 - Easy clean glass
 - Concealed fittings
 - Trays available to match
 - Power shower approved
 - 6mm Tempered safety glass
 - Polished silver
- *With conditions

DOORS**Volente Quad**

Size	Adjustment	Door Opening	Code	£ Ex VAT	£ Inc VAT
900mm	867mm-890mm	470mm	58.004	352.00	422.40

EXTRAS**Volente In-Line Panel**

Description		Code	£ Ex VAT	£ Inc VAT
300mm in-line panel	300mm-325mm	58.010	164.00	196.80
300mm in-line panel with shelves	300mm-325mm	58.011	186.00	223.20
Volente inline panel support bar	-	58.013	29.00	34.80

N.B. Volente in-line panel sold separately, sizes restricted to tray sizes available.

Volente

VOLENTE CURVED CORNER

Tempered Glass - 6mm 

1850 mm High 



Right Hand Shown

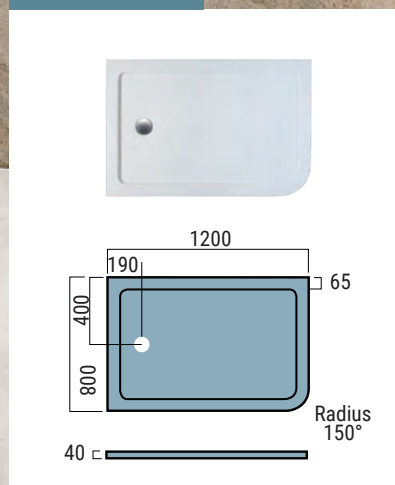

NB. Must order both 58.600 and 58.601 as both door and panel required to make enclosure.

DOORS

Volente Curved Corner

Size	Adjustment	Door Opening	Code	£ Ex VAT	£ Inc VAT
1200 x 800mm curved corner door**	782-800mm	760mm	58.600	280.00	336.00
1200 x 800mm curved corner panel**	1180-1200mm	-	58.601	349.00	418.80

** NB. Must order both 58.600 and 58.601 as both door and panel required to make enclosure. See Extras section below for trays to match.

EXTRAS

Volente Curved Corner

Description	Code	£ Ex VAT	£ Inc VAT
1200 x 800mm tray LH*	158.602	227.00	272.40
1200 x 800mm tray RH*	158.603	227.00	272.40
Legs and panel for 58.602/3	158.604	81.00	97.20
90mm Shower Waste	12.040	14.00	16.80
Volente Luxury Shower Waste Chrome	41.5000	17.00	20.40

* Price does not include shower waste (12.040 or 41.5000). 90mm shower waste required.

Luxurious, easy to clean, contemporary framed enclosure in 6mm tempered safety glass, height 1850mm.

FEATURES

- 10 Year manufacturer's guarantee*
 - Easy clean glass
 - Concealed fittings
 - Trays available to match
 - 6mm Tempered safety glass
 - Polished silver
- *With conditions

VOLENTE OFFSET QUAD



Tempered Glass - 6mm



1850 mm High



Runners release for ease of cleaning

Luxurious, easy to clean, contemporary framed enclosure in 6mm tempered safety glass, height 1850mm.

FEATURES

- 10 Year manufacturer's guarantee*
- Easy clean glass
- Concealed fittings
- Trays available to match
- Power shower approved
- 6mm Tempered safety glass
- Polished silver

*With conditions

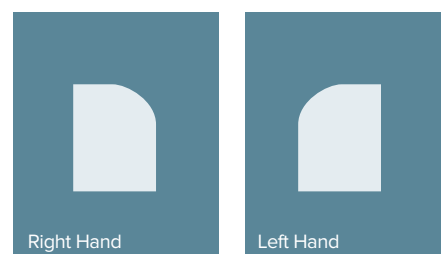

Right Hand

Left Hand

Offset Quadrant reversible left hand or right hand.

DOORS

Volente Offset Quad

Size	Adjustment	Door Opening	Code	£ Ex VAT	£ Inc VAT
900 x 700mm	867-890/667-690mm	367mm	58.049	395.00	474.00
1000 x 700mm	967-990/667-690mm	367mm	58.123	408.00	489.60
1000 x 800 mm	967-990/767-700mm	470mm	58.107	419.00	502.80
1000 x 900 mm	967-990/867-890mm	540mm	58.108	419.00	502.80
1100 x 700 mm	1067-1090/667-690mm	367mm	58.124	429.00	514.80
1100 x 760 mm	1067-1090/727-750mm	445mm	58.109	443.00	531.60
1100 x 800 mm	1067-1090/767-790mm	480mm	58.120	429.00	514.80
1100 x 900 mm	1067-1090/867-890mm	540mm	58.121	429.00	514.80
1200 x 700 mm	1167-1190/667-690mm	367mm	58.122	451.00	541.20
1200 x 800 mm	1167-1190/767-790mm	470mm	58.105	460.00	552.00
1200 x 900 mm	1167-1190/867-890mm	540mm	58.106	460.00	552.00
1300 x 760 mm	1267-1290/727-790mm	480mm	58.125	472.00	566.40
1300 x 800 mm	1267-1290/767-799mm	480mm	58.126	472.00	566.40
1400 x 760 mm	1367-1390/727-790mm	480mm	58.127	493.00	591.60
1400 x 800 mm	1367-1390/767-790mm	480mm	58.128	493.00	591.60

EXTRAS

Volente Extension Profile*

Description	Code	£ Ex VAT	£ Inc VAT
31mm Extension profile	58.012	42.00	50.40

Volente Extension Profile - Adds 31mm to overall size of door to give greater adjustment.

Volente

VOLENTE SINGLE DOOR QUAD

Tempered Glass - 6mm 

1850 mm High 



Door is reversible.
Enclosure requires special tray, see below.

DOORS

Volente Single Door Quad

Size	Adjustment	Door Opening	Code	£ Ex VAT	£ Inc VAT
800mm door	767-782mm	450mm	58.007*	261.00	313.20
900mm door	862-882mm	550mm	58.008*	261.00	313.20
1000mm door	962-982mm	600mm	58.009*	391.00	469.20

*Requires special tray - see below for matching trays and Legs & Panels.

TRAYS TO MATCH

Bow Fronted Trays to match Volente Single Door Quad

Size	Waste Size	A	B	C	D	E	F	H	Code	£ Ex VAT	£ Inc VAT
800 x 800*	90	800	800	40	65	190	190	598	158.618	197.00	236.40
900 x 900*	90	900	900	40	65	190	190	673	158.619	200.00	240.00
1000 x 1000*	90	1000	1000	40	65	190	190	748	158.620	217.00	260.40

*Price does not include shower waste

EXTRAS

Description	Code	£ Ex VAT	£ Inc VAT
Volente legs & panel for 58.007 tray	158.621	89.00	106.80
Volente legs & panel for 58.008 tray	158.622	91.00	109.20
Volente legs & panel for 58.009 tray	158.623	94.00	112.80
90mm Shower Waste	12.040	14.00	16.80

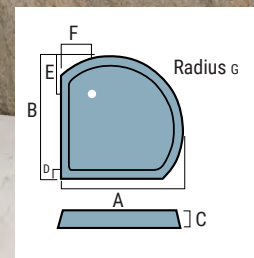

Runners release for ease of cleaning

Luxurious, easy to clean, contemporary framed enclosure in 6mm tempered safety glass, height 1850mm.

FEATURES

- 10 Year manufacturer's guarantee*
 - Easy clean glass
 - Concealed fittings
 - Trays available to match
 - Power shower approved
 - 6mm Tempered safety glass
 - Polished silver
- *With conditions

VOLENTE SINGLE DOOR OFFSET QUAD



Tempered Glass - 6mm 

1850 mm High 

● Door handle - position when closed. Only available opening as shown. Position of large panel may vary depending on size of enclosure. Enclosure can be fitted on left or right handed tray.

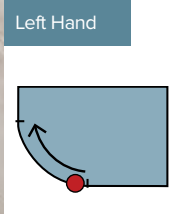
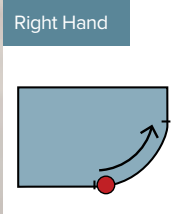

Runners release for ease of cleaning

1200 x 900mm enclosure shown in left hand.

DOORS

Volente Single Door Offset Quad

Size	Adjustment	Door Opening	Code	£ Ex VAT	£ Inc VAT
900 x 760mm door	870-893 x 730-753	420mm	58.110	381.00	457.20
900 x 800mm door	870-893 x 770-793	440mm	58.111	381.00	457.20
1000 x 760mm door	970-993 x 730-753	420mm	58.112	454.00	544.80
1000 x 800mm door	970-993 x 770-793	440mm	58.113	454.00	544.80
1000 x 900mm door	970-993 x 870-893	470mm	58.114	454.00	544.80
1200 x 760mm door	1170-1193 x 730-753	420mm	58.115	499.00	598.80
1200 x 800mm door	1170-1193 x 770-793	440mm	58.116	499.00	598.80
1200 x 900mm door	1170-1193 x 870-893	470mm	58.117	499.00	598.80

Note: 550mm radius on tray.

Luxurious, easy to clean, contemporary framed enclosure in 6mm tempered safety glass, height 1850mm.

FEATURES

- 10 Year manufacturer's guarantee*
 - Easy clean glass
 - Concealed fittings
 - Trays available to match
 - Power shower approved
 - 6mm Tempered safety glass
 - Polished silver
- *With conditions

Volente

VOLENTE SPACESAVER QUAD

Tempered Glass - 6mm 

1850 mm High 

1650 x 912/700mm. LH shown, runners release for easy cleaning.



All diagrams shown are left hand

Note

During the life of this brochure, the design of these trays will change. When ordering, please check you have ordered the correct waste.

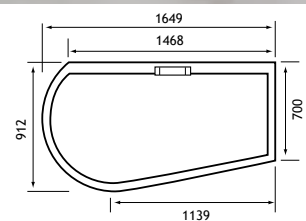
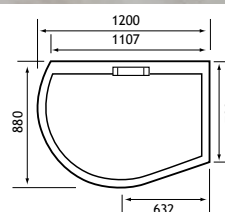
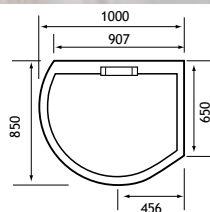

VOLENTE SPACESAVER QUAD



DOORS

Volente Spacesaver Offset Quad

Size	Door Opening	Code	£ Ex VAT	£ Inc VAT
1000 x 850/650	560mm	58.104	364.00	436.80
1200 x 880/700	520mm	58.100	404.00	484.80
1650 x 912/700	500mm	58.101	517.00	620.40

EXTRAS

TRAYS

Description	Code	£ Ex VAT	£ Inc VAT
LH Tray for 58.104*	158.730	126.00	151.20
RH Tray for 58.104*	158.731	126.00	151.20
LH Tray for 58.100*	158.732	139.00	166.80
RH Tray for 58.100*	158.734	139.00	166.80
LH Tray for 58.101*	158.735	214.00	256.80
RH Tray for 58.101*	158.736	214.00	256.80
50mm Shower Waste	158.737	14.00	16.80
Volente 1400 x 900 tray for curved walkin	158.738	282.00	338.40
Volente 1500 x 900 tray for curved walkin	158.739	300.00	360.00

*Must be fitted with 158.737



Right hand shown, 1000 x 850/650mm

Luxurious, easy to clean, contemporary framed enclosure with a unique space saving shape allowing it to fit into smaller spaces but still providing luxurious room to shower.

FEATURES

- 10 Year manufacturer's guarantee*
- Easy clean glass
- Integral waste
- Trays available to match
- Power shower approved
- 6mm Tempered safety glass
- 1850 mm high
- Polished silver
- Integral waste
- *With conditions

Volente

VOLENTE HINGED DOOR

Tempered Glass - 6mm 

1850 mm High 



In-line panel must be fitted to hinge side of the door as illustrated, and fitted with a 58.013 support bar.

Luxurious, easy to clean, contemporary framed enclosure in 6mm tempered safety glass, height 1850mm.

FEATURES

- 10 Year manufacturer's guarantee*
 - Easy clean glass
 - Concealed fittings
 - Trays available to match
 - 6mm Tempered safety glass
 - Clear glass - also available in frosted glass
 - Polished silver
- *With conditions

DOORS

Volente Hinged Door - Clear Glass

Size	Adjustment	Door Opening	Code	£ Ex VAT	£ Inc VAT
700mm door	660mm-700mm	560mm	58.305	310.00	372.00
760mm door	720mm-760mm	620mm	58.306	319.00	382.80
800mm door	760mm-800mm	660mm	58.307	325.00	390.00
900mm door	860mm-900mm	760mm	58.308	348.00	417.60
1000mm door	960mm-1000mm	860mm	58.309	376.00	451.20

EXTRAS

Volente Side Panel - Clear Glass

Size	Adjustment	Code	£ Ex VAT	£ Inc VAT
700mm Side panel	672mm-690mm	58.405	155.00	186.00
760mm Side panel	732mm-750mm	58.406	161.00	193.20
800mm Side panel	772mm-790mm	58.407	167.00	200.40
900mm Side panel	872mm-890mm	58.408	179.00	214.80
1000mm Side panel	972mm-990mm	58.409	196.00	235.20

EXTRAS

Volente in-Line Panel

Size	Adjustment	Code	£ Ex VAT	£ Inc VAT
300mm in-line panel*	300mm-325mm	58.010	164.00	196.80
300mm in-line panel with shelves*	300mm-325mm	58.011	186.00	223.20
Volente in-line panel support bar	-	58.013	29.00	34.80

*Must be fitted with a 58.013 support bar

EXTRAS

Volente Extension Profile*

Description	Code	£ Ex VAT	£ Inc VAT
31mm Extension profile	58.012	42.00	50.40

*Adds 31mm to overall size of door to give greater adjustment, can only be used with door, not on side panel.

VOLENTE FROSTED HINGED DOOR



Luxurious, easy to clean, contemporary framed enclosure in 6mm tempered safety glass, height 1850mm.

FEATURES

- 10 Year manufacturer's guarantee*
- Easy clean glass
- Concealed fittings
- Trays available to match
- 6mm Tempered safety glass
- Frosted glass - also available in clear glass
- Polished silver

*With conditions

Tempered Glass - 6mm 

1850 mm High 

Frosted 

DOORS

Volente Hinged Door - Frosted Glass

Size	Adjustment	Door Opening	Code	£ Ex VAT	£ Inc VAT
700mm door	660mm-700mm	560mm	58.037	355.00	426.00
760mm door	720mm-760mm	620mm	58.038	365.00	438.00
800mm door	760mm-800mm	660mm	58.039	374.00	448.80
900mm door	860mm-900mm	760mm	58.040	402.00	482.40
1000mm door	960mm-1000mm	860mm	58.041	432.00	518.40

EXTRAS

Volente Side Panel - Frosted Glass

Size	Adjustment	Code	£ Ex VAT	£ Inc VAT
700mm Side panel	672mm-690mm	58.024	179.00	214.80
760mm Side panel	732mm-750mm	58.025	189.00	226.80
800mm Side panel	772mm-790mm	58.026	198.00	237.60
900mm Side panel	872mm-890mm	58.027	212.00	254.40
1000mm Side panel	972mm-990mm	58.028	231.00	277.20

EXTRAS

Volente In-Line Panel - Frosted Glass

Size	Adjustment	Code	£ Ex VAT	£ Inc VAT
300mm in-line panel*	300-325	58.024	179.00	214.80
300mm in-line panel with shelves*	300-325	58.043	182.00	218.40
Volente In-line Panel Support Bar	-	58.013	29.00	34.80

*Must be fitted with a 58.013 support bar

Volente

VOLENTE BI-FOLD DOOR



Luxurious, easy to clean, contemporary framed enclosure in 6mm tempered safety glass, height 1850mm.

FEATURES

- 10 Year manufacturer's guarantee*
- Easy clean glass
- Concealed fittings
- Trays available to match
- 3 side installation possible
- 6mm Tempered safety glass
- Polished silver
- *With conditions

When fitting with 2 side panels (as illustrated above) you will need to select the next smallest door size from your selected tray. For example: for a 900mm tray you will need an 800mm door. If the difference between the tray and the door is 100mm you will also need TWO extension profiles. Please call 01452 317890 for assistance if you are in any doubt.

DOORS

Volente Bi-Fold Door

Size	Adjustment	Door Opening	Code	£ Ex VAT	£ Inc VAT
700mm door	654mm-700mm	480mm	58.501	276.00	331.20
760mm door	714mm-760mm	520mm	58.502	286.00	343.20
800mm door	754mm-800mm	580mm	58.503	294.00	352.80
900mm door	854mm-900mm	650mm	58.504	304.00	364.80
1000mm door	954mm-1000mm	720mm	58.505	322.00	386.40

EXTRAS

Volente Side Panel

Size	Adjustment	Code	£ Ex VAT	£ Inc VAT
700mm Side panel	672mm-690mm	58.405	155.00	186.00
760mm Side panel	732mm-750mm	58.406	161.00	193.20
800mm Side panel	772mm-790mm	58.407	167.00	200.40
900mm Side panel	872mm-890mm	58.408	179.00	214.80
1000mm Side panel	972mm-990mm	58.409	196.00	235.20

Volente Extension Profile*

Description	Code	£ Ex VAT	£ Inc VAT
31mm Extension profile	58.012	42.00	50.40

*Adds 31mm to overall size of door to give greater adjustment, can only be used with door, not on side panel.

VOLENTE BI-FOLD DOOR WITH IN-LINE PANEL

Tempered Glass - 6mm



1850 mm High



In-line panel must be fitted to hinge side of the door as illustrated.



Luxurious, easy to clean, contemporary framed enclosure in 6mm tempered safety glass, height 1850mm, shown here with inline panel which is sold separately.

FEATURES

- 10 Year manufacturer's guarantee*
 - Easy clean glass
 - Concealed fittings
 - Trays available to match
 - 6mm Tempered safety glass
 - Polished silver
- *With conditions

DOORS**Volente Bi-Fold Door with In-Line Panel**

Size	Adjustment	Door Opening	Code	£ Ex VAT	£ Inc VAT
700mm door	654mm-700mm	480mm	58.501	276.00	331.20
760mm door	714mm-760mm	520mm	58.502	286.00	343.20
800mm door	754mm-800mm	580mm	58.503	294.00	352.80
900mm door	854mm-900mm	650mm	58.504	304.00	364.80
1000mm door	954mm-1000mm	720mm	58.505	322.00	386.40

*N.B. Volente in-line panel sold separately, sizes restricted to tray sizes available

EXTRAS**Volente Side Panel**

Size	Adjustment	Code	£ Ex VAT	£ Inc VAT
700mm Side panel	672mm-690mm	58.405	155.00	186.00
760mm Side panel	732mm-750mm	58.406	161.00	193.20
800mm Side panel	772mm-790mm	58.407	167.00	200.40
900mm Side panel	872mm-890mm	58.408	179.00	214.80
1000mm Side panel	972mm-990mm	58.409	196.00	235.20

Volente in-Line Panel

Size	Adjustment	Code	£ Ex VAT	£ Inc VAT
300mm in-line panel	300mm-325mm	58.010	164.00	196.80
300mm in-line panel with shelves	300mm-325mm	58.011	186.00	223.20
Volente in-line panel support bar	-	58.013	29.00	34.80

Volente

VOLENTE DOUBLE HINGE DOOR

Tempered Glass - 6mm 

1850 mm High 

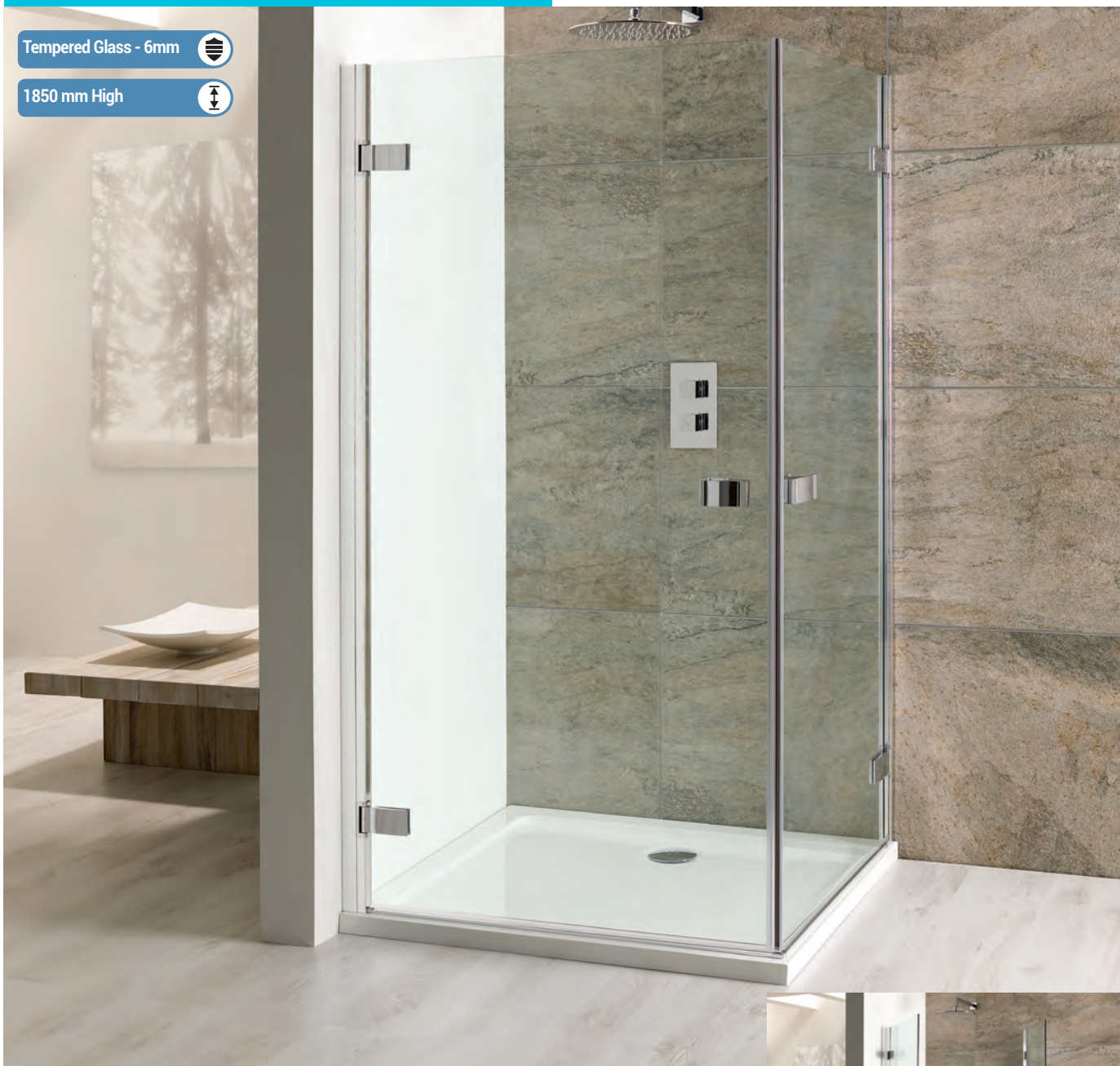

DOORS

Volente Double Hinge Door

Size	Adjustment	Door Opening	Code	£ Ex VAT	£ Inc VAT
800 x 800mm door	772-795mm	660 x 660mm	58.801	580.00	696.00
900 x 760mm door	872-895 x 732-755mm	760 x 620mm	58.809	588.00	705.60
900 x 800mm door	872-895 x 772-795mm	760 x 660mm	58.804	601.00	721.20
900 x 900mm door	872-895 x 872-895mm	760 x 760mm	58.802	601.00	721.20
1000 x 760mm door	972-995 x 732-755mm	860 x 620mm	58.810	601.00	721.20
1000 x 800mm door	972-995 x 772-795mm	860 x 660mm	58.807	601.00	721.20
1000 x 900mm door	972-995 x 872-895mm	860 x 760mm	58.808	609.00	730.80
1000 x 1000mm door	972-995 x 972-995mm	860 x 860mm	58.803	622.00	746.40
1200 x 800mm door	1172-1195 x 772-795mm	1060 x 660mm	58.805	622.00	746.40
1200 x 900mm door	1172-1195 x 872-895mm	1060 x 760mm	58.806	630.00	756.00

EXTRAS

Volente Extension Profile*

Description	Code	£ Ex VAT	£ Inc VAT
31mm Extension profile	58.012	42.00	50.40

*Adds 31mm to overall size of door to give greater adjustment, can only be used with door, not on side panel.



Luxurious, easy to clean, contemporary framed enclosure in 6mm tempered safety glass, height 1850mm.

FEATURES

- 10 Year manufacturer's guarantee*
 - Easy clean glass
 - Concealed fittings
 - Trays available to match
 - 6mm Tempered safety glass
 - Polished silver
- *With conditions

VULCAN QUAD



Tempered Glass - 5mm 

1850 mm High 

An affordable, classic design enclosure with 5mm tempered safety glass, 1850mm height and quick release rollers.

FEATURES

- 10 Year manufacturer's guarantee*
 - 5mm Tempered safety glass
 - Polished silver
- *With conditions

DOORS

Vulcan Quad

Size	Adjustment	Door Opening	Code	£ Ex VAT	£ Inc VAT
800 Quad	780 x 800mm	410mm	69.0001	266.00	319.20
900 Quad	880 x 900mm	510mm	69.0002	280.00	336.00



Runners release for ease of cleaning

Vulcan

VULCAN HINGE DOOR

Tempered Glass - 5mm 

1850 mm High 

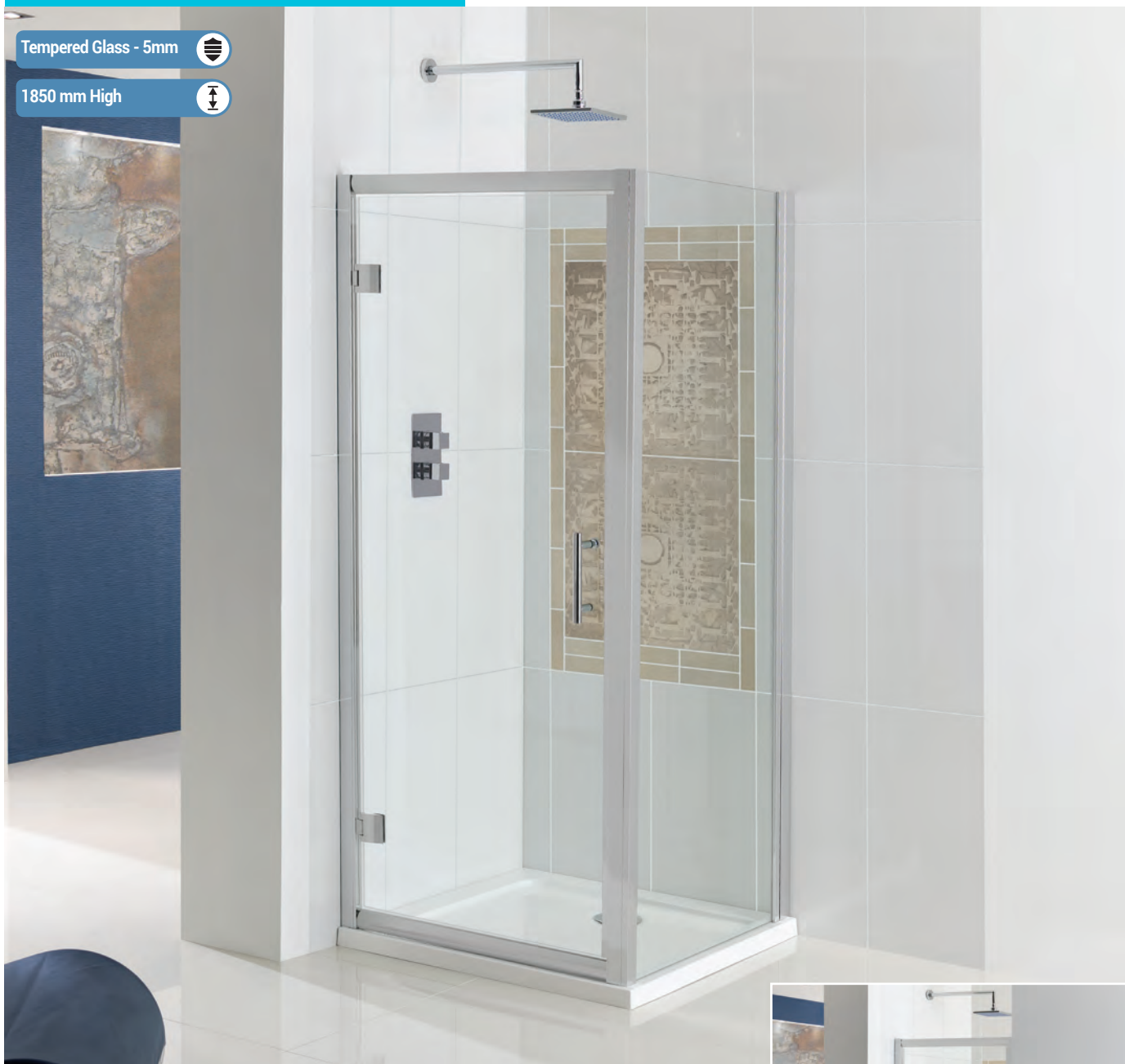

DOORS

Vulcan Hinge Door

Size	Adjustment	Door Opening	Code	£ Ex VAT	£ Inc VAT
700mm door	680mm - 700mm	535mm	69.0003	199.00	238.80
760mm door	740mm - 760mm	595mm	69.0004	204.00	244.80
800mm door	780mm - 800mm	635mm	69.0005	208.00	249.60
900mm door	880mm - 900mm	735mm	69.0006	224.00	268.80
1000mm door	980mm - 1000mm	835mm	69.0007	230.00	276.00

EXTRAS

Vulcan Side Panel

Size	Adjustment	Code	£ Ex VAT	£ Inc VAT
700mm side panel	660mm - 700mm	69.0008	118.00	141.60
760mm side panel	720mm - 760mm	69.0010	121.00	145.20
800mm side panel	760mm - 800mm	69.0011	125.00	150.00
900mm side panel	860mm - 900mm	69.0012	133.00	159.60
1000mm side panel	960mm - 1000mm	69.0013	140.00	168.00



An affordable, classic design enclosure with 5mm tempered safety glass, 1850mm height.

FEATURES

- 10 Year manufacturer's guarantee*
- 5mm Tempered safety glass
- Polished silver

*With conditions

VULCAN SLIDER DOOR



Runners release for ease of cleaning

An affordable, classic design enclosure with 5mm tempered safety glass, 1850mm height and quick release rollers.

FEATURES

- 10 Year manufacturer's guarantee*
- 5mm Tempered safety glass
- Polished silver
- *With conditions

DOORS**Vulcan Slider Door**

Size	Adjustment	Door Opening	Code	£ Ex VAT	£ Inc VAT
1000mm door	980mm - 1000mm	390mm	69.0014	227.00	272.40
1100mm door	1080mm - 1100mm	440mm	69.0015	241.00	289.20
1200mm door	1180mm - 1200mm	490mm	69.0016	246.00	295.20
1300mm door	1280mm - 1300mm	540mm	69.0017	255.00	306.00
1400mm door	1380mm - 1400mm	590mm	69.0018	273.00	327.60
1500mm door	1480mm - 1500mm	640mm	69.0019	281.00	337.20
1600mm door	1580mm - 1600mm	690mm	69.0020	285.00	342.00
1700mm door	1680mm - 1700mm	690mm	69.0021	301.00	361.20

EXTRAS**Vulcan Side Panel**

Size	Adjustment	Code	£ Ex VAT	£ Inc VAT
700mm side panel	660mm - 700mm	69.0008	118.00	141.60
760mm side panel	720mm - 760mm	69.0010	121.00	145.20
800mm side panel	760mm - 800mm	69.0011	125.00	150.00
900mm side panel	860mm - 900mm	69.0012	133.00	159.60

Vulcan

VULCAN BI-FOLD DOOR

Tempered Glass - 5mm



1850 mm High



DOORS

Vulcan Bi-Fold Door

Size	Adjustment	Door Opening	Code	£ Ex VAT	£ Inc VAT
700mm door	680mm - 700mm	430mm	69.0055	199.00	238.80
760mm door	740mm - 760mm	480mm	69.0056	204.00	244.80
800mm door	780mm - 800mm	515mm	69.0057	208.00	249.60
900mm door	880mm - 900mm	590mm	69.0058	219.00	262.80

EXTRAS

Vulcan Side Panel

Size	Adjustment	Code	£ Ex VAT	£ Inc VAT
700mm side panel	660mm - 700mm	69.0008	118.00	141.60
760mm side panel	720mm - 760mm	69.0010	121.00	145.20
800mm side panel	760mm - 800mm	69.0011	125.00	150.00
900mm side panel	860mm - 900mm	69.0012	133.00	159.60
1000mm side panel	960mm - 1000mm	69.0013	140.00	168.00

An affordable, classic design enclosure with 5mm tempered safety glass, 1850mm height and quick release rollers.

FEATURES

- 10 Year manufacturer's guarantee*
 - 5mm Tempered safety glass
 - Polished silver
- *With conditions

VANTAGE PIVOT DOOR



Tempered Glass - 6mm



1850 mm High



DOORS

Vantage Pivot Door

Size	Adjustment	Door Opening	Code	£ Ex VAT	£ Inc VAT
700mm door	670mm-695mm	475mm	69.0082	260.00	312.00
760mm door	730mm-755mm	535mm	69.0083	268.00	321.60
800mm door	770mm-795mm	575mm	69.0084	270.00	324.00
900mm door	870mm-895mm	675mm	69.0085	284.00	340.80
1000mm door	970mm-995mm	775mm	69.0086	345.00	414.00

Adjustment varies when fitted with a side panel

EXTRAS

Vantage Side Panel

Size	Adjustment	Code	£ Ex VAT	£ Inc VAT
700mm Side panel	685mm-700mm	69.0092	223.00	267.60
760mm Side panel	745mm-760mm	69.0093	227.00	272.40
800mm Side panel	785mm-800mm	69.0094	233.00	279.60
900mm Side panel	885mm-900mm	69.0095	238.00	285.60
1000mm Side panel	985mm-1000mm	69.0100	243.00	291.60

Side Panel with Towel Rail

Size	Adjustment	Code	£ Ex VAT	£ Inc VAT
700mm Side panel with rail	685mm-700mm	69.0096	270.00	324.00
760mm Side panel with rail	745mm-760mm	69.0097	271.00	325.20
800mm Side panel with rail	785mm-800mm	69.0098	272.00	326.40
900mm Side panel with rail	885mm-900mm	69.0099	279.00	334.80

Vantage pivot door, 6mm tempered safety glass, 1850mm high

FEATURES

- 10 Year manufacturer's guarantee*
- Easy clean glass
- Trays available to match
- Suitable for power shower
- 6mm Tempered safety glass
- Polished silver

*With conditions

Vantage

VANTAGE QUADRANT - WHITE



Tempered Glass - 6mm 

1850 mm High 

Vantage quadrant, 6mm tempered safety glass, 1850mm high

FEATURES

- 10 Year manufacturer's guarantee*
 - Easy clean glass
 - Suitable for power showers
 - Trays available to match
 - 6mm Tempered safety glass
 - White finish - also available in silver
- *With conditions



Runners release for ease of cleaning

DOORS

Vantage Quadrant - White

Size	Adjustment	Door Opening	Colour	Code	£ Ex VAT	£ Inc VAT
800mm	870mm-900mm	520mm	White	69.0022	334.00	400.80
900mm	870mm-900mm	520mm	White	69.0023	334.00	400.80

VANTAGE QUADRANT - SILVER



Tempered Glass - 6mm



1850 mm High



Vantage quadrant, 6mm tempered glass, 1850mm high

FEATURES

- 10 Year manufacturer's guarantee*
 - Easy clean glass
 - Suitable for power showers
 - Trays available to match
 - 6mm Tempered safety glass
 - Polished silver - also available in white
- *With conditions



Runners release for ease of cleaning

DOORS**Vantage Quadrant - Silver**

Size	Adjustment	Door Opening	Colour	Code	£ Ex VAT	£ Inc VAT
800mm	770mm-800mm	420mm	Silver	69.0024	349.00	418.80
900mm	870mm-900mm	520mm	Silver	69.0025	349.00	418.80
1000mm	970mm-1000mm	520mm	Silver	69.0026	412.00	494.40

Vantage

VANTAGE SLIDING DOOR



Runners release for ease of cleaning

Vantage sliding door, 6mm tempered glass, 1850mm high.

FEATURES

- 10 Year manufacturer's guarantee*
 - Easy clean glass
 - Suitable for power showers
 - Trays available to match
 - 6mm Tempered safety glass
 - Polished silver
- *With conditions

DOORS

Vantage Sliding Door

Size	Adjustment	Door Opening	Code	£ Ex VAT	£ Inc VAT
1000mm door	970mm-1000mm	410mm	69.0069	345.00	414.00
1100mm door	1070mm-1100mm	460mm	69.0070	351.00	421.20
1200mm door	1170mm-1200mm	510mm	69.0071	360.00	432.00
1400mm door	1370mm-1400mm	610mm	69.0072	378.00	453.60
1600mm door	1570mm-1600mm	710mm	69.0073	398.00	477.60
1650mm door	1620mm-1650mm	735mm	69.260	404.00	484.80
1700mm door	1670mm-1700mm	760mm	69.0074	408.00	489.60

Adjustment varies when fitted with a side panel

EXTRAS

Vantage Side Panel

Size	Adjustment	Code	£ Ex VAT	£ Inc VAT
700mm Side panel	685mm-700mm	69.0092	223.00	267.60
760mm Side panel	745mm-760mm	69.0093	227.00	272.40
800mm Side panel	785mm-800mm	69.0094	233.00	279.60
900mm Side panel	885mm-900mm	69.0095	238.00	285.60
1000mm Side panel	985mm-1000mm	69.0100	243.00	291.60

Side Panel with Towel Rail

Size	Adjustment	Code	£ Ex VAT	£ Inc VAT
700mm Side panel with rail	685mm-700mm	69.0096	270.00	324.00
760mm Side panel with rail	745mm-760mm	69.0097	271.00	325.20
800mm Side panel with rail	785mm-800mm	69.0098	272.00	326.40
900mm Side panel with rail	885mm-900mm	69.0099	279.00	334.80

VANTAGE CORNER ENTRY & OFFSET CORNER ENTRY



Tempered Glass - 6mm 

1850 mm High 

Vantage offset corner entry 6mm tempered glass, 1850mm high.

FEATURES

- 10 Year manufacturer's guarantee*
- Easy clean glass
- Suitable for power showers
- Trays available to match
- 6mm Tempered safety glass
- Polished silver
- *With conditions



Runners release for ease of cleaning



DOORS

Vantage Corner Entry & Offset Corner Entry

Size	Adjustment	Door Opening	Code	£ Ex VAT	£ Inc VAT
800 x 800mm	770-800 x 770-800	435mm	69.0127	419.00	502.80
900 x 700mm	870-900 x 670-700	450mm	69.0165	410.00	492.00
900 x 760mm	870-900 x 730-760	470mm	69.0123	454.00	544.80
900 x 800mm	870-900 x 770-800	480mm	69.0124	454.00	544.80
900 x 900mm	870-900 x 870-900	510mm	69.0128	430.00	516.00
1000 x 760mm	970-1000 x 730-760	495mm	69.0125	456.00	547.20

Vantage

VANTAGE OFFSET QUADRANT

Tempered Glass - 6mm 

1850 mm High 

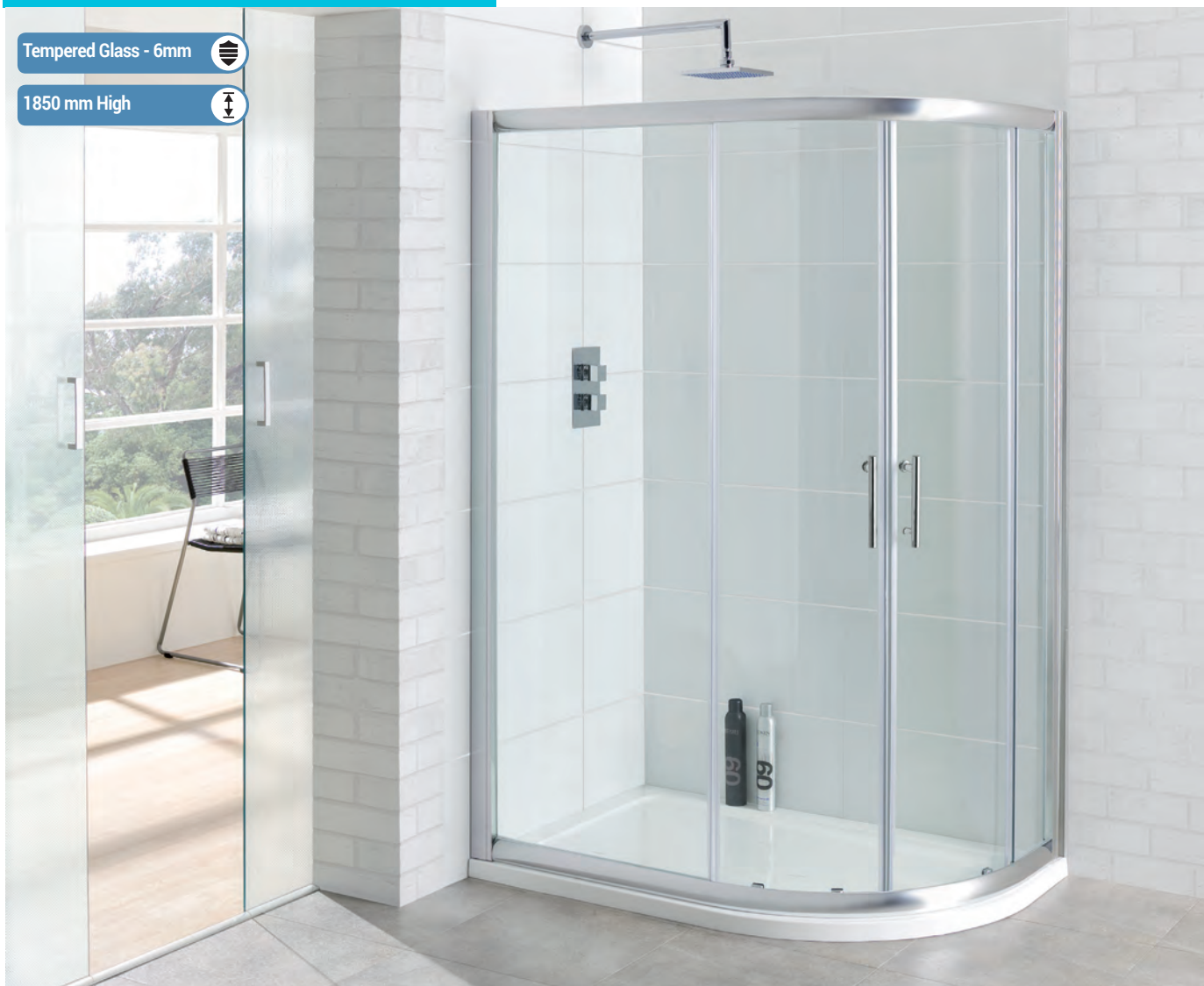

DOORS

Vantage Offset Quadrant

Size	Adjustment	Door Opening	Code	£ Ex VAT	£ Inc VAT
900 x 760mm	870-900mm x 730-760mm	450mm	69.0032	462.00	554.40
900 x 800mm	870-900mm x 770-800mm	470mm	69.0027	399.00	478.80
1000 x 760mm	970-1000mm x 730-760mm	450mm	69.0033	489.00	586.80
1000 x 800mm	970-1000mm x 770-800mm	470mm	69.0030	431.00	517.20
1000 x 900mm	970-1000mm x 870-900mm	520mm	69.0031	447.00	536.40
1100 x 760mm	1070-1100mm x 730-760mm	450mm	69.0159	482.00	578.40
1100 x 800mm	1070-1100mm x 770-800mm	470mm	69.0160	493.00	591.60
1100 x 900mm	1070-1100mm x 870-900mm	520mm	69.0161	498.00	597.60
1200 x 760mm	1170-1200mm x 730-760mm	450mm	69.0163	502.00	602.40
1200 x 800mm	1170-1200mm x 770-800mm	470mm	69.0028	449.00	538.80
1200 x 900mm	1170-1200mm x 870-900mm	520mm	69.0029	460.00	552.00
1300 x 760mm	1270-1300mm x 730-760mm	450mm	69.162	461.00	553.20
1300 x 800mm	1270-1300mm x 770-800mm	470mm	69.161	487.00	584.40
1400 x 760mm	1370-1400mm x 730-760mm	450mm	69.164	498.00	597.60
1400 x 800mm	1370-1400mm x 770-800mm	470mm	69.163	524.00	628.80

Offset Quadrant reversible left hand or right hand.

This product requires trays with 550mm radius curve. See pages 478-479



Runners release for ease of cleaning

Vantage offset quadrant, 6mm tempered glass, 1850mm high.

FEATURES

- 10 Year manufacturer's guarantee*
 - Easy clean glass
 - Suitable for power showers
 - Trays available to match
 - 6mm Tempered safety glass
 - Polished silver
- *With conditions

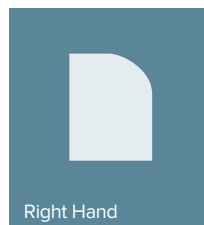

Right Hand

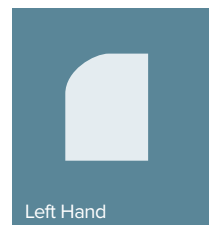

Left Hand

VANTAGE BI-FOLD DOOR

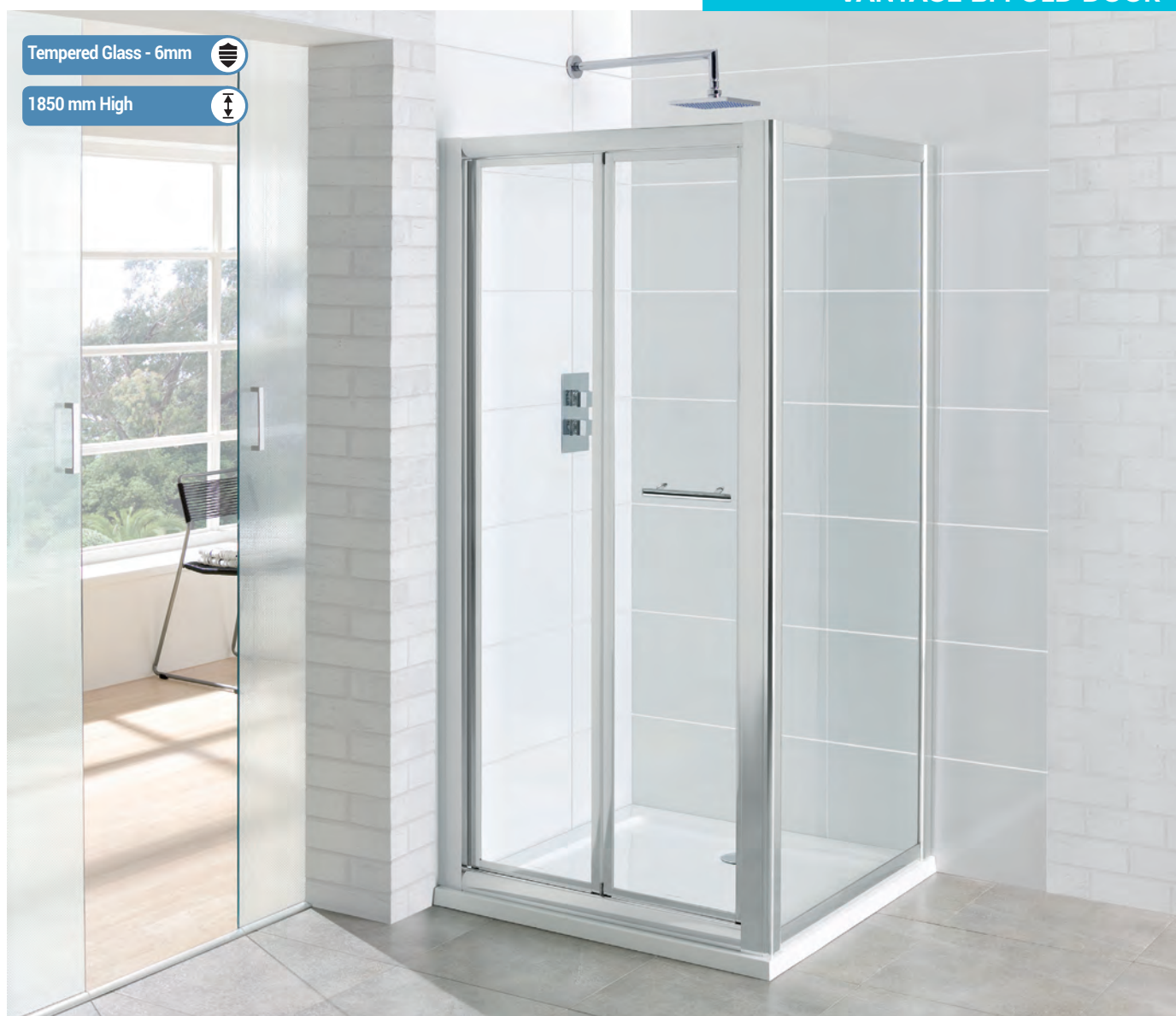

DOORS

Vantage Bi-Fold Door

Size	Adjustment	Door Opening	Code	£ Ex VAT	£ Inc VAT
700mm door	670mm-700mm	395mm	69.0111	385.00	462.00
760mm door	730mm-760mm	455mm	69.0112	387.00	464.40
800mm door	770mm-800mm	495mm	69.0113	391.00	469.20
900mm door	870mm-900mm	595mm	69.0114	395.00	474.00
1000mm door	970mm-1000mm	695mm	69.0115	514.00	616.80

Adjustment varies when fitted with a side panel

EXTRAS

Vantage Side Panel

Size	Adjustment	Code	£ Ex VAT	£ Inc VAT
700mm Side panel	685mm-700mm	69.0092	223.00	267.60
760mm Side panel	745mm-760mm	69.0093	227.00	272.40
800mm Side panel	785mm-800mm	69.0094	233.00	279.60
900mm Side panel	885mm-900mm	69.0095	238.00	285.60
1000mm Side panel	985mm-1000mm	69.0100	243.00	291.60

Side Panel with Towel Rail

Size	Adjustment	Code	£ Ex VAT	£ Inc VAT
700mm Side panel with rail	685mm-700mm	69.0096	270.00	324.00
760mm Side panel with rail	745mm-760mm	69.0097	271.00	325.20
800mm Side panel with rail	785mm-800mm	69.0098	272.00	326.40
900mm Side panel with rail	885mm-900mm	69.0099	279.00	334.80



Vantage bi-fold door, 6mm tempered glass, 1850mm high.

FEATURES

- 10 Year manufacturer's guarantee*
 - Easy clean glass
 - Suitable for power showers
 - Trays available to match
 - 6mm Tempered safety glass
 - Polished silver
- *With conditions

Corniche

CORNICHE SLIDER DOOR

Tempered Glass - 8mm



1950 mm High



DOORS

Corniche Slider Door

Size	Adjustment	Door Opening	Code	£ Ex VAT	£ Inc VAT
1000 Slider	960-1000mm	395mm	69.0075	495.00	594.00
1100 Slider	1060-1100mm	445mm	69.0076	504.00	604.80
1200 Slider	1160-1200mm	485mm	69.0077	518.00	621.60
1200 Slider, easy-clean, soft-close	1160-1200mm	485mm	69.0081	621.00	745.20
1400 Slider	1360-1400mm	510mm	69.0078	575.00	690.00
1600 Slider	1560-1600mm	610mm	69.0079	617.00	740.40
1700 Slider	1660-1700mm	665mm	69.0080	642.00	770.40

EXTRAS

Corniche Side Panel

Size	Adjustment	Code	£ Ex VAT	£ Inc VAT
700 Side Panel	685-700mm	69.0106	272.00	326.40
760 Side Panel	745-760mm	69.0107	283.00	339.60
800 Side Panel	785-800mm	69.0108	294.00	352.80
900 Side Panel	885-900mm	69.0109	315.00	378.00
1000 Side Panel	985-1000mm	69.0110	312.00	374.40
1200 Side Panel	1185-1200mm	69.0138	353.00	423.60

Side Panel with Towel Rail

Size	Adjustment	Code	£ Ex VAT	£ Inc VAT
700 Side Panel with towel rail	685-700mm	69.0101	297.00	356.40
760 Side Panel with towel rail	745-760mm	69.0102	298.00	357.60
800 Side Panel with towel rail	785-800mm	69.0103	300.00	360.00
900 Side Panel with towel rail	885-900mm	69.0104	308.00	369.60
1000 Side Panel with towel rail	985-1000mm	69.0105	342.00	410.40



Runners release for ease of cleaning

Corniche sliding door, 1950mm high with 8mm tempered safety glass doors. (BS EN12150)

FEATURES

- 10 Year manufacturer's guarantee*
- Easy clean glass
- Top cover cap
- Magnetic closing
- Suitable for power showers
- 8mm Tempered safety glass
- Soft close system available on the 1200 door
- Polished silver

*With conditions

CORNICHE HINGE DOOR



Tempered Glass - 8mm



1950 mm High



Corniche hinge door, 1950mm high with 8mm tempered safety glass doors (BS EN12150)

FEATURES

- 10 Year manufacturer's guarantee*
 - Easy clean glass
 - Top cover cap
 - Suitable for power showers
 - 8mm Tempered safety glass
 - Polished silver
- *With conditions

DOORS

Corniche Hinge Door

Size	Adjustment	Door Opening	Code	£ Ex VAT	£ Inc VAT
700 Hinge Door	660-700mm	540mm	69.0087	527.00	632.40
760 Hinge Door	720-760mm	600mm	69.0088	535.00	642.00
800 Hinge Door	760-800mm	640mm	69.0089	541.00	649.20
900 Hinge Door	860-900mm	740mm	69.0090	563.00	675.60
1000 Hinge Door	960-1000mm	840mm	69.0091	576.00	691.20

EXTRAS

Corniche Side Panel

Size	Adjustment	Code	£ Ex VAT	£ Inc VAT
700 Side Panel	685-700mm	69.0106	272.00	326.40
760 Side Panel	745-760mm	69.0107	283.00	339.60
800 Side Panel	785-800mm	69.0108	294.00	352.80
900 Side Panel	885-900mm	69.0109	315.00	378.00
1000 Side Panel	985-1000mm	69.0110	312.00	374.40
1200 Side Panel	1185-1200mm	69.0138	353.00	423.60

Side Panel with Towel Rail

Size	Adjustment	Code	£ Ex VAT	£ Inc VAT
700 Side Panel with towel rail	685-700mm	69.0101	297.00	356.40
760 Side Panel with towel rail	745-760mm	69.0102	298.00	357.60
800 Side Panel with towel rail	785-800mm	69.0103	300.00	360.00
900 Side Panel with towel rail	885-900mm	69.0104	308.00	369.60
1000 Side Panel with towel rail	985-1000mm	69.0105	342.00	410.40

Corniche

CORNICHE QUADRANT

Tempered Glass - 8mm



1950 mm High



Corniche Quadrant, 1950mm high with 8mm tempered safety glass doors. (BS EN12150)

FEATURES

- 10 Year manufacturer's guarantee*
- Easy clean glass
- Top cover cap
- Magnetic closing
- Suitable for power showers
- 8mm Tempered safety glass
- Polished silver
- *With conditions



Runners release for ease of cleaning

DOORS

Corniche Quadrant

Size	Adjustment	Door Opening	Code	£ Ex VAT	£ Inc VAT
800 Quadrant	765-800mm	375mm	69.0059	646.00	775.20
900 Quadrant	865-900mm	510mm	69.0060	679.00	814.80
1000 Quadrant	965-1000mm	510mm	69.0061	718.00	861.60

CORNICHE OFFSET QUADRANT



Corniche Offset Quadrant, illustrated with Volente shower tray (see page 479). 1950mm high with 8mm tempered safety glass doors. (BS EN12150)

FEATURES

- 10 Year manufacturer's guarantee*
 - Easy clean glass
 - Top cover cap
 - Magnetic closing
 - Suitable for power showers
 - 8mm Tempered safety glass
 - Polished silver
- *With conditions



Right Hand



Left Hand

DOORS**Corniche Offset Quadrant**

Size	Adjustment	Door Opening	Code	£ Ex VAT	£ Inc VAT
900 x 760mm	870-900mm x 730-760mm	410mm	69.0062	644.00	772.80
900 x 800mm	870-900mm x 770-800mm	460mm	69.0063	654.00	784.80
1000 x 760mm	970-1000mm x 730-760mm	445mm	69.0064	654.00	784.80
1000 x 800mm	970-1000mm x 770-800mm	470mm	69.0065	672.00	806.40
1000 x 900mm	970-1000mm x 870-900mm	460mm	69.0066	690.00	828.00
1200 x 800mm	1170-1200mm x 770-800mm	470mm	69.0067	705.00	846.00
1200 x 900mm	1170-1200mm x 870-900mm	460mm	69.0068	723.00	867.60



Runners release for ease of cleaning

Vanguard

VANGUARD SLIDER

Tempered Glass - 10mm 

2000 mm High 



VANGUARD SLIDER



N.B. When using a side panel the door must be fitted so that it closes against the side panel as shown above.

DOORS

Vanguard Slider

Size	Adjustment	Door Opening	Code	£ Ex VAT	£ Inc VAT
1000mm door	980-1000mm	380mm	58.250	774.00	928.80
1100mm door	1080-1100mm	420mm	58.251	791.00	949.20
1200mm door	1180-1200mm	460mm	58.252	809.00	970.80
1400mm door	1380-1400mm	540mm	58.253	828.00	993.60
1600mm door	1580-1600mm	620mm	58.254	865.00	1038.00
1700mm door	1680-1700mm	660mm	58.255	907.00	1088.40

EXTRAS

Vanguard Side Panel

Size	Adjustment	Code	£ Ex VAT	£ Inc VAT
700mm side panel	680-700mm	58.262	314.00	376.80
760mm side panel	740-760mm	58.263	324.00	388.80
800mm side panel	780-800mm	58.264	335.00	402.00
900mm side panel	880-900mm	58.265	356.00	427.20
1000mm side panel	980-1000mm	58.266	383.00	459.60

Luxurious, easy to clean enclosure with a distinctive top roller mechanism making a bold statement in your bathroom. 10mm tempered safety glass, 2000mm height.

FEATURES

- 10 Year manufacturer's guarantee*
 - Easy clean glass
 - Trays available to match
 - 10mm Tempered safety glass
 - Polished silver
- *With conditions

Vanguard

VANGUARD QUAD

Tempered Glass - 10mm 

2000 mm High 



Door opening as illustrated only.

DOORS

Vanguard Quadrant

Size	Adjustment	Door Opening	Code	£ Ex VAT	£ Inc VAT
800mm quad	780-800mm	430mm	58.256	901.00	1081.20
900mm quad	880-900mm	470mm	58.257	919.00	1102.80
1000mm quad	980-1000mm	470mm	58.258	984.00	1180.80

Luxurious, easy to clean enclosure with a distinctive top roller mechanism making a bold statement in your bathroom.
10mm tempered safety glass, 2000mm height.

FEATURES

- 10 Year manufacturer's guarantee*
- Easy clean glass
- Trays available to match
- 10mm Tempered safety glass
- Polished silver

*With conditions

VANGUARD OFFSET QUADRANT



Door opening as illustrated only. Enclosure available in left or right hand. Right hand shown above.

Luxurious, easy to clean enclosure with a distinctive top roller mechanism making a bold statement in your bathroom. 10mm tempered safety glass, 2000mm height.

FEATURES

- 10 Year manufacturer's guarantee*
- Easy clean glass
- Trays available to match
- 10mm Tempered safety glass
- Polished silver
- *With conditions



Left hand shown above

DOORS

Vanguard Offset Quadrant

Size	Adjustment	Door Opening	Code	£ Ex VAT	£ Inc VAT
800 x 1000mm quad	780-800 x 980-1000mm	430mm	58.259L or R	960.00	1152.00
800 x 1200mm quad	780-800 x 1180-1200mm	430mm	58.260L or R	993.00	1191.60
900 x 1200mm quad	880-900 x 1180-1200mm	454mm	58.261L or R	1001.00	1201.20

Valliant Walk-In

Tempered Glass - 8mm 

1950 mm High 

VALLIANT - TYPE A

Type A panels are fixed to the wall with a wall profile, the panel also comes with one wall support bar.

FEATURES

- 10 Year manufacturer's guarantee*
- Easy clean glass
- 1950mm Height
- Trays available to match
- 8mm Tempered safety glass
- *With conditions

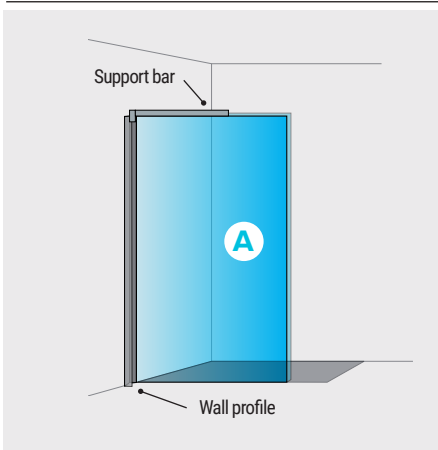

Panel A
Comes with 1 wall profile and 1 support bar.

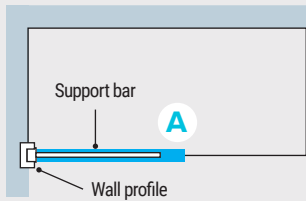

Panel A - Example
58.356 800mm side panel including support bar and wall profile (A) See page 458 for details.

VALLIANT - TYPE B

Type B panels can only be used in a walk-through situation, the panel is a single pane of glass and comes with two wall support bars only. This can be used with two type C, 250mm panels, which contain a corner profile so they can be attached to the Type B panel. They can both be installed with a tray or in a wetroom situation.

FEATURES

- 10 Year manufacturer's guarantee*
- Easy clean glass
- 1950mm Height
- Trays available to match
- 8mm Tempered safety glass
- *With conditions

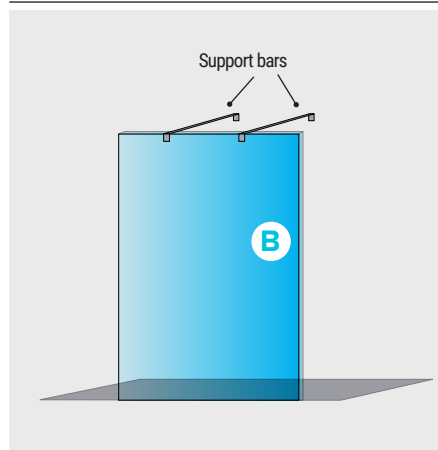

Panel B - Comes with 2 support bars. (No wall profile supplied).

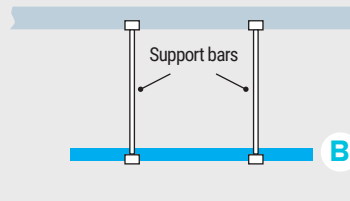

Panel B - Example
58.362 1200mm walk-in panel with two support bars (B), see page 458 for details.

VALLIANT - TYPE C

Type C is a single pane of glass with a corner profile, this can only be attached to another pane of glass (no wall support bar is provided with Type C). Type A/B & C can be used together to create different walk-in situations as illustrated, see page opposite and below. However please note the wall support bar from Type A/B can be used on either pane of glass to suit your requirements.

FEATURES

- 10 Year manufacturer's guarantee*
- 1950mm Height
- Easy clean glass
- 8mm Tempered safety glass
- *With conditions

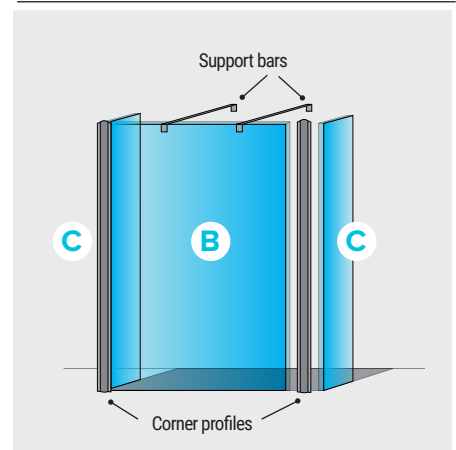

Panel C - Comes with 1 corner profile (No wall profile supplied), shown with Type B panel.

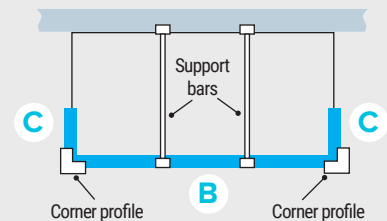

Panel C - Example
58.362 1200mm walk-in panel with two support bars (B), 2 x 58.363 250mm end panels (C), see page 458 for details.

Valliant Walk-In

VALLIANT - TYPE D

Type D contains a panel of glass with a wall profile, plus a 300mm flipper which is hinged and rotates 180 degrees. Type D must be fixed to the wall, it cannot be fixed to another pane of glass.

FEATURES

- 10 Year manufacturer's guarantee*
- Easy clean glass
- 1950mm Height
- Trays available to match
- 8mm Tempered safety glass
- *With conditions

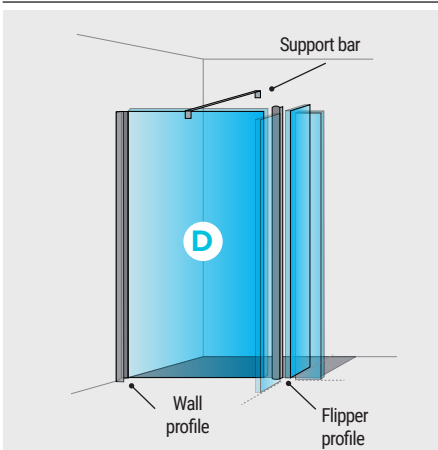

Panel C - Comes with 1 wall profile, support bar and a 300mm flipper.

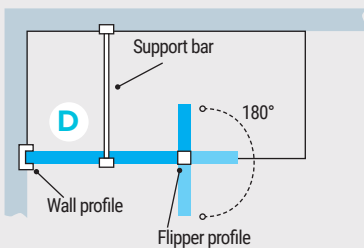

Panel C - Example
58.351 800mm front panel with wall profile and 300mm flipper (D), see page 460 for details.

OTHER VALLIANT COMBINATIONS

TYPE A & C

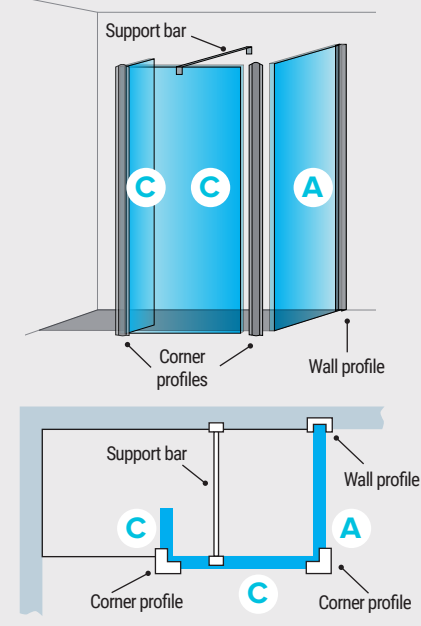

See page 461 for details.

TYPE A & C

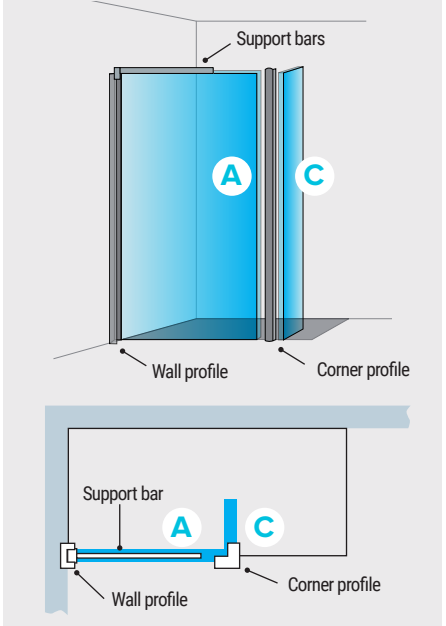

See page 461 for details.

TYPE A & C

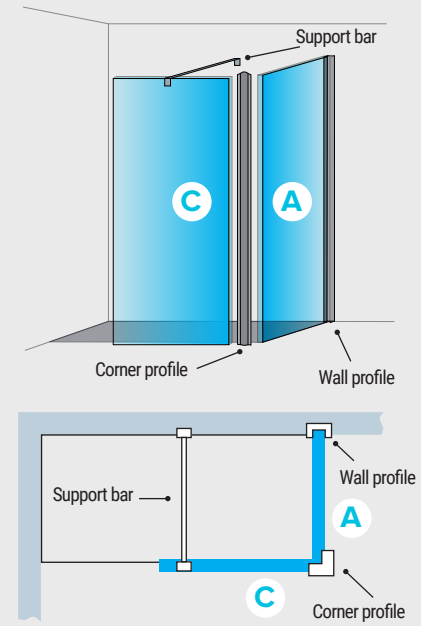

See page 461 for details.

TYPE A & D

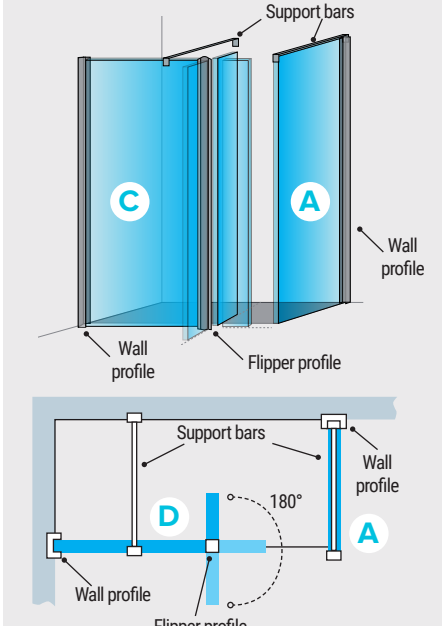

TYPE A

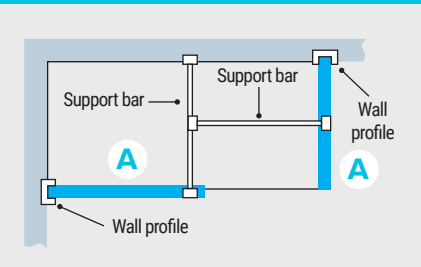

See page 458 for details.

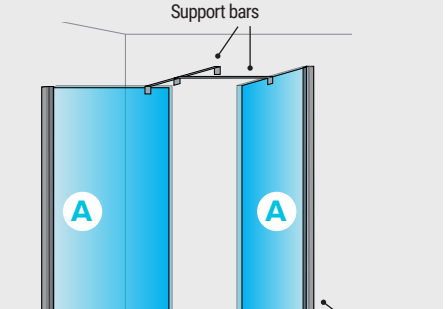

Valliant Walk-In

VALLIANT - TYPE A

Tempered Glass - 8mm



1950 mm High



Application 1

58.356 800mm side panel including support bar and wall profile (A)



Application 2

2 x 58.357 900mm side panel including support bar and wall profile (A)

Valliant Walk-in - Type A

Size	Includes	Adjustment	Type	Code	£ Ex VAT	£ Inc VAT
300x1950 (8mm)	support bar	282-300mm	A	58.103	212.00	254.40
500x1950 (8mm)	support bar	482-500mm	A	58.689	234.00	280.80
700x1950 (8mm)	support bar	662-680mm	A	58.354	314.00	376.80
760x1950 (8mm)	support bar	722-740mm	A	58.355	320.00	384.00
800x1950 (8mm)	support bar	762-780mm	A	58.356	324.00	388.80
900x1950 (8mm)	support bar	862-880mm	A	58.357	346.00	415.20
1000x1950 (8mm)	support bar	962-980mm	A	58.358	367.00	440.40
1100x1950 (8mm)	support bar	1062-1080mm	A	58.046	369.00	442.80
1200x1950 (8mm)	support bar	1162-1180mm	A	58.047	388.00	465.60
1450x1950 (8mm)	support bar	1362-1380mm	A	58.048	429.00	514.80

Type A panels are fixed to the wall with a wall profile, the panel also comes with one wall support bar. A 300mm flipper kit can be installed retrospectively.

FEATURES

- 10 Year manufacturer's guarantee*
- Easy clean glass
- 1950mm Height
- Trays available to match
- 8mm Tempered safety glass
- *With conditions

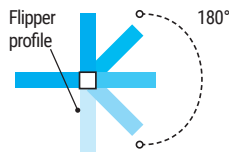

300mm Flipper kit can be added to any Valliant glass to convert to a flipper (see page 461).

Panel A

Comes with 1 wall profile and 1 support bar.

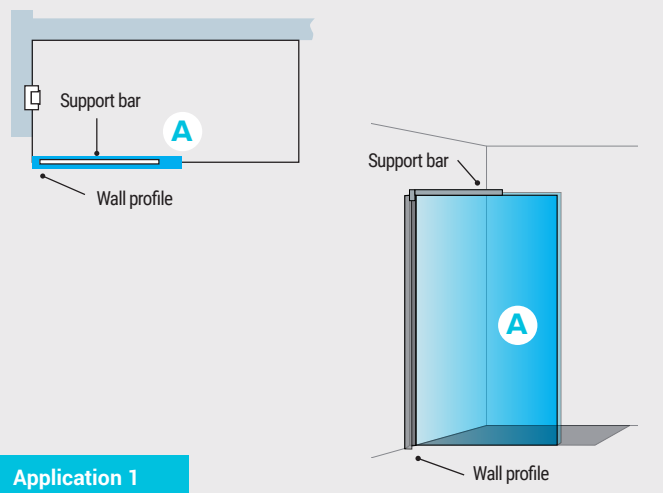

Application 1

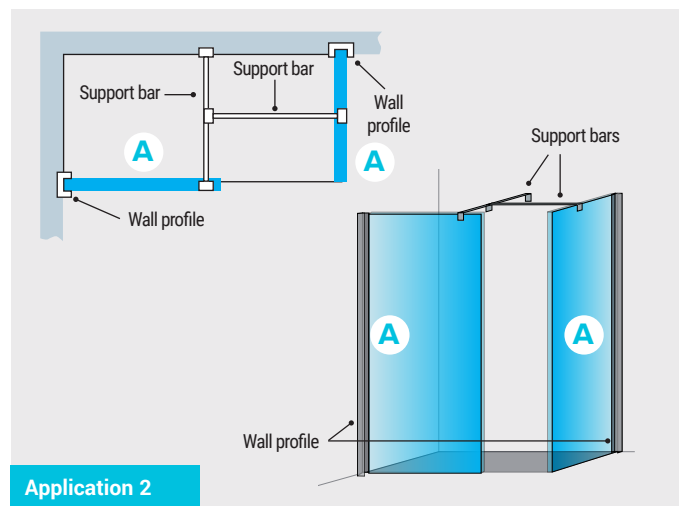

Application 2

Valliant Walk-In

VALLIANT - TYPE B

Tempered Glass - 8mm



1950 mm High



58.362 1200mm walk-in panel with two support bars (B)

Type B panels can only be used in a walk-through situation, the panel is a single pane of glass and comes with two wall support bars only. This can be used with two type C, 250mm panels, which contain a corner profile so they can be attached to the Type B panel or with the flipper kit, to create a 180 degree flipper panel. They can both be installed with a tray or in a wetroom situation.

FEATURES

- 10 Year manufacturer's guarantee*
- Easy clean glass
- 1950mm Height
- Trays available to match
- 8mm Tempered safety glass
- *With conditions

Valliant Walk-in - Type B

Size	Includes	Glass Length	Type	Code	£ Ex VAT	£ Inc VAT
900x1950 (8mm)	2 x support bars	860mm	B	58.359	340.00	408.00
1000x1950 (8mm)	2 x support bars	960mm	B	58.360	359.00	430.80
1100x1950 (8mm)	2 x support bars	1060mm	B	58.361	380.00	456.00
1200x1950 (8mm)	2 x support bars	1160mm	B	58.362	401.00	481.20

Flipper kit can be installed retrospectively.

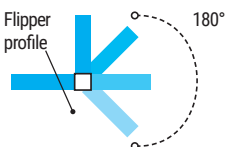

300mm Flipper kit can be added to any Valliant glass to convert to a flipper (see page 461).

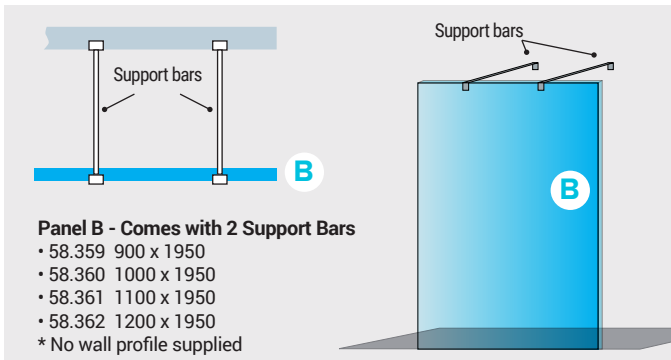

VALLIANT - TYPE C

Tempered Glass - 8mm



1950 mm High



Combination B&C

58.362 1200mm walk-in panel with two support bars (B), 2 x 58.363 250mm end panels (C)

Type C is a single pane of glass with a corner profile, this can only be attached to another pane of glass (no wall support bar is provided with Type C). Type A & C can be used together to create different walk-in situations as illustrated. However please note the wall support bar from Type A can be used on either pane of glass to suit your requirements.

Valliant Walk-in - Type C**

Description	Type	Code	£ Ex VAT	£ Inc VAT
Valliant walkin 250x1950 C 8mm*	C	58.363	257.00	308.40
Valliant walkin support bar 900mm*	-	58.369	49.00	58.80
Valliant Flipper Kit 1950 x 300*	-	58.044	96.00	115.20
Volente/Valliant ceiling support bar*	-	58.816	77.00	92.40

300mm Flipper kit can be added to any Valliant glass to convert to a flipper.

**No support bar supplied. *Panel C comes with one corner profile. No wall profile supplied.

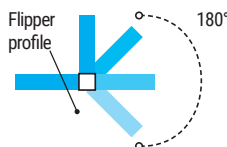

300mm Flipper kit can be added to any Valliant glass to convert to a flipper (see page 461).

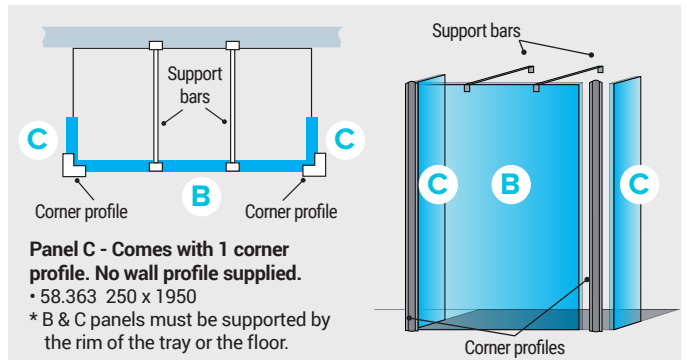

Valliant Walk-In

VALLIANT - TYPE D



Tempered Glass - 8mm
1950 mm High

58.351 800mm front panel with wall profile and 300mm flipper (D)

Type D contains a panel of glass with a wall profile, plus a 300mm flipper which is hinged and rotates 180 degrees. Type D must be fixed to the wall, it cannot be fixed to another pane of glass.

FEATURES

- 10 Year manufacturer's guarantee*
 - 1950mm Height
 - Trays available to match
 - 8mm Tempered safety glass
- *With conditions

Valliant Walk-in - Type D

Size	Includes	Adjustment	Type	Code	£ Ex VAT	£ Inc VAT
600x1950 (8mm)	300 Flipper	582-600mm	D	58.350	392.00	470.40
800x1950 (8mm)	300 Flipper	782-800mm	D	58.351	435.00	522.00
900x1950 (8mm)	300 Flipper	882-900mm	D	58.352	456.00	547.20
1100x1950 (8mm)	300 Flipper	1082-1100mm	D	58.353	497.00	470.40
1200x1950 (8mm)	300 Flipper	1182-1200mm	D	58.690	509.00	610.80

Accessories

Size	Code	£ Ex VAT	£ Inc VAT
Valliant walkin support bar 9mm	58.369	49.00	58.80
Valliant flipper kit 1950x300	58.044	96.00	115.20
Valliant flipper kit 1950x400	58.819	121.00	145.20
Volente/Valliant ceiling support bar	58.816	77.00	92.40

300/400mm Flipper kit can be added to any Valliant glass to convert to a flipper.

Panel D

Comes with 1 wall profile, support bar and a 300mm flipper.

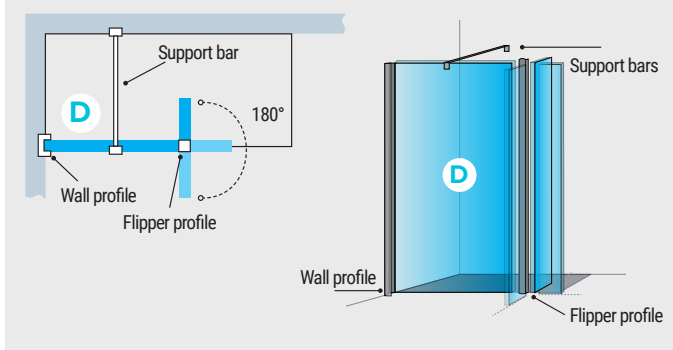

VALLIANT - TYPE A&D



Tempered Glass - 8mm
1950 mm High

58.357 900mm side panel including support bar and wall profile (A), 58.351 800mm front panel with wall profile and 300mm flipper (D)

Type A panels are fixed to the wall with a wall profile, the panel also comes with a wall support bar and are shown here as end panels. Type D contains a panel of glass with a wall profile, plus a 300mm flipper which is hinged and rotates 180 degrees. Type D must be fixed to the wall and it cannot be fixed to another pane of glass.

Valliant Walk-in - Type A

Size	Includes	Adjustment	Type	Code	£ Ex VAT	£ Inc VAT
300x1950 (8mm)	support bar	282-300mm	A	58.103	212.00	254.40
500x1950 (8mm)	support bar	482-500mm	A	58.689	234.00	280.80
700x1950 (8mm)	support bar	662-680mm	A	58.354	314.00	376.80
760x1950 (8mm)	support bar	722-740mm	A	58.355	320.00	384.00
800x1950 (8mm)	support bar	762-780mm	A	58.356	324.00	388.80
900x1950 (8mm)	support bar	862-880mm	A	58.357	346.00	415.20
1000x1950 (8mm)	support bar	962-980mm	A	58.358	367.00	440.40
1100x1950 (8mm)	support bar	1062-1080mm	A	58.046	369.00	442.80
1200x1950 (8mm)	support bar	1162-1180mm	A	58.047	388.00	465.60
1400x1950 (8mm)	support bar	1362-1380mm	A	58.048	429.00	514.80

Valliant Walk-in - Type D

Size	Includes	Adjustment	Type	Code	£ Ex VAT	£ Inc VAT
600x1950 (8mm)	300 Flipper	582-600mm	D	58.350	392.00	470.40
800x1950 (8mm)	300 Flipper	782-800mm	D	58.351	435.00	522.00
900x1950 (8mm)	300 Flipper	882-900mm	D	58.352	456.00	547.20
1100x1950 (8mm)	300 Flipper	1082-1100mm	D	58.353	497.00	470.40
1200x1950 (8mm)	300 Flipper	1182-1200mm	D	58.690	509.00	610.80

Panel A

Comes with 1 wall profile and 1 support bar.

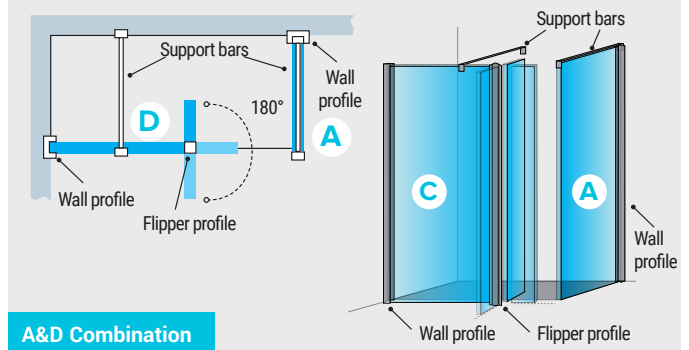

A&D Combination

Valliant Walk-In

VALLIANT - TYPE A&C - COMBINATIONS



Tempered Glass - 8mm



1950 mm High



Application 1

58.357 900mm side panel including support bar and wall profile (A), 58.367 900mm end panel with corner profile (C)



Tempered Glass - 8mm



1950 mm High



Application 2

58.367 900mm end panel with corner profile (C), 2 x 58.357 900mm side panel including support bar and wall profile (A)

Type C is a single pane of glass with a corner profile, this can only be attached to another pane of glass (no wall support bar is provided with Type C). Type A & C can be used together to create different walk-in situations as illustrated, can also install a 180 degree flipper kit retrospectively. However please note the wall support bar from Type A can be used on either pane of glass to suit your requirements.

Valliant Walk-in - Type C

Size	Includes	Glass Length	Type	Code	£ Ex VAT	£ Inc VAT
250x1950 (8mm)	Corner Profile	250mm	C*	58.363	257.00	308.40
700x1950 (8mm)	Corner Profile	650mm	C*	58.364	272.00	326.40
760x1950 (8mm)	Corner Profile	710mm	C*	58.365	278.00	333.60
800x1950 (8mm)	Corner Profile	750mm	C*	58.366	282.00	338.40
900x1950 (8mm)	Corner Profile	850mm	C*	58.367	304.00	364.80
1000x1950 (8mm)	Corner Profile	950mm	C*	58.368	323.00	387.60

*No wall support bar is provided with Type C

Accessories

Size	Code	£ Ex VAT	£ Inc VAT
Valliant walkin support bar 9mm	58.369	49.00	58.80
Valliant flipper kit 1950x300	58.044	96.00	115.20
Valliant flipper kit 1950x400	58.819	121.00	145.20
Volente/Valliant ceiling support bar	58.816	77.00	92.40

Valliant Walk-in - Type A

Size	Includes	Adjustment	Type	Code	£ Ex VAT	£ Inc VAT
300x1950 (8mm)	support bar	282-300mm	A	58.103	212.00	254.40
500x1950 (8mm)	support bar	482-500mm	A	58.689	234.00	280.80
700x1950 (8mm)	support bar	662-680mm	A	58.354	314.00	376.80
760x1950 (8mm)	support bar	722-740mm	A	58.355	320.00	384.00
800x1950 (8mm)	support bar	762-780mm	A	58.356	324.00	388.80
900x1950 (8mm)	support bar	862-880mm	A	58.357	346.00	415.20
1000x1950 (8mm)	support bar	962-980mm	A	58.358	367.00	440.40
1100x1950 (8mm)	support bar	1062-1080mm	A	58.046	369.00	442.80
1200x1950 (8mm)	support bar	1162-1180mm	A	58.047	388.00	465.60
1400x1950 (8mm)	support bar	1362-1380mm	A	58.048	429.00	514.80

Valliant Walk-in - Type C

Size	Includes	Glass Length	Type	Code	£ Ex VAT	£ Inc VAT
250x1950 (8mm)	Corner Profile	250mm	C*	58.363	257.00	308.40
700x1950 (8mm)	Corner Profile	650mm	C*	58.364	272.00	326.40
760x1950 (8mm)	Corner Profile	710mm	C*	58.365	278.00	333.60
800x1950 (8mm)	Corner Profile	750mm	C*	58.366	282.00	338.40
900x1950 (8mm)	Corner Profile	850mm	C*	58.367	304.00	364.80
1000x1950 (8mm)	Corner Profile	950mm	C*	58.368	323.00	387.60

*No wall support bar is provided with Type C

These panels must be supported by the rim of the tray or the floor

Panel C

Comes with 1 corner profile.

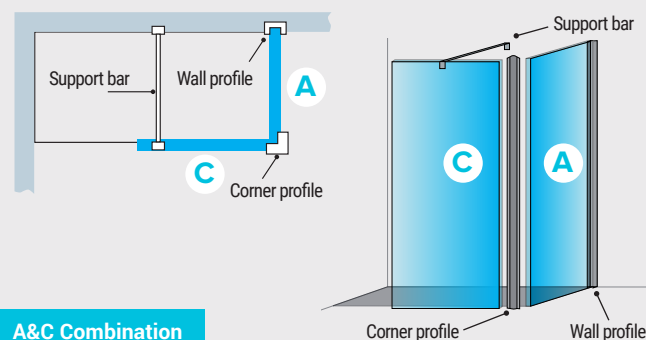

A&C Combination

Panel A

Comes with 1 wall profile and 1 support bar.

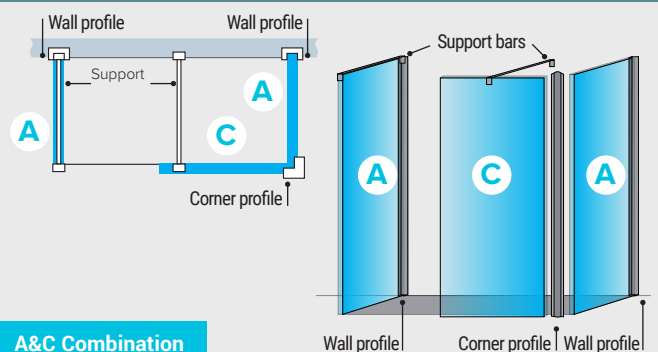

A&C Combination

Valliant Walk-In

VALLIANT - TYPE A&C - COMBINATION

Tempered Glass - 8mm 

1950 mm High 



Application 3

58.357 900mm side panel including support bar and wall profile (A), 58.363 250mm end panel with corner profile (C)

Type A panels are fixed to the wall with a wall profile, the panel also comes with one wall support bar. Type C is a single pane of glass with a corner profile, this can only be attached to another pane of glass (no support bar is provided with Type C). Type A & C can be used together to create different walk-in situations as illustrated - and can also be installed with a 180 degree flipper kit retrospectively. However please note the wall support bar from Type A can be used on either pane of glass to suit your requirements.

Valliant Walk-in - Type A						
Size	Includes	Adjustment	Type	Code	£ Ex VAT	£ Inc VAT
300x1950 (8mm)	support bar	282-300mm	A	58.103	212.00	254.40
500x1950 (8mm)	support bar	482-500mm	A	58.689	234.00	280.80
700x1950 (8mm)	support bar	662-680mm	A	58.354	314.00	376.80
760x1950 (8mm)	support bar	722-740mm	A	58.355	320.00	384.00
800x1950 (8mm)	support bar	762-780mm	A	58.356	324.00	388.80
900x1950 (8mm)	support bar	862-880mm	A	58.357	346.00	415.20
1000x1950 (8mm)	support bar	962-980mm	A	58.358	367.00	440.40
1100x1950 (8mm)	support bar	1062-1080mm	A	58.046	369.00	442.80
1200x1950 (8mm)	support bar	1162-1180mm	A	58.047	388.00	465.60
1400x1950 (8mm)	support bar	1362-1380mm	A	58.048	429.00	514.80

Valliant Walk-in - Type C						
Size	Includes	Glass Length	Type	Code	£ Ex VAT	£ Inc VAT
250x1950 (8mm)	Corner Profile	250mm	C*	58.363	257.00	308.40
700x1950 (8mm)	Corner Profile	650mm	C*	58.364	272.00	326.40
760x1950 (8mm)	Corner Profile	710mm	C*	58.365	278.00	333.60
800x1950 (8mm)	Corner Profile	750mm	C*	58.366	282.00	338.40
900x1950 (8mm)	Corner Profile	850mm	C*	58.367	304.00	364.80
1000x1950 (8mm)	Corner Profile	950mm	C*	58.368	323.00	387.60

*No wall support bar is provided with Type C
These panels must be supported by the rim of the tray or the floor

Accessories			
Size	Code	£ Ex VAT	£ Inc VAT
Valliant walkin support bar 900mm	58.369	49.00	58.80
Valliant Flipper Kit 1950 x 300	58.044	96.00	115.20
Valliant Flipper Kit 1950 x 400	58.819	121.00	145.20
Volente/Valliant ceiling support bar	58.816	77.00	92.40

300/400mm Flipper kit can be added to any Valliant glass to convert to a flipper at time of installation or retrospectively. N.B 58.816 Ceiling support arm is 580mm in length and can be cut down.

Panel A
Comes with 1 wall profile and 1 support bar.

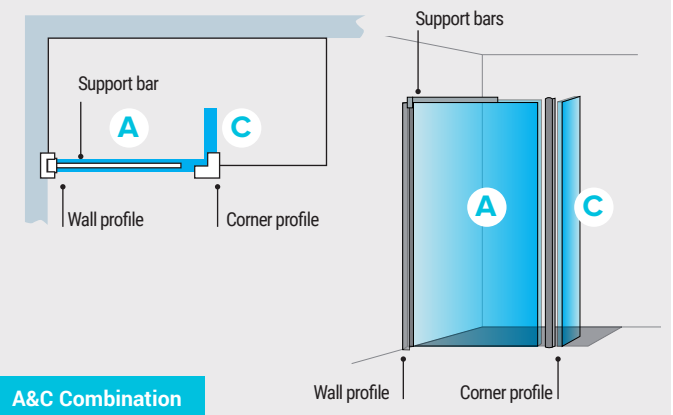

A&C Combination

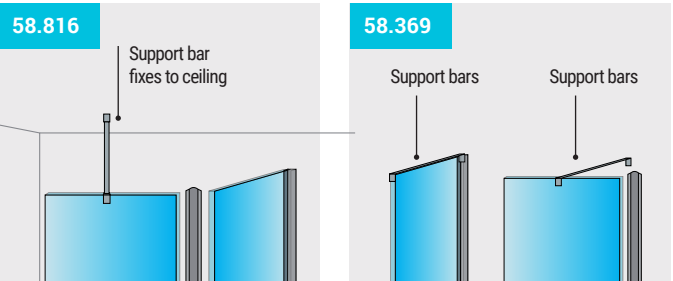

A new range of accessories for the Valliant Walk-ins includes a wall support bar which fixes directly to the wall, a 300mm and 400mm Flipper kit which can be added to any Valliant glass panel to convert to a flipper, and a ceiling support bar which fixes the glass panel to the ceiling.

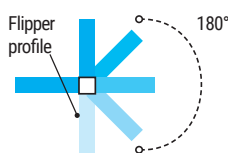

300/400mm Flipper kit can be added to any Valliant glass to convert to a flipper (see page 461).

Volente Walk-In

VOLENTE CURVED WALK-IN

50%
OFF

Tempered Glass - 6mm 

1850 mm High 



DOORS

Volente Curved Walk-In		WAS	NOW JUST	
Size	Code	£ Ex VAT	£ Ex VAT	£ Inc VAT
Volente curved walkin 870 panel for 1400 tray†	58.605	608.00	304.00	364.80
Volente curved walkin 970 panel for 1400 tray†	58.606	643.00	321.00	385.20
Volente 765 end panel for curved walkin†	58.607	251.00	125.00	150.00

†While stocks last

Luxurious, easy to clean, contemporary frameless enclosure in 6mm tempered safety glass, height 1850mm, comes with walk-in support bar.

FEATURES

- 10 Year manufacturer's guarantee*
- Easy clean glass
- Concealed fittings
- 6mm Tempered safety glass
- *With conditions

EXTRAS

Biava Wet Floor System

Description	Code	£ Ex VAT	£ Inc VAT
Biava floor former 1200mm x 900mm inc waste	65.0001	482.00	578.40
Biava floor former 1200mm x 900mm inc vinyl waste	65.1001	579.00	694.80

Floor formers cannot be cut down. See pages 470-471 for further information.

Volente Walk-In

VOLENTE WALK-IN - CLEAR GLASS

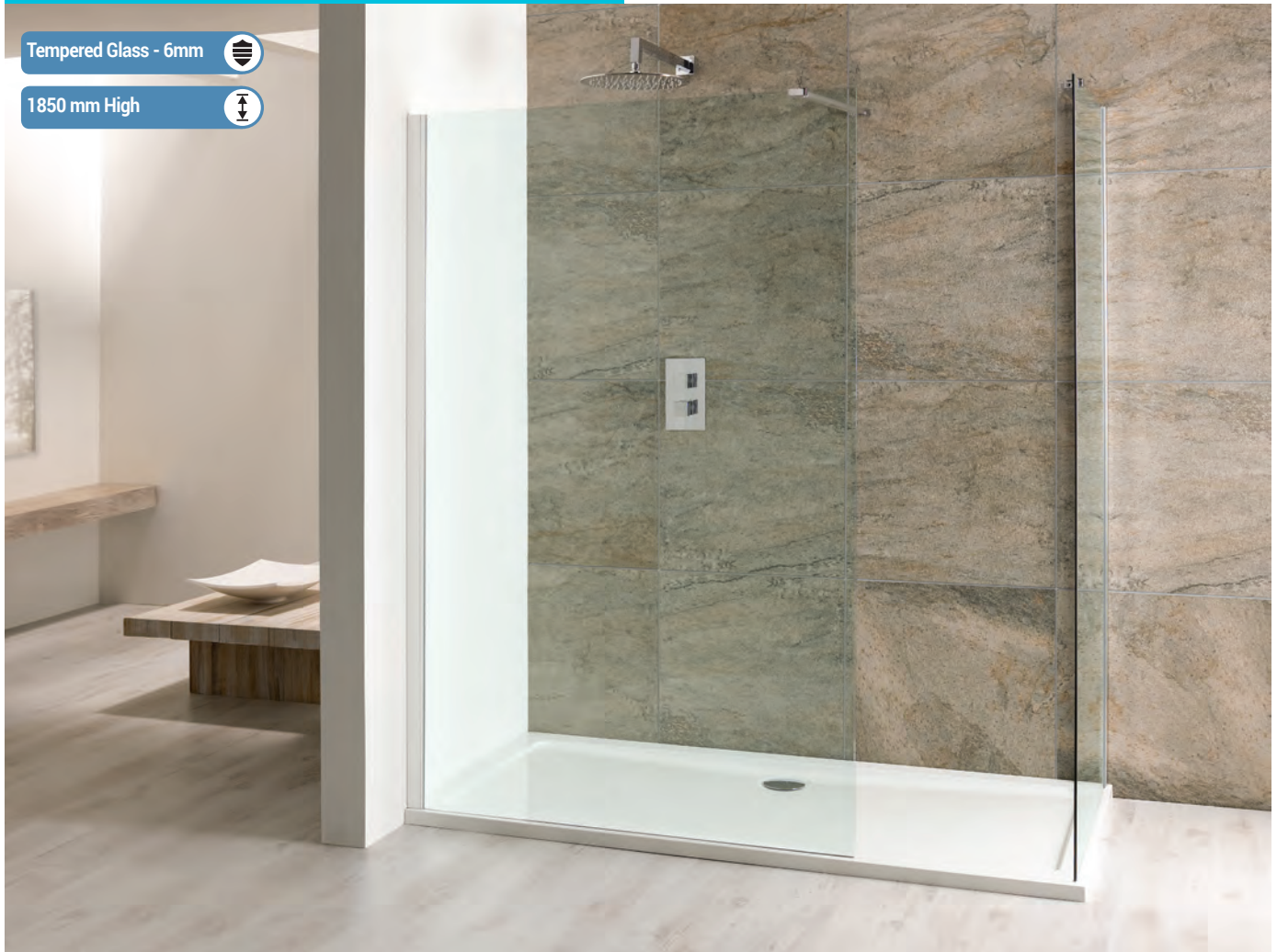

Tempered Glass - 6mm 

1850 mm High 

PANELS

Volente Walk-In - Clear Glass

Size	Adjustment	Code	£ Ex VAT	£ Inc VAT
500mm front panel	472-490mm	58.688	204.00	244.80
700mm front panel	672-690mm	58.614	242.00	290.40
760mm front panel	732-750mm	58.615	242.00	290.40
800mm front panel	772-790mm	58.616	242.00	290.40
900mm front panel	872-890mm	58.611	251.00	301.20
1000mm front panel	972-990mm	58.612	269.00	322.80
1200mm front panel	1172-1190mm	58.613	304.00	364.80

All panels come with one support bar.

EXTRAS

End Panels - Clear Glass

Size	Adjustment	Code	£ Ex VAT	£ Inc VAT
300mm end panel	272-290mm	58.102	188.00	225.60
500mm end panel	472-490mm	58.688	204.00	244.80
700mm end panel	672-690mm	58.614	242.00	290.40
760mm end panel	732-750mm	58.615	242.00	290.40
800mm end panel	772-790mm	58.616	242.00	290.40
900mm end panel	872-890mm	58.611	251.00	301.20

All panels come with one support bar.

Volente Extras

Description	Code	£ Ex VAT	£ Inc VAT
Valliant Walkin support bar 900mm	58.369	49.00	58.80
Volente Flipper Kit 1850 x 300*	58.817	86.00	103.20
Volente Flipper Kit 1850 x 400*	58.818	92.00	110.40
Volente /Valliant ceiling support bar*	58.816	77.00	92.40

Flipper kit can be installed retrospectively.

Luxurious, easy to clean, contemporary framed enclosure in 6mm tempered safety glass, height 1850mm.

FEATURES

- 10 Year manufacturer's guarantee*
- Easy clean glass
- 6mm Tempered safety glass
- Clear glass - also available in frosted glass
- *With conditions

*When fitting with two side panels one of the standard Volente side panels (P418) is used with one of the Volente walk-in end panels. The front panel may have to be downsized to ensure there is enough opening on the walk-in end panels. For further advice please contact our technical department on 01452 317 890.



Note: wall bracket can be fitted at 90° or parallel to the glass.



300mm panel allows greater access





Can be fitted with two side panels as shown*

Volente Walk-In

VOLENTE WALK-IN - FROSTED GLASS



Tempered Glass - 6mm 

1850 mm High 

Frosted 

PANELS

Volente Walk-In - Frosted Glass

Size	Adjustment	Code	£ Ex VAT	£ Inc VAT
500mm front panel	472-490mm	58.036	213.00	255.60
700mm front panel	672-690mm	58.033	234.00	280.80
760mm front panel	732-750mm	58.034	242.00	290.40
800mm front panel	772-790mm	58.035	250.00	300.00
900mm front panel	872-890mm	58.030	261.00	313.20
1000mm front panel	972-990mm	58.031	279.00	334.80
1200mm front panel	1172-1190mm	58.032	317.00	380.40

All panels come with one support bar.

EXTRAS

End Panels - Frosted Glass

Size	Adjustment	Code	£ Ex VAT	£ Inc VAT
300mm end panel	272-290mm	58.029	194.00	232.80
500mm end panel	472-490mm	58.036	213.00	255.60
700mm end panel	672-690mm	58.033	234.00	280.80
760mm end panel	732-750mm	58.034	242.00	290.40
800mm end panel	772-790mm	58.035	250.00	300.00
900mm end panel	872-890mm	58.030	261.00	313.20

All panels come with one support bar.

Luxurious, easy to clean, contemporary framed enclosure in 6mm tempered safety glass, height 1850mm.

FEATURES

- 10 Year manufacturer's guarantee*
- Easy clean glass
- 6mm Tempered safety glass
- Frosted glass - also available in clear glass
- *With conditions

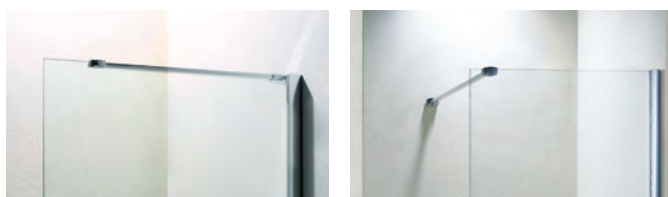

Note: wall bracket can be fitted at 90° or parallel to the glass.

EXTRAS

Volente Extras

Description	Code	£ Ex VAT	£ Inc VAT
Valliant Walkin support bar 900mm	58.369	49.00	58.80
Volente/Valliant ceiling support bar*	58.816	77.00	92.40

Flipper kit can be installed retrospectively.

Corniche Walk-In

CORNICHE WALK-IN

Tempered Glass - 8mm 

1950 mm High 



Corniche walk-in shower with side panel - ideal for alcove situations. 1950mm high with 8mm tempered safety glass (BS EN12150) and a 550mm opening. Front panel comes with wall fixing, end panel comes with connecting bar.

FEATURES

- Easy clean glass
- Top cover cap
- Trays available to match
- 8mm Tempered safety glass
- 10 Year manufacturer's guarantee*
- *With conditions

PANELS

Corniche 8mm Walk-In Panels

Size	Adjustment	Code	£ Ex VAT	£ Inc VAT
850 Front panel for 1400 tray	840-850mm	69.0116	309.00	370.80
950 Front panel for 1500 tray	940-950mm	69.0118	330.00	396.00
1150 Front panel for 1700 tray	1140-1150mm	69.0119	359.00	430.80
End panel for 700	690-700mm	69.0121	265.00	318.00
End panel for 760	750-760mm	69.0122	277.00	332.40
End panel for 800	790-800mm	69.0120	300.00	360.00
End panel for 900	890-900mm	69.0117	320.00	384.00



Vantage Walk-In

VANTAGE FLIPPER WALK-IN



Tempered Glass - 6mm



1950 mm High



These walk-in shower enclosures with hinged flipper panel are suitable for use in an alcove three sided situation without the side panel. They are 6mm tempered safety glass, with a flipper height of 1950mm, and allow a 600mm opening. Will fit all Eastbrook trays of the appropriate size, and can also be used in a wet room situation.

FEATURES

- 10 Year manufacturer's guarantee*
- Easy clean glass
- 8mm Tempered safety glass
- *With conditions

PANELS

Vantage 8mm Walk-In Panels

Size	Adjustment	Code	£ Ex VAT	£ Inc VAT
600mm Front panel with flipper for 1200 tray*	580-600mm	69.0129	451.00	541.20
800mm Front panel with flipper for 1400 tray*	780-800mm	69.0130	477.00	572.40
900mm Front panel with flipper for 1500 tray*	880-900mm	69.0131	495.00	594.00
1100mm Front panel with flipper for 1700 tray*	1080-1100mm	69.0132	525.00	630.00
700mm side panel	680-700mm	69.0135	155.00	186.00
760mm side panel	740-760mm	69.0136	162.00	194.40
800mm side panel	780-800mm	69.0133	239.00	286.80
900mm side panel	880-900mm	69.0134	251.00	301.20



Valliant Walk-In



The Valliant Walk In with ceiling fixing pole. This range does away with the intrusive overhead wall bars and fixes straight up to the ceiling. Shown in a wet room situation but can also be fitted with a shower tray. Suitable for ceiling heights of up to 2500mm. Now available with 300mm flipper.

- FEATURES**
- 10 Year manufacturer's guarantee*
 - 8mm Tempered safety glass
 - Easy clean glass
 - Polished silver
 - *With conditions

Valliant Round Pole Walk-In Panels				
Size	Adjustment	Code	£ Ex VAT	£ Inc VAT
500mm Front panel	490-500mm	69.0047	252.00	302.40
700mm Front panel	690-700mm	69.0048	268.00	321.60
760mm Front panel	750-760mm	69.0049	273.00	327.60
800mm Front panel	790-800mm	69.0050	278.00	333.60
900mm Front panel	890-900mm	69.0051	287.00	344.40
1000mm Front panel	990-1000mm	69.0052	301.00	361.20
1200mm Front panel	1190-1200mm	69.0053	320.00	384.00
1400mm Front panel	1390-1400mm	69.0054	329.00	394.80



PANELS

Valliant Square Pole Walk-In Panels				
Size	Adjustment	Code	£ Ex VAT	£ Inc VAT
500mm Front panel	490-500mm	69.0039	250.00	300.00
700mm Front panel	690-700mm	69.0040	266.00	319.20
760mm Front panel	750-760mm	69.0041	271.00	325.20
800mm Front panel	790-800mm	69.0042	275.00	330.00
900mm Front panel	890-900mm	69.0043	284.00	340.80
1000mm Front panel	990-1000mm	69.0044	294.00	352.80
1200mm Front panel	1190-1200mm	69.0045	318.00	381.60
1400mm Front panel	1390-1400mm	69.0046	325.00	390.00

EXTRAS

Accessories			
Description	Code	£ Ex VAT	£ Inc VAT
Flipper for Straight Square Pole 300 x 1950mm	69.0155	191.00	229.20

Now available with flipper

Valliant Walk-In

VALLIANT ROUND POLE WALK-IN WITH HAND HOLD



FEATURES

- Suitable for ceiling heights of up to 3350mm
 - 8mm tempered safety glass
 - Can be fitted without a tray
 - Easy clean glass
 - 10 year manufacturers guarantee*
- *With conditions

Valliant Round Pole Walk-In with Hand Hold

Size	Adjustment	Code	£ Ex VAT	£ Inc VAT
800mm Valliant	780-800mm	58.831	219.00	262.80
900mm Valliant	880-900mm	58.832	235.00	282.00
1000mm Valliant	980-1000mm	58.833	252.00	302.40
1200mm Valliant	1180-1200mm	58.834	285.00	342.00

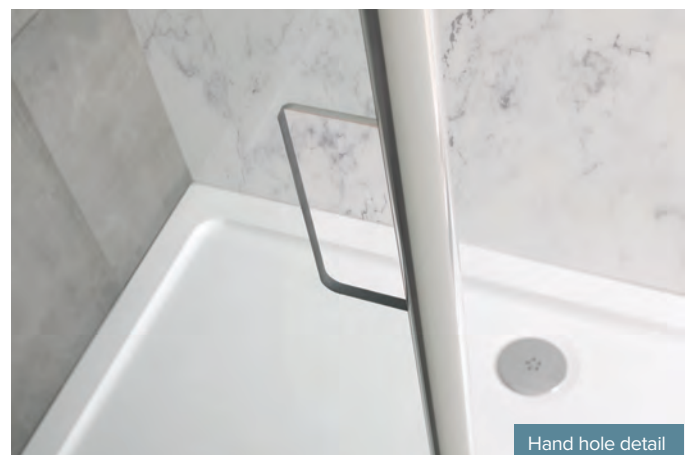

Hand hold detail

Valliant Walk-In

VALLIANT SQUARE POLE WALK-IN OFFSET

Tempered Glass - 6mm 

1850 mm High 



Now available with flipper

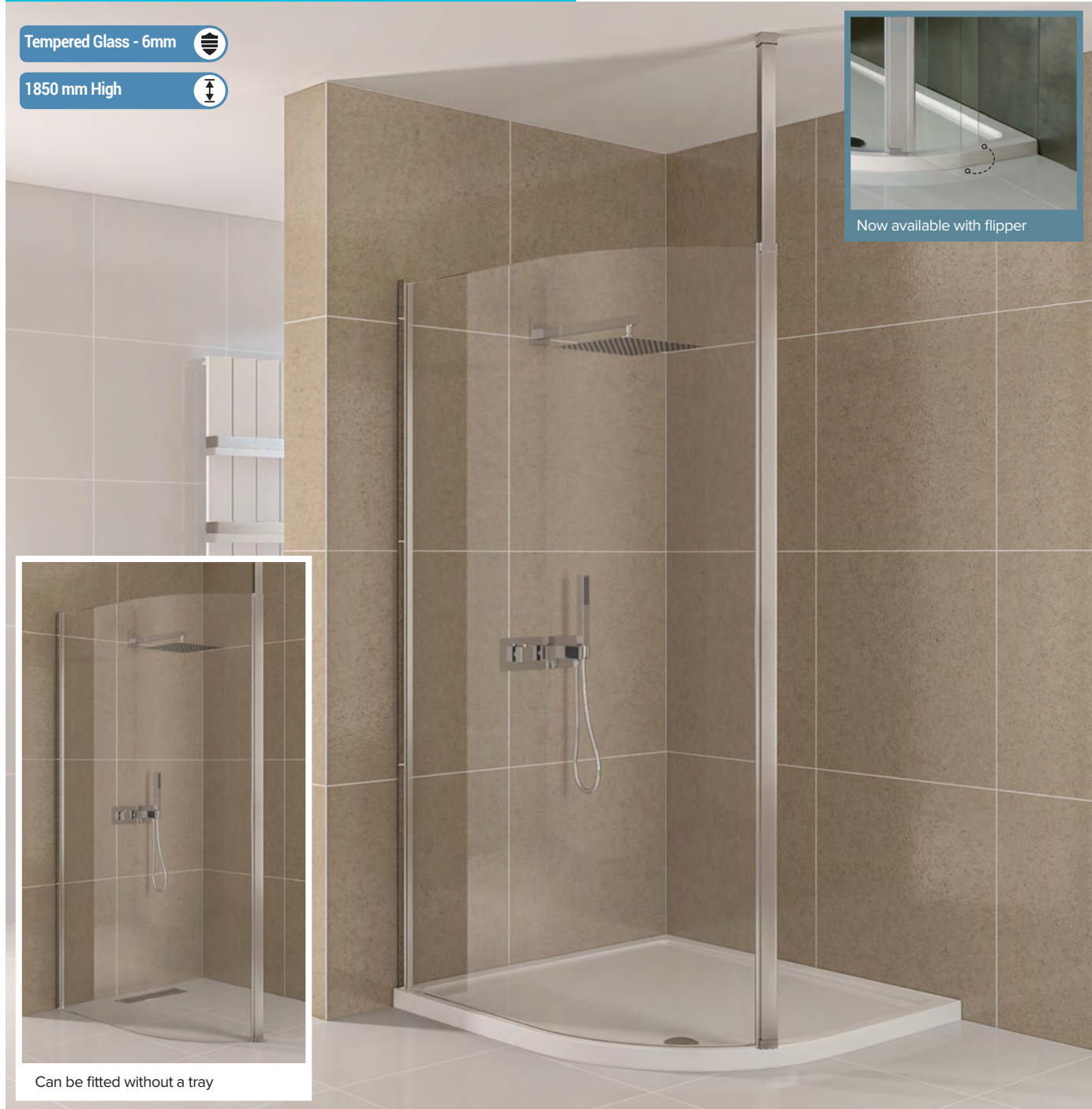

Can be fitted without a tray

PANELS

Valliant Square Pole Walk-In Panels

Size	Adjustment	Code	£ Ex VAT	£ Inc VAT
1000mm Offset panel	990-1000mm	69.0149	431.00	517.20
1100mm Offset panel	1090-1100mm	69.0150	458.00	549.60
1200mm Offset panel	1190-1200mm	69.0151	491.00	589.20
1300mm Offset panel	1290-1300mm	69.0152	512.00	614.40
1400mm Offset panel	1390-1400mm	69.0153	543.00	651.60

All panel sizes are suitable for all tray widths

EXTRAS

Accessories

Description	Code	£ Ex VAT	£ Inc VAT
Flipper for Offset Square Pole 300 x 1850mm	69.0156	178.00	213.60

The Valliant Walk In with ceiling fixing pole. This range does away with the need for intrusive overhead wall bars and fixes straight up to the ceiling. Suitable for ceiling heights of up to 2500mm. 6mm tempered safety glass, height 1850mm. Now available with 300mm flipper.

FEATURES

- 10 Year manufacturer's guarantee*
- 6mm Tempered safety glass
- Easy clean glass
- Polished silver
- *With conditions

Tray Width	Openings
700mm	400mm
760mm	460mm
800mm	500mm
900mm	600mm

NB Approximate, openings will vary depending on tray position/position of enclosure on tray/thickness of tiles. Opening is dependent on tray width not length. Refer to page 479 for available tray sizes.

Valliant Walk-In

VALLIANT ROUND POLE WALK-IN OFFSET

Tempered Glass - 6mm 

1850 mm High 

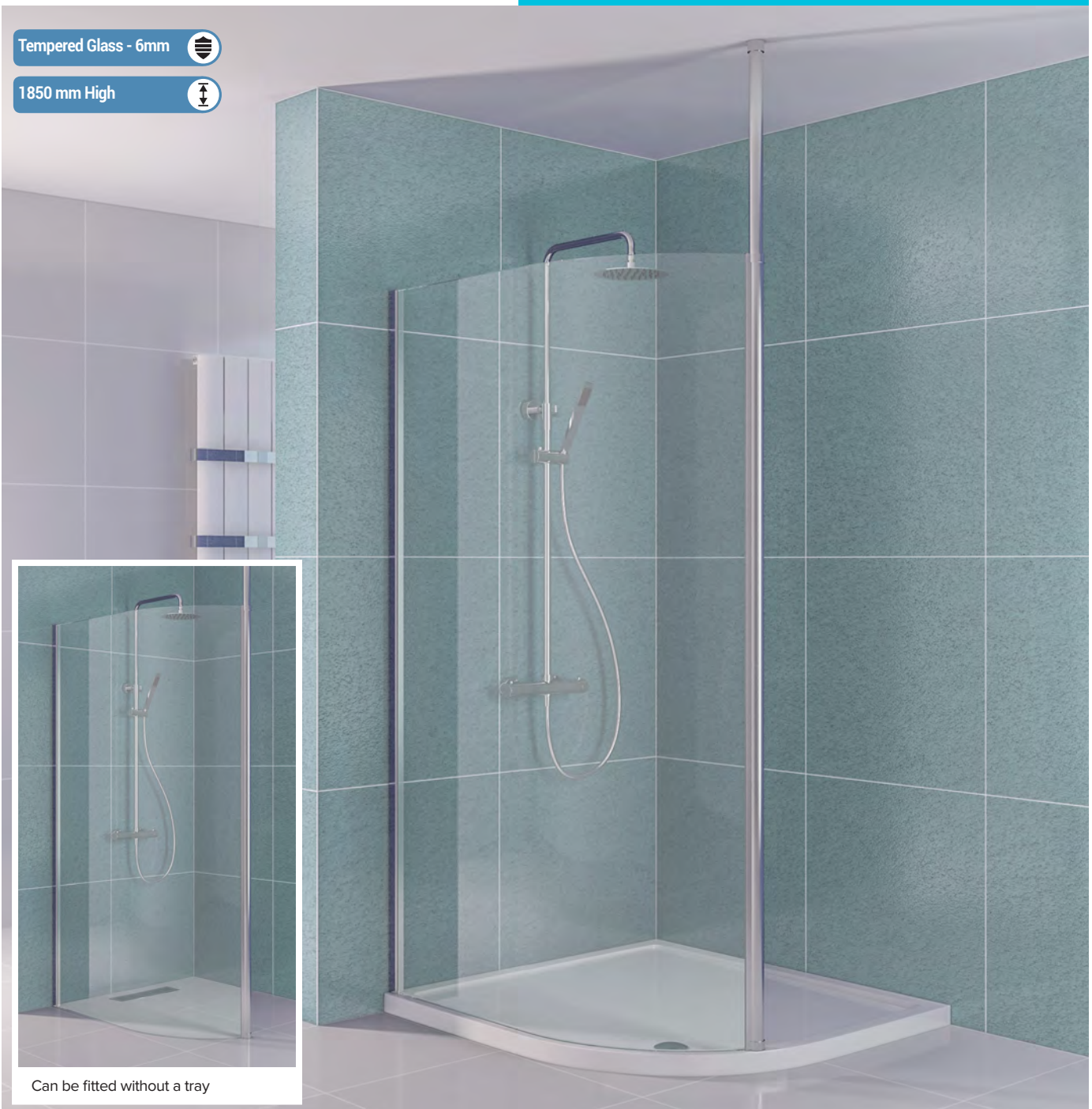

Can be fitted without a tray

PANELS

Valliant Round Pole Walk-In Panels

Size	Adjustment	Code	£ Ex VAT	£ Inc VAT
1000mm Offset panel	990-1000mm	69.0144	433.00	519.60
1100mm Offset panel	1090-1100mm	69.0145	461.00	553.20
1200mm Offset panel	1190-1200mm	69.0146	489.00	586.80
1300mm Offset panel	1290-1300mm	69.0147	516.00	619.20
1400mm Offset panel	1390-1400mm	69.0148	544.00	652.80

All panel sizes are suitable for all tray widths

The Valliant Walk In with ceiling fixing pole. This range does away with the need for intrusive overhead wall bars and fixes straight up to the ceiling. Suitable for ceiling heights of up to 2500mm. 6mm tempered safety glass, height 1850mm.

FEATURES

- 10 Year manufacturer's guarantee*
- 6mm Tempered safety glass
- Easy clean glass
- Polished silver
- *With conditions

Tray Width	Openings
700mm	400mm
760mm	460mm
800mm	500mm
900mm	600mm

NB Approximate, openings will vary depending on tray position/position of enclosure on tray/thickness of tiles. Opening is dependant on tray width not length. Refer to page 477 for available tray sizes.

Biava Wet Floor System

BIAVA WET FLOOR

This product enables you to have a bathroom with a showering area at the same level as the rest of the room giving the benefit of complete level access. It is especially helpful for wheelchair users, the elderly and children. This affordable system incorporates the optimum gradient, drainage and waterproofing all in one package.

The product is able to incorporate benefits such as stylish and elegant designs, flexibility, ease of cleaning, level access, low maintenance with an amazing wow factor and rarely takes more than half a day to install. This proven system comes from a manufacturer with over 300,000 installations, available now through the Eastbrook Biava Brand, with its excellent backup and customer service. It will complement the Eastbrook Volente range of walk-in showering enclosures.



Frequently asked questions about the floor former:

What is a floor former?

A floor former is often mistaken for a shower tray but it is not, in fact it is a preformed floor base with a built in gradient. Its purpose is to offer a simple means of forming the gradient within the construction of either existing or new floors. On completion the floor former will be completely covered with tiles, with only the Stainless Steel Grate visible.

Does it have to be sunk into the floor?

The floor former has been designed to be recessed to a flush finish with the prepared floor. In circumstances where the floor cannot be breached the entire floor can be raised to accommodate the floor former.

How thick is it?

The floor former is 30mm thick.

Is it available in different sizes?

There are 4 different sizes:
1200mm x 900mm
1400mm x 933mm
1600mm x 1067mm
1000mm x 1000mm

Does it need to be fitted level?

It is extremely important that the floor former is fitted level. This is easily checked by placing a spirit level on the perimeter of both sides of the former. Because the gradient is built into the floor former it will only function properly if it is level around its perimeter.

How is the floor drain fitted?

The gully flange fits into the rebate making the top of the gully flange a flush fit with the surface of the floor former.

Is the gully cleanable from the top?

Yes, the gully is accessible from above meaning it can be cleaned without removing the entire drain. This is achieved by the removal of the grating or covers, followed by the dip tube, allowing easy access to the sump of the trap for cleaning.

What about different thicknesses of tiles?

To compensate for different thicknesses of tile the gully has a height adjustable ring which can take a tile thickness of between 6mm-16mm. Also included is a 10mm extension ring to increase the height up to 26mm if required.

What if there is a joist in the way of the gully?

The former has been designed with the waste off centre so that if a joist is in the way of the gully the floor former can be rotated either 90 or 180 degrees, which in most cases will reposition the gully away from the joist. A joist must never be notched or cut to allow installation of the trap.

Can it be fitted in timber floors?

Yes, the floor former is designed to be installed into timber floors. Please refer to the full installation instructions.

Can it be fitted in screeded or concrete floors?

Yes, the floor former can be installed into screeded or concrete floors. Please refer to the separate installation instructions available on request. Special care should be taken in this instance to avoid any obstructions such as cables or pipe work installed under the floor.

Can it be used with underfloor heating?

Yes, it is suitable for all types of underfloor heating.



Biava Wet Floor System

THE EASTBROOK BIAVA WET FLOOR SYSTEM CONSISTS OF:

The Biava Floor Former

There are several sizes of lightweight easy-to-install floor formers with 100% rigidity and a consistent 1:40 gradient. These formers feature a unique four way floor design giving the benefits of clear linear finish and very high flow rate of water to the drainage waste. They are also designed to fit on both timber joisted floors and concrete floors

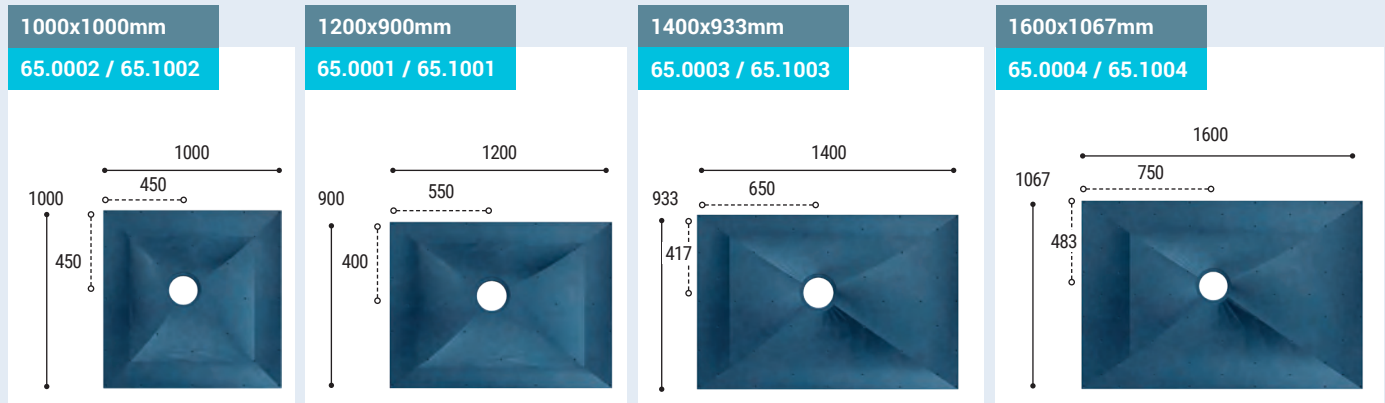

FLOOR FORMERS WITH STANDARD WASTE*

Accessories			
Description	Code	£ Ex VAT	£ Inc VAT
Biava floor former 1200mm x 900mm inc waste	65.0001	482.00	578.40
Biava floor former 1000mm x 1000mm inc waste	65.0002	509.00	610.80
Biava floor former 1400mm x 933mm inc waste	65.0003	557.00	668.40
Biava floor former 1600mm x 1067mm inc waste	65.0004	603.00	723.60

*Floor formers cannot be cut down

FLOOR FORMERS WITH VINYL WASTE*

Accessories			
Description	Code	£ Ex VAT	£ Inc VAT
Biava floor former 1200mm x 900mm inc vinyl waste	65.1001	579.00	694.80
Biava floor former 1000mm x 1000mm inc vinyl waste	65.1002	605.00	726.00
Biava floor former 1400mm x 933mm inc vinyl waste	65.1003	654.00	784.80
Biava floor former 1600mm x 1067mm inc vinyl waste	65.1004	699.00	838.80

*Floor formers cannot be cut down

DRAINAGE WASTE

The shower waste drainage system is fully adjustable and flexible for those awkward joist situations that add so much installation time with other systems.

The waste is adjustable to take tiles from 6 - 26mm. There is also an alternative solution for Vinyl floors.

Waste efficiency decreases when shower head is positioned directly above waste.



BIAVA 5M² MEMBRANE/TANKING KIT

The waterproof tanking kit is quick and easy to install and acts as a key for the tile adhesive as well as being the water proof barrier. Can be bought and used separately to waterproof any bathroom without the need to use a floor former. With some quick set adhesives, tiling can begin almost immediately.

FEATURES

- Quick & easy to install
- 5 metre kit includes joint tape, 4 internal corners and 1 external corner
- 10 year warranty

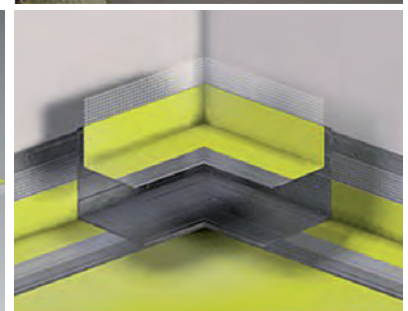
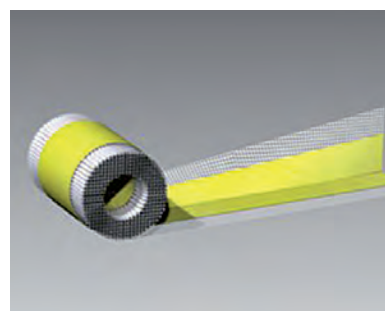

MEMBRANE / TANKING KIT

Accessories			
Description	Code	£ Ex VAT	£ Inc VAT
Biava 5m2 Membrane kit	65.0005	241.00	289.20

NB Drainage waste is included with the Biava floor former.

Volente Trays

VOLENTE SQUARE SHOWER TRAYS



Panels/plinths can only be fitted as illustrated

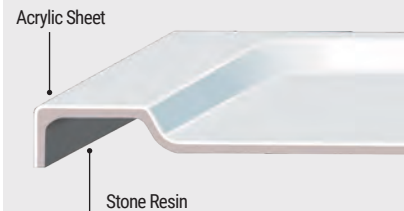
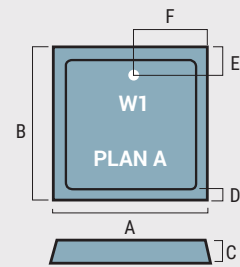

TRAYS

Square Volente Tray

Size	Plan	Waste Position	Waste Size	A	B	C	D	E	F	Code	£ Ex VAT	£ Inc VAT
700 x 700	A	W1	90	700	700	40	65	190	350	158.651	117.00	140.40
760 x 760	A	W1	90	760	760	40	65	190	380	158.050	130.00	156.00
800 x 800	A	W1	90	800	800	40	65	190	400	158.051	140.00	168.00
900 x 900	A	W1	90	900	900	40	65	190	450	158.052	156.00	187.20
1000 x 1000	A	W1	90	1000	1000	40	65	190	500	158.053	191.00	229.20
1100 x 1100	A	W1	90	1100	1100	40	65	190	550	158.691	213.00	255.60
1200 x 1200	A	W1	90	1200	1200	40	65	190	600	158.692	228.00	273.60

Price does not include shower waste

EXTRAS

Legs, Panel Packs & Seal Strip

Description	Code	£ Ex VAT	£ Inc VAT
Volente legs & panel quad trays up to 1200 x 900*	158.081	59.00	70.80
Volente legs & panel for quad trays over 1200	158.085	71.00	85.20
2.8m Flexi Versatile Sealstrip	30.5012	13.00	15.60
Flexible waste pipe	30.400B	11.00	13.20

Panel height 95mm, adjustable legs 85-105mm. *Does not include flexible waste pipe (30.400B)

Chrome Shower Waste

Description	Code	£ Ex VAT	£ Inc VAT
Mega flow shower waste	12.040	14.00	16.80
Volente Luxury Shower Waste Chrome	41.5000	17.00	20.40

Waste efficiency decreases when shower head is positioned directly above waste.



Runners release for ease of cleaning

A versatile range of trays that combines the durability and warmth of an acrylic top surface with the rigidity and solid feel of stone resin. Can be installed using the appropriate leg and panel pack for even greater ease of fitting.

FEATURES

- 40% lighter than a high wall stone resin tray
- Reinforced high strength resin marble material
- Made with WRAS approved resins

Volente Trays

VOLENTE QUADRANT SHOWER TRAYS



Shown below with legs and panel pack, seal strip, flexible waste pipe and waste, which are all sold separately.

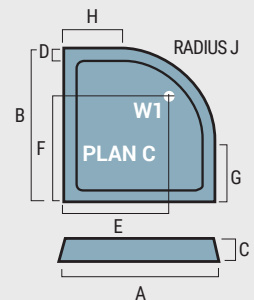
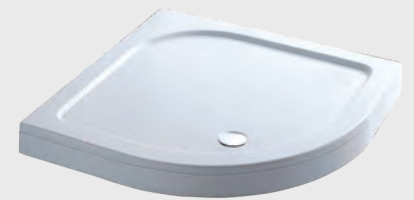
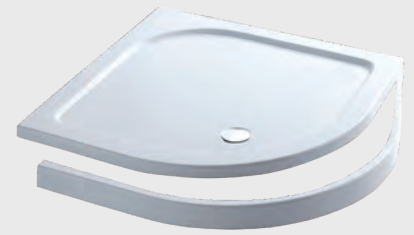

Flexible seal strip sold separately

Waste sold separately

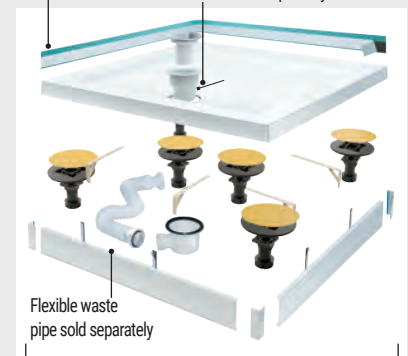

Flexible waste pipe sold separately

Legs and panel kit sold separately

TRAYS

Quadrant Volente Tray

Size	Plan	Waste Position	Waste Size	A	B	C	D	E	F	G	H	J	Code	£ Ex VAT	£ Inc VAT
800 x 800	C	W1	90	800	800	40	65	500	500	250	250	550	158.062	136.00	163.20
900 x 900	C	W1	90	900	900	40	65	600	600	350	350	550	158.063	159.00	190.80
1000 x 1000	C	W1	90	1000	1000	40	65	700	700	450	450	550	158.064	189.00	226.80

Price does not include shower waste

EXTRAS

Legs, Panel Packs & Seal Strip

Description	Code	£ Ex VAT	£ Inc VAT
Volente legs & panel quad trays up to 1200 x 900	158.081	59.00	70.80
Volente legs & panel for quad trays over 1200	158.085	71.00	85.20
2.8m Flexi Versatile Sealstrip	30.5012	13.00	15.60
Flexible waste pipe	30.400B	11.00	13.20

Panel height 95mm, adjustable legs 85-105mm. *Does not include flexible waste pipe (30.400B)

Chrome Shower Waste

Description	Code	£ Ex VAT	£ Inc VAT
Mega flow shower waste	12.040	14.00	16.80
Volente Luxury Shower Waste Chrome	41.5000	17.00	20.40

Waste efficiency decreases when shower head is positioned directly above waste.

FEATURES

- 40% Lighter than a high wall stone resin tray
- Reinforced high strength resin marble material
- Made with WRAS approved resins

Volente Trays

VOLENTE ANTI SLIP RECTANGULAR SHOWER TRAYS



Standard Volente Tray shown above. Prices right >>
Same shape as Volente Anti Slip Trays below.

TRAYS

Volente Anti Slip ABS Stone Resin Trays

Size	Plan	Waste Position	Waste Size	A	B	C	D	E	F	Code	£ Ex VAT	£ Inc VAT
1200 x 800	B	W1	90	1200	800	40	65	190	600	158.718	239.00	286.80
1200 x 900	B	W1	90	1200	900	40	65	190	600	158.719	244.00	292.80
1300 x 800	B	W1	90	1300	800	40	65	190	600	158.720	252.00	302.40
1400 x 800	B	W1	90	1400	800	40	65	190	700	158.721	279.00	334.80
1400 x 900	B	W1	90	1400	900	40	65	190	700	158.722	304.00	364.80
1500 x 800	B	W1	90	1500	800	40	65	190	750	158.723	328.00	393.60
1600 x 800	B	W1	90	1600	800	40	65	190	800	158.724	321.00	385.20
1700 x 700	B	W2	90	1700	700	40	65	350	190	158.726	321.00	385.20
1700 x 800	B	W1	90	1700	800	40	65	190	850	158.725	335.00	402.00
1800 x 800	B	W1	90	1800	800	40	65	190	900	158.727	351.00	421.20
1800 x 900	B	W1	90	1800	900	40	65	190	900	158.728	360.00	432.00

FEATURES

- 40% Lighter than a high wall stone resin tray
- Reinforced high strength resin marble material
- Made with WRAS approved resins
- Anti slip base

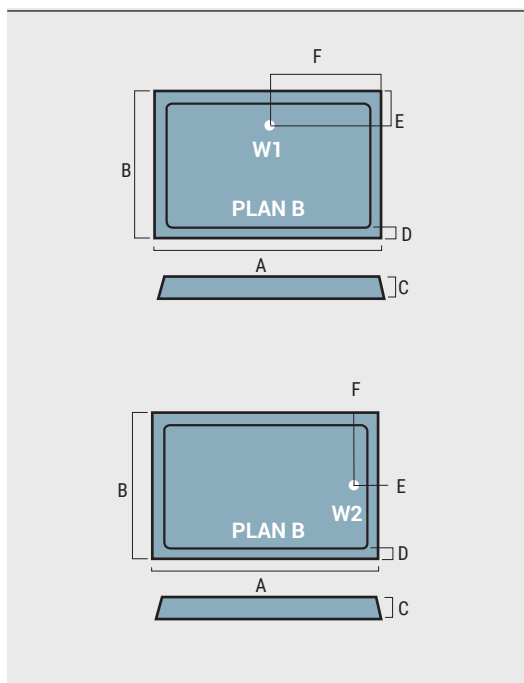

Anti Slip Base



*Subject to cleaning conditions

EXTRAS

Legs, Panel Packs & Seal Strip

Description	Code	£ Ex VAT	£ Inc VAT
Volente legs & panels for up to 1200x1200 rect trays*	158.080	59.00	70.80
Volente legs & panels for up to 2000x900 rect trays	158.082	86.00	103.20
1200 Tray Panel only for three sided installation	158.682	24.00	28.80
2.8m Flexi Versatile Sealstrip	30.5012	13.00	15.60
Flexible waste pipe	30.400B	11.00	13.20

Panel height 95mm, adjustable legs 85-105mm.

*Does not include flexible waste pipe (30.400B)

EXTRAS

Chrome Shower Waste

Description	Code	£ Ex VAT	£ Inc VAT
Mega flow shower waste	12.040	14.00	16.80
Volente Luxury Shower Waste Chrome	41.5000	17.00	20.40

Waste efficiency decreases when shower head is positioned directly above waste.

Volente Trays

VOLENTE OFFSET QUAD SHOWER TRAYS



Vanguard Trays

VANGUARD 25 SHOWER TRAYS

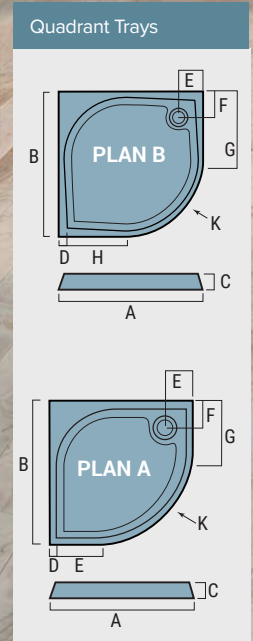

A versatile range of trays that combines the durability and warmth of an acrylic top surface with the rigidity and solid feel of stone resin.

FEATURES

- Soft grip textured base
- Made of cast resin - 75% marble stone
- Repairable if chipped
- Easy clean surface

TRAYS

Quadrant Vanguard Tray														Code	£ Ex VAT	£ Inc VAT
Size	Plan	Waste	A	B	C	D	E	F	G	H	J	K				
800 x 800	A	STD	802	802	30	40	160	150	252	252	550	-	51.055	160.00	192.00	
900 x 900	B	STD	902	902	30	40	-	172	352	352	550	60	51.057	197.00	236.40	
1000 x 1000	B	STD	1002	1002	30	40	-	180	452	452	550	60	51.060	216.00	259.20	

Quadrant Trays



Safety

The Vanguard's outer white nanocoat surface is created with a soft grip texture; purposely designed for safety whilst showering.

Quality

With just one touch you will feel the nature inherent within the Vanguard Tray ranges Mineral Composite. This material combination attains a whole new level of durability within the bathroom environment:

- 75% Marble Stone
- Compressed Resin Bond
- Nanocoat External Layer

By having the external white nanocoat surface, the Vanguard range has an insusceptibility to bacterial growth and absorption of water. This ensures a long lasting quality and ease of care

Mineral Composite Profile

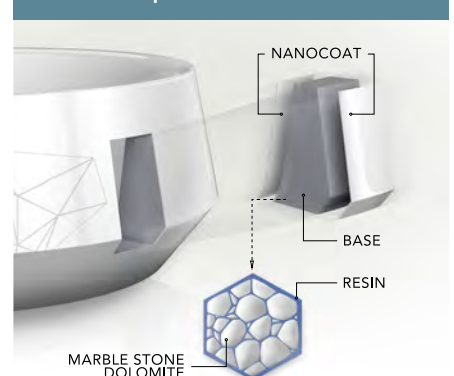

Vanguard Trays

Design

The Mineral Composite enables an extensive range of shapes to be created and frees up the imagination of designers. With a 0-to-3mm tolerance and a minimum radius of 2mm, the Vanguard is precise by its very nature. Effortlessly elegant.

30MM HEIGHT SLIMLINE DESIGN



SOFT GRIP TEXTURED BASE

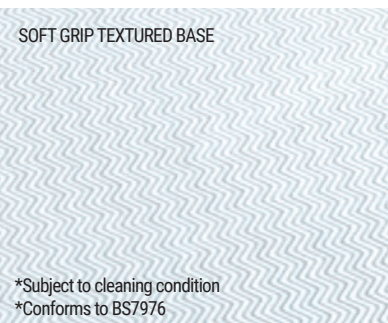

*Subject to cleaning condition
*Conforms to BS7976

TRAYS

Square Vanguard 25 Trays

Size	Plan	Waste Position	Waste Size	A	B	C	D	E	F	Code	£ Ex VAT	£ Inc VAT
700 x 700	C	-	STD	702	702	30	40	150	150	51.052	130.00	156.00
800 x 800	C	-	STD	802	802	30	40	150	150	51.054	160.00	192.00
900 x 900	C	-	STD	900	900	30	40	180	180	51.056	197.00	236.40
1000 x 1000	C	-	STD	1002	994	30	40	150	150	51.061	216.00	259.20

Rectangular Vanguard 25 Trays

Size	Plan	Waste Position	Waste Size	A	B	C	D	E	F	Code	£ Ex VAT	£ Inc VAT
800 x 760	D	W1	STD	802	762	30	40	151	151	51.071	162.00	194.40
900 x 700	E	W2	STD	902	702	30	40	451	351	51.053	154.00	184.80
900 x 800	D	W1	STD	902	802	30	40	151	151	51.072	188.00	225.60
1000 x 700	D	W1	STD	1002	702	30	40	151	151	51.058	175.00	210.00
1000 x 800	D	W1	STD	1002	802	30	40	151	151	51.059	191.00	229.20
1000 x 900	D	W1	STD	1002	902	30	40	151	151	51.073	216.00	259.20
1100 x 800	D	W1	STD	1102	802	30	40	151	151	51.074	214.00	256.80
1200 x 700	D	W1	STD	1202	702	30	40	151	151	51.062	203.00	243.60
1200 x 760	D	W1	STD	1202	762	30	40	151	151	51.075	216.00	259.20
1200 x 800	D	W1	STD	1202	802	30	40	151	151	51.063	215.00	258.00
1200 x 900	E	W2	STD	1202	902	30	40	601	451	51.064	228.00	273.60
1300 x 800	E	W2	STD	1302	802	30	40	651	401	51.076	244.00	292.80
1300 x 900	E	W2	STD	1302	902	30	40	651	451	51.077	265.00	318.00
1400 x 700	E	W2	STD	1402	702	30	40	701	351	51.078	234.00	280.80
1400 x 800	E	W2	STD	1402	802	30	40	701	401	51.065	239.00	286.80
1400 x 900	E	W2	STD	1402	902	30	40	701	451	51.066	284.00	340.80
1500 x 800	E	W2	STD	1502	802	30	40	751	401	51.079	273.00	327.60
1500 x 900	E	W2	STD	1502	902	30	40	751	451	51.080	304.00	364.80
1600 x 700	E	W2	STD	1602	702	30	40	801	351	51.081	247.00	296.40
1600 x 800	E	W2	STD	1602	802	30	40	801	401	51.067	288.00	345.60
1600 x 900	E	W2	STD	1602	902	30	40	801	451	51.068	335.00	402.00
1700 x 700	E	W2	STD	1702	702	30	40	851	351	51.082	310.00	372.00
1700 x 750	E	W2	STD	1702	752	30	40	851	376	51.083	323.00	387.60
1700 x 800	E	W2	STD	1702	802	30	40	851	401	51.069	317.00	380.40
1700 x 900	E	W2	STD	1702	902	30	40	851	451	51.084	383.00	459.60
1800 x 800	E	W2	STD	1802	802	30	40	901	401	51.070	370.00	444.00
1800 x 900	E	W2	STD	1802	902	30	40	901	451	51.085	426.00	511.20

Price does not include shower waste. If you do require a different tray with a leg & panel kit, please see Volente trays pages 476-479.

EXTRAS

Chrome Shower Waste

Description	Code	£ Ex VAT	£ Inc VAT
Mega flow shower waste	12.040	14.00	16.80
Volente Luxury Shower Waste Chrome	41.5000	17.00	20.40

Waste efficiency decreases when shower head is positioned directly above waste. Please note that the Rectangular Vanguard 25 Trays are not compatible with leg & panel kits.

VANGUARD 25 SHOWER TRAYS

Square Trays

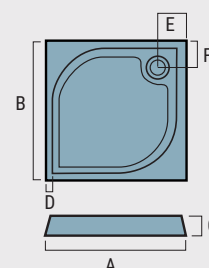

Rectangular Trays

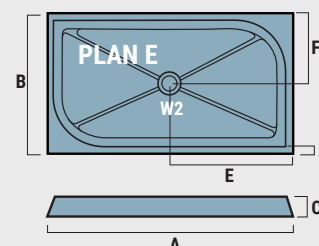
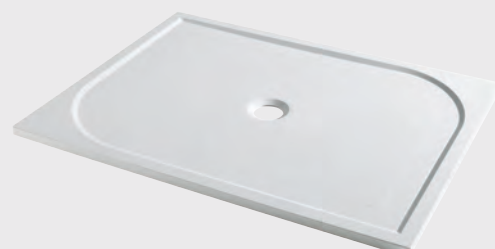
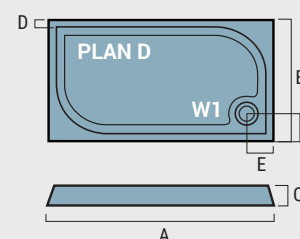



Panelling

Hydropanel shower panelling with decorative laminate on the front and a balancer laminate on the reverse. PVC panels, ideal for walls and ceilings in bathrooms, showers and kitchen.

Contents

Hydropanel	484 - 485
Mirror gloss hydropanel	486
Fitting Instructions	487 - 488
Standard PVC hydropanel	489
PVC Widepanels	490 - 491



Hydropanel

MDF Cores

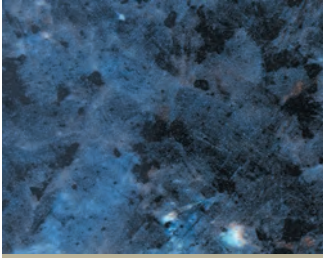

Pacific Blue Granite Gloss



New Marble White Gloss



Slate



White Speckle



White Gloss



Travertine Gloss

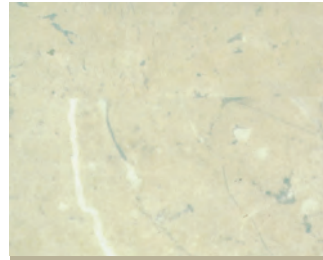

Marble Cream Gloss

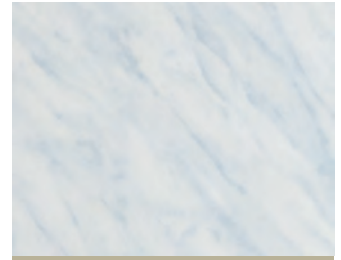

New Marble Blue Gloss



Black Speckle



Black Leaf



Pebbles



Mother Of Pearl Gloss

This is our original shower panelling product consisting of a plywood core (T & G MDF core) with the decorative laminate on the front and a balancer laminate on the back. This is a very durable 10mm thick product with a very hard wearing face. It also has a degree of structural rigidity which can be an advantage in certain installations.

It is supplied in three formats:

1200 x 2430mm
Square edged

900 x 2430mm
Square edged

600 x 2430mm with tongue and groove edges

This product can be bonded straight to the wall so long as the wall is straight and true. The surface of the wall will also need to be evaluated as to whether it will support the bonded boards suitably. Alternatively the boards can be bonded to a timber framework which can be used to straighten up walls that are not true. As with all Hydropanel products our own sealants and adhesives should be used.



Granite Gloss

Mirror Gloss Hydropanel



Mirror Gloss Black

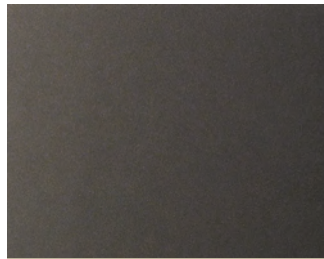

Mirror Gloss Anthracite

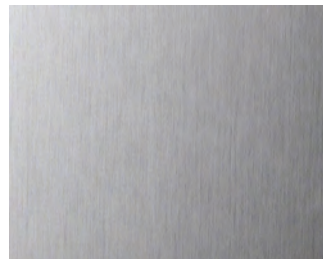

Mirror Gloss Brushed Aluminium



Mother Of Pearl Gloss

An Eastbrook favourite is the fantastic hydropanel with a mirror gloss finish. Available in 1200mm lengths in four striking finishes, it is hard wearing and colour fast. This product combines all the proven qualities of the standard hydropanel with this exciting new finish.

PVC Widepanel

Pages 490-491

Ideal for walls and ceilings in bathrooms, showers and kitchens



Marble Cream

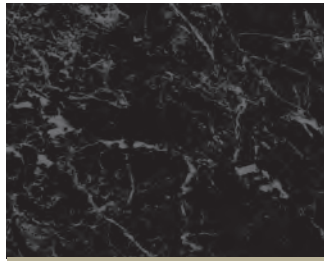

Black Marble



Travertine Gloss



Black Sparkle

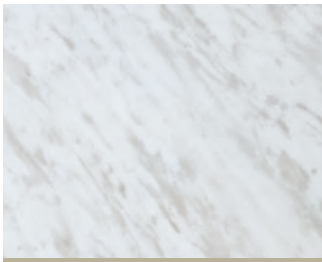

Carrara Marble



Marble Blue

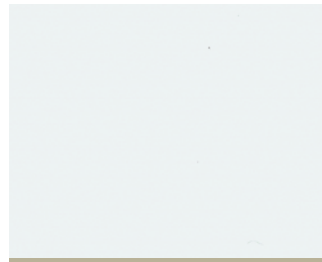

White

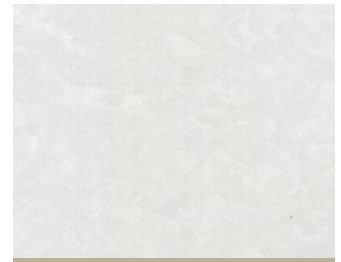

Pearl White



White Sparkle



Mother Of Pearl

This is a cellular PVC product 10.5mm thick and is supplied in a 1000 x 2400mm board. This is a heavier and more rigid product than the PVC Hydropanel and would be suitable for more demanding applications.

This product can be bonded straight to the wall so long as the wall is straight and true. The surface of the wall will also need to be evaluated as to whether it will support the bonded boards suitably.

Alternatively the boards can be bonded to a timber framework which can be used to straighten up walls that are not true. As with all Hydropanel products our own sealants and adhesives should be used.



CONCRETE BEIGE MATT



Concrete Beige Matt

Standard PVC ceiling and wall panelling

Pages 489

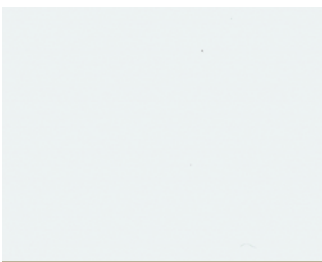

White

PVC Hydropanel

This is also a cellular PVC product, 5mm thick and supplied in packs of four planks which are 250mm wide. Available in lengths of 2400mm and 3000mm long planks which make it ideal for use on ceilings.

This is a lightweight product which is very fast and easy to install.

This product can be bonded straight to the wall so long as the wall is straight and true. The surface of the wall will also need to be evaluated as to whether it will support the bonded boards suitably. Alternatively the

boards can be bonded to a timber frame work which can be used to straighten up walls that are not true. As with all Hydropanel products our own sealants and adhesives should be used.

Hydropanel

HYDROPANEL SHOWER PANELLING

Colour samples subject to the limitations of the printing process



Marble mint green gloss



White Gloss

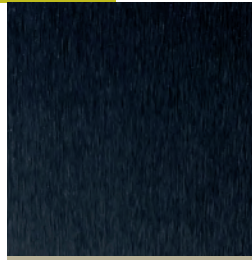

Brushed Black



Granite Gloss



Black Leaf



White Speckle



Black Speckle

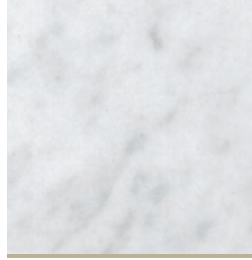

New Marble White Gloss

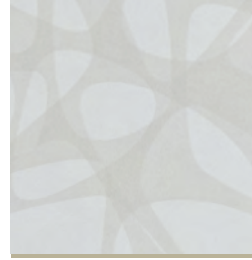

Pebbles

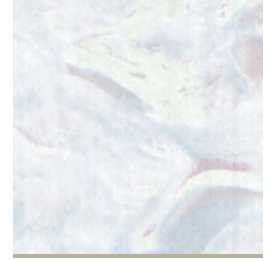

Mother of Pearl Gloss



Travertine Gloss

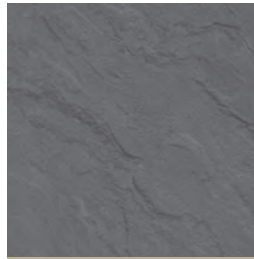

Slate Matt

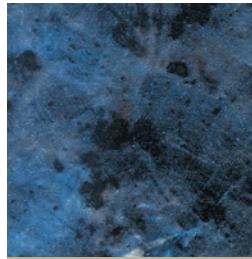

Pacific blue granite

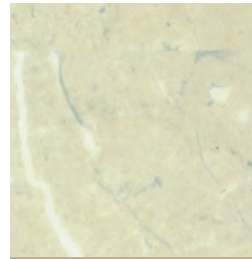

Marble cream gloss

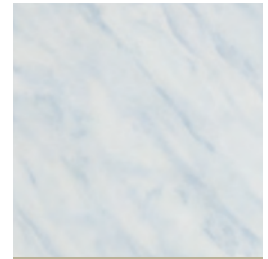

New marble blue gloss

Straight edge stock panels. All 900mm panels are 2420mm high, all 1200mm panels are 2420mm high, 10mm thick.

Straight Edge Stock Panels

Colour	900mm	£ Ex VAT	£ Inc VAT	1200mm	£ Ex VAT	£ Inc VAT
Marble mint green gloss	3.101	162.00	194.40	3.201	184.00	220.80
New marble blue gloss	3.122†	162.00	194.40	3.222†	184.00	220.80
New marble white gloss	3.121	158.00	189.60	3.221	179.00	214.80
Pacific blue granite gloss	3.108	165.00	198.00	3.208	189.00	226.80
White gloss	3.112	158.00	189.60	3.212	179.00	214.80
New Granite gloss	3.129	162.00	194.40	3.229	193.00	231.60
Mother of pearl gloss	3.116	168.00	201.60	3.216	193.00	231.60
Travertine gloss	3.126	168.00	201.60	3.226	193.00	231.60
Slate matt	3.119	168.00	201.60	3.219	193.00	231.60
Black leaf	-	-	-	3.223	208.00	249.60
Pebbles	-	-	-	3.224	194.00	232.80
Brushed black	-	-	-	3.225	204.00	244.80
White speckle	-	-	-	3.227	209.00	250.80
Black speckle	-	-	-	3.228	209.00	250.80

†While stocks last



SWATCHES AVAILABLE



Join 'H'



End 'U'



External



Internal



L



Scotia

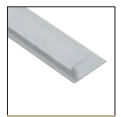

Base Seal



Silver



Anthracite



Bright Silver



Gold



White

Extrusions. All 2430-2440mm lengths.

Straight Edge Stock Panels

Description	Bright Silver	£ Ex VAT	£ Inc VAT	Satin Silver	£ Ex VAT	£ Inc VAT	White	£ Ex VAT	£ Inc VAT	Gold	£ Ex VAT	£ Inc VAT	Anthracite	£ Ex VAT	£ Inc VAT
Hydropanel Internal	32.311	29.00	34.80	32.001	28.00	33.60	32.101	30.00	36.00	32.201†	45.00	54.00	32.301	47.00	56.40
Hydropanel External	32.312	33.00	39.60	32.002	30.00	36.00	32.102	33.00	39.60	32.202†	45.00	54.00	32.302	51.00	61.20
End 'U'	32.313	26.00	31.20	32.003	18.00	21.60	32.103	21.00	25.20	-	-	-	32.303	32.00	38.40
Join 'H'	32.314	27.00	32.40	32.004	24.00	28.80	32.104	28.00	33.60	32.204†	34.00	40.80	32.304	38.00	45.60
'L' shape	32.319	20.00	24.00	32.009	16.00	19.20	32.109	17.00	20.40	-	-	-	-	-	-
Scotia	32.320	25.00	30.00	32.010	20.00	24.00	32.110	21.00	25.20	-	-	-	-	-	-
Base seal	32.318	24.00	28.80	32.008	19.00	22.80	32.108	19.00	22.80	32.208†	26.00	31.20	32.308	19.00	22.80

Note: Gold is antique, silver is anodised and white is powder coated. †While stocks last

Hydropanel

HYDROPANEL SHOWER PANELLING



Pebbles hydropanels shown

Hydropanel conforms to class 3 standard fire grade. Class 1 can be obtained with a lead time of approximately one month and a 20% surcharge.

Pictures not to scale.

As with all decorative products, differences in shading can occur between batches.

Please ensure you order enough for the job in hand and also ensure that shades and colours are checked and approved on site before installation commences.

Colour samples available subject to the limitations of the printing process.

Accessories			
Description	Code	£ Ex VAT	£ Inc VAT
Hydropanel Adhesive 310ml*	32.005	11.00	13.20
Hydropanel Sealant 310ml*	32.006	11.00	13.20
Hydropanel Cleaner 500ml	32.007	10.00	12.00

*Normal requirement 1 tube per

FEATURES

- Lightweight core material
- Waterproof surface
- Chemical resistant
- Easy clean surface
- Resistant to distortion
- Fade free

600mm Tongue and groove panels			
Colour	Code	£ Ex VAT	£ Inc VAT
Marble Green Gloss	3.601	107.00	128.40
New Marble White Gloss	3.621	110.00	132.00
Pacific Blue Granite Gloss	3.608	115.00	138.00
White Gloss	3.612	111.00	133.20
New Granite Gloss	3.629	115.00	138.00
Mother of Pearl Gloss	3.616	112.00	134.40
Slate Matt	3.619	118.00	141.60
Travertine Gloss	3.626	115.00	138.00

2430 mm high, 11mm thick. Please note: Panels are 600mm wide, finished face 585mm.

Mirror Gloss Hydropanel

MIRROR GLOSS HYDROPANEL



Mirror Gloss Black

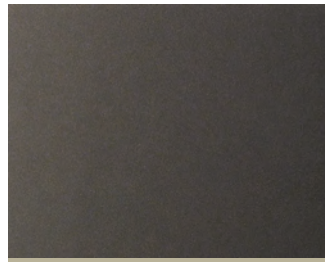

Mirror Gloss Anthracite

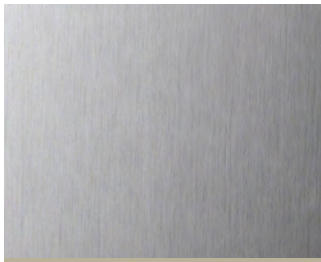

Mirror Gloss Brushed Aluminium



Mirror White Gloss

Use our new, highly durable mirror gloss hydropanel to add an extra dimension to your next bathroom project. All panels are 2420mm long and 11mm thick.

Panels				
Description	Colour	Code	£ Ex VAT	£ Inc VAT
Mirror gloss hydropanel 1200mm	White	3.700	217.00	260.40
Mirror gloss hydropanel 1200mm	Black	3.701	228.00	273.60
Mirror gloss hydropanel 1200mm	Anthracite	3.702	299.00	358.80
Mirror gloss hydropanel 1200mm	Brushed Aluminium	3.703	299.00	358.80

FEATURES

- Mirror gloss surface
- Highly durable surface
- Waterproof surface
- Easy clean
- Fade free

Bright silver extrusions

Description	Bright Silver	£ Ex VAT	£ Inc VAT
Hydropanel Internal	32.311	29.00	34.80
Hydropanel External	32.312	33.00	39.60
End 'U'	32.313	26.00	31.20
Join 'H'	32.314	27.00	32.40
Base seal	32.318	24.00	28.80
'L' shape	32.319	20.00	24.00
Scotia	32.320	25.00	30.00

Colours are subject to the limitations of the printing process, and should only be used as a guide to colour matching.

NB: As with all decorative products differences in shading can occur between batches. Please ensure you order enough to complete the job in hand.

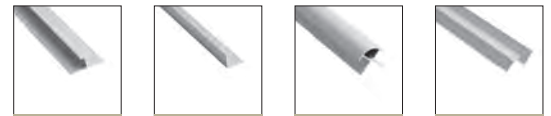

Join 'H' End 'U' External Internal



L Scotia Base Seal

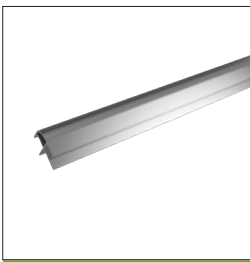

Silver

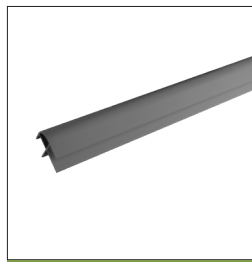

Anthracite

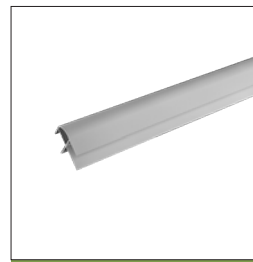

Bright Silver

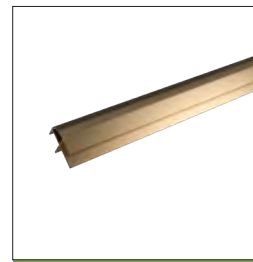

Gold



White

Extrusions. All 2500mm lengths

Description	Silver	£ Ex VAT	£ Inc VAT	White	£ Ex VAT	£ Inc VAT	Gold	£ Ex VAT	£ Inc VAT	Anthracite	£ Ex VAT	£ Inc VAT
Hydropanel Internal	32.001	28.00	33.60	32.101	30.00	36.00	32.201†	45.00	54.00	32.301	47.00	56.40
Hydropanel External	32.002	30.00	36.00	32.102	33.00	39.60	32.202†	45.00	54.00	32.302	51.00	61.20
End 'U'	32.003	18.00	21.60	32.103	21.00	25.20	-	-	-	32.303	32.00	38.40
Join 'H'	32.004	24.00	28.80	32.104	28.00	33.60	32.204†	34.00	40.80	32.304	38.00	45.60
'L' shape	32.009	16.00	19.20	32.109	17.00	20.40	-	-	-	-	-	-
Scotia	32.010	20.00	24.00	32.110	21.00	25.20	-	-	-	-	-	-
Base seal	32.008	19.00	22.80	32.108	19.00	22.80	32.208†	26.00	31.20	32.308	19.00	22.80

Note: Gold is antique, silver is anodised and white is powder coated. †While stocks last

Hydropanel Instructions

Instructions

Tongue & Groove or square cut wall panels

General notes on fixing panels

Panels can be fixed directly to battens or walls using Hydropanel panel adhesive. It is recommended that the panels are fixed to battens to provide air space behind. Fix treated timber battens approximately 45mm x 21mm horizontally with one at the head and one at the base of the panels. Additional horizontal battens should be a maximum distance of 500mm apart. They should be parallel to each other and plumb to give a solid ground for fixing the panels with Hydropanel adhesive. Additional battens should be used behind wash hand basins, towel rails and other heavy items to give a secure fixing.

Panel Preparation

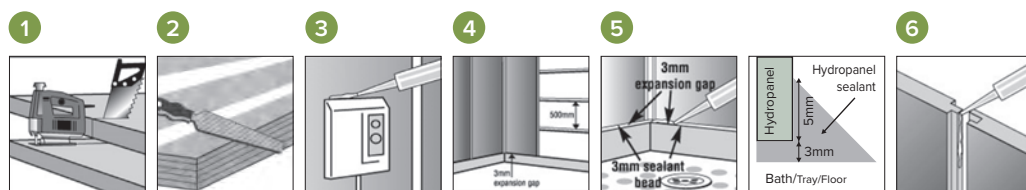

1. Cutting Panels:

Cut panel with pattern facing upwards using a handsaw. If using an electric saw, cut panel with laminate face downwards.

2. Cut Edge Filing:

The panel edge should be filed at a slight angle away from the laminate edge.

3. Pipes and Accessories:

All pipes and accessories require a 3-4mm clearance, allowing them to be sealed with a bead of Hydropanel sealant. If fitting a collar, first seal with Hydropanel sealant.

4. Timber Battens:

(45mm x 21mm) Use battens if walls are uneven, at a maximum distance of 500mm apart. Fix panels to battens using Hydropanel adhesive.

5. Panel Fitting:

Fit panels 3mm above bath, shower tray or floor, with edge downwards. Seal gap with Hydropanel sealant. It is imperative that all edges are sealed and the sealant is taken 5mm up the face of the panel at a 45° angle.

6. Panel & Decor Strip Sealing:

In wet areas such as a bathroom, use Hydropanel sealant inside each profile prior to inserting panel.

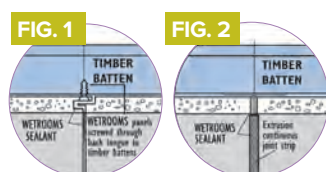

Hydropanel

Tongue & Groove Recommended for continuous panel runs

The vertical edges are tongue and grooved to give the finished panelling a smooth, easily maintained surface. Panels have asymmetrical tongue and grooved vertical edges giving 5mm of joint overlap. A waterproof joint is assured when sealed with Hydropanel sealant.

Installation

1. Where to start:

Panel in both directions around the room, starting at the corner furthest from the door. Fit the last panel above the doorway, placed in position tongue first and swung into position. All panels must be correctly aligned and plumb. Use Hydropanel panel adhesive to fix panels to battens. Seal all panel joints using Hydropanel sealant.

2. Begin Panelling:

Fix a Hydropanel internal profile in position first ensuring that it is plumb. Apply Hydropanel sealant to the recess of the profile. Apply Hydropanel adhesive to the battens. After removing the smaller tongue, or cutting to size insert the first panel. Continue to panel away from the corner in both directions, fixing panels to battens with Hydropanel adhesive, and sealing joints with Hydropanel sealant.

3. Continue Panelling:

Continue panelling around the room fixing each panel to the battens with Hydropanel adhesive, or screws through the back lip of grooved edge. Seal tongue and groove joints using Hydropanel sealant. Where appropriate use internal and external corner profiles, sealing with Hydropanel sealant.

Square cut with aluminium joint extrusions which allow for on site cutting, the edges being covered by aluminium trim extrusions. This will facilitate for faster installation.

4. Fit the shower tray hard against or cut into the wall. First cut the panels and profiles to size. Fix a Hydropanel internal profile in position ensure that it is plumb. Apply Hydropanel sealant into profile and insert panels. Fix panels to battens using Hydropanel panel adhesive.

5. First panel is fitted as for the two panel shower enclosure. Put a second internal corner profile onto the edge of second panel, and apply Hydropanel adhesive to the battens. Insert other edge into profile already attached to the wall, and swing into place forming back of enclosure. Fix profile to wall, insert third panel and glue to wall. Ensure a generous bead of Hydropanel sealant is applied into all the profiles.

6. Finish outer panel edges with U-Trim, applying a bead of Hydropanel sealant into the U-Trim. Seal all gaps around the tray with Hydropanel sealant prior to installing the shower door or side panel.

Use the H continuous run decorative aluminium joining and stacking profile to join panels and install in a similar manner to tongue and groove panelling, applying a generous bead of Hydropanel sealant into the profile.

Aluminium Profiles

Available in silver, white and antique gold†

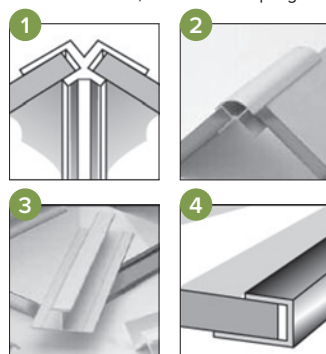

1. Internal corner profile:

2400mm. Used on all internal 90° corners sealing with Hydropanel sealant.

2. External corner profile:

(2500 mm) Used on 90° external corners, sealing with Hydropanel sealant.

3. Joining and stacking profile:

(2500 mm) Used to mount panels side by side, or above each other, sealing with Hydropanel sealant.

4. U-TRIM:

(2500 mm) Finishing touches and cap for square cut edge of panel, sealing with Hydropanel sealant.

Hydropanel Adhesives and Sealants

It is recommended that only Hydropanel's own brand adhesives and sealants are used. Approximately 1 cartridge of Hydropanel adhesive and 1 cartridge of Hydropanel sealant is required for a 800 mm wide panel.

Cleaning and maintenance

The hardwearing surface of the panelling and aluminium profiles can be hygienically cleaned with Hydropanel spray cleaner which is a mild non-abrasive cleaner with anti-bacterial cleanser.

Abrasive cleaners or bleach must not be used.

A large variety of possible applications:

DOMESTIC: Walls of showers, kitchens, wet areas, utility rooms, conservatories, extensions etc.

COMMERCIAL: Hotels (bathrooms, kitchens, wet areas, reception areas, etc). Cafeterias (food preparation areas, kitchens, toilet facilities, etc) offices, shops, hospitals, schools, laboratories, etc.

PVC Panel Instructions

How to Fit the PVC Profiles

- Hygienic, washable and easy to maintain
- Very simple to install
- Can be cut to size very easily
- Save up to 50% of the cost of conventional tiling
- Ideal for bathrooms, showers, kitchens etc
- A wide range of stunning decors
- Excellent insulation and sound proofing
- Recyclable

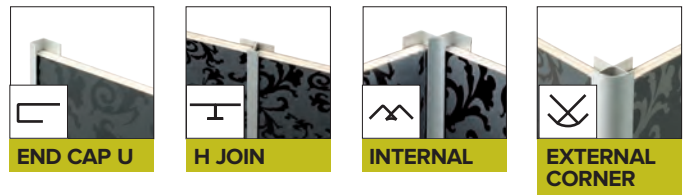

Fix Directly On To Wall

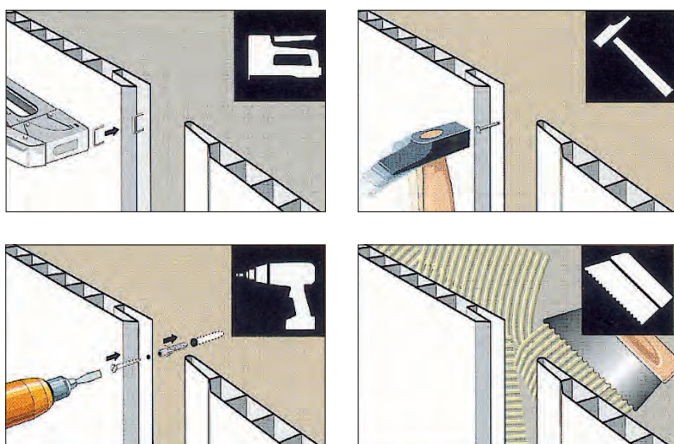

Fix Directly Onto Batten

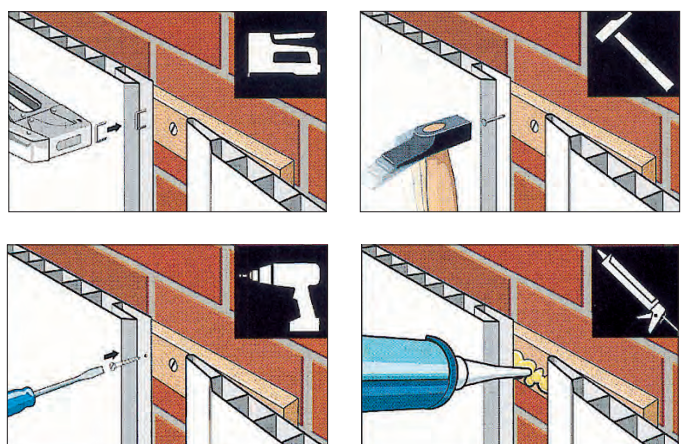

Assembly Instructions

There are two ways to assemble the tongue and groove wall panels. Either glue or fix directly on to the wall if the surface is relatively even and dry. Use 'Wetwall Adhesive' or fix on to a wooden frame. Fixing to timber battens is easy: a staple gun, hammer and nails, screws or 'Wetwall Adhesive' can be used.

To make the wooden frame, strap the wall with wooden battens approx. every 50cm according to the direction of your panel assembly. To install the panels vertically, lath the wall horizontally and vice versa. If the panels are to be placed diagonally, the wall may be lathed either horizontally or vertically.

Start with installing the preferred P.V.C. profiles on the sides (start at edge trim, or inside corner).

Nail, staple, screw or glue the first panel to the wooden battens. Silicone seal all ends, joints and profiles in a wet area such as a shower or around a bath with Wetwall sealant.

Insert the next panel (side with tongue) into the groove of the previous panel. Nail, staple, screw or glue the panel along the tongue on the opposite side. Proceed in a similar manner for the fixing of all panels.

SEALING: To seal the joint between two panels we recommend using 'Wetwall Silicone Sealant' when sealing in wet areas, in the shower or around the bath.

CUTTING: We recommend when using a precision handsaw, cutting the panel with the decorative side upwards. When using an electric saw cut panel with decorative side downwards.

Benefits Of Using Wetroom Adhesives, Sealants And Cleaners

Wetroom Sealant is of the highest quality silicone. It is a fast curing, low modulus, neutral, fungicidal silicone sealant, developed for use with Wetroom panelling, and for general sanitary use.

- Wetroom Sealant forms a strong secure bond even between two non-porous surfaces.
- Wetroom Sealant has a high degree of elasticity, which ensures that the bond remains firm during the natural expansion and contraction of the panelling.
- Wetroom Sealant is designed for high pressure and pumped shower systems.

It is required the only Wetroom's own brand of adhesive sealant and cleaner are used.

Adhesive cleaners and bleaches must not be used on Wetroom panelling.



Accessories			
Description	Code	£ Ex VAT	£ Inc VAT
Hydropanel Adhesive 310ml*	32.005	11.00	13.20
Hydropanel Sealant 310ml*	32.006	11.00	13.20
Hydropanel Cleaner 500ml*	32.007	10.00	12.00

*Normal requirement one tube per panel. For a packet of four panels, approximately one cartridge of Wetroom adhesive and one cartridge of Wetroom sealant is required.

**Hydropanel cleaner is required on surface and panels.

Standard PVC Panelling

STANDARD PVC CEILING AND WALL PANELLING



Ideal for kitchens, bathrooms and showers

- New 3m long panel in white
- 250mm wide tongue and groove panels
- Wetwall panels for all showers
- Suitable for wet and dry areas
- Suitable for both walls and ceilings
- Easy installation, no wet trades required
- Full range of accessories
- Hygienic wipe clean surface

- Standard PVC Hydropanels and profiles are 2400mm long (Profiles can vary by up to 2%)
- Non-porous and mould free
- H-join decor strips available in silver and gold
- Virtually maintenance free
- No tiling or grouting to discolour or leak
- Excellent insulation and sound proofing
- Class 1 fire rating
- Approx 5mm thickness

White is subject to the limitations of the printing process, and should only be used as a guide to colour matching.

NB: As with all decorative products differences in shading can occur between batches. Please ensure you order enough to complete the job in hand.

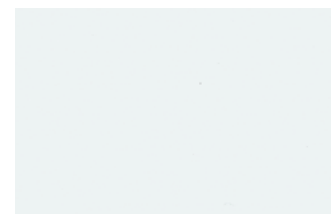

White

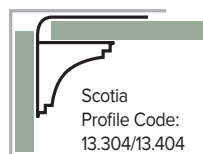
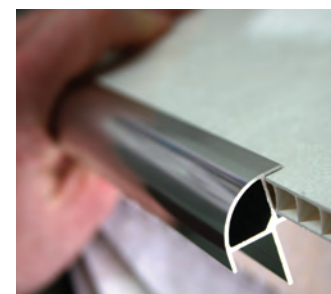

Hardwearing PVC surface suitable for all areas domestic and commercial.

Profiles

Description	White	Black	Silver	Gold	£ Ex VAT	£ Inc VAT
PVC Hydropanel internal corner	13.301	13.401	13.001	13.201†	11.00	13.20
PVC Hydropanel external corner	13.302	13.402	13.002	13.202†	12.00	14.40
PVC End cap U	13.303	13.403	13.003	-	9.00	10.80
PVC Join H decor strip	13.306	13.406	13.006	13.206†	9.00	10.80
PVC Scotia	13.304	13.404	-	-	9.00	10.80

FEATURES

- Lightweight core material
- Water resistant
- Easy clean surface

†While stocks last

Panels

Description	Colour	Code	£ Ex VAT	£ Inc VAT
PVC Hydropanel pack of 4 (2.4m ²)	White Gloss	13.112	40.00	48.00

3 Metre Long White Hydropanel

Description	Colour	Code	£ Ex VAT	£ Inc VAT
PVC Hydropanel pack of 4 x 3m long	White	13.122	46.00	55.20

As with all decorative products differences in shading can occur between batches. Please ensure you order enough for the job in hand and also ensure that shades and colours are checked and approved on site before installation commences.

PVC Widepanel

PVC WIDEPANELS



NB: Widepanels 1000mm wide. Shown above Black Marble.

Ideal for walls and ceilings in bathrooms, showers and kitchens

- 1000mm wide tongue and groove Widepanels
- Wetroom Widepanels for all showers
- Suitable for wet and dry areas
- Suitable for both walls and ceilings
- Easy installation, no wet trades required
- Non-porous and mould free
- Full range of accessories
- Hygienic wipe clean surface
- Virtually maintenance free
- PVC Widepanels are 2400mm high by 1000mm wide
- Profiles are 2400mm long (Can vary by up to 2%)
- H-joint decor strips available in white and silver
- No tiling or grouting to discolour or leak
- Excellent insulation and sound proofing
- 10.5mm thickness
- Class 1 fire rated for commercial and domestic installations
- Light and easy to fit
- 100% waterproof. No water can be drawn into the core
- Made of recyclable PVC
- Is strong and rigid
- Accessories can be screwed securely onto PVC Widepanels

PVC Widepanel

Hardwearing PVC surface suitable for all areas domestic and commercial



Marble Cream

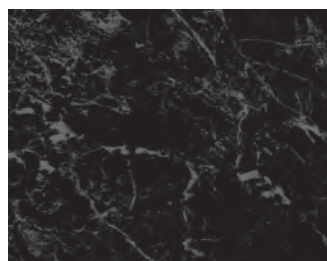

Black Marble Gloss

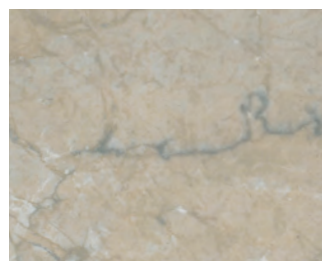

Travertine Gloss

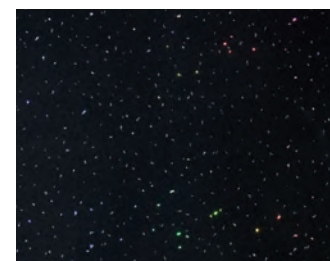

Black Sparkle

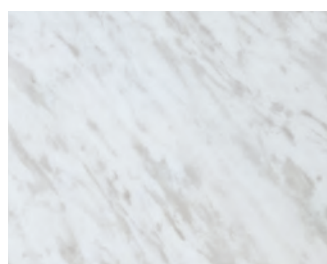

Carrara Marble



Marble Blue

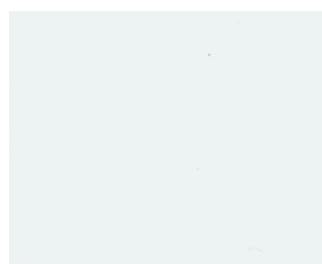

White

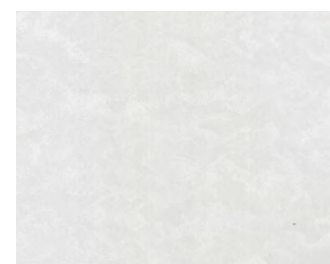

Pearl White



White Sparkle



Mother Of Pearl

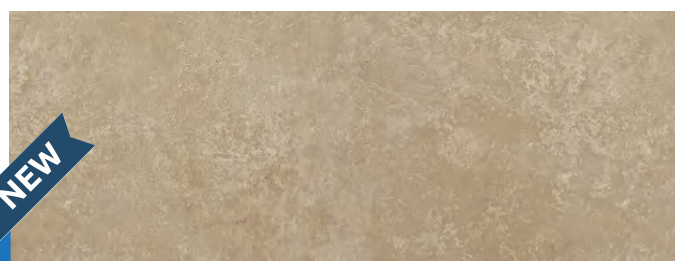

Concrete Beige Matt

NB: All panels are 1000mm wide.

PVC Widepanel 1000 x 2400mm			
Colour	Code	£ Ex VAT	£ Inc VAT
Marble blue Gloss	13.502	113.00	135.60
Carrara marble Gloss	13.504	113.00	135.60
Marble cream Gloss	13.507	113.00	135.60
White Gloss	13.512	113.00	135.60
Mother of Pearl	13.516	113.00	135.60
Travertine	13.520	113.00	135.60
Pearl White	13.521	113.00	135.60
Black Marble Gloss	13.522	113.00	135.60
Black Sparkle	13.523	120.00	144.00
White Sparkle	13.524	120.00	144.00
Concrete Beige Matt	13.525	113.00	135.60

NB: Panels - range from 2400-2430 height

Colours are subject to the limitations of the printing process, and should only be used as a guide to colour matching.

NB: As with all decorative products differences in shading can occur between batches.

Please ensure you order enough to complete the job in hand and also ensure that shades and colours are checked and approved on site before installation commences.

PVC Profiles			
Description	White	£ Ex VAT	£ Inc VAT
PVC Widepanel internal corner	13.311	13.00	15.60
PVC Widepanel external corner	13.312	14.00	16.80
PVC Widepanel end U	13.313	9.00	10.80
PVC Widepanel join H	13.316	12.00	14.40

Aluminium Profiles			
Description	Bright Silver	£ Ex VAT	£ Inc VAT
Widepanel aluminium internal	32.311	29.00	34.80
Widepanel aluminium external	32.312	33.00	39.60
Widepanel aluminium end U	32.313	26.00	31.20
Widepanel aluminium join H	32.314	27.00	32.40

- FEATURES**
- PVC Class 1 fire rated
 - Lightweight only 12.5 Kg
 - Water resistant
 - Easy clean surface
 - Eco friendly recycled PVC used



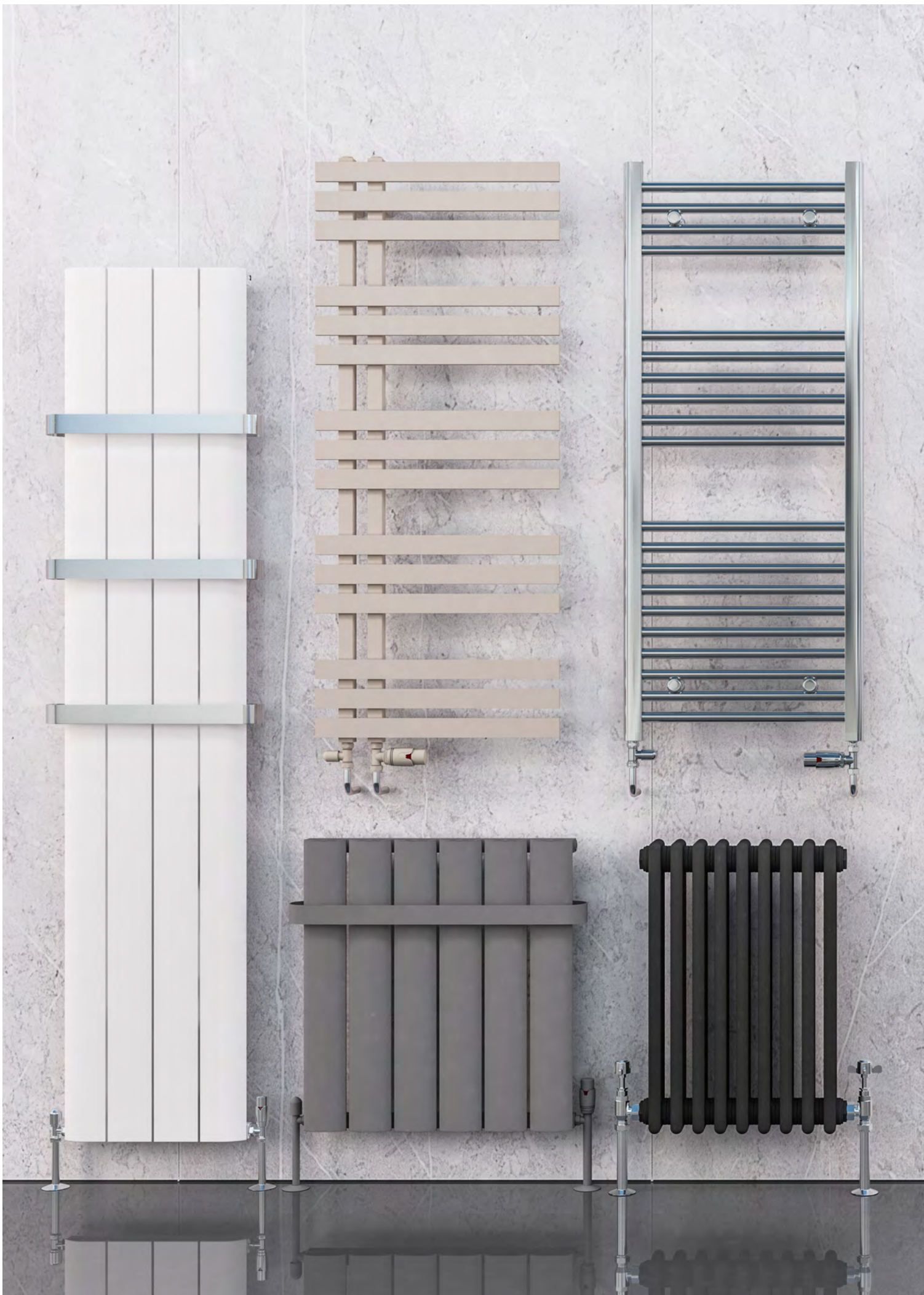

Heated Towel Rails & Radiators

A huge variety of towel rails and radiators from modern to traditional, available in steel, aluminium and stainless steel.

There are a great choice of colours including gloss white, chrome, matt white, matt grey, matt cappuccino, matt anthracite, matt black & polished aluminium. Most of our towel rails and radiators can be powered via dual fuel, single fuel and / or all electric.

Contents

The Multirail Range	494 - 524
The Designer Range	525 - 563
The Aluminium Range	564 - 612
The Stainless Steel Range	613 - 615
The Traditional Range	616 - 627
Elements	628 - 629
Valves	630 - 634
Accessories	635 - 637
Bespoke Colours & Sizes	638 - 639

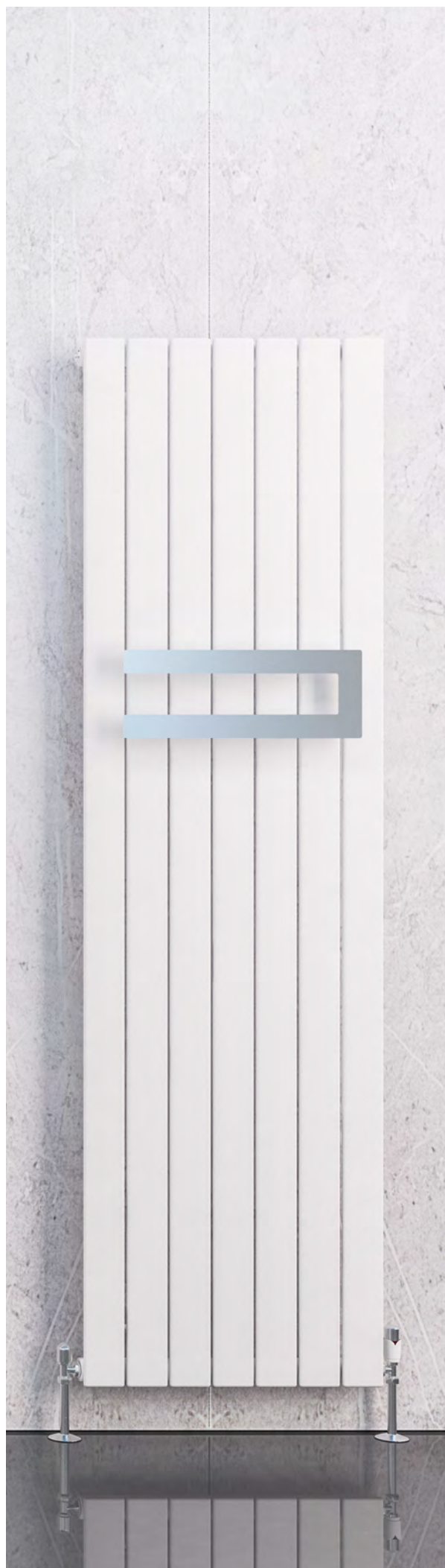

Multirail Range

WENDOVER - STRAIGHT, CHROME



Pictured 41.0245 Chrome

A modern ladder towel rail, available in a vast array of sizes including 600mm high by 1200mm wide, as pictured above, which is ideal for under-window situation. The Wendover range is available in chrome, white and matt anthracite, along with matching radiator valves and pipe shrouds.

Wendover - Straight Chrome 360mm Height

Size H x W	Watts	BTU	Element Output	Element Type	Code	£ Ex VAT	£ Inc VAT
360 x 400mm	112	347	N/A	N/A	41.0267	42.00	50.40

Wendover - Straight Chrome 600mm Height

Size H x W	Watts	BTU	Element Output	Element Type	Code	£ Ex VAT	£ Inc VAT
600 x 300mm	155	529	100W	A, D, E or F	41.0085	54.00	64.80
600 x 400mm	190	648	100W	A, D, E or F	41.0082	58.00	69.60
600 x 500mm	225	768	150W	A, D, E or F	41.0083	62.00	74.40
600 x 600mm	260	887	150W	A, D, E or F	41.0084	67.00	80.40
600 x 750mm	313	1068	150W	A, D, E or F	41.0076	76.00	91.20
600 x 1000mm	401	1368	150W	A, D, E or F	41.0244	116.00	139.20
600 x 1200mm	472	1610	300W	A, D, E or F	41.0245	129.00	154.80

FEATURES

- 22mm diameter horizontal round tubes.
- Manufactured and tested to EN442 standard
- CE and NF certificates
- 5 Year Manufacturer's Warranty*
- Can be single, dual fuel, or all electric
- * With conditions

Warranty

5

Year

Diameter (∅)

22

MM Bars

Heating

All Electric

Dual-Fuel



Multirail Range

Wendover - Straight Chrome 800mm Height

Size H x W	Watts	BTU	Element Output	Element Type	Code	£ Ex VAT	£ Inc VAT
800 x 300mm	211	720	100W	A, D, E or F	41.0086	65.00	78.00
800 x 400mm	260	887	150W	A, D, E or F	41.0001	69.00	82.80
800 x 500mm	309	1054	150W	A, D, E or F	41.0003	74.00	88.80
800 x 600mm	359	1225	150W	A, D, E or F	41.0005	79.00	94.80
800 x 750mm	433	1477	150W	A, D, E or F	41.0077	98.00	117.60

Wendover - Straight Chrome 1000mm Height

Size H x W	Watts	BTU	Element Output	Element Type	Code	£ Ex VAT	£ Inc VAT
1000 x 300mm	251	856	150W	A, D, E or F	41.0087	75.00	90.00
1000 x 400mm	308	1051	150W	A, D, E or F	41.0007	79.00	94.80
1000 x 500mm	364	1242	150W	A, D, E or F	41.0009	86.00	103.20
1000 x 600mm	421	1436	150W	A, D, E or F	41.0011	92.00	110.40
1000 x 750mm	506	1726	300W	A, D, E or F	41.0078	112.00	134.40

Wendover - Straight Chrome 1200mm Height

Size H x W	Watts	BTU	Element Output	Element Type	Code	£ Ex VAT	£ Inc VAT
1200 x 300mm	308	1051	150W	A, D, E or F	41.0088	89.00	106.80
1200 x 400mm	379	1293	150W	A, D, E or F	41.0013	92.00	110.40
1200 x 500mm	450	1535	150W	A, D, E or F	41.0015	100.00	120.00
1200 x 600mm	554	1890	300W	A, D, E or F	41.0017	109.00	130.80
1200 x 750mm	626	2136	300W	A, D, E or F	41.0079	134.00	160.80

WENDOVER - STRAIGHT, CHROME

Wendover - Straight Chrome 1600mm Height

Size H x W	Watts	BTU	Element Output	Element Type	Code	£ Ex VAT	£ Inc VAT
1600 x 300mm	406	1385	150W	A, D, E or F	41.0089	110.00	132.00
1600 x 400mm	497	1696	300W	A, D, E or F	41.0019	116.00	139.20
1600 x 500mm	589	2010	300W	A, D, E or F	41.0021	126.00	151.20
1600 x 600mm	681	2324	300W	A, D, E or F	41.0023	137.00	164.40
1600 x 750mm	819	2794	300W	A, D, E or F	41.0080	171.00	205.20

Wendover - Straight Chrome 1800mm Height

Size H x W	Watts	BTU	Element Output	Element Type	Code	£ Ex VAT	£ Inc VAT
1800 x 300mm	462	1576	150W	A, D, E or F	41.0090	123.00	147.60
1800 x 400mm	568	1938	300W	A, D, E or F	41.0025	129.00	154.80
1800 x 500mm	675	2303	300W	A, D, E or F	41.0027	142.00	170.40
1800 x 600mm	780	2661	300W	A, D, E or F	41.0029	154.00	184.80
1800 x 750mm	940	3207	300W	A, D, E or F	41.0081	191.00	229.20

Round Vent Caps
Page 637

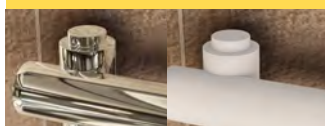

Robe Hooks
Page 636



Towel Hangers
Page 636



Multi-Rail Hangers
Page 635



TECHNICAL INFORMATION

All measurements in Height by Width. Heat output based on $\Delta T60^{\circ}C$. Radiators that are electric only are restricted to the heat output of the elements. Element size can be increased to full capacity of rail if using element type D, E or F. For element types see pages 628-629. For matching valves see pages 630-634. For indirect heating systems only. Tappings are approx. 50mm less than the width of the rail and approx. 70mm off the wall. Price includes radiator and wall fixing sets, valves extra.

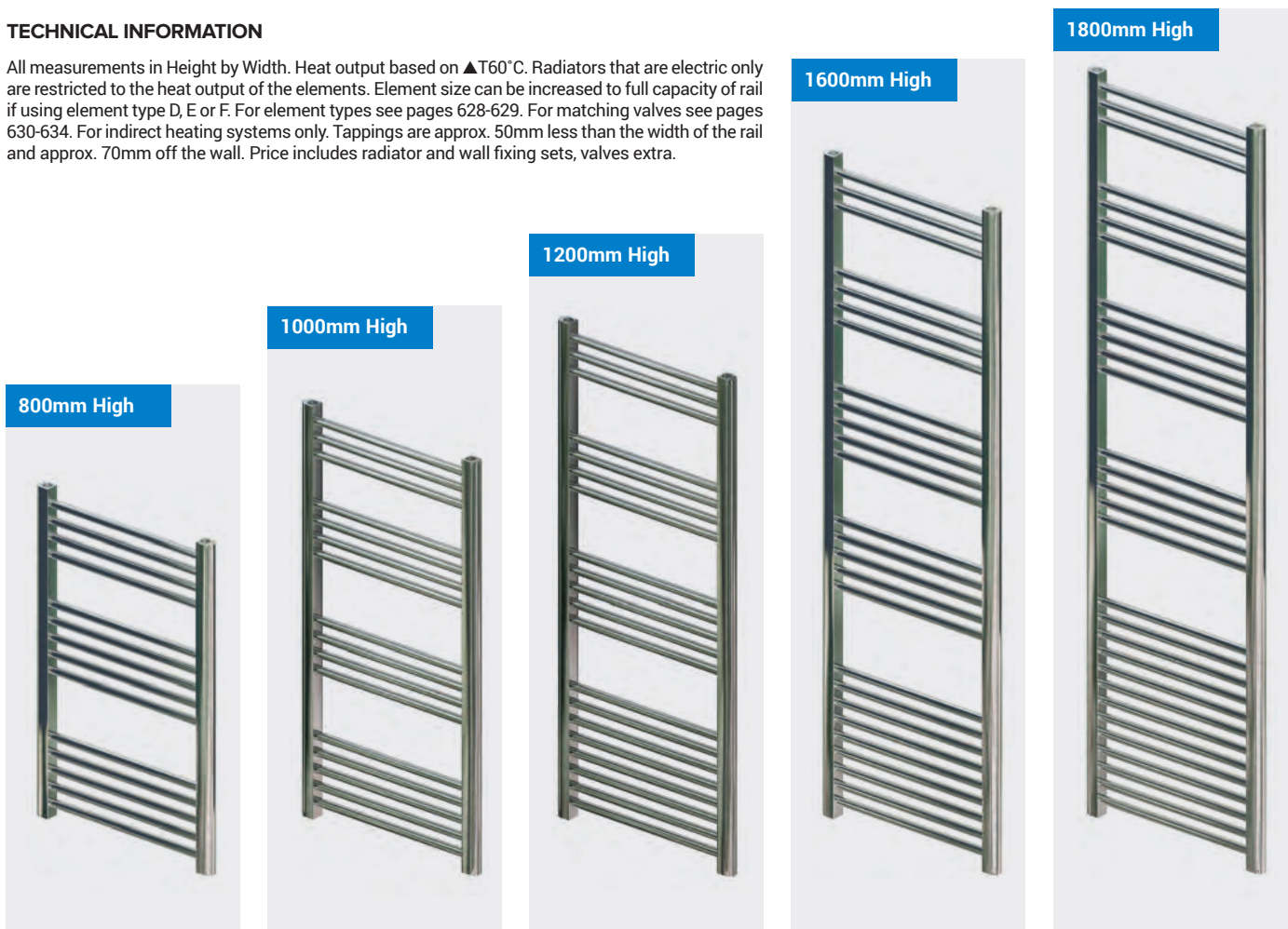

Multirail Range

WENDOVER - CURVED, CHROME





Pictured 41.0035 Chrome

A modern ladder towel rail, with a range of sizes available, from 600 x 400mm to 1800 x 750mm. Available in straight and curved options as well as chrome, white and matt anthracite finishes.

FEATURES

- 22mm diameter horizontal round tubes.
- Manufactured and tested to EN442 standard
- CE and NF certificates
- 5 Year Manufacturer's Warranty*
- Can be single, dual fuel, or all electric

* With conditions

<p>Warranty</p> <p>5</p> <p>Year</p>	<p>Diameter (Ø)</p> <p>22</p> <p>MM Bars</p>	<p>Heating</p> 	<p>All Electric</p> 	<p>Dual-Fuel</p> 
---	---	--	---	--

800mm High



600mm High



Multirail Range

Wendover - Curved Chrome 600mm Height							
Size H x W	Watts	BTU	Element Output	Element Type	Code	£ Ex VAT	£ Inc VAT
600 x 400mm	190	648	100W	A, D, E or F	41.0106	59.00	70.80
600 x 500mm	225	768	100W	A, D, E or F	41.0107	63.00	75.60
600 x 600mm	260	887	150W	A, D, E or F	41.0108	69.00	82.80
600 x 750mm	313	1068	150W	A, D, E or F	41.0100	79.00	94.80

Wendover - Curved Chrome 800mm Height							
Size H x W	Watts	BTU	Element Output	Element Type	Code	£ Ex VAT	£ Inc VAT
800 x 400mm	263	897	150W	A, D, E or F	41.0031	71.00	85.20
800 x 500mm	312	1065	150W	A, D, E or F	41.0033	75.00	90.00
800 x 600mm	361	1232	150W	A, D, E or F	41.0035	82.00	98.40
800 x 750mm	433	1477	150W	A, D, E or F	41.0101	101.00	121.20

Wendover - Curved Chrome 1000mm Height							
Size H x W	Watts	BTU	Element Output	Element Type	Code	£ Ex VAT	£ Inc VAT
1000 x 400mm	310	1058	150W	A, D, E or F	41.0037	80.00	96.00
1000 x 500mm	367	1252	150W	A, D, E or F	41.0039	88.00	105.60
1000 x 600mm	423	1443	150W	A, D, E or F	41.0041	94.00	112.80
1000 x 750mm	506	1726	300W	A, D, E or F	41.0102	116.00	139.20

WENDOVER - CURVED, CHROME							
Wendover - Curved Chrome 1200mm Height							
Size H x W	Watts	BTU	Element Output	Element Type	Code	£ Ex VAT	£ Inc VAT
1200 x 400mm	382	1303	150W	A, D, E or F	41.0043	94.00	112.80
1200 x 500mm	452	1542	150W	A, D, E or F	41.0045	103.00	123.60
1200 x 600mm	523	1784	300W	A, D, E or F	41.0047	111.00	133.20
1200 x 750mm	626	2136	300W	A, D, E or F	41.0103	138.00	165.60

Wendover - Curved Chrome 1600mm Height							
Size H x W	Watts	BTU	Element Output	Element Type	Code	£ Ex VAT	£ Inc VAT
1600 x 400mm	501	1709	300W	A, D, E or F	41.0049	120.00	144.00
1600 x 500mm	593	2023	300W	A, D, E or F	41.0051	131.00	157.20
1600 x 600mm	685	2337	300W	A, D, E or F	41.0053	141.00	169.20
1600 x 750mm	819	2794	300W	A, D, E or F	41.0104	175.00	210.00

Wendover - Curved Chrome 1800mm Height							
Size H x W	Watts	BTU	Element Output	Element Type	Code	£ Ex VAT	£ Inc VAT
1800 x 400mm	573	1955	300W	A, D, E or F	41.0055	134.00	160.80
1800 x 500mm	678	2313	300W	A, D, E or F	41.0057	146.00	175.20
1800 x 600mm	784	2675	300W	A, D, E or F	41.0059	159.00	190.80
1800 x 750mm	940	3207	300W	A, D, E or F	41.0105	198.00	237.60

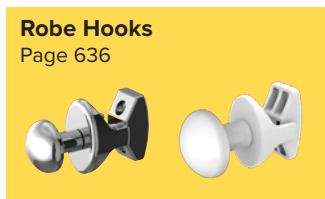
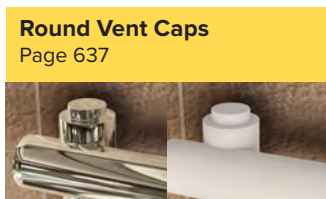

TECHNICAL INFORMATION

All measurements in Height by Width. Heat output based on $\Delta T60^{\circ}\text{C}$. Radiators that are electric only are restricted to the heat output of the elements. Element size can be increased to full capacity of rail if using element type D, E or F. For element types see pages 628-629. For matching valves see pages 630-634. For indirect heating systems only. Tappings are approx. 50mm less than the width of the rail and approx. 70mm off the wall. Price includes radiator and wall fixing sets, valves extra.



Multirail Range

WENDOVER - STRAIGHT, WHITE



Pictured 41.0028 White

A modern ladder towel rail, with a range of sizes available including 360 x 400mm to 1800 x 750mm. Available in straight and curved options as well as chrome, white and matt anthracite finishes.

FEATURES

- 22mm diameter horizontal round tubes.
- Manufactured and tested to EN442 standard
- CE and NF certificates
- 5 Year Manufacturer's Warranty*
- Can be single, dual fuel, or all electric

* With conditions

Warranty

5
Year

Diameter (Ø)

22
MM Bars

Heating



All Electric



Dual-Fuel



Wendover - Straight White 360mm Height

Size H x W	Watts	BTU	Element Output	Element Type	Code	£ Ex VAT	£ Inc VAT
360 x 400mm	112	423	N/A	N/A	41.0266	27.00	32.40

Wendover - Straight White 600mm Height

Size H x W	Watts	BTU	Element Output	Element Type	Code	£ Ex VAT	£ Inc VAT
600 x 300mm	196	669	100W	A, D, E or F	41.0070	32.00	38.40
600 x 400mm	241	822	150W	A, D, E or F	41.0067	34.00	40.80
600 x 500mm	285	972	150W	A, D, E or F	41.0068	36.00	43.20
600 x 600mm	330	1126	150W	A, D, E or F	41.0069	38.00	45.60
600 x 750mm	397	1355	150W	A, D, E or F	41.0061	45.00	54.00
600 x 1000mm	510	1740	300W	A, D, E or F	41.0246	67.00	80.40
600 x 1200mm	600	2047	300W	A, D, E or F	41.0247	72.00	86.40

Wendover - Straight White 800mm Height

Size H x W	Watts	BTU	Element Output	Element Type	Code	£ Ex VAT	£ Inc VAT
800 x 300mm	267	911	150W	A, D, E or F	41.0071	37.00	44.40
800 x 400mm	330	1126	150W	A, D, E or F	41.0002	39.00	46.80
800 x 500mm	394	1344	150W	A, D, E or F	41.0004	42.00	50.40
800 x 600mm	457	1559	300W	A, D, E or F	41.0006	45.00	54.00
800 x 750mm	551	1880	300W	A, D, E or F	41.0062	55.00	66.00

Wendover - Straight White 1000mm Height

Size H x W	Watts	BTU	Element Output	Element Type	Code	£ Ex VAT	£ Inc VAT
1000 x 300mm	320	1092	150W	A, D, E or F	41.0072	44.00	52.80
1000 x 400mm	392	1338	150W	A, D, E or F	41.0008	45.00	54.00
1000 x 500mm	464	1583	150W	A, D, E or F	41.0010	48.00	57.60
1000 x 600mm	535	1825	300W	A, D, E or F	41.0012	52.00	62.40
1000 x 750mm	643	2194	300W	A, D, E or F	41.0063	62.00	74.40

Wendover - Straight White 1200mm Height

Size H x W	Watts	BTU	Element Output	Element Type	Code	£ Ex VAT	£ Inc VAT
1200 x 300mm	392	1338	150W	A, D, E or F	41.0073	50.00	60.00
1200 x 400mm	482	1645	300W	A, D, E or F	41.0014	52.00	62.40
1200 x 500mm	571	1948	300W	A, D, E or F	41.0016	55.00	66.00
1200 x 600mm	661	2255	300W	A, D, E or F	41.0018	59.00	70.80
1200 x 750mm	796	2716	300W	A, D, E or F	41.0064	73.00	87.60

Wendover - Straight White 1600mm Height

Size H x W	Watts	BTU	Element Output	Element Type	Code	£ Ex VAT	£ Inc VAT
1600 x 300mm	516	1761	300W	A, D, E or F	41.0074	60.00	72.00
1600 x 400mm	632	2156	300W	A, D, E or F	41.0020	63.00	75.60
1600 x 500mm	749	2556	300W	A, D, E or F	41.0022	69.00	82.80
1600 x 600mm	867	2958	300W	A, D, E or F	41.0024	74.00	88.80
1600 x 750mm	1041	3552	600W	A, D, E or F	41.0065	91.00	109.20

Wendover - Straight White 1800mm Height

Size H x W	Watts	BTU	Element Output	Element Type	Code	£ Ex VAT	£ Inc VAT
1800 x 300mm	588	2006	300W	A, D, E or F	41.0075	67.00	80.40
1800 x 400mm	723	2467	300W	A, D, E or F	41.0026	71.00	85.20
1800 x 500mm	856	2921	300W	A, D, E or F	41.0028	76.00	91.20
1800 x 600mm	991	3381	600W	A, D, E or F	41.0030	83.00	99.60
1800 x 750mm	1193	4071	600W	A, D, E or F	41.0066	102.00	122.40

Round Vent Caps

Page 637

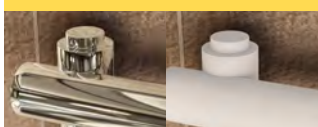

Robe Hooks

Page 636

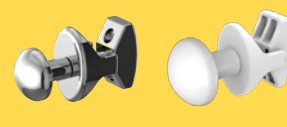

Towel Hangers

Page 636



Multi-Rail Hangers

Page 635



Multirail Range



Pictured 41.0036 White

A modern ladder towel rail, with a range of sizes available including 600 x 400mm to 1800 x 750mm. Available in straight and curved options as well as chrome, white and matt anthracite finishes.

FEATURES

- 22mm diameter horizontal round tubes.
- Manufactured and tested to EN442 standard
- CE and NF certificates
- 5 Year Manufacturer's Warranty*
- Can be single, dual fuel, or all electric
- * With conditions

Warranty	Diameter (Ø)	Heating	All Electric	Dual-Fuel
5 Year	22 MM Bars			

WENDOVER - CURVED, WHITE

Wendover - Straight White 600mm Height

Size H x W	Watts	BTU	Element Output	Element Type	Code	£ Ex VAT	£ Inc VAT
600 x 400mm	241	822	150W	A, D, E or FF	41.0097	35.00	42.00
600 x 500mm	285	972	150W	A, D, E or F	41.0098	37.00	44.40
600 x 600mm	330	1126	150W	A, D, E or F	41.0099	39.00	46.80
600 x 750mm	397	1355	150W	A, D, E or F	41.0091	46.00	55.20

Wendover - Straight White 800mm Height

Size H x W	Watts	BTU	Element Output	Element Type	Code	£ Ex VAT	£ Inc VAT
800 x 400mm	333	1136	150W	A, D, E or F	41.0032	41.00	49.20
800 x 500mm	396	1351	150W	A, D, E or F	41.0034	44.00	52.80
800 x 600mm	459	1566	150W	A, D, E or F	41.0036	47.00	56.40
800 x 750mm	551	1880	300W	A, D, E or F	41.0092	56.00	67.20

Wendover - Straight White 1000mm Height

Size H x W	Watts	BTU	Element Output	Element Type	Code	£ Ex VAT	£ Inc VAT
1000 x 400mm	395	1348	150W	A, D, E or F	41.0038	46.00	55.20
1000 x 500mm	467	1593	150W	A, D, E or F	41.0040	50.00	60.00
1000 x 600mm	539	1839	300W	A, D, E or F	41.0042	53.00	63.60
1000 x 750mm	643	2194	300W	A, D, E or F	41.0093	63.00	75.60

Wendover - Straight White 1200mm Height

Size H x W	Watts	BTU	Element Output	Element Type	Code	£ Ex VAT	£ Inc VAT
1200 x 400mm	486	1658	300W	A, D, E or F	41.0044	53.00	63.60
1200 x 500mm	575	1962	300W	A, D, E or F	41.0046	57.00	68.40
1200 x 600mm	665	2269	300W	A, D, E or F	41.0048	61.00	73.20
1200 x 750mm	796	2716	300W	A, D, E or F	41.0094	75.00	90.00

Wendover - Straight White 1600mm Height

Size H x W	Watts	BTU	Element Output	Element Type	Code	£ Ex VAT	£ Inc VAT
1600 x 400mm	637	2173	300W	A, D, E or F	41.0050	65.00	78.00
1600 x 500mm	754	2573	300W	A, D, E or F	41.0052	71.00	85.20
1600 x 600mm	870	2968	300W	A, D, E or F	41.0054	76.00	91.20
1600 x 750mm	1041	3552	600W	A, D, E or F	41.0095	94.00	112.80

Wendover - Straight White 1800mm Height

Size H x W	Watts	BTU	Element Output	Element Type	Code	£ Ex VAT	£ Inc VAT
1800 x 400mm	728	2484	300W	A, D, E or F	41.0056	72.00	86.40
1800 x 500mm	863	2945	300W	A, D, E or F	41.0058	79.00	94.80
1800 x 600mm	998	3405	600W	A, D, E or F	41.0060	86.00	103.20
1800 x 750mm	1193	4071	600W	A, D, E or F	41.0096	104.00	124.80

TECHNICAL INFORMATION

All measurements in Height by Width. Heat output based on $\Delta T60^{\circ}\text{C}$. Radiators that are electric only are restricted to the heat output of the elements. Element size can be increased to full capacity of rail if using element type D, E or F. For element types see pages 628-629. For matching valves see pages 630-634. For indirect heating systems only. Tappings are approx. 50mm less than the width of the rail and approx. 70mm off the wall. Price includes radiator and wall fixing sets, valves extra.

Round Vent Caps

Page 637



Robe Hooks

Page 636

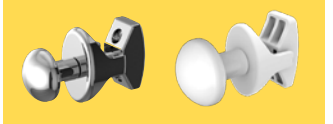

Multirail Range

WENDOVER - STRAIGHT MATT ANTHRACITE

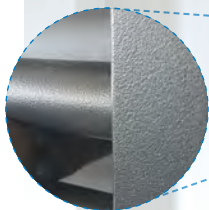

Pictured 41.0326 Matt Anthracite

A modern ladder towel rail in a stunning matt anthracite finish. This rail will add a touch of class to finish off your bathroom.

FEATURES

- 22mm diameter horizontal round tubes.
 - Manufactured and tested to EN442 standard
 - CE and NF certificates
 - 5 Year manufacturer's warranty*
 - Can be single or dual fuel, or all electric
- * With conditions

Wendover - Straight Matt Anthracite							
Size H x W	Watts	BTU	Element Output	Element Type	Code	£ Ex VAT	£ Inc VAT
600 x 400mm	241	822	150W	A, D, E or F	41.0320	36.00	43.20
600 x 500mm	285	972	150W	A, D, E or F	41.0321	38.00	45.60
600 x 600mm	330	1126	150W	A, D, E or F	41.0322	41.00	49.20
1200 x 400mm	482	1645	300W	A, D, E or F	41.0323	55.00	66.00
1200 x 500mm	571	1948	300W	A, D, E or F	41.0324	58.00	69.60
1200 x 600mm	661	2255	300W	A, D, E or F	41.0325	62.00	74.40
1800 x 500mm	856	2921	300W	A, D, E or F	41.0326	82.00	98.40
1800 x 600mm	991	3381	600W	A, D, E or F	41.0327	88.00	105.60

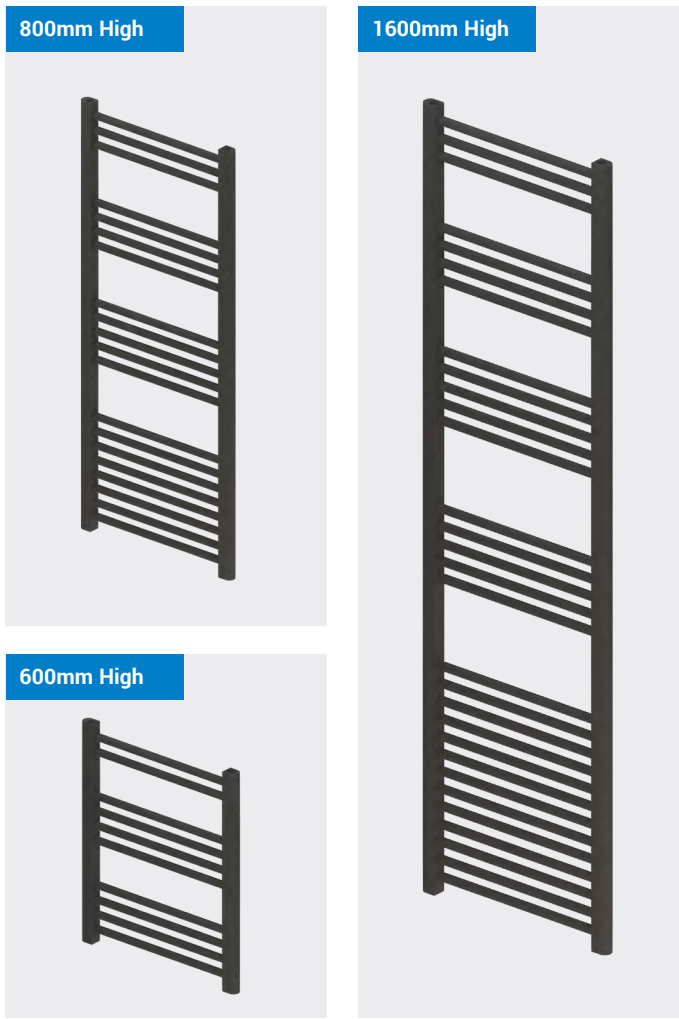

TECHNICAL INFORMATION

All measurements in Height by Width. Heat output based on $\Delta T60^{\circ}C$. Radiators that are electric only are restricted to the heat output of the elements. Element size can be increased to full capacity of rail if using element type D, E or F. For element types see pages 628-629. For matching valves see pages 630-634. For indirect heating systems only. Tappings are approx. 50mm less than the width of the rail and approx. 70mm off the wall. Price includes radiator and wall fixing sets, valves extra.

Round Vent Caps

Page 637



Robe Hooks

Page 636

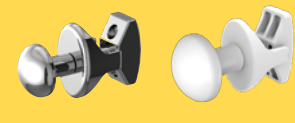

Towel Hangers

Page 636



Multi-Rail Hangers

Page 635



Warranty

5

Year

Diameter (Ø)

22

MM Bars

Heating

All Electric

Dual-Fuel

Multirail Range



Pictured 41.0317 White



Pictured 41.0309 Chrome

A simple design straight ladder rail which is the ideal combination of modern style and practicality. The range includes chrome and white options in a range of sizes.

FEATURES

- 22mm diameter horizontal round tubes.
- Manufactured and tested to EN442 standard
- CE and NF certificates
- 5 Year manufacturer's warranty*
- Can be single or dual fuel, or all electric
- * With conditions

TECHNICAL INFORMATION

All measurements in Height by Width. Heat output based on $\Delta T60^{\circ}\text{C}$. Radiators that are electric only are restricted to the heat output of the elements. Element size can be increased to full capacity of rail if using element type D, E or F. For element types see pages 628-629. For matching valves see pages 630-634. For indirect heating systems only. Tappings are approx. 50mm less than the width of the rail and approx. 75mm off the wall. Price includes radiator and wall fixing sets, valves extra.

Warranty

5

Year

Diameter (Ø)

22

MM Bars

Heating

All Electric

Dual-Fuel

Round Vent Caps
Page 637



Tuscan - White							
Size H x W	Watts	BTU	Element Output	Element Type	Code	£ Ex VAT	£ Inc VAT
650 x 450mm	180	614	100W	A, D, E or F	41.0314	35.00	42.00
650 x 600mm	212	723	100W	A, D, E or F	41.0315	39.00	46.80
1200 x 450mm	315	1075	150W	A, D, E or F	41.0316	48.00	57.60
1200 x 600mm	365	1245	150W	A, D, E or F	41.0317	52.00	62.40
1750 x 450mm	464	1583	300W	A, D, E or F	41.0318	63.00	75.60
1750 x 600mm	537	1832	300W	A, D, E or F	41.0319	66.00	79.20

Tuscan - Chrome							
Size H x W	Watts	BTU	Element Output	Element Type	Code	£ Ex VAT	£ Inc VAT
650 x 450mm	142	485	100W	A, D, E or F	41.0308	51.00	61.20
650 x 600mm	166	566	100W	A, D, E or F	41.0309	56.00	67.20
1200 x 450mm	247	843	150W	A, D, E or F	41.0310	80.00	96.00
1200 x 600mm	286	976	150W	A, D, E or F	41.0311	87.00	104.40
1750 x 450mm	366	1249	150W	A, D, E or F	41.0312	110.00	132.00
1750 x 600mm	423	1443	150W	A, D, E or F	41.0313	119.00	142.80

Multirail Range

WINGRAVE - STRAIGHT, CHROME

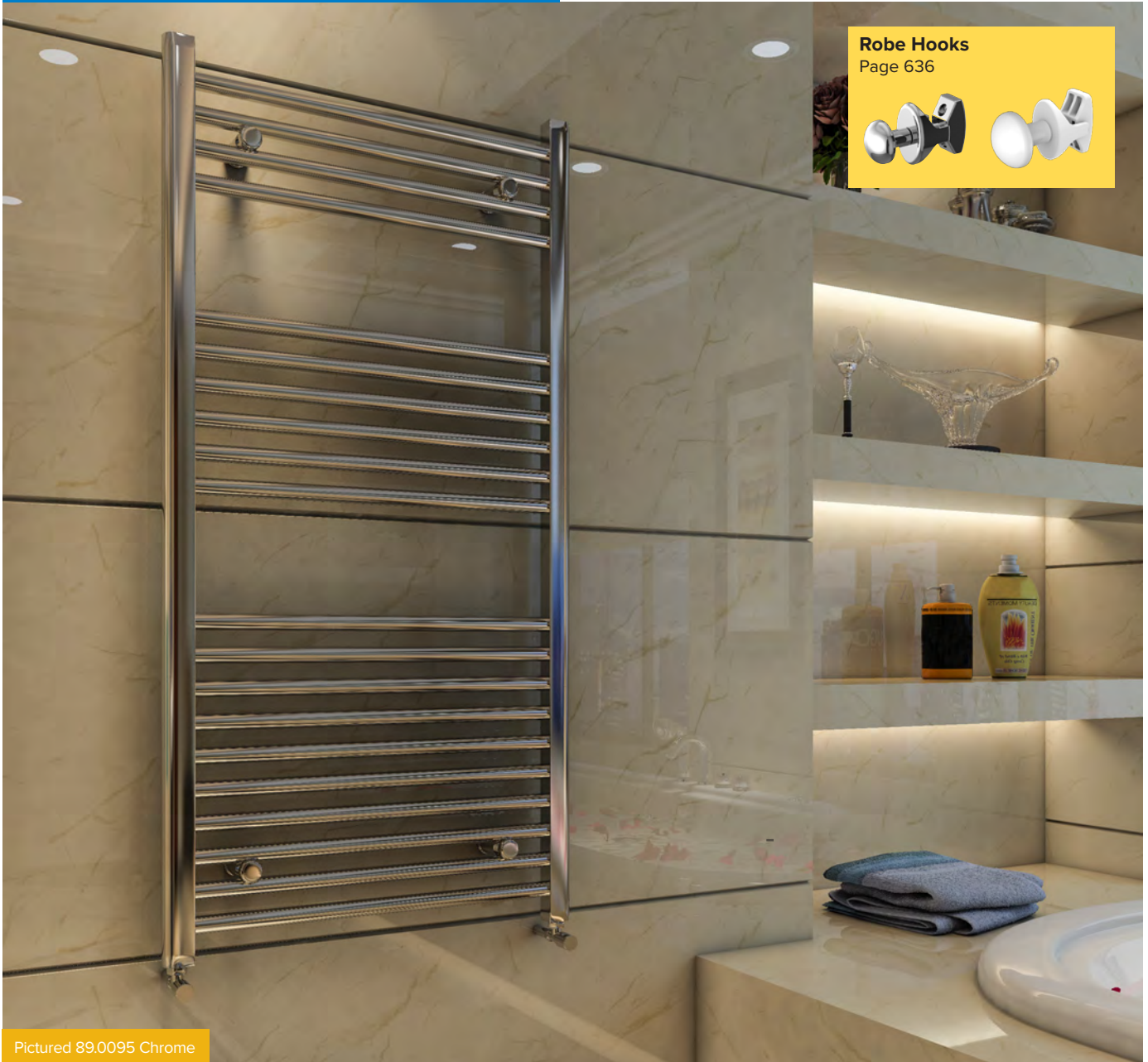

Pictured 89.0095 Chrome

A contemporary straight towel radiator range which comes in chrome, matt anthracite, gloss white and matt white finishes. In a wide variety of sizes this range not only adds to your bathroom with design simplicity but also keeps your towels warm.

FEATURES

- 22mm diameter horizontal round tubes.
- Manufactured and tested to EN442 standard
- CE and NF certificates
- 5 Year manufacturer's warranty*
- Can be single or dual fuel, or all electric

* With conditions

<p>Warranty</p> <p>5</p> <p>Year</p>	<p>Diameter (Ø)</p> <p>22</p> <p>MM Bars</p>	<p>Heating</p>	<p>All Electric</p>	<p>Dual-Fuel</p>
---	---	----------------	---------------------	------------------



Multirail Range

Wingrave - Straight Chrome 800mm Height

Size H x W	Watts	BTU	Element Output	Element Type	Code	£ Ex VAT	£ Inc VAT
800 x 400mm	247	844	150W	A, D, E or F	89.0083	59.00	70.80
800 x 500mm	285	1005	150W	A, D, E or F	89.0088	67.00	80.40
800 x 600mm	342	1166	150W	A, D, E or F	89.0093	73.00	87.60

Wingrave - Straight Chrome 1000mm Height

Size H x W	Watts	BTU	Element Output	Element Type	Code	£ Ex VAT	£ Inc VAT
1000 x 400mm	286	975	150W	A, D, E or F	89.0084	70.00	84.00
1000 x 500mm	338	1154	150W	A, D, E or F	89.0089	78.00	93.60
1000 x 600mm	391	1334	150W	A, D, E or F	89.0094	86.00	103.20

Wingrave - Straight Chrome 1200mm Height

Size H x W	Watts	BTU	Element Output	Element Type	Code	£ Ex VAT	£ Inc VAT
1200 x 400mm	351	1197	150W	A, D, E or F	89.0085	82.00	98.40
1200 x 500mm	417	1421	300W	A, D, E or F	89.0090	92.00	110.40
1200 x 600mm	482	1646	300W	A, D, E or F	89.0095	101.00	121.20

WINGRAVE - STRAIGHT, CHROME

Wingrave - Straight Chrome 1400mm Height

Size H x W	Watts	BTU	Element Output	Element Type	Code	£ Ex VAT	£ Inc VAT
1400 x 400mm	395	1348	150W	A, D, E or F	89.0530	104.00	124.80
1400 x 500mm	467	1593	300W	A, D, E or F	89.0531	114.00	136.80
1400 x 600mm	539	1839	300W	A, D, E or F	89.0532	124.00	148.80

Wingrave - Straight Chrome 1600mm Height

Size H x W	Watts	BTU	Element Output	Element Type	Code	£ Ex VAT	£ Inc VAT
1600 x 400mm	459	1567	300W	A, D, E or F	89.0086	109.00	130.80
1600 x 500mm	545	1858	300W	A, D, E or F	89.0091	120.00	144.00
1600 x 600mm	630	2150	300W	A, D, E or F	89.0096	130.00	156.00

Wingrave - Straight Chrome 1800mm Height

Size H x W	Watts	BTU	Element Output	Element Type	Code	£ Ex VAT	£ Inc VAT
1800 x 400mm	524	1789	300W	A, D, E or F	89.0087	122.00	146.40
1800 x 500mm	623	2125	300W	A, D, E or F	89.0092	135.00	162.00
1800 x 600mm	721	2461	300W	A, D, E or F	89.0097	145.00	174.00

D Shape Vent Caps

Page 637



Round Vent Caps

Page 637



Multi-Rail Hangers

Page 635

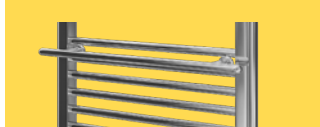

Towel Hangers

Page 636



TECHNICAL INFORMATION

All measurements in Height by Width. Heat output based on $\Delta T 60^{\circ}\text{C}$. Radiators that are electric only are restricted to the heat output of the elements. Element size can be increased to full capacity of rail if using element type D, E or F. For element types see pages 628-629. For matching valves see pages 630-634. For indirect heating systems only. Tappings are approx. 44mm less than the width of the rail and approx. 65mm off the wall. Price includes radiator and wall fixing sets, valves extra.

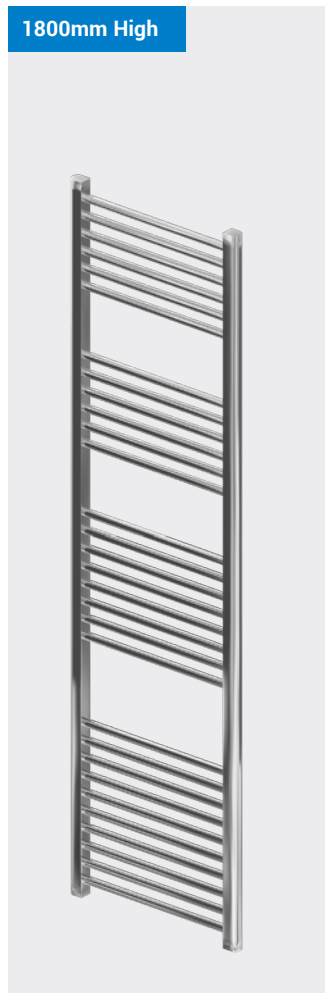
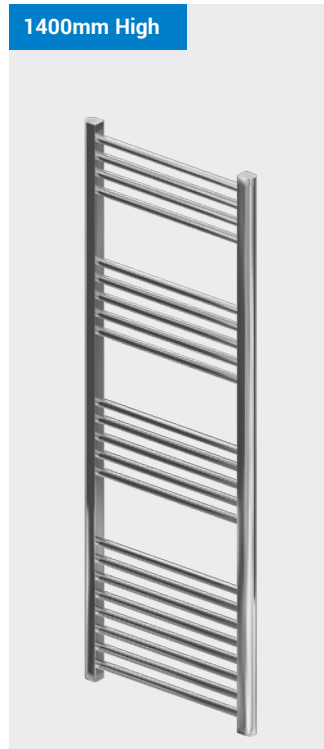

Multirail Range

WINGRAVE - STRAIGHT, MATT ANTHRACITE

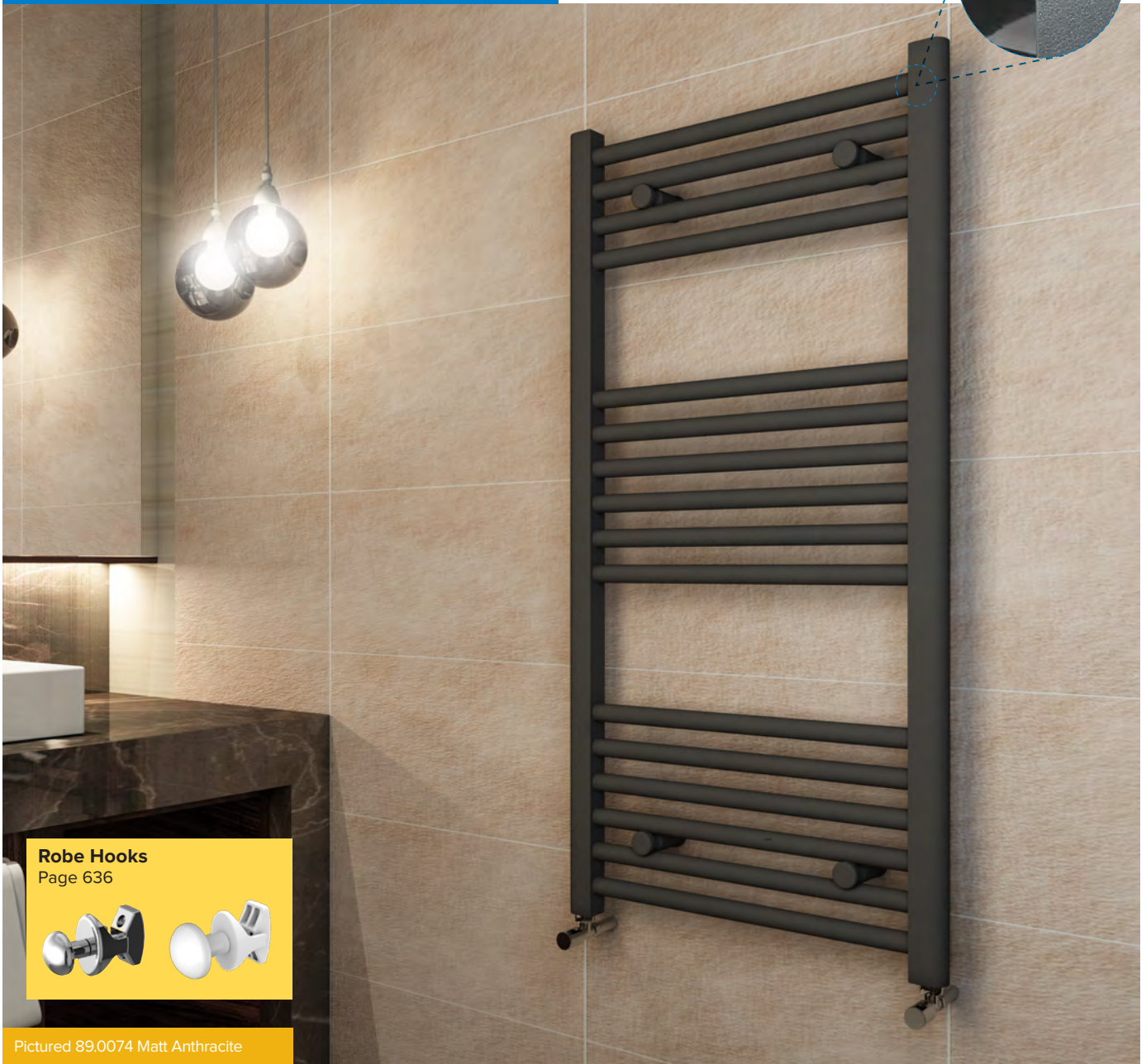

Robe Hooks
Page 636

Pictured 89.0074 Matt Anthracite

A contemporary straight towel radiator range which comes in chrome, matt anthracite, gloss white and matt white finishes. In a wide variety of sizes this range not only adds to your bathroom with design simplicity but also keeps your towels warm.

FEATURES

- 22mm diameter horizontal round tubes.
- Manufactured and tested to EN442 standard
- CE and NF certificates
- 5 Year manufacturer's warranty*
- Can be single or dual fuel, or all electric

* With conditions

<p>Warranty</p> <p>5</p> <p>Year</p>	<p>Diameter (Ø)</p> <p>22</p> <p>MM Bars</p>	<p>Heating</p>	<p>All Electric</p>	<p>Dual-Fuel</p>
---	---	----------------	---------------------	------------------



Multirail Range

Wingrave - Straight Matt Anthracite 800mm Height

Size H x W	Watts	BTU	Element Output	Element Type	Code	£ Ex VAT	£ Inc VAT
800 x 400mm	374	1276	150W	A, D, E or F	89.0068	42.00	50.40
800 x 500mm	445	1518	300W	A, D, E or F	89.0073	46.00	55.20
800 x 600mm	517	1764	300W	A, D, E or F	89.0078	48.00	57.60

Wingrave - Straight Matt Anthracite 1000mm Height

Size H x W	Watts	BTU	Element Output	Element Type	Code	£ Ex VAT	£ Inc VAT
1000 x 400mm	419	1430	150W	A, D, E or F	89.0069	48.00	57.60
1000 x 500mm	496	1692	300W	A, D, E or F	89.0074	52.00	62.40
1000 x 600mm	573	1955	300W	A, D, E or F	89.0079	56.00	67.20

Wingrave - Straight Matt Anthracite 1200mm Height

Size H x W	Watts	BTU	Element Output	Element Type	Code	£ Ex VAT	£ Inc VAT
1200 x 400mm	514	1754	300W	A, D, E or F	89.0070	56.00	67.20
1200 x 500mm	611	2085	300W	A, D, E or F	89.0075	59.00	70.80
1200 x 600mm	708	2416	300W	A, D, E or F	89.0080	63.00	75.60

WINGRAVE - STRAIGHT, MATT ANTHRACITE

Wingrave - Straight Matt Anthracite 1400mm Height

Size H x W	Watts	BTU	Element Output	Element Type	Code	£ Ex VAT	£ Inc VAT
1400 x 400mm	571	1948	300W	A, D, E or F	89.0533	63.00	75.60
1400 x 500mm	676	2307	300W	A, D, E or F	89.0534	68.00	81.60
1400 x 600mm	780	2661	300W	A, D, E or F	89.0535	73.00	87.60

Wingrave - Straight Matt Anthracite 1600mm Height

Size H x W	Watts	BTU	Element Output	Element Type	Code	£ Ex VAT	£ Inc VAT
1600 x 400mm	669	2283	300W	A, D, E or F	89.0071	69.00	82.80
1600 x 500mm	794	2709	300W	A, D, E or F	89.0076	74.00	88.80
1600 x 600mm	918	3132	600W	A, D, E or F	89.0081	78.00	93.60

Wingrave - Straight Matt Anthracite 1800mm Height

Size H x W	Watts	BTU	Element Output	Element Type	Code	£ Ex VAT	£ Inc VAT
1800 x 400mm	764	2607	300W	A, D, E or F	89.0072	75.00	90.00
1800 x 500mm	908	3098	600W	A, D, E or F	89.0077	89.00	106.80
1800 x 600mm	1051	3586	600W	A, D, E or F	89.0082	90.00	108.00

D Shape Vent Caps

Page 637



Round Vent Caps

Page 637

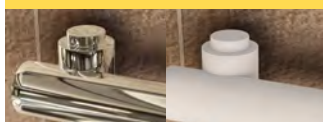

Multi-Rail Hangers

Page 635



Towel Hangers

Page 636



TECHNICAL INFORMATION

All measurements in Height by Width. Heat output based on $\Delta T60^{\circ}C$. Radiators that are electric only are restricted to the heat output of the elements. Element size can be increased to full capacity of rail if using element type D, E or F. For element types see pages 628-629. For matching valves see pages 630-634. For indirect heating systems only. Tappings are approx. 44mm less than the width of the rail and approx. 65mm off the wall. Price includes radiator and wall fixing sets, valves extra.

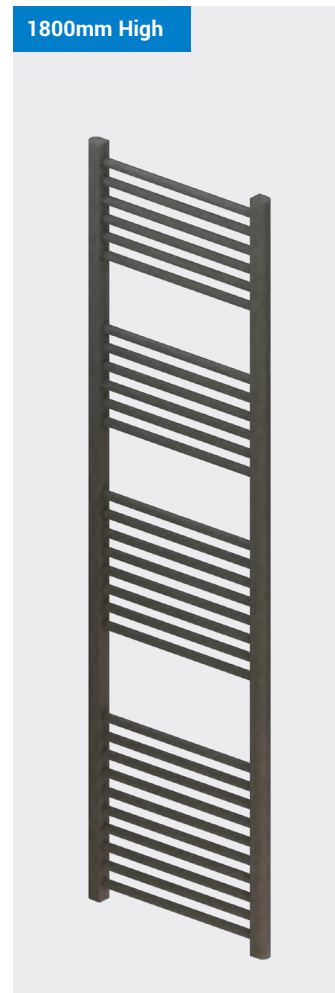
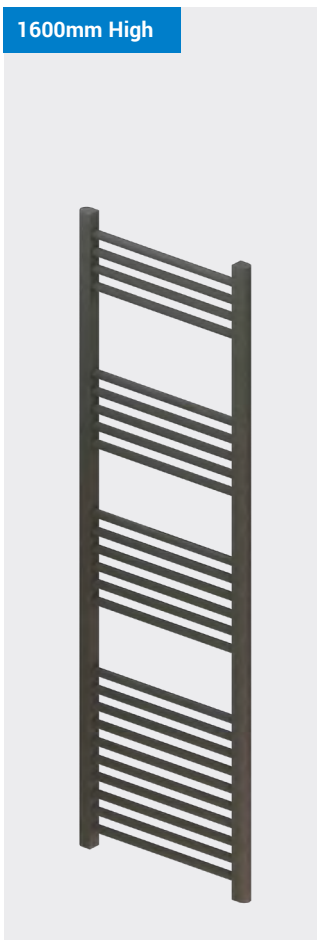
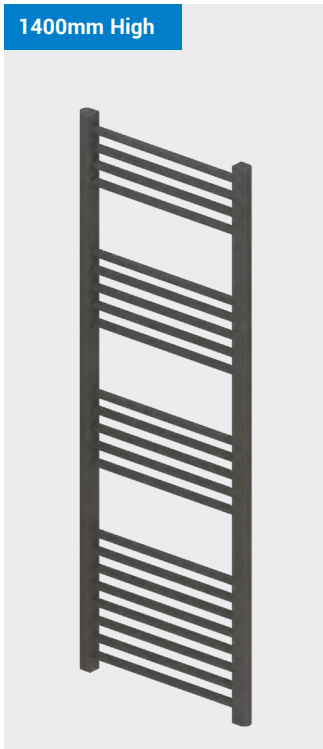
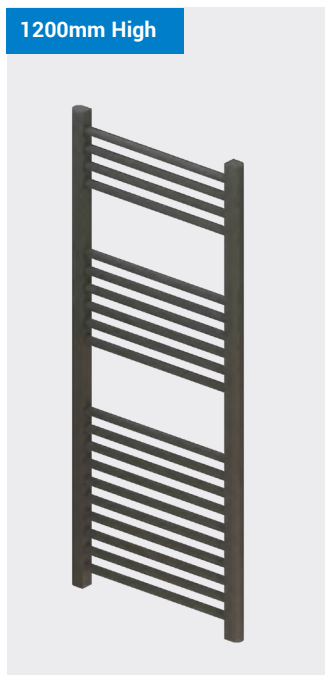

Multirail Range

WINGRAVE - STRAIGHT, GLOSS WHITE



Robe Hooks
Page 636

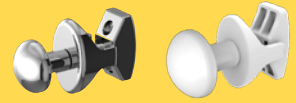

Pictured 89.0127 White

A contemporary straight towel radiator range which comes in chrome, matt anthracite, gloss white and matt white finishes. In a wide variety of sizes this range not only adds to your bathroom with design simplicity but also keeps your towels warm.

FEATURES

- 22mm diameter horizontal round tubes.
- Manufactured and tested to EN442 standard
- CE and NF certificates
- 5 Year manufacturer's warranty*
- Can be single or dual fuel, or all electric

* With conditions

<p>Warranty</p> <p>5</p> <p>Year</p>	<p>Diameter (Ø)</p> <p>22</p> <p>MM Bars</p>	<p>Heating</p>	<p>All Electric</p>	<p>Dual-Fuel</p>
---	---	----------------	---------------------	------------------

800mm High



1000mm High



Multirail Range

Wingrave - Straight Gloss White 800mm Height

Size H x W	Watts	BTU	Element Output	Element Type	Code	£ Ex VAT	£ Inc VAT
800 x 400mm	374	1276	150W	A, D, E or F	89.0113	38.00	45.60
800 x 500mm	445	1518	300W	A, D, E or F	89.0118	41.00	49.20
800 x 600mm	517	1764	300W	A, D, E or F	89.0123	44.00	52.80

Wingrave - Straight Gloss White 1000mm Height

Size H x W	Watts	BTU	Element Output	Element Type	Code	£ Ex VAT	£ Inc VAT
1000 x 400mm	419	1430	150W	A, D, E or F	89.0114	44.00	52.80
1000 x 500mm	496	1692	300W	A, D, E or F	89.0119	48.00	57.60
1000 x 600mm	573	1955	300W	A, D, E or F	89.0124	51.00	61.20

Wingrave - Straight Gloss White 1200mm Height

Size H x W	Watts	BTU	Element Output	Element Type	Code	£ Ex VAT	£ Inc VAT
1200 x 400mm	514	1754	300W	A, D, E or F	89.0115	51.00	61.20
1200 x 500mm	611	2085	300W	A, D, E or F	89.0120	54.00	64.80
1200 x 600mm	708	2416	300W	A, D, E or F	89.0125	58.00	69.60

WINGRAVE - STRAIGHT, GLOSS WHITE

Wingrave - Straight Gloss White 1400mm Height

Size H x W	Watts	BTU	Element Output	Element Type	Code	£ Ex VAT	£ Inc VAT
1400 x 400mm	571	1948	300W	A, D, E or F	89.0536	60.00	72.00
1400 x 500mm	676	2307	300W	A, D, E or F	89.0537	64.00	76.80
1400 x 600mm	780	2661	300W	A, D, E or F	89.0538	70.00	84.00

Wingrave - Straight Gloss White 1600mm Height

Size H x W	Watts	BTU	Element Output	Element Type	Code	£ Ex VAT	£ Inc VAT
1600 x 400mm	669	2283	300W	A, D, E or F	89.0116	62.00	74.40
1600 x 500mm	794	2709	300W	A, D, E or F	89.0121	68.00	81.60
1600 x 600mm	918	3132	600W	A, D, E or F	89.0126	73.00	87.60

Wingrave - Straight Gloss White 1800mm Height

Size H x W	Watts	BTU	Element Output	Element Type	Code	£ Ex VAT	£ Inc VAT
1800 x 400mm	764	2607	300W	A, D, E or F	89.0117	70.00	84.00
1800 x 500mm	908	3098	600W	A, D, E or F	89.0122	80.00	96.00
1800 x 600mm	1051	3586	600W	A, D, E or F	89.0127	81.00	97.20

D Shape Vent Caps Page 637



Round Vent Caps Page 637



Multi-Rail Hangers Page 635



Towel Hangers Page 636



TECHNICAL INFORMATION

All measurements in Height by Width. Heat output based on $\Delta T60^{\circ}\text{C}$. Radiators that are electric only are restricted to the heat output of the elements. Element size can be increased to full capacity of rail if using element type D, E or F. For element types see pages 628-629. For matching valves see pages 630-634. For indirect heating systems only. Tappings are approx. 44mm less than the width of the rail and approx. 65mm off the wall. Price includes radiator and wall fixing sets, valves extra.



Multirail Range

WINGRAVE - STRAIGHT, MATT WHITE

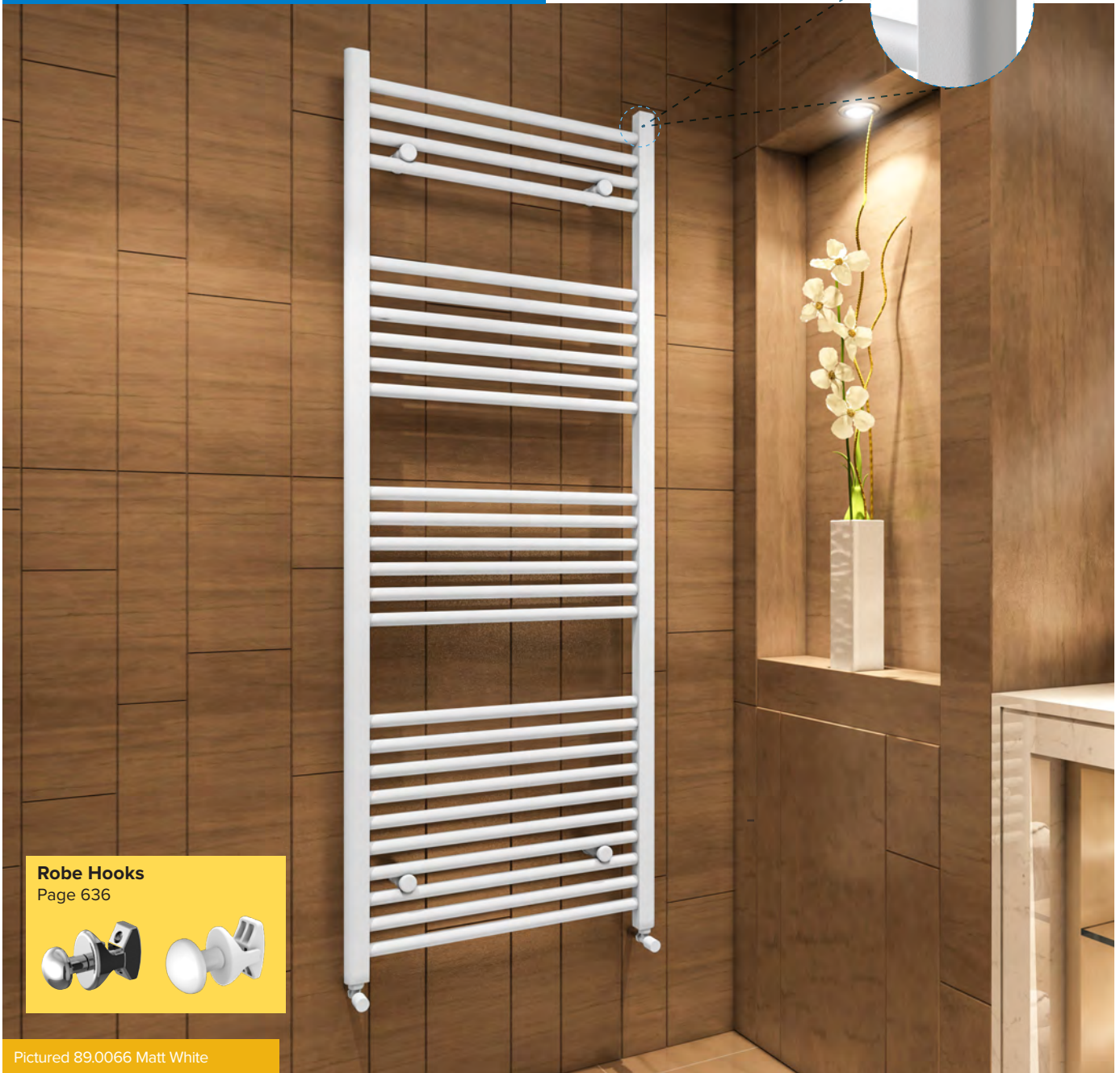

Pictured 89.0066 Matt White

1000mm High

A contemporary straight towel radiator range which comes in chrome, matt anthracite, gloss white and matt white finishes. In a wide variety of sizes this range not only adds to your bathroom with design simplicity but also keeps your towels warm.

FEATURES

- 22mm diameter horizontal round tubes.
- Manufactured and tested to EN442 standard
- CE and NF certificates
- 5 Year manufacturer's warranty*
- Can be single or dual fuel, or all electric

* With conditions

<p>Warranty</p> <p>5</p> <p>Year</p>	<p>Diameter (Ø)</p> <p>22</p> <p>MM Bars</p>	<p>Heating</p>	<p>All Electric</p>	<p>Dual-Fuel</p>
---	---	----------------	---------------------	------------------

800mm High



Multirail Range

Wingrave - Straight Matt White 800mm Height

Size H x W	Watts	BTU	Element Output	Element Type	Code	£ Ex VAT	£ Inc VAT
800 x 400mm	374	1276	150W	A, D, E or F	89.0053	42.00	50.40
800 x 500mm	445	1518	300W	A, D, E or F	89.0058	46.00	55.20
800 x 600mm	517	1764	300W	A, D, E or F	89.0063	48.00	57.60

Wingrave - Straight Matt White 1000mm Height

Size H x W	Watts	BTU	Element Output	Element Type	Code	£ Ex VAT	£ Inc VAT
1000 x 400mm	419	1430	150W	A, D, E or F	89.0054	48.00	57.60
1000 x 500mm	496	1692	300W	A, D, E or F	89.0059	52.00	62.40
1000 x 600mm	573	1955	300W	A, D, E or F	89.0064	56.00	67.20

Wingrave - Straight Matt White 1200mm Height

Size H x W	Watts	BTU	Element Output	Element Type	Code	£ Ex VAT	£ Inc VAT
1200 x 400mm	514	1754	300W	A, D, E or F	89.0055	56.00	67.20
1200 x 500mm	611	2085	300W	A, D, E or F	89.0060	59.00	70.80
1200 x 600mm	708	2416	300W	A, D, E or F	89.0065	63.00	75.60

WINGRAVE - STRAIGHT, MATT WHITE

Wingrave - Straight Matt White 1400mm Height

Size H x W	Watts	BTU	Element Output	Element Type	Code	£ Ex VAT	£ Inc VAT
1400 x 400mm	571	1948	300W	A, D, E or F	89.0539	63.00	75.60
1400 x 500mm	676	2307	300W	A, D, E or F	89.0540	68.00	81.60
1400 x 600mm	780	2661	300W	A, D, E or F	89.0541	73.00	87.60

Wingrave - Straight Matt White 1600mm Height

Size H x W	Watts	BTU	Element Output	Element Type	Code	£ Ex VAT	£ Inc VAT
1600 x 400mm	669	2283	300W	A, D, E or F	89.0056	69.00	82.80
1600 x 500mm	794	2709	300W	A, D, E or F	89.0061	74.00	88.80
1600 x 600mm	918	3132	600W	A, D, E or F	89.0066	78.00	93.60

Wingrave - Straight Matt White 1800mm Height

Size H x W	Watts	BTU	Element Output	Code	£ Ex VAT	£ Inc VAT	
1800 x 400mm	764	2607	300W	A, D, E or F	89.0057	75.00	90.00
1800 x 500mm	908	3098	600W	A, D, E or F	89.0062	89.00	106.80
1800 x 600mm	1051	3586	600W	A, D, E or F	89.0067	90.00	108.00

D Shape Vent Caps

Page 637



Round Vent Caps

Page 637



Multi-Rail Hangers

Page 635



Towel Hangers

Page 636



TECHNICAL INFORMATION

All measurements in Height by Width. Heat output based on $\Delta T60^{\circ}\text{C}$. Radiators that are electric only are restricted to the heat output of the elements. Element size can be increased to full capacity of rail if using element type D, E or F. For element types see pages 628-629. For matching valves see pages 630-634. For indirect heating systems only. Tappings are approx. 44mm less than the width of the rail and approx. 65mm off the wall. Price includes radiator and wall fixing sets, valves extra.

1200mm High



1400mm High



1600mm High



1800mm High



Multirail Range

WINGRAVE - CURVED CHROME





Pictured 89.0392 Chrome

A high quality contemporary range available in a curved design and chrome finish. Available with robe hook accessories. This range is the ultimate in simplicity of style and practicality for your bathroom, keeping your towels warm.

FEATURES

- 22mm diameter horizontal round tubes.
 - Manufactured and tested to EN442 standard
 - CE and NF certificates
 - 5 Year manufacturer's warranty*
 - Can be single or dual fuel, or all electric
- * With conditions

<p>Warranty</p> <p>5</p> <p>Year</p>	<p>Diameter (Ø)</p> <p>22</p> <p>MM Bars</p>	<p>Heating</p> 	<p>All Electric</p> 	<p>Dual-Fuel</p> 
---	---	--	---	--

Multirail Range

WINGRAVE - CURVED CHROME

Wingrave - Curved Chrome 800mm Height

Size H x W	Watts	BTU	Element Output	Element Type	Code	£ Ex VAT	£ Inc VAT
800 x 400mm	250	854	150W	A, D, E or F	89.0384	62.00	74.40
800 x 500mm	288	1017	150W	A, D, E or F	89.0385	71.00	85.20
800 x 600mm	346	1180	150W	A, D, E or F	89.0386	77.00	92.40

Wingrave - Curved Chrome 1000mm Height

Size H x W	Watts	BTU	Element Output	Element Type	Code	£ Ex VAT	£ Inc VAT
1000 x 400mm	289	987	150W	A, D, E or F	89.0387	74.00	88.80
1000 x 500mm	342	1168	150W	A, D, E or F	89.0388	82.00	98.40
1000 x 600mm	396	1350	150W	A, D, E or F	89.0389	91.00	109.20

Wingrave - Curved Chrome 1200mm Height

Size H x W	Watts	BTU	Element Output	Element Type	Code	£ Ex VAT	£ Inc VAT
1200 x 400mm	355	1211	150W	A, D, E or F	89.0390	87.00	104.40
1200 x 500mm	422	1438	150W	A, D, E or F	89.0391	97.00	116.40
1200 x 600mm	488	1696	300W	A, D, E or F	89.0392	107.00	128.40

Wingrave - Curved Chrome 1400mm Height

Size H x W	Watts	BTU	Element Output	Element Type	Code	£ Ex VAT	£ Inc VAT
1400 x 400mm	465	1586	150W	A, D, E or F	89.0393	115.00	138.00
1400 x 500mm	552	1880	300W	A, D, E or F	89.0394	126.00	151.20
1400 x 600mm	638	2176	300W	A, D, E or F	89.0395	137.00	164.40

Wingrave - Curved Chrome 1600mm Height

Size H x W	Watts	BTU	Element Output	Element Type	Code	£ Ex VAT	£ Inc VAT
1600 x 400mm	530	1810	300W	A, D, E or F	89.0396	129.00	154.80
1600 x 500mm	630	2151	300W	A, D, E or F	89.0397	142.00	170.40
1600 x 600mm	730	2492	300W	A, D, E or F	89.0398	153.00	183.60

D Shape Vent Caps

Page 637



Round Vent Caps

Page 637



Robe Hooks

Page 636

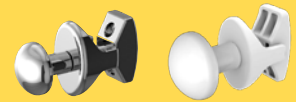

TECHNICAL INFORMATION

All measurements in Height by Width. Heat output based on $\Delta T60^{\circ}\text{C}$. Radiators that are electric only are restricted to the heat output of the elements. Element size can be increased to full capacity of rail if using element type D, E or F. For element types see pages 628-629. For matching valves see pages 630-634. For indirect heating systems only. Tappings are approx. 44mm less than the width of the rail and approx. 65mm off the wall. Price includes radiator and wall fixing sets, valves extra.

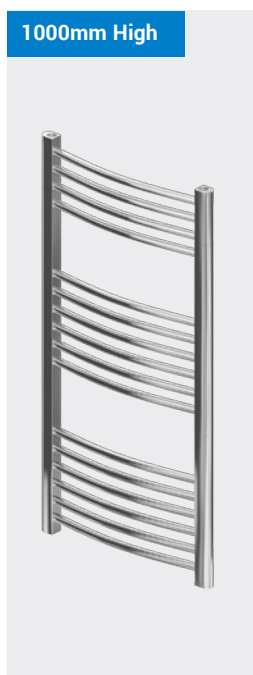

Multirail Range

BIAVA MULTIRAIL - STRAIGHT WHITE



Pictured 41.0278 White

A high quality contemporary range available in straight and curved designs, and white or chrome finishes. Available with towel hangers or robe hook accessories. This range is the ultimate in simplicity of style and practicality for your bathroom, keeping your towels warm.

Biava Multirail - Straight White

Size H x W	Watts	BTU	Element Output	Element Type	Code	£ Ex VAT	£ Inc VAT
360 x 400mm	145	495	100W	A, D, E or F	41.0278	34.00	40.80
688 x 450mm	344	1174	150W	A, D, E or F	41.0279	65.00	78.00
688 x 600mm	438	1494	150W	A, D, E or F	41.0280	67.00	80.40
688 x 750mm	532	1815	300W	A, D, E or F	41.0281	69.00	82.80
1118 x 450mm	546	1863	300W	A, D, E or F	41.0282	78.00	93.60
1118 x 600mm	695	2371	300W	A, D, E or F	41.0283	81.00	97.20
1118 x 750mm	843	2876	300W	A, D, E or F	41.0284	88.00	105.60
1720 x 450mm	843	2876	300W	A, D, E or F	41.0285	110.00	132.00
1720 x 600mm	1072	3658	600W	A, D, E or F	41.0286	116.00	139.20
1720 x 750mm	1302	4442	600W	A, D, E or F	41.0287	124.00	148.80

FEATURES

- 22mm diameter horizontal round tubes.
- Manufactured and tested to EN442 standard
- CE and NF certificates
- 5 Year manufacturer's warranty*
- Can be single or dual fuel, or all electric
- * With conditions

TECHNICAL INFORMATION

All measurements in Height by Width. Heat output based on $\Delta T60^{\circ}\text{C}$. Radiators that are electric only are restricted to the heat output of the elements. Element size can be increased to full capacity of rail if using element type D, E or F. For element types see pages 628-629. For matching valves see pages 630-634. For indirect heating systems only. Tappings are approx. 50mm less than the width of the rail and approx. 75mm off the wall. Price includes radiator and wall fixing sets, valves extra.

Warranty

5

Year

Diameter (Ø)

22

MM Bars

Heating

All Electric

Dual-Fuel



Round Vent Caps
Page 637

Towel Hangers
Page 636

Robe Hooks
Page 636

Multi-Rail Hangers
Page 635

Multirail Range

BIAVA MULTIRAIL - STRAIGHT CHROME



Pictured 41.0272 Chrome

A high quality contemporary range available in straight and curved designs, and white or chrome finishes. Available with towel hangers or robe hook accessories. This range is the ultimate in simplicity of style and practicality for your bathroom, keeping your towels warm.

FEATURES

- 22mm diameter horizontal round tubes.
 - Manufactured and tested to EN442 standard
 - CE and NF certificates
 - 5 Year Manufacturer's Warranty*
 - Can be single, dual fuel, or all electric
- * With conditions

TECHNICAL INFORMATION

All measurements in Height by Width. Heat output based on $\Delta T60^{\circ}\text{C}$. Radiators that are electric only are restricted to the heat output of the elements. Element size can be increased to full capacity of rail if using element type D, E or F. For element types see pages 628-629. For matching valves see pages 630-634. For indirect heating systems only. Tappings are approx. 50mm less than the width of the rail and approx. 75mm off the wall. Price includes radiator and wall fixing sets, valves extra.

Biava Multirail - Straight Chrome								
Size H x W	Watts	BTU	Element Output	Element Type	Code	£ Ex VAT	£ Inc VAT	
360x400mm	113	386	100W	A, D, E or F	41.0268	58.00	69.60	
688x450mm	270	921	150W	A, D, E or F	41.0269	123.00	147.60	
688x600mm	344	1174	150W	A, D, E or F	41.0270	137.00	164.40	
688x750mm	418	1426	150W	A, D, E or F	41.0271	153.00	183.60	
1118x450mm	430	1467	150W	A, D, E or F	41.0272	154.00	184.80	
1118x600mm	546	1863	300W	A, D, E or F	41.0273	167.00	200.40	
1118x750mm	663	2262	300W	A, D, E or F	41.0274	182.00	218.40	
1720x450mm	663	2262	300W	A, D, E or F	41.0275	214.00	256.80	
1720x600mm	843	2876	300W	A, D, E or F	41.0276	222.00	266.40	
1720x750mm	1024	3494	600W	A, D, E or F	41.0277	242.00	290.40	

Round Vent Caps

Page 637

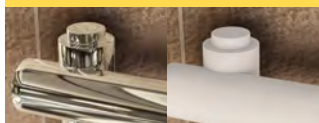

Robe Hooks

Page 636



Towel Hangers

Page 636



Multi-Rail Hangers

Page 635



Warranty
5
Year

Diameter (Ø)
22
MM Bars

Heating

All Electric

Dual-Fuel

Multirail Range

BIAVA MULTIRAIL - CURVED WHITE

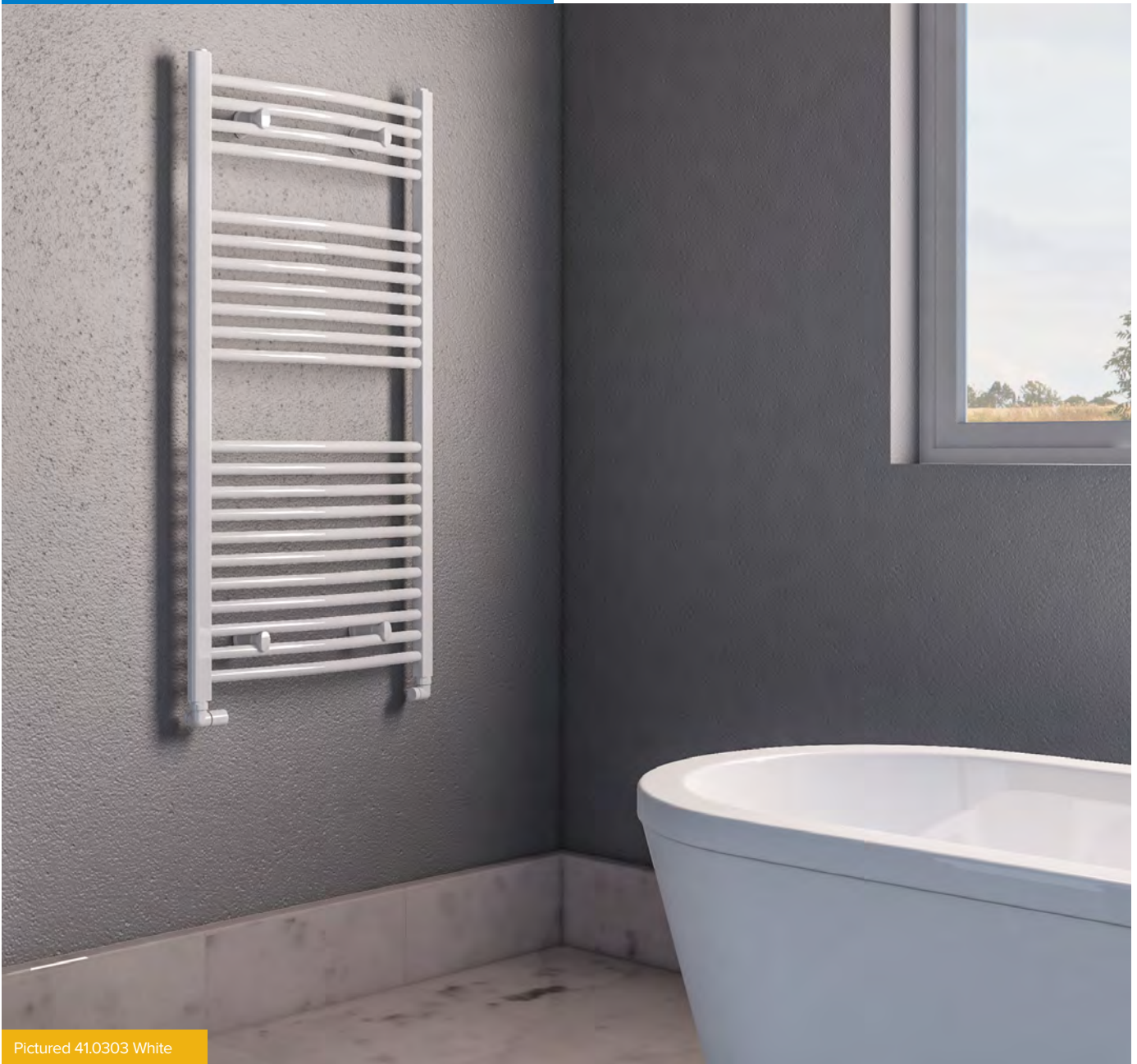

Pictured 41.0303 White

FEATURES

- 22mm diameter horizontal round tubes.
 - Manufactured and tested to EN442 standard
 - CE and NF certificates
 - 5 Year Manufacturer's Warranty*
 - Can be single, dual fuel, or all electric
- * With conditions

TECHNICAL INFORMATION

All measurements in Height by Width. Heat output based on $\Delta T60^{\circ}\text{C}$. Radiators that are electric only are restricted to the heat output of the elements. Element size can be increased to full capacity of rail if using element type D, E or F. For element types see pages 628-629. For matching valves see pages 630-634. For indirect heating systems only. Tappings are approx. 50mm less than the width of the rail and approx. 75mm off the wall. Price includes radiator and wall fixing sets, valves extra.

Biava Multirail - Curved White

Size H x W	Watts	BTU	Element Output	Element Type	Code	£ Ex VAT	£ Inc VAT
360x400mm	145	495	100W	A, D, E or F	41.0298	35.00	42.00
688x450mm	347	1184	150W	A, D, E or F	5.401	74.00	88.80
688x600mm	440	1501	150W	A, D, E or F	41.0300	76.00	91.20
688x750mm	535	1825	300W	A, D, E or F	41.0301	77.00	92.40
1118x450mm	550	1877	300W	A, D, E or F	41.0302	86.00	103.20
1118x600mm	699	2385	300W	A, D, E or F	41.0303	88.00	105.60
1118x750mm	846	2887	300W	A, D, E or F	41.0304	96.00	115.20
1720x450mm	849	2897	300W	A, D, E or F	41.0305	124.00	148.80
1720x600mm	1078	3678	600W	A, D, E or F	41.0306	128.00	153.60
1720x750mm	1307	4459	600W	A, D, E or F	41.0307	136.00	163.20

Warranty

5

Year

Diameter (Ø)

22

MM Bars

Heating



All Electric



Dual-Fuel



Round Vent Caps

Page 637



Robe Hooks

Page 636



Multirail Range

BIAVA MULTIRAIL - CURVED CHROME

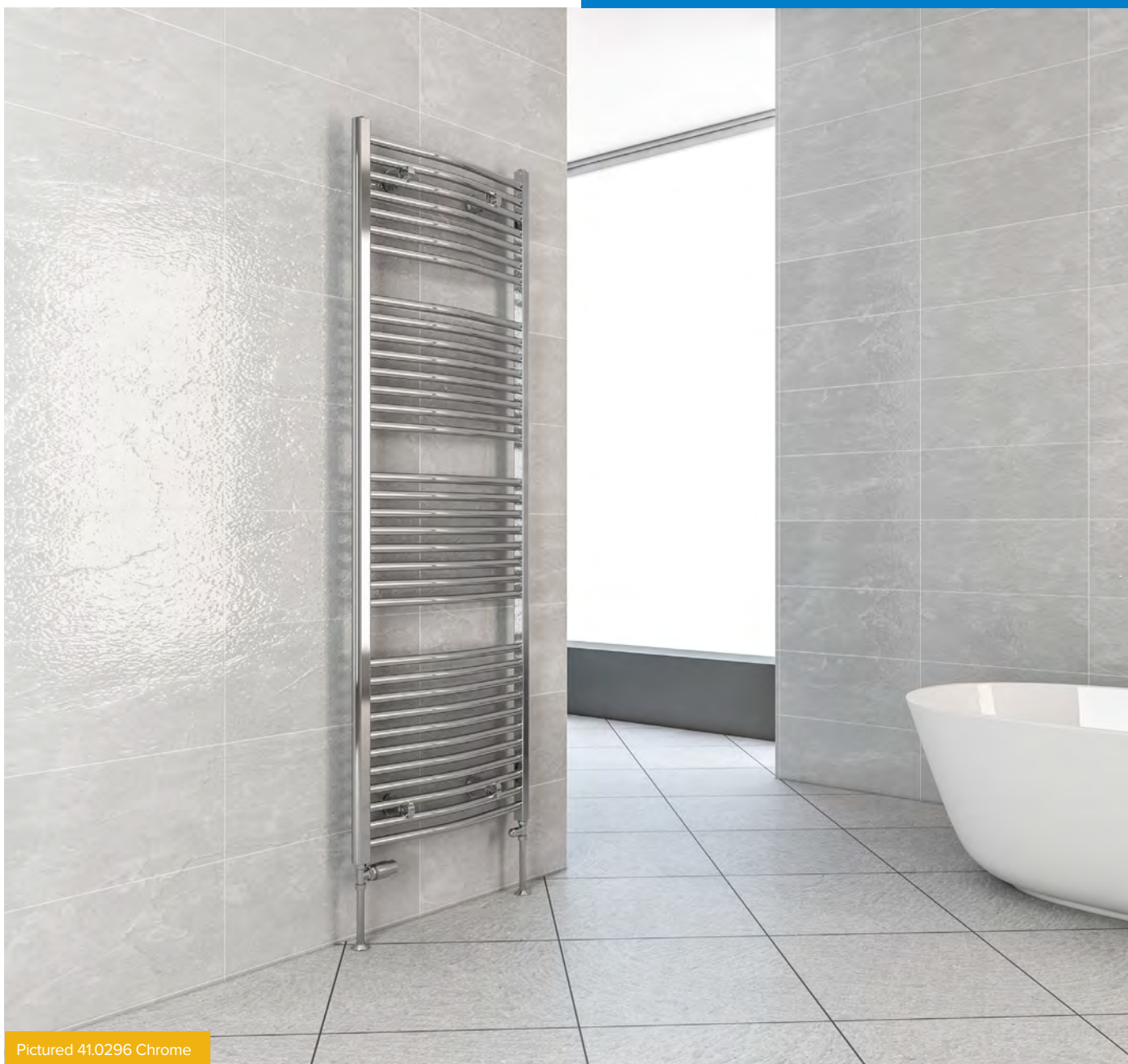

Pictured 41.0296 Chrome

FEATURES

- 22mm diameter horizontal round tubes.
 - Manufactured and tested to EN442 standard
 - CE and NF certificates
 - 5 Year Manufacturer's Warranty*
 - Can be single, dual fuel, or all electric
- * With conditions

TECHNICAL INFORMATION

All measurements in Height by Width. Heat output based on ▲T60°C. Radiators that are electric only are restricted to the heat output of the elements. Element size can be increased to full capacity of rail if using element type D, E or F. For element types see pages 628-629. For matching valves see pages 630-634. For indirect heating systems only. Tappings are approx. 50mm less than the width of the rail and approx. 75mm off the wall. Price includes radiator and wall fixing sets, valves extra.

Biava Multirail - Curved Chrome

Size H x W	Watts	BTU	Element Output	Element Type	Code	£ Ex VAT	£ Inc VAT
360x400mm	114	389	100W	A, D, E or F	41.0288	55.00	66.00
688x450mm	273	931	150W	A, D, E or F	41.0289	135.00	162.00
688x600mm	347	1184	150W	A, D, E or F	41.0290	152.00	182.40
688x750mm	421	1436	150W	A, D, E or F	41.0291	167.00	200.40
1118x450mm	433	1477	150W	A, D, E or F	41.0292	168.00	201.60
1118x600mm	549	1873	300W	A, D, E or F	41.0293	184.00	220.80
1118x750mm	666	2272	300W	A, D, E or F	41.0294	201.00	241.20
1720x450mm	668	2279	300W	A, D, E or F	41.0295	241.00	289.20
1720x600mm	848	2893	300W	A, D, E or F	41.0296	245.00	294.00
1720x750mm	1029	3511	600W	A, D, E or F	41.0297	265.00	318.00

Warranty

5
Year

Diameter (Ø)

22
MM Bars

Heating

All Electric

Dual-Fuel

Round Vent Caps

Page 637

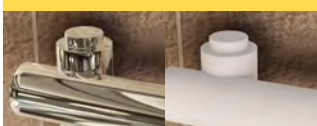

Robe Hooks

Page 636

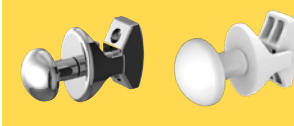

Multirail Range

BIAVA DRY ELEMENT - STRAIGHT



Pictured 47.0001 Chrome

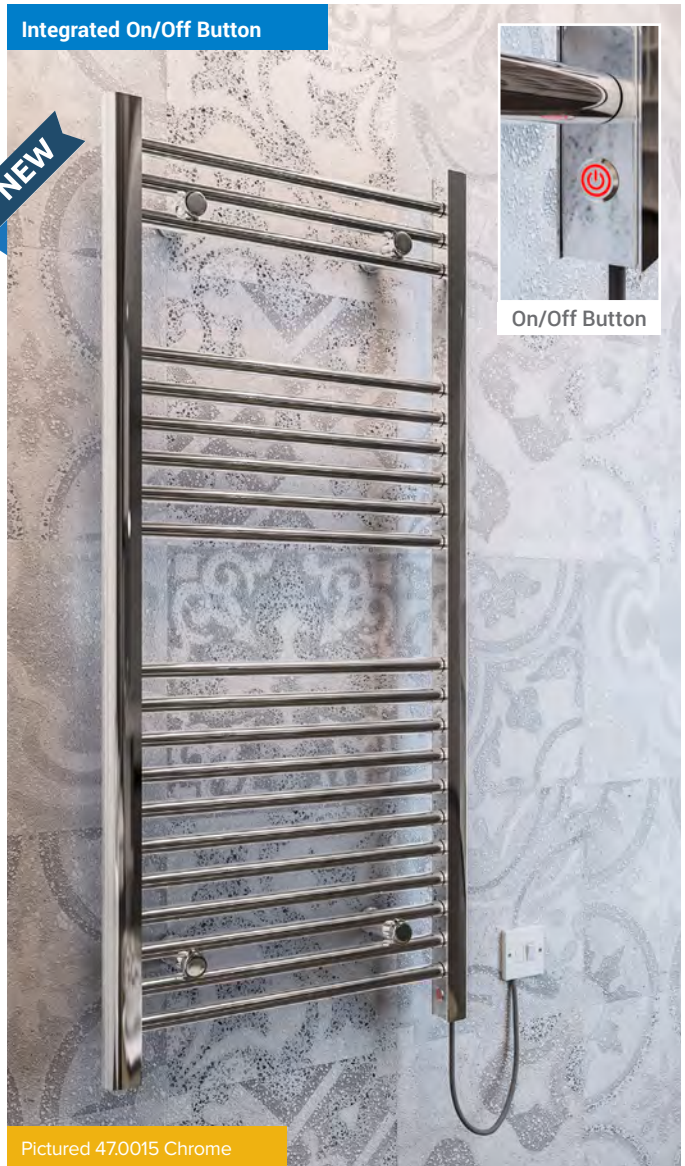

Pictured 47.0015 Chrome

Biava Dry Element Towel Rail - Chrome [Integrated On/Off Button]

Size H x W	Watts	BTU	Code	£ Ex VAT	£ Inc VAT
1100 x 500mm	400	1365	47.0015	194.00	232.80

Biava Dry Element Towel Rail - Chrome

Size H x W	Watts	BTU	Code	£ Ex VAT	£ Inc VAT
700 x 500mm	250	853	47.0001	131.00	157.20
700 x 600mm	300	1024	47.0003	143.00	171.60
1100 x 500mm	400	1365	47.0002	174.00	208.80
1100 x 600mm	500	1706	47.0004	199.00	238.80

Biava Dry Element Towel Rail - White

Size H x W	Watts	BTU	Code	£ Ex VAT	£ Inc VAT
700 x 500mm	250	853	47.0005	99.00	118.80
700 x 600mm	300	1024	47.0007	112.00	134.40
1100 x 500mm	400	1365	47.0006	135.00	162.00
1100 x 600mm	500	1706	47.0008	155.00	186.00

Biava Dry Element Towel Rail - Matt Anthracite

Size H x W	Watts	BTU	Code	£ Ex VAT	£ Inc VAT
700 x 500mm	250	853	47.0009	110.00	132.00
700 x 600mm	300	1024	47.0011	124.00	148.80
1100 x 500mm	400	1365	47.0010	147.00	176.40
1100 x 600mm	500	1706	47.0012	170.00	204.00

FEATURES

- 19mm diameter horizontal round tubes
 - No fluid filling required
 - Just Connect and Go
 - IPX4 Certificates
 - Compatible with the Crafton Temperature Control Plate
 - 2 Year Manufacturer's Warranty*
- * With conditions

These products are electric only installation and cannot be used on a central heating system.

TECHNICAL INFORMATION

All measurements in Height by Width. Heat output based on ▲T60°C. This rail is reversible. Can not be fitted upside down.

Warranty

2

Year

Diameter (∅)

19

MM Bars

All Electric

Multirail Range

BIAVA DRY ELEMENT - STRAIGHT



White

Pictured 47.0007 White



Chrome

Pictured 47.0004 Chrome



Matt Anthracite

Pictured 47.0012 Matt Anthracite



Pictured 67.0004

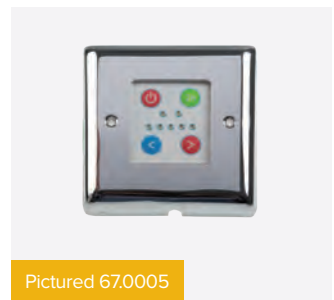

Pictured 67.0005

Optional Extra - Crafton Temperature Control Panel

Description	Code	£ Ex VAT	£ Inc VAT
Crafton Temperature Control Panel	67.0004	74.00	88.80
Chrome Plate for Crafton Temp Panel	67.0005	24.00	28.80

This item is an additional extra, that can be used with all above colours of the Biava Dry Element Towel Rails. Please see page 629 for more product details.

Robe Hooks Page 636

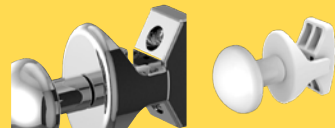

Towel Hangers Page 636



Multi-Rail Hangers Page 635



Multirail Range

BIAVA HIGH OUTPUT - STRAIGHT CHROME

High Output



20% OFF



Pictured 43.0006 Chrome

An addition to the Biava range, this straight multirail boasts a higher output for the larger bathrooms. It contains more tubes per radiator than the standard Biava and each tube is 23mm diameter compared to standard 22mm. Producing a higher heat output in less space.

FEATURES

- 23mm diameter horizontal round tubes.
 - Manufactured and tested to EN442 standard
 - CE and NF certificates
 - 5 Year manufacturer's warranty*
 - Can be single or dual fuel, or all electric
- * With conditions

<p>Warranty</p> <p>5</p> <p>Year</p>	<p>Diameter (Ø)</p> <p>23</p> <p>MM Bars</p>	<p>Heating</p>	<p>All Electric</p>	<p>Dual-Fuel</p>
---	---	----------------	---------------------	------------------

Biava High Output - Straight Chrome						WAS	NOW JUST	
Size H x W	Watts	BTU	Element Output	Element Type	Code	£ Ex VAT	£ Ex VAT	£ Inc VAT
600 x 400mm	189	630	100W	A, D, E or F	43.0001†	90.00	72.00	86.40
600 x 500mm	227	757	100W	A, D, E or F	43.0002	100.00	80.00	96.00
600 x 600mm	265	884	100W	A, D, E or F	43.0003	112.00	90.00	108.00
1200 x 400mm	385	1285	150W	A, D, E or F	43.0004	137.00	110.00	132.00
1200 x 500mm	465	1552	150W	A, D, E or F	43.0005	146.00	117.00	140.40
1200 x 600mm	545	1822	300W	A, D, E or F	43.0006	157.00	126.00	151.20
1800 x 500mm	651	2174	300W	A, D, E or F	43.0007	259.00	208.00	249.60



TECHNICAL INFORMATION

All measurements in Height by Width. Heat output based on ▲T60°C. Radiators that are electric only are restricted to the heat output of the elements. Element size can be increased to full capacity of rail if using element type D, E or F. For element types see pages 628-629. For matching valves see pages 630-634. For indirect heating systems only. Tappings are approx. 40mm less than the width of the rail and approx. 63mm off the wall. Price includes radiator and wall fixing sets, valves extra.

Round Vent Caps
Page 637

Robe Hooks
Page 636

Towel Hangers
Page 636

Multi-Rail Hangers
Page 635

Multirail Range

BIAVA ROUND



Pictured 41.0152 Chrome

A high quality modern, straight towel rail with a durable shiny chrome finish and round rails. A functional radiator with spacing to allow the warming of many towels yet with style that is aesthetically pleasing and will fit into any bathroom.

Biava Round - White							
Size H x W	Watts	BTU	Element Output	Element Type	Code	£ Ex VAT	£ Inc VAT
600 x 400mm	218	744	100W	A, D or E	41.0154	53.00	63.60
600 x 500mm	257	877	150W	A, D or E	41.0157	55.00	66.00
600 x 600mm	296	1010	150W	A, D or E	41.0160	58.00	69.60
1200 x 400mm	412	1406	150W	A, D or E	41.0155	80.00	96.00
1200 x 500mm	482	1645	150W	A, D or E	41.0158	87.00	104.40
1200 x 600mm	552	1883	300W	A, D or E	41.0161	92.00	110.40
1800 x 400mm	618	2109	300W	A, D or E	41.0156	110.00	132.00
1800 x 500mm	723	2467	300W	A, D or E	41.0159	119.00	142.80
1800 x 600mm	827	2822	300W	A, D or E	41.0162	128.00	153.60

FEATURES

- 19mm diameter horizontal round tubes.
- Manufactured and tested to EN442 standard
- CE and NF certificates
- 5 Year manufacturer's warranty*
- Can be single or dual fuel, or all electric
- * With conditions

Warranty

5

Year

Diameter (Ø)

19

MM Bars

Heating

All Electric

Dual-Fuel

Round Vent Caps
Page 637

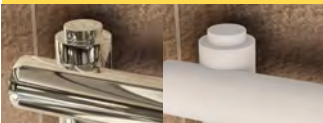

Towel Hangers
Page 636



Robe Hooks
Page 636

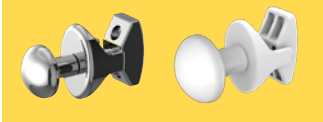

Biava Round - Chrome							
Size H x W	Watts	BTU	Element Output	Element Type	Code	£ Ex VAT	£ Inc VAT
600 x 400mm	172	587	100W	A, D or E	41.0145	91.00	109.20
600 x 500mm	202	689	100W	A, D or E	41.0148	95.00	114.00
600 x 600mm	234	798	150W	A, D or E	41.0151	101.00	121.20
1200 x 400mm	324	1105	150W	A, D or E	41.0146	146.00	175.20
1200 x 500mm	379	1293	150W	A, D or E	41.0149	157.00	188.40
1200 x 600mm	435	1484	150W	A, D or E	41.0152	168.00	201.60
1800 x 400mm	486	1658	300W	A, D or E	41.0147	205.00	246.00
1800 x 500mm	569	1941	300W	A, D or E	41.0150	222.00	266.40
1800 x 600mm	651	2221	300W	A, D or E	41.0153	249.00	298.80

TECHNICAL INFORMATION

All measurements in Height by Width. Heat output based on ▲T60°C. Radiators that are electric only are restricted to the heat output of the elements. Element size can be increased to full capacity of rail if using element type D or E. For element types see pages 628-629. For matching valves see pages 630-634. For indirect heating systems only. Tappings are approx. 40mm less than the width of the rail and approx. 63mm off the wall. Price includes radiator and wall fixing sets, valves extra.

Multirail Range

WESTWARD - STRAIGHT

High Output 



Pictured 89.0591 Chrome

Warranty
5
Year

D Shape Vent Caps
Page 637



Round Vent Caps
Page 637



Towel Hangers
Page 636



Robe Hooks
Page 636



Multi-Rail Hangers
Page 635



In addition to the Wingrave & Wendover ranges, this straight multirail boasts a higher output for the larger bathrooms. Each horizontal tube is 25mm diameter compared to standard 22mm producing a higher heat output in less space.

FEATURES

- 25mm diameter horizontal round tubes.
- Manufactured and tested to EN442 standard
- CE and NF certificates
- 5 Year manufacturer's warranty*
- Can be single or dual fuel, or all electric

* With conditions

Diameter (Ø)
25
MM Bars

Heating

All Electric

Dual-Fuel

Multirail Range

WESTWARD - STRAIGHT

Westward - Straight Gloss White 600mm Height							
Size H x W	Watts	BTU	Element Output	Element Type	Code	£ Ex VAT	£ Inc VAT
600 x 500mm	371	1266	150W	A, D, E or F	89.0572	46.00	55.20
600 x 600mm	434	1481	150W	A, D, E or F	89.0573	49.00	58.80
600 x 800mm	560	1911	300W	A, D, E or F	89.0574	59.00	70.80

Westward - Straight Gloss White 800mm Height							
Size H x W	Watts	BTU	Element Output	Element Type	Code	£ Ex VAT	£ Inc VAT
800 x 400mm	399	1361	150W	A, D, E or F	89.0575	45.00	54.00
800 x 500mm	479	1634	300W	A, D, E or F	89.0576	49.00	58.80
800 x 600mm	599	1907	300W	A, D, E or F	89.0577	51.00	61.20

Westward - Straight Gloss White 1200mm Height							
Size H x W	Watts	BTU	Element Output	Element Type	Code	£ Ex VAT	£ Inc VAT
1200 x 400mm	550	1877	300W	A, D, E or F	89.0578	59.00	70.80
1200 x 500mm	660	2252	300W	A, D, E or F	89.0579	63.00	75.60
1200 x 600mm	768	2621	300W	A, D, E or F	89.0580	68.00	81.60

Westward - Straight Gloss White 1800mm Height							
Size H x W	Watts	BTU	Element Output	Element Type	Code	£ Ex VAT	£ Inc VAT
1800 x 400mm	816	2784	300W	A, D, E or F	89.0581	82.00	98.40
1800 x 500mm	978	3337	600W	A, D, E or F	89.0582	95.00	114.00
1800 x 600mm	1140	3890	600W	A, D, E or F	89.0583	96.00	115.20

Westward - Straight Chrome 600mm Height							
Size H x W	Watts	BTU	Element Output	Element Type	Code	£ Ex VAT	£ Inc VAT
600 x 500mm	245	836	150W	A, D, E or F	89.0584	72.00	86.40
600 x 600mm	287	979	150W	A, D, E or F	89.0585	80.00	96.00
600 x 800mm	371	1266	150W	A, D, E or F	89.0586	96.00	115.20

Westward - Straight Chrome 800mm Height							
Size H x W	Watts	BTU	Element Output	Element Type	Code	£ Ex VAT	£ Inc VAT
800 x 400mm	263	897	150W	A, D, E or F	89.0587	68.00	81.60
800 x 500mm	316	1078	150W	A, D, E or F	89.0588	76.00	91.20
800 x 600mm	370	1262	150W	A, D, E or F	89.0589	84.00	100.80

Westward - Straight Chrome 1200mm Height							
Size H x W	Watts	BTU	Element Output	Element Type	Code	£ Ex VAT	£ Inc VAT
1200 x 400mm	375	1280	150W	A, D, E or F	89.0590	94.00	112.80
1200 x 500mm	450	1535	300W	A, D, E or F	89.0591	105.00	126.00
1200 x 600mm	524	1788	300W	A, D, E or F	89.0592	116.00	139.20

Westward - Straight Chrome 1800mm Height							
Size H x W	Watts	BTU	Element Output	Element Type	Code	£ Ex VAT	£ Inc VAT
1800 x 400mm	564	1924	300W	A, D, E or F	89.0593	140.00	168.00
1800 x 500mm	677	2310	300W	A, D, E or F	89.0594	154.00	184.80
1800 x 600mm	788	2689	300W	A, D, E or F	89.0595	166.00	199.20

TECHNICAL INFORMATION

All measurements in Height by Width. Heat output based on $\Delta T60^{\circ}\text{C}$. Radiators that are electric only are restricted to the heat output of the elements. Element size can be increased to full capacity of rail if using element type D, E or F. For element types see pages 628-629. For matching valves see pages 630-634. For indirect heating systems only. Tappings are approx. 44mm less than the width of the rail and approx. 65mm off the wall. Price includes radiator and wall fixing sets, valves extra.



Multirail Range

BIAVA - TUBE ON TUBE



Pictured 41.0171 Chrome

A contemporary tubular design towel rail in a range of sizes and both chrome and white finishes. The tube on tube features produces a higher heat output.

Biava - Tube on Tube - White							
Size H x W	Watts	BTU	Element Output	Element Type	Code	£ Ex VAT	£ Inc VAT
600 x 400mm	233	795	150W	A, D or E	41.0172	58.00	69.60
600 x 500mm	272	928	150W	A, D or E	41.0175	61.00	73.20
600 x 600mm	312	1065	150W	A, D or E	41.0178	65.00	78.00
1200 x 400mm	545	1860	300W	A, D or E	41.0173	101.00	121.20
1200 x 500mm	642	2191	300W	A, D or E	41.0176	111.00	133.20
1200 x 600mm	738	2518	300W	A, D or E	41.0179	117.00	140.40
1800 x 400mm	840	2866	300W	A, D or E	41.0174	142.00	170.40
1800 x 500mm	991	3381	600W	A, D or E	41.0177	155.00	186.00
1800 x 600mm	1143	3900	600W	A, D or E	41.0180	168.00	201.60

FEATURES

- 19mm diameter horizontal round tubes.
 - Manufactured and tested to EN442 standard
 - CE and NF certificates
 - 5 Year manufacturer's warranty*
 - Can be single or dual fuel, or all electric
- * With conditions

Biava - Tube on Tube - Chrome							
Size H x W	Watts	BTU	Element Output	Element Type	Code	£ Ex VAT	£ Inc VAT
600 x 400mm	183	624	100W	A, D or E	41.0163	101.00	121.20
600 x 500mm	214	730	100W	A, D or E	41.0166	107.00	128.40
600 x 600mm	245	836	150W	A, D or E	41.0169	113.00	135.60
1200 x 400mm	428	1460	150W	A, D or E	41.0164	188.00	225.60
1200 x 500mm	505	1723	300W	A, D or E	41.0167	205.00	246.00
1200 x 600mm	580	1979	300W	A, D or E	41.0170	220.00	264.00
1800 x 400mm	661	2255	300W	A, D or E	41.0165	275.00	330.00
1800 x 500mm	780	2661	600W	A, D or E	41.0168	299.00	358.80
1800 x 600mm	898	3064	600W	A, D or E	41.0171	324.00	388.80

TECHNICAL INFORMATION

All measurements in Height by Width. Heat output based on $\Delta T60^{\circ}C$. Radiators that are electric only are restricted to the heat output of the elements. Element size can be increased to full capacity of rail if using element type D or E. For element types see pages 628-629. For matching valves see pages 630-634. For indirect heating systems only. Tappings are approx. 50mm less than the width of the rail and approx. 55mm off the wall. Price includes radiator and wall fixing sets, valves extra.

Round Vent Caps

Page 637



Towel Hangers

Page 636



Robe Hooks

Page 636

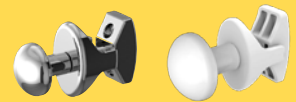

Multi-Rail Hangers

Page 635



Warranty

5

Year

Diameter (Ø)

19

MM Bars

Heating

All Electric

Dual-Fuel

Multirail Range

BIAVA - DOUBLE TUBE ON TUBE

High Output 

20% OFF



Pictured 43.0014 Chrome

The double set of rails allow for an alternative design to your standard bathroom towel warmer. A towel rail which keeps your towels warm as well as your whole bathroom.

FEATURES

- 23mm diameter double set horizontal round tubes.
 - Manufactured and tested to EN442 standard
 - CE and NF certificates
 - 5 Year manufacturer's warranty*
 - Can be single or dual fuel, or all electric
- * With conditions

Warranty

5
Year

Diameter (Ø)

23
MM Bars

Heating

All Electric

Dual-Fuel

The Biava Double Tube on Tube has a higher heat output than regular towel rails.



Round Vent Caps
Page 637



Towel Hangers
Page 636



Robe Hooks
Page 636

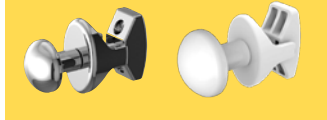

Biava Double Tube on Tube Chrome						WAS	NOW JUST	
Size H x W	Watts	BTU	Element Output	Element Type	Code	£ Ex VAT	£ Ex VAT	£ Inc VAT
600 x 400mm	312	1078	150W	A, D or E	43.0009	223.00	179.00	214.80
600 x 500mm	376	1443	150W	A, D or E	43.0010	259.00	208.00	249.60
600 x 600mm	439	1685	300W	A, D or E	43.0011	288.00	231.00	277.20
1200 x 400mm	623	2392	300W	A, D or E	43.0012	444.00	356.00	427.20
1200 x 500mm	750	2789	600W	A, D or E	43.0013	493.00	395.00	474.00
1200 x 600mm	878	2994	600W	A, D or E	43.0014	543.00	435.00	522.00
1800 x 500mm	1095	4203	600W	A, D or E	43.0015	687.00	550.00	660.00
1800 x 600mm	1280	4913	900W	A, D or E	43.0016	761.00	609.00	730.80

TECHNICAL INFORMATION

All measurements in Height by Width. Heat output based on ΔT60°C. Radiators that are electric only are restricted to the heat output of the elements. Element size can be increased to full capacity of rail if using element type D or E. For element types see pages 628-629. For matching valves see pages 630-634. For indirect heating systems only. Tappings are approx. 40mm less than the width of the rail and approx. 132mm off the wall. Price includes radiator and wall fixing sets, valves extra.

Multirail Range

BIAVA - SQUARE



Pictured 41.0116 Chrome



Round Vent Caps
Page 637



A modern style square rail that still allows maximum space for keeping your towels warm.

Biava - Square Chrome							
Size H x W	Watts	BTU	Element Output	Element Type	Code	£ Ex VAT	£ Inc VAT
600 x 400mm	221	754	100W	A, D or E	41.0109	141.00	169.20
600 x 500mm	260	887	150W	A, D or E	41.0112	154.00	184.80
600 x 600mm	299	1020	150W	A, D or E	41.0115	166.00	199.20
1200 x 400mm	511	1744	300W	A, D or E	41.0110	272.00	326.40
1200 x 500mm	612	2088	300W	A, D or E	41.0113	308.00	369.60
1200 x 600mm	712	2429	300W	A, D or E	41.0116	333.00	399.60
1800 x 400mm	746	2545	300W	A, D or E	41.0111	381.00	457.20
1800 x 500mm	889	3033	300W	A, D or E	41.0114	426.00	511.20
1800 x 600mm	1034	3528	600W	A, D or E	41.0117	470.00	564.00

FEATURES

- Manufactured and tested to EN442 standard
 - CE and NF certificates
 - 5 Year manufacturer's warranty*
 - Can be single or dual fuel, or all electric
- * With conditions

Biava - Square White							
Size H x W	Watts	BTU	Element Output	Element Type	Code	£ Ex VAT	£ Inc VAT
600 x 400mm	280	955	150W	A, D or E	41.0118	83.00	99.60
600 x 500mm	330	1126	150W	A, D or E	41.0121	90.00	108.00
600 x 600mm	381	1300	150W	A, D or E	41.0124	95.00	114.00
1200 x 400mm	650	2218	300W	A, D or E	41.0119	147.00	176.40
1200 x 500mm	777	2651	300W	A, D or E	41.0122	164.00	196.80
1200 x 600mm	906	3091	300W	A, D or E	41.0125	182.00	218.40
1800 x 400mm	949	3238	300W	A, D or E	41.0120	202.00	242.40
1800 x 500mm	1131	3859	600W	A, D or E	41.0123	224.00	268.80
1800 x 600mm	1314	4483	600W	A, D or E	41.0126	248.00	297.60

TECHNICAL INFORMATION

All measurements in Height by Width. Heat output based on $\Delta T60^{\circ}\text{C}$. Radiators that are electric only are restricted to the heat output of the elements. Element size can be increased to full capacity of rail if using element type D or E. For element types see pages 628-629. For matching valves see pages 630-634. For indirect heating systems only. Tappings are approx. 40mm less than the width of the rail and approx. 70mm off the wall. Price includes radiator and wall fixing sets, valves extra.

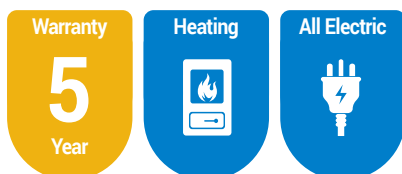

Designer Range

LEONARDO



Pictured 41.0261 Chrome

The single sided pipes on this wonderfully stylish Leonardo rail allows maximum hanging space.

FEATURES

- Manufactured and tested to EN442 standard
- 5 Year manufacturer's warranty*
- Can be reverse handed (left or right).
- Can be single or dual fuel, or all electric
- CE and NF Certificates
- * With conditions

Round Vent Caps

Page 637



Robe Hooks

Page 636

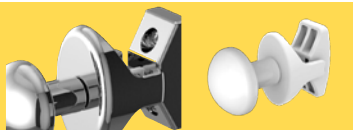

Leonardo - Chrome

Size H x W	Watts	BTU	Element Output	Element Type	Code	£ Ex VAT	£ Inc VAT
600 x 400mm	244	833	150W	A, D or E	41.0255	170.00	204.00
600 x 500mm	288	983	150W	A, D or E	41.0258	185.00	222.00
600 x 600mm	332	1133	150W	A, D or E	41.0263	201.00	241.20
688 x 500mm	324	1105	150W	A, D or E	41.0261	193.00	231.60
1200 x 400mm	465	1587	300W	A, D or E	41.0256	289.00	346.80
1200 x 500mm	465	1587	300W	A, D or E	41.0259	320.00	384.00
1200 x 600mm	631	2153	300W	A, D or E	41.0264	347.00	416.40
1450 x 500mm	658	2245	300W	A, D or E	41.0262	376.00	451.20
1800 x 400mm	665	2269	300W	A, D or E	41.0257	402.00	482.40
1800 x 500mm	780	2661	300W	A, D or E	41.0260	443.00	531.60
1800 x 600mm	896	3057	300W	A, D or E	41.0265	485.00	582.00

TECHNICAL INFORMATION

All measurements in Height by Width. Heat output based on $\Delta T60^{\circ}\text{C}$. Radiators that are electric only are restricted to the heat output of the elements. Element size can be increased to full capacity of rail if using element type D or E. For element types see pages 628-629. For matching valves see pages 630-634. For indirect heating systems only. Tappings are approx. 82mm and approx. 65mm off the wall. Price includes radiator and wall fixing sets, valves extra.

Warranty

5

Year

Heating



All Electric



Dual-Fuel



Designer Range

HURLEY

Matt Cappuccino

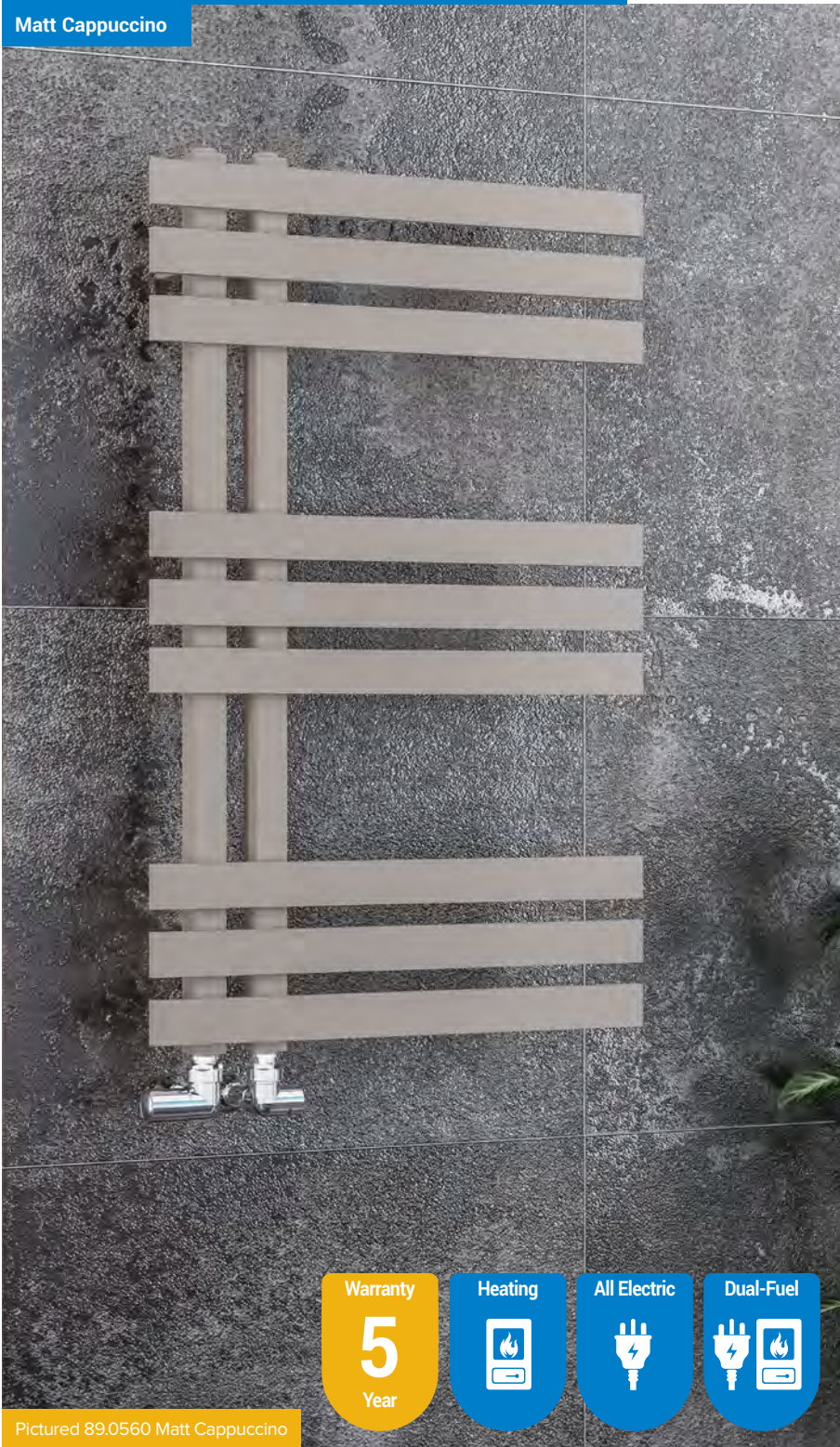

Pictured 89.0560 Matt Cappuccino

<p>Warranty</p> <p>5</p> <p>Year</p>	<p>Heating</p>	<p>All Electric</p>	<p>Dual-Fuel</p>
---	----------------	---------------------	------------------

Matt Grey



Pictured 89.0556 Matt Grey



A modern, versatile towel rail. Available in 5 colours with reversible installation possibility.

FEATURES

- Manufactured and tested to EN442 standard.
 - CE Certification.
 - 5 colours always available from stock.
 - Can be reverse handed (left or right).
 - Can be single, dual fuel or all electric.
 - 5 Year Manufacturer's Warranty*
- * With conditions



Designer Range

HURLEY

Hurley Towel Rail - Matt White							
Size H x W	Watts	BTU	Element Output	Element Type	Code	£ Ex VAT	£ Inc VAT
800 x 500mm	538	1836	300W	A, D or E	89.0542	153.00	183.60
800 x 600mm	635	2167	300W	A, D or E	89.0543	172.00	206.40
1200 x 500mm	806	2750	300W	A, D or E	89.0544	212.00	254.40
1200 x 600mm	952	3248	300W	A, D or E	89.0545	237.00	284.40
1800 x 500mm	1208	4122	600W	A, D or E	89.0546	270.00	324.00
1800 x 600mm	1426	4866	600W	A, D or E	89.0547	303.00	363.60

Hurley Towel Rail - Matt Grey							
Size H x W	Watts	BTU	Element Output	Element Type	Code	£ Ex VAT	£ Inc VAT
800 x 500mm	538	1836	300W	A, D or E	89.0554	153.00	183.60
800 x 600mm	635	2167	300W	A, D or E	89.0555	172.00	206.40
1200 x 500mm	806	2750	300W	A, D or E	89.0556	212.00	254.40
1200 x 600mm	952	3248	300W	A, D or E	89.0557	237.00	284.40
1800 x 500mm	1208	4122	600W	A, D or E	89.0558	270.00	324.00
1800 x 600mm	1426	4866	600W	A, D or E	89.0559	303.00	363.60

Hurley Towel Rail - Chrome							
Size H x W	Watts	BTU	Element Output	Element Type	Code	£ Ex VAT	£ Inc VAT
800 x 500mm	473	1614	300W	A, D or E	89.0566	195.00	234.00
800 x 600mm	559	1907	300W	A, D or E	89.0567	219.00	262.80
1200 x 500mm	709	2419	300W	A, D or E	89.0568	270.00	324.00
1200 x 600mm	837	2856	300W	A, D or E	89.0569	303.00	363.60
1800 x 500mm	1063	3627	600W	A, D or E	89.0570	375.00	450.00
1800 x 600mm	1254	4279	600W	A, D or E	89.0571	420.00	504.00

Hurley Towel Rail - Matt Anthracite							
Size H x W	Watts	BTU	Element Output	Element Type	Code	£ Ex VAT	£ Inc VAT
800x500mm	538	1836	300W	A, D or E	89.0548	153.00	183.60
800x600mm	635	2167	300W	A, D or E	89.0549	172.00	206.40
1200x500mm	806	2750	300W	A, D or E	89.0550	212.00	254.40
1200x600mm	952	3248	300W	A, D or E	89.0551	237.00	284.40
1800x500mm	1208	4122	600W	A, D or E	89.0552	270.00	324.00
1800x600mm	1426	4866	600W	A, D or E	89.0553	303.00	363.60

Hurley Towel Rail - Matt Cappuccino							
Size H x W	Watts	BTU	Element Output	Element Type	Code	£ Ex VAT	£ Inc VAT
800x500mm	538	1836	300W	A, D or E	89.0560	168.00	201.60
800x600mm	635	2167	300W	A, D or E	89.0561	189.00	226.80
1200x500mm	806	2750	300W	A, D or E	89.0562	233.00	279.60
1200x600mm	952	3248	300W	A, D or E	89.0563	261.00	313.20
1800x500mm	1208	4122	600W	A, D or E	89.0564	297.00	356.40
1800x600mm	1426	4866	600W	A, D or E	89.0565	333.00	399.60

Round Vent Caps
Page 637



TECHNICAL INFORMATION

All measurements in Height by Width. Heat output based on ▲T60°C. Radiators that are electric only are restricted to the heat output of the elements. Element size can be increased to full capacity of rail if using element type D or E. For element types see pages 628-629. For matching valves see pages 630-634. For indirect heating systems only. Tappings are approx. 60mm and approx. 79mm off the wall. Price includes radiator and wall fixing sets, valves extra.

Matt White

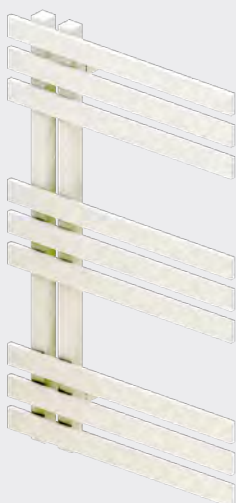

Pictured 89.0543 Matt White

Matt Anthracite

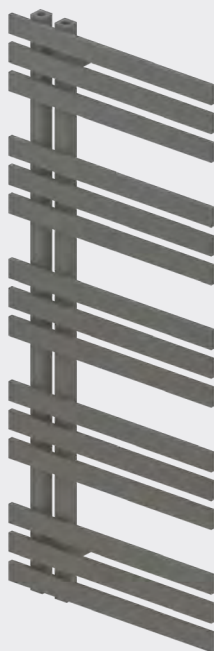

Pictured 89.0551 Matt Anthracite

Chrome

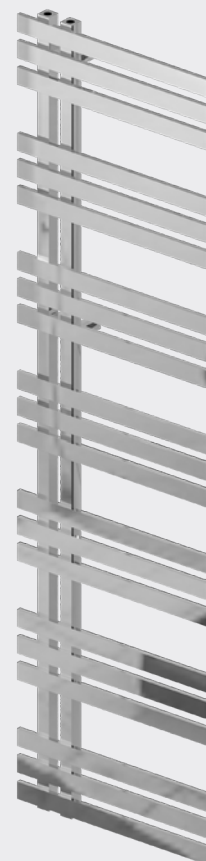

Pictured 89.0570 Chrome

Designer Range

STAVERTON - TUBE ON TUBE - STRAIGHT



Pictured 41.0334 Chrome



Pictured 41.0188 Chrome

The Staverton Tube on Tube takes the design one step further with a higher output.

Staverton - Tube on Tube - Straight White							
Size H x W	Watts	BTU	Element Output	Element Type	Code	£ Ex VAT	£ Inc VAT
600 x 400mm	364	1242	150W	A, D or E	41.0190	137.00	164.40
600 x 500mm	432	1474	150W	A, D or E	41.0193	149.00	178.80
600 x 600mm	500	1706	300W	A, D or E	41.0196	162.00	194.40
1200 x 400mm	651	2221	300W	A, D or E	41.0191	222.00	266.40
1200 x 500mm	766	2614	300W	A, D or E	41.0194	231.00	277.20
1200 x 600mm	883	3013	300W	A, D or E	41.0197	254.00	304.80
1800 x 400mm	1014	3460	600W	A, D or E	41.0192	321.00	385.20
1800 x 500mm	1198	4088	600W	A, D or E	41.0195	336.00	403.20
1800 x 600mm	1382	4715	600W	A, D or E	41.0198	371.00	445.20

FEATURES

- Manufactured and tested to EN442 standard
- 5 Year manufacturer's warranty*
- Can be single or dual fuel, or all electric
- CE and NF Certificates
- * With conditions

Staverton - Tube on Tube - Straight Chrome							
Size H x W	Watts	BTU	Element Output	Element Type	Code	£ Ex VAT	£ Inc VAT
600 x 400mm	288	983	150W	A, D or E	41.0181	239.00	286.80
600 x 500mm	340	1160	150W	A, D or E	41.0184	262.00	314.40
600 x 600mm	394	1344	150W	A, D or E	41.0187	285.00	342.00
600 x 1000mm	603	2057	300W	A, D or E	41.0333	353.00	423.60
600 x 1200mm	710	2423	300W	A, D or E	41.0334	364.00	436.80
800 x 1000mm	779	2658	300W	A, D or E	41.0335	407.00	488.40
800 x 1200mm	916	3125	300W	A, D or E	41.0336	459.00	550.80
1200 x 400mm	514	1754	300W	A, D or E	41.0182	410.00	492.00
1200 x 500mm	606	2068	300W	A, D or E	41.0185	432.00	518.40
1200 x 600mm	697	2378	300W	A, D or E	41.0188	474.00	568.80
1800 x 400mm	802	2736	300W	A, D or E	41.0183	576.00	691.20
1800 x 500mm	946	3228	300W	A, D or E	41.0186	606.00	727.20
1800 x 600mm	1092	3726	600W	A, D or E	41.0189	709.00	850.80

TECHNICAL INFORMATION

All measurements in Height by Width. Heat output based on ▲T60°C. Radiators that are electric only are restricted to the heat output of the elements. Element size can be increased to full capacity of rail if using element type D or E. For element types see pages 628-629. For matching valves see pages 630-634. For indirect heating systems only. Tappings are approx. 50mm less than the width of the rail and approx. 65mm off the wall. Price includes radiator and wall fixing sets, valves extra.

Robe Hooks

Page 636



Round Vent Caps

Page 637



Warranty

5

Year

Heating

All Electric

Dual-Fuel

Designer Range

STAVERTON - TUBE ON TUBE - CURVED



Pictured 41.0235 Chrome



Pictured 41.0241 White

Robe Hooks
Page 636

Round Vent Caps
Page 637

The Staverton tube on tube curved option allows the hanging of larger, fluffier towels for the ultimate luxury.

Staverton - Tube on Tube - Curved White							
Size H x W	Watts	BTU	Element Output	Element Type	Code	£ Ex VAT	£ Inc VAT
600 x 500mm	418	1426	150W	A, D or E	41.0238	138.00	165.60
600 x 600mm	481	1641	300W	A, D or E	41.0239	150.00	180.00
1200 x 500mm	798	2723	300W	A, D or E	41.0240	231.00	277.20
1200 x 600mm	918	3132	300W	A, D or E	41.0241	255.00	306.00
1800 x 500mm	1181	4030	600W	A, D or E	41.0242	327.00	392.40
1800 x 600mm	1355	4623	600W	A, D or E	41.0243	361.00	433.20

Staverton - Tube on Tube - Curved Chrome							
Size H x W	Watts	BTU	Element Output	Element Type	Code	£ Ex VAT	£ Inc VAT
600 x 500mm	328	1119	150W	A, D or E	41.0232	231.00	277.20
600 x 600mm	378	1290	150W	A, D or E	41.0233	254.00	304.80
1200 x 500mm	628	2143	300W	A, D or E	41.0234	407.00	488.40
1200 x 600mm	722	2463	300W	A, D or E	41.0235	446.00	535.20
1800 x 500mm	928	3166	300W	A, D or E	41.0236	578.00	693.60
1800 x 600mm	1067	3641	600W	A, D or E	41.0237	637.00	764.40

FEATURES

- Manufactured and tested to EN442 standard
- 5 Year manufacturer's warranty*
- Can be single or dual fuel, or all electric
- CE and NF Certificates
- * With conditions

TECHNICAL INFORMATION

All measurements in Height by Width. Heat output based on ▲T60°C. Radiators that are electric only are restricted to the heat output of the elements. Element size can be increased to full capacity of rail if using element type D or E. For element types see pages 628-629. For matching valves see pages 630-634. For indirect heating systems only. Tappings are approx. 45mm less than the width of the rail and approx. 65mm off the wall. Price includes radiator and wall fixing sets, valves extra.

Warranty

5

Year

Heating

All Electric

Dual-Fuel

Designer Range

STAVERTON



Pictured 41.0131 Chrome



A modern style square rail with horizontal flat bars, that still allows maximum space for keeping your towels warm.

Staverton - White							
Size H x W	Watts	BTU	Element Output	Element Type	Code	£ Ex VAT	£ Inc VAT
600 x 400mm	276	942	150W	A, D, E or F	41.0136	72.00	86.40
600 x 500mm	332	1133	150W	A, D, E or F	41.0139	79.00	94.80
600 x 600mm	388	1324	150W	A, D, E or F	41.0142	86.00	103.20
1200 x 400mm	552	1883	300W	A, D, E or F	41.0137	120.00	144.00
1200 x 500mm	665	2269	300W	A, D, E or F	41.0140	129.00	154.80
1200 x 600mm	776	2648	300W	A, D, E or F	41.0143	141.00	169.20
1800 x 400mm	829	2829	300W	A, D, E or F	41.0138	166.00	199.20
1800 x 500mm	996	3398	600W	A, D, E or F	41.0141	181.00	217.20
1800 x 600mm	1164	3972	600W	A, D, E or F	41.0144	200.00	240.00

FEATURES

- Manufactured and tested to EN442 standard
 - CE and NF Certificates
 - 5 Year manufacturer's warranty*
 - Comes in a chrome or white finish
 - Can be single or dual fuel, or all electric
- * With conditions

Staverton - Chrome							
Size H x W	Watts	BTU	Element Output	Element Type	Code	£ Ex VAT	£ Inc VAT
600 x 400mm	217	740	100W	A, D, E or F	41.0127	128.00	153.60
600 x 500mm	261	891	150W	A, D, E or F	41.0130	147.00	176.40
600 x 600mm	305	1041	150W	A, D, E or F	41.0133	153.00	183.60
1200 x 400mm	435	1484	150W	A, D, E or F	41.0128	222.00	266.40
1200 x 500mm	523	1784	300W	A, D, E or F	41.0131	246.00	295.20
1200 x 600mm	611	2085	300W	A, D, E or F	41.0134	269.00	322.80
1800 x 400mm	652	2225	300W	A, D, E or F	41.0129	317.00	380.40
1800 x 500mm	784	2675	300W	A, D, E or F	41.0132	351.00	421.20
1800 x 600mm	916	3125	300W	A, D, E or F	41.0135	389.00	466.80

TECHNICAL INFORMATION

All measurements in Height by Width. Heat output based on $\Delta T_{60}^{\circ}\text{C}$. Radiators that are electric only are restricted to the heat output of the elements. Element size can be increased to full capacity of rail if using element type D, E or F. For element types see pages 628-629. For matching valves see pages 630-634. For indirect heating systems only. Tappings are approx. 45mm less than the width of the rail and approx. 70mm off the wall. Price includes radiator and wall fixing sets, valves extra.

Warranty

5

Year

Heating

All Electric

Dual-Fuel

Designer Range

MEZZO TONDO



Pictured 41.0248 Chrome

The curves on this rail allow maximum space for the whole family to warm towels easily, without compromising on space in the room due to the slimline design.

Mezzo Tondo - White & Chrome

Size H x W	Watts	BTU	Element Output	Element Type	Code	£ Ex VAT	£ Inc VAT
1600 x 320mm Chrome	574	1958	300W	A, D or E	41.0248	289.00	346.80
1600 x 320mm White†	730	2491	300W	A, D or E	41.0249	112.00	134.40

WHILE STOCKS LAST! †

FEATURES

- Manufactured and tested to EN442 standard
- 5 Year manufacturer's warranty*
- Can be single or dual fuel, or all electric
- CE and NF Certificates
- * With conditions

TECHNICAL INFORMATION

All measurements in Height by Width. Heat output based on ▲T60°C. Radiators that are electric only are restricted to the heat output of the elements. Element size can be increased to full capacity of rail if using element type D or E. For element types see pages 628-629. For matching valves see pages 630-634. For indirect heating systems only. Tappings are approx. 286mm and approx. 65mm off the wall. Price includes radiator and wall fixing sets, valves extra.

PESARO



A designer towel rail that allows the hanging of up to six towels at once. This statement piece has a unique design for those who want to make a bold statement.

Pesaro - Chrome

Size H x W	Watts	BTU	Element Output	Element Type	Code	£ Ex VAT	£ Inc VAT
1005 x 550mm	349	1191	150W	A, D or E	41.0328	286.00	343.20

FEATURES

- Manufactured and tested to EN442 standard
- 5 Year manufacturer's warranty*
- Can be single or dual fuel, or all electric
- CE and NF Certificates
- * With conditions

TECHNICAL INFORMATION

All measurements in Height by Width. Heat output based on ▲T60°C. Radiators that are electric only are restricted to the heat output of the elements. Element size can be increased to full capacity of rail if using element type D or E. For element types see pages 628-629. For matching valves see pages 630-634. For indirect heating systems only. Tappings are approx. 80mm and approx. 65mm off the wall. Price includes radiator and wall fixing sets, valves extra.

Round Vent Caps
Page 637



Warranty

5

Year

Heating

All Electric

Dual-Fuel

Round Vent Caps
Page 637



Warranty

5

Year

Heating

All Electric

Dual-Fuel

Designer Range

TERMOLI



Pictured 41.0329 White

A modern flat panel rail, that ideally can be paired with a freestanding bath or a shower enclosure to allow your warm towels to always be within reach.

Termoli - White & Chrome

Size H x W	Watts	BTU	Element Output	Element Type	Code	£ Ex VAT	£ Inc VAT
1000 x 545mm - White	506	1690	N/A	N/A	41.0329	195.00	234.00
1000 x 545mm - Chrome	399	1334	N/A	N/A	41.0330	311.00	373.20

FEATURES

- Manufactured and tested to EN442 Standard
- 5 Year Manufacturer's Warranty*
- CE and NF Certificates
- Not suitable for Elements
- * With conditions

TECHNICAL INFORMATION

All measurements in Height by Width. Heat output based on $\Delta T60^{\circ}\text{C}$. Not suitable for elements. For matching valves see pages 630-634. Tappings are approx. 372mm and 100mm off floor. Price includes radiator and wall fixing sets, valves extra.

Robe Hooks

Page 636



VIESTE



Pictured 41.0331 White

A more traditional version of the freestanding design of the Termoli. An ideal use for these rails is where space is limited or in a wetroom application.

Vieste - White & Chrome

Size H x W	Watts	BTU	Element Output	Element Type	Code	£ Ex VAT	£ Inc VAT
1005 x 545mm - White	462	1545	N/A	N/A	41.0331	199.00	238.80
1000 x 545mm - Chrome	328	1097	N/A	N/A	41.0332	326.00	391.20

FEATURES

- Manufactured and tested to EN442 standard
- 5 Year manufacturer's warranty*
- Can be single or dual fuel, or all electric
- CE and NF Certificates
- * With conditions

TECHNICAL INFORMATION

All measurements in Height by Width. Heat output based on $\Delta T60^{\circ}\text{C}$. Not suitable for elements. For matching valves see pages 630-634. Tappings are approx. 372mm and 100mm off floor. Price includes radiator and wall fixing sets, valves extra.

Robe Hooks

Page 636



Designer Range

BIAVA CORINIUM



Pictured 41.0224 Chrome

The Corinium rail is a contemporary unique design with a practical built in heated towel rail shelf at the top for stacking those larger towels. It's projection from the wall is 225mm.

Biava Corinium

Size H x W	Watts	BTU	Element Output	Element Type	Code	£ Ex VAT	£ Inc VAT
1200 x 500mm White†	387	1320	150W	A, C or E	41.0223	82.00	98.40
1200 x 500mm Chrome	304	1037	150W	A, C or E	41.0222	174.00	208.80
1200 x 600mm White†	420	1433	150W	A, C or E	41.0225	84.00	100.80
1200 x 600mm Chrome	330	1126	150W	A, C or E	41.0224	182.00	218.40

WHILE STOCKS LAST! †

FEATURES

- Manufactured and tested to EN442 standard
 - 5 Year manufacturer's warranty*
 - Can be single or dual fuel, or all electric
 - CE and NF Certificates
- * With conditions

TECHNICAL INFORMATION

All measurements in Height by Width. Heat output based on ▲T60°C. Radiators that are electric only are restricted to the heat output of the elements. Element size can be increased to full capacity of rail if using element type C or E. For element types see pages 628-629. For matching valves see pages 630-634. For indirect heating systems only. Tappings are approx. 80mm less than the width of the rail. Price includes radiator and wall fixing sets, valves extra.

Warranty

5

Year

Heating

All Electric

Dual-Fuel

RUBIN

50% OFF



Pictured 41.0229 Chrome

The Rubin rail combines function with style by using single sided pipes for ultimate towel hanging ease. The rounded pipes work well with other chrome & rounded bathroom products.

Rubin - Chrome						WAS	NOW JUST	
Size H x W	Watts	BTU	Element Output	Element Type	Code	£ Ex VAT	£ Ex VAT	£ Inc VAT
600 x 500mm†	153	523	100W	A, D or E	41.0226	137.00	68.00	81.60
600 x 600mm†	175	598	100W	A, D or E	41.0229	146.00	73.00	87.60

WHILE STOCKS LAST! †

FEATURES

- Manufactured and tested to EN442 standard
 - 5 Year manufacturer's warranty*
 - Can be reverse handed (left or right).
 - Can be single or dual fuel, or all electric
 - CE and NF Certificates
- * With conditions

TECHNICAL INFORMATION

All measurements in Height by Width. Heat output based on ▲T60°C. Radiators that are electric only are restricted to the heat output of the elements. Element size can be increased to full capacity of rail if using element type D or E. For element types see pages 628-629. For matching valves see pages 630-634. For indirect heating systems only. Tappings are approx. 100mm and approx. 75mm off the wall. Price includes radiator and wall fixing sets, valves extra.

Round Vent Caps

Page 637



Warranty

5

Year

Heating

All Electric

Dual-Fuel

Designer Range

MARLOW

Matt Anthracite



Pictured 89.0509 Matt Anthracite

Warranty
5
Year

Diameter (Ø)
42
MM Bars

Heating

A brand new edition to the Eastbrook Multirail Range. Available in a variety of colours to suit any bathroom. The generous spacing between the horizontal tubes allows for maximum towel drying.

FEATURES

- 42mm diameter horizontal & vertical round profiles.
- Manufactured and tested to EN442 standard.
- CE Certification.
- 5 colours always available from stock.
- State-of-the-art welding technology.
- 5 Year Manufacturer's Warranty*
- * With conditions



SWATCHES AVAILABLE

Chrome



Pictured 89.0525 Chrome

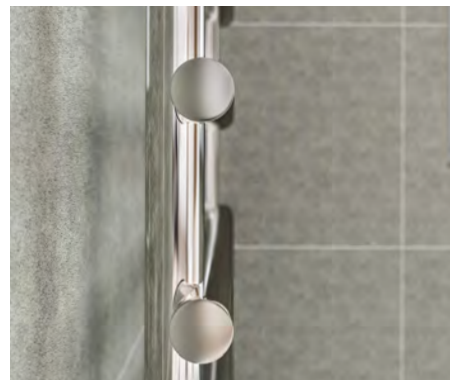

Round Vent Caps
Page 637

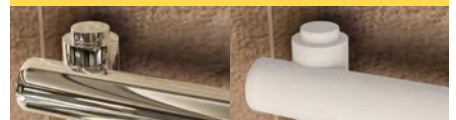

Designer Range

Marlow Towel Rail - Matt White							
Size H x W	Watts	BTU	Element Output	Element Type	Code	£ Ex VAT	£ Inc VAT
850 x 500mm	396	1351	N/A	N/A	89.0500	222.00	266.40
850 x 600mm	445	1518	N/A	N/A	89.0501	235.00	282.00
1150 x 500mm	529	1805	N/A	N/A	89.0502	274.00	328.80
1150 x 600mm	594	2027	N/A	N/A	89.0503	291.00	349.20
1750 x 500mm	798	2723	N/A	N/A	89.0504	364.00	436.80
1750 x 600mm	896	3057	N/A	N/A	89.0505	386.00	463.20

Marlow Towel Rail - Matt Grey							
Size H x W	Watts	BTU	Element Output	Element Type	Code	£ Ex VAT	£ Inc VAT
850 x 500mm	396	1351	N/A	N/A	89.0512	222.00	266.40
850 x 600mm	445	1518	N/A	N/A	89.0513	235.00	282.00
1150 x 500mm	529	1805	N/A	N/A	89.0514	274.00	328.80
1150 x 600mm	594	2027	N/A	N/A	89.0515	291.00	349.20
1750 x 500mm	798	2723	N/A	N/A	89.0516	364.00	436.80
1750 x 600mm	896	3057	N/A	N/A	89.0517	386.00	463.20

Marlow Towel Rail - Chrome							
Size H x W	Watts	BTU	Element Output	Element Type	Code	£ Ex VAT	£ Inc VAT
850 x 500mm	265	904	N/A	N/A	89.0524	308.00	369.60
850 x 600mm	297	1013	N/A	N/A	89.0525	327.00	392.40
1150 x 500mm	355	1211	N/A	N/A	89.0526	381.00	457.20
1150 x 600mm	398	1357	N/A	N/A	89.0527	404.00	484.80
1750 x 500mm	533	1819	N/A	N/A	89.0528	506.00	607.20
1750 x 600mm	599	2044	N/A	N/A	89.0529	536.00	643.20

MARLOW Marlow Towel Rail - Matt Anthracite							
Size H x W	Watts	BTU	Element Output	Element Type	Code	£ Ex VAT	£ Inc VAT
850 x 500mm	396	1351	N/A	N/A	89.0506	222.00	266.40
850 x 600mm	445	1518	N/A	N/A	89.0507	235.00	282.00
1150 x 500mm	529	1805	N/A	N/A	89.0508	274.00	328.80
1150 x 600mm	594	2027	N/A	N/A	89.0509	291.00	349.20
1750 x 500mm	798	2723	N/A	N/A	89.0510	364.00	436.80
1750 x 600mm	896	3057	N/A	N/A	89.0511	386.00	463.20

Marlow Towel Rail - Matt Cappuccino							
Size H x W	Watts	BTU	Element Output	Element Type	Code	£ Ex VAT	£ Inc VAT
850 x 500mm	396	1351	N/A	N/A	89.0518	244.00	292.80
850 x 600mm	445	1518	N/A	N/A	89.0519	259.00	310.80
1150 x 500mm	529	1805	N/A	N/A	89.0520	302.00	362.40
1150 x 600mm	594	2027	N/A	N/A	89.0521	320.00	384.00
1750 x 500mm	798	2723	N/A	N/A	89.0522	401.00	481.20
1750 x 600mm	896	3057	N/A	N/A	89.0523	425.00	510.00

TECHNICAL INFORMATION

All measurements in Height by Width. Heat output based on ▲T60°C. Not suitable for elements. For matching valves see pages 630-634. For indirect heating systems only. Tappings are approx. 82mm less than the width of the rail and approx. 95mm off the wall. Price includes radiator and wall fixing sets, valves extra.



Designer Range

RYTON



Pictured 61.0017 Chrome



Framed rectangular multirail available in a variety of finishes to create a stylish focal point in any bathroom.

FEATURES

- Manufactured and tested to EN442 standard.
- CE Certification.
- A brave alternative for a basic towel radiator.
- Can be single, dual fuel or all electric.
- 5 Year Manufacturer's Warranty*

* With conditions

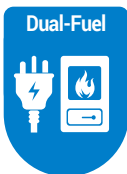

TECHNICAL INFORMATION

All measurements in Height by Width. Heat output based on $\Delta T60^{\circ}\text{C}$. Radiators that are electric only are restricted to the heat output of the elements. Element size can be increased to full capacity of rail if using element type D or E. For element types see pages 628-629. For matching valves see pages 630-634. For indirect heating systems only. Tappings are approx. 30mm less than the width of the rail and approx. 75-90mm off the wall. Price includes radiator and wall fixing sets, valves extra.

Designer Range

Ryton Towel Rail - Matt White

Size H x W	Watts	BTU	Element Output	Element Type	Code	£ Ex VAT	£ Inc VAT
800 x 500mm	253	863	150W	A, D or E	61.0002	165.00	198.00
800 x 600mm	279	951	150W	A, D or E	61.0003	180.00	216.00
1200 x 500mm	379	1293	150W	A, D or E	61.0004	206.00	247.20
1200 x 600mm	418	1425	150W	A, D or E	61.0005	225.00	270.00
1600 x 500mm	505	1722	300W	A, D or E	61.0006	263.00	315.60
1600 x 600mm	556	1898	300W	A, D or E	61.0007	287.00	344.40

Ryton Towel Rail - Matt Anthracite

Size H x W	Watts	BTU	Element Output	Element Type	Code	£ Ex VAT	£ Inc VAT
800 x 500mm	253	863	150W	A, D or E	61.0008	165.00	198.00
800 x 600mm	279	951	150W	A, D or E	61.0009	180.00	216.00
1200 x 500mm	379	1293	150W	A, D or E	61.0010	206.00	247.20
1200 x 600mm	418	1425	150W	A, D or E	61.0011	225.00	270.00
1600 x 500mm	505	1722	300W	A, D or E	61.0012	263.00	315.60
1600 x 600mm	556	1898	300W	A, D or E	61.0013	287.00	344.40

RYTON Towel Rail - Chrome

Size H x W	Watts	BTU	Element Output	Element Type	Code	£ Ex VAT	£ Inc VAT
800 x 500mm	168	572	100W	A, D or E	61.0014	248.00	297.60
800 x 600mm	185	630	100W	A, D or E	61.0015	278.00	333.60
1200 x 500mm	251	856	150W	A, D or E	61.0016	313.00	375.60
1200 x 600mm	277	944	150W	A, D or E	61.0017	350.00	420.00
1600 x 500mm	334	1141	150W	A, D or E	61.0018	379.00	454.80
1600 x 600mm	368	1257	150W	A, D or E	61.0019	425.00	510.00

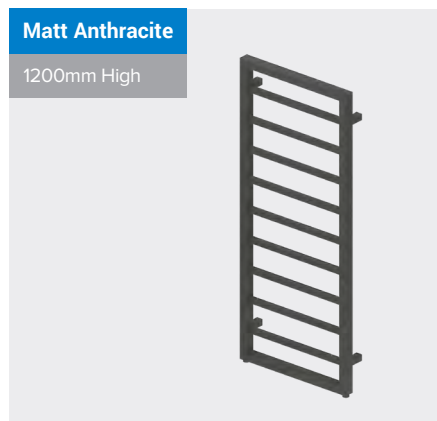
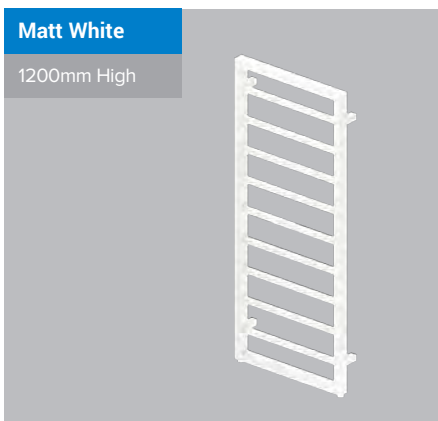
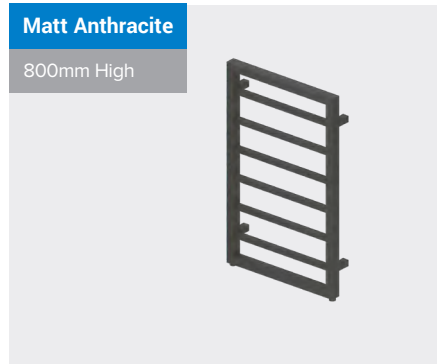
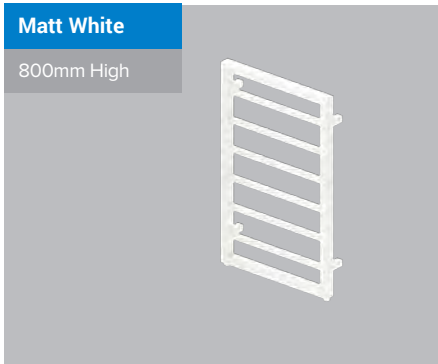

Designer Range

KENILWORTH



Pictured 61.0032 Chrome

A contemporary take on a traditional multirail. This framed design available in a variety of colours will be sure to suit any bathroom.

FEATURES

- Manufactured and tested to EN442 standard.
 - CE Certification.
 - A brave alternative for a basic towel radiator.
 - Can be single, dual fuel or all electric.
 - 5 Year Manufacturer's Warranty*
- * With conditions



TECHNICAL INFORMATION

All measurements in Height by Width. Heat output based on $\Delta T60^{\circ}\text{C}$. Radiators that are electric only are restricted to the heat output of the elements. Element size can be increased to full capacity of rail if using element type D or E. For element types see pages 628-629. For matching valves see pages 630-634. For indirect heating systems only. Tappings are approx. 32mm less than the width of the rail and approx. 76-91mm off the wall. Price includes radiator and wall fixing sets, valves extra.

Designer Range

Kenilworth Towel Rail - Matt White

Size H x W	Watts	BTU	Element Output	Element Type	Code	£ Ex VAT	£ Inc VAT
800 x 500mm	252	860	150W	A, D or E	61.0020	157.00	188.40
800 x 600mm	280	956	150W	A, D or E	61.0021	172.00	206.40
1200 x 500mm	378	1289	150W	A, D or E	61.0022	199.00	238.80
1200 x 600mm	420	1432	150W	A, D or E	61.0023	217.00	260.40
1600 x 500mm	503	1717	300W	A, D or E	61.0024	255.00	306.00
1600 x 600mm	559	1908	300W	A, D or E	61.0025	279.00	334.80

Kenilworth Towel Rail - Matt Anthracite

Size H x W	Watts	BTU	Element Output	Element Type	Code	£ Ex VAT	£ Inc VAT
800 x 500mm	252	863	150W	A, D or E	61.0026	157.00	188.40
800 x 600mm	280	956	150W	A, D or E	61.0027	172.00	206.40
1200 x 500mm	378	1289	150W	A, D or E	61.0028	199.00	238.80
1200 x 600mm	420	1432	150W	A, D or E	61.0029	217.00	260.40
1600 x 500mm	503	1717	300W	A, D or E	61.0030	255.00	306.00
1600 x 600mm	559	1908	300W	A, D or E	61.0031	279.00	334.80

KENILWORTH

Kenilworth Towel Rail - Chrome

Size H x W	Watts	BTU	Element Output	Element Type	Code	£ Ex VAT	£ Inc VAT
800 x 500mm	167	570	100W	A, D or E	61.0032	237.00	284.40
800 x 600mm	186	633	100W	A, D or E	61.0033	265.00	318.00
1200 x 500mm	250	854	150W	A, D or E	61.0034	301.00	361.20
1200 x 600mm	278	948	150W	A, D or E	61.0035	337.00	404.40
1600 x 500mm	333	1137	150W	A, D or E	61.0036	364.00	436.80
1600 x 600mm	370	1264	150W	A, D or E	61.0037	407.00	488.40

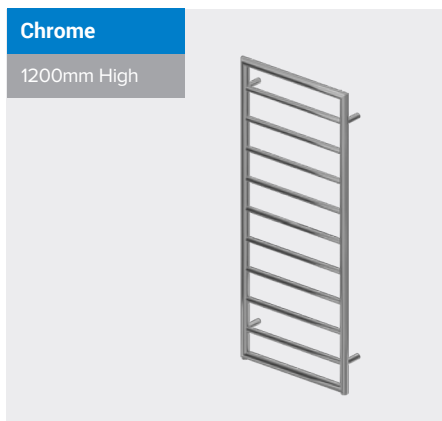
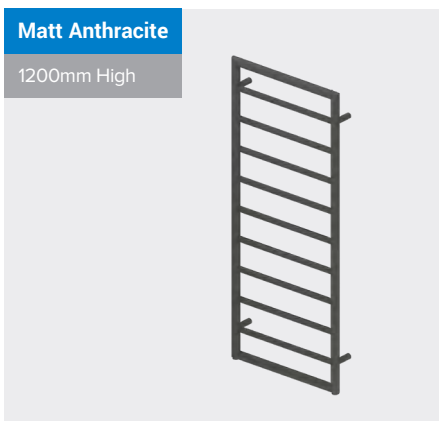
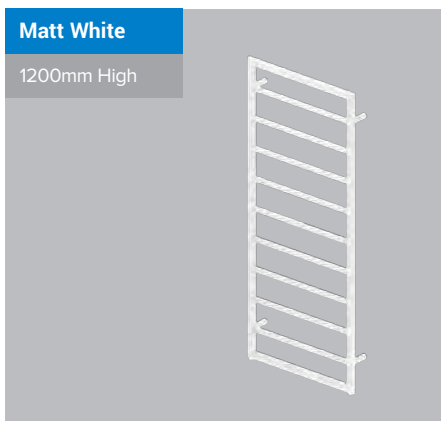
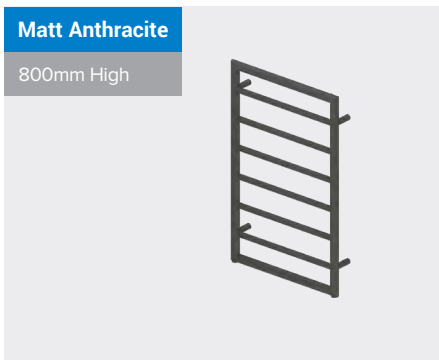
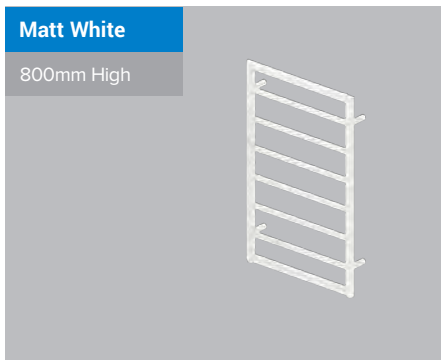

Designer Range

LOXLEY



Pictured 61.0047 Chrome

The Loxley range features contemporary clean lines. The square tubes and profiles gives this towel rail an ultra-modern look.

FEATURES

- Manufactured and tested to EN442 standard.
- CE Certification.
- Modern adaption of a traditional design.
- Concealed wall brackets
- Can be single, dual fuel** or all electric**.
- 5 Year Manufacturer's Warranty*

* With conditions

** Only certain sizes, see table

Warranty

5

Year

Heating

All Electric

Dual-Fuel

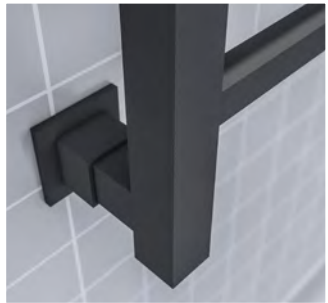

TECHNICAL INFORMATION

All measurements in Height by Width. Heat output based on $\Delta T60^{\circ}\text{C}$. Radiators that are electric only are restricted to the heat output of the elements. Element size can be increased to full capacity of rail if using element type D or E. For element types see pages 628-629. For matching valves see pages 630-634. For indirect heating systems only. Tappings are approx. 59mm less than the width of the rail and

Designer Range

LOXLEY

Loxley Towel Rail - Matt White

Size H x W	Watts	BTU	Element Output	Element Type	Code	£ Ex VAT	£ Inc VAT
800 x 500mm	194	663	100W	A, D or E	61.0038	261.00	313.20
800 x 600mm	216	736	100W	A, D or E	61.0039	285.00	342.00
1200 x 500mm	291	993	150W	A, D or E	61.0040	288.00	345.60
1200 x 600mm	323	1102	150W	A, D or E	61.0041	314.00	376.80

Loxley Towel Rail - Matt Anthracite

Size H x W	Watts	BTU	Element Output	Element Type	Code	£ Ex VAT	£ Inc VAT
800 x 500mm	194	663	100W	A, D or E	61.0042	261.00	313.20
800 x 600mm	216	736	100W	A, D or E	61.0043	285.00	342.00
1200 x 500mm	291	993	150W	A, D or E	61.0044	288.00	345.60
1200 x 600mm	323	1102	150W	A, D or E	61.0045	314.00	376.80

Loxley Towel Rail - Chrome

Size H x W	Watts	BTU	Element Output	Element Type	Code	£ Ex VAT	£ Inc VAT
800 x 500mm	129	439	N/A	N/A	61.0046	317.00	380.40
800 x 600mm	143	487	N/A	N/A	61.0047	356.00	427.20
1200 x 500mm	193	658	100W	A, D or E	61.0048	357.00	428.40
1200 x 600mm	214	730	100W	A, D or E	61.0049	400.00	480.00

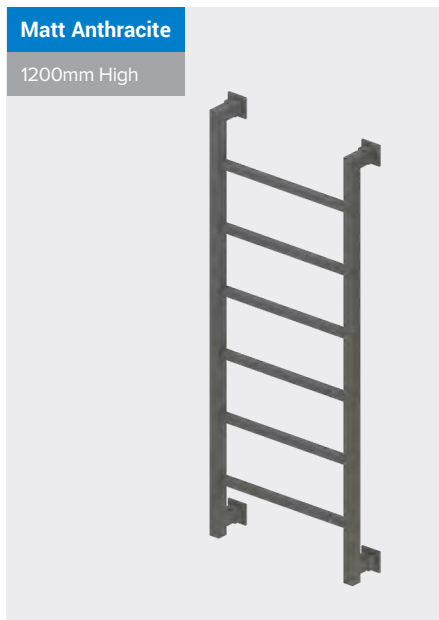
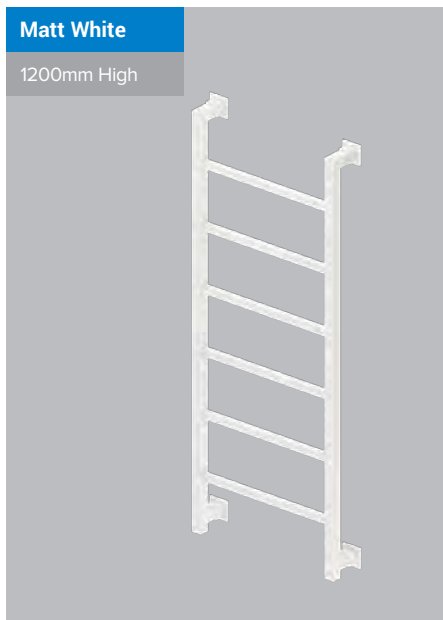
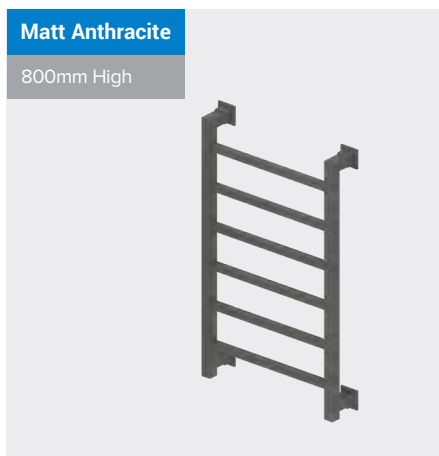

Designer Range

ESHTON



Pictured 61.0056 Matt Anthracite



A fresh take on the traditional towel rail. The Eshton range features both round tubes and profiles for a complete contemporary look.

FEATURES

- Manufactured and tested to EN442 standard.
 - CE Certification.
 - Modern adaption of a traditional design.
 - Concealed wall brackets
 - Can be single, dual fuel or all electric.
 - 5 Year Manufacturer's Warranty*
- * With conditions



TECHNICAL INFORMATION

All measurements in Height by Width. Heat output based on $\Delta T60^{\circ}\text{C}$. Radiators that are electric only are restricted to the heat output of the elements. Element size can be increased to full capacity of rail if using element type D or E. For element types see pages 628-629. For matching valves see pages 630-634. For indirect heating systems only. Tappings are approx. 59mm less than the width of the rail and approx. 77mm off the wall. Price includes radiator and wall fixing sets, valves extra.

Designer Range

Eshton Towel Rail - Matt White							
Size H x W	Watts	BTU	Element Output	Element Type	Code	£ Ex VAT	£ Inc VAT
800 x 500mm	248	848	150W	A, D or E	61.0050	237.00	284.40
800 x 600mm	276	942	150W	A, D or E	61.0051	259.00	310.80
1200 x 500mm	372	1270	150W	A, D or E	61.0052	265.00	318.00
1200 x 600mm	413	1411	150W	A, D or E	61.0053	289.00	346.80

Eshton Towel Rail - Matt Anthracite							
Size H x W	Watts	BTU	Element Output	Element Type	Code	£ Ex VAT	£ Inc VAT
800 x 500mm	248	848	150W	A, D or E	61.0054	237.00	284.40
800 x 600mm	276	942	150W	A, D or E	61.0055	259.00	310.80
1200 x 500mm	372	1270	150W	A, D or E	61.0056	265.00	318.00
1200 x 600mm	413	1411	150W	A, D or E	61.0057	289.00	346.80

ESHTON							
Eshton Towel Rail - Chrome							
Size H x W	Watts	BTU	Element Output	Element Type	Code	£ Ex VAT	£ Inc VAT
800 x 500mm	165	561	100W	A, D or E	61.0058	293.00	351.60
800 x 600mm	183	624	100W	A, D or E	61.0059	329.00	394.80
1200 x 500mm	246	841	150W	A, D or E	61.0060	334.00	400.80
1200 x 600mm	274	934	150W	A, D or E	61.0061	367.00	440.40

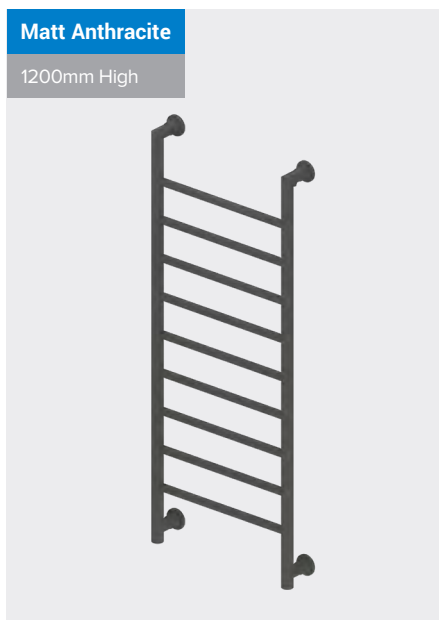
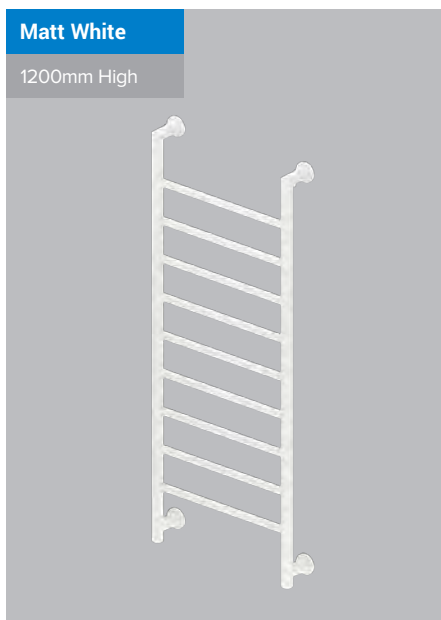
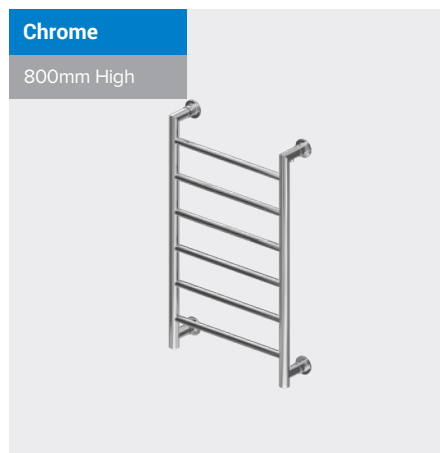
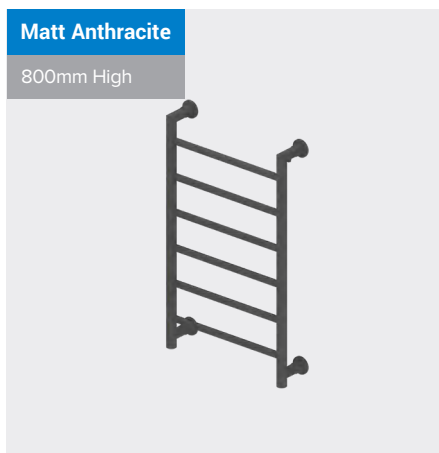

Designer Range

RUBANO VERTICAL

Pictured 81.0058 Gloss White

Warranty

5
Year

Heating



All Electric



Dual-Fuel



Close-up without vent caps

A modern take on the traditional radiator. The range features larger profiles for a more contemporary look. Available in gloss white, matt anthracite and a range of sizes makes the Rubano an ideal radiator for any household room.

Rubano Vertical - Gloss White

Size H x W	Watts	BTU	Element Output	Element Type	Code	£ Ex VAT	£ Inc VAT
1800 x 383mm	1658	5654	300W	A or C	81.0058	261.00	313.20
1800 x 503mm	2210	7536	300W	A or C	81.0059	347.00	416.40

Rubano Vertical - Matt Anthracite

Size H x W	Watts	BTU	Element Output	Element Type	Code	£ Ex VAT	£ Inc VAT
1800 x 383mm	1658	5654	300W	A or C	81.0064	266.00	319.20
1800 x 503mm	2210	7536	300W	A or C	81.0065	354.00	424.80

Rubano Radiator Feet

Description	Code	£ Ex VAT	£ Inc VAT
Rubano Radiator Feet (pair) White	81.0066	20.00	24.00
Rubano Radiator Feet (pair) Matt Anthracite	81.0067	20.00	24.00

Round Vent Caps

Page 637



Designer Range

RUBANO HORIZONTAL



Pictured 81.0062 Matt Anthracite

A modern take on the traditional radiator. The range features larger profiles for a more contemporary look. Available in gloss white, matt anthracite and a range of sizes makes the Rubano an ideal radiator for any household room.

Rubano Horizontal Radiators - Gloss White

Size H x W	Watts	BTU	Element Output	Element Type	Code	£ Ex VAT	£ Inc VAT
600 x 383mm	553	1886	300W	A	81.0054	103.00	123.60
600 x 623mm	921	3141	300W	A, C or E	81.0055	171.00	205.20
600 x 803mm	1197	4082	600W	A, C or E	81.0056	223.00	267.60
600 x 1103mm	1658	5654	900W	A or C	81.0057	308.00	369.60

Rubano Horizontal Radiators - Matt Anthracite

Size H x W	Watts	BTU	Element Output	Element Type	Code	£ Ex VAT	£ Inc VAT
600 x 383mm	553	1886	300W	A	81.0060	105.00	126.00
600 x 623mm	921	3141	300W	A, C or E	81.0061	174.00	208.80
600 x 803mm	1197	4082	600W	A, C or E	81.0062	227.00	272.40
600 x 1103mm	1658	5654	900W	A or C	81.0063	314.00	376.80

Rubano Radiator Feet

Description	Code	£ Ex VAT	£ Inc VAT
Rubano Radiator Feet (pair) White	81.0066	20.00	24.00
Rubano Radiator Feet (pair) Matt Anthracite	81.0067	20.00	24.00

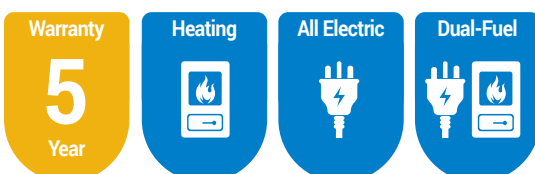

FEATURES

- Manufactured and tested to EN442 standard.
 - CE Certification.
 - Modern style column radiator.
 - Radiator feet option available to get the modern look.
 - Does not require flow diverter.
 - Can be single, dual fuel or all electric.
 - 5 Year Manufacturer's Warranty*
- * With conditions

TECHNICAL INFORMATION

All measurements in Height by Width. Heat output based on $\Delta T_{60}^{\circ}\text{C}$. Radiators that are electric only are restricted to the heat output of the elements. Element size can be increased to full capacity of rail if using element type C or E. For element types see pages 628-629. For matching valves see pages 630-634. For indirect heating systems only. Tappings are approx. the width of the rail and 74mm off the wall. Price includes radiator and wall fixing sets, valves extra.

Optional Extra: Rubano Radiator Feet



Round Vent Caps Page 637



Designer Range

ROWSHAM HORIZONTAL



Pictured 89.0098 Matt White

The Rowsham Horizontal is a designer radiator with stunning clean lines that complement any room.

Rowsham Horizontal - Matt White

Size H x W	Watts	BTU	Code	£ Ex VAT	£ Inc VAT
600 x 580mm	702	2395	89.0098	194.00	232.80
600 x 780mm	944	3221	89.0099	217.00	260.40
600 x 980mm	1186	4047	89.0100	248.00	297.60
600 x 1180mm	1429	4876	89.0101	290.00	348.00

Rowsham Horizontal - Matt Anthracite

Size H x W	Watts	BTU	Code	£ Ex VAT	£ Inc VAT
600 x 580mm	702	2395	89.0105	194.00	232.80
600 x 780mm	944	3221	89.0106	217.00	260.40
600 x 980mm	1186	4047	89.0107	248.00	297.60
600 x 1180mm	1429	4876	89.0108	290.00	348.00

FEATURES

- Comes with pre-fitted flow diverter
- Manufactured and tested to EN442 standard
- 5 Year manufacturer's warranty*
- Not suitable for elements
- CE Certificated
- * With conditions

Round Vent Caps

Page 637



TECHNICAL INFORMATION

All measurements in Height by Width. Heat output based on $\Delta T60^{\circ}\text{C}$. For matching valves see pages 630-634. For indirect heating systems only. Tappings are the width of the rail and approx. 54mm off the wall. Price includes radiator and wall fixing sets, valves extra.

Warranty

5
Year

Heating



Optional Extra - Towel Hanger - Chrome

Description	Code	£ Ex VAT	£ Inc VAT
Towel Hanger 300mm	89.0112	42.00	50.40

Compatible with Vertical and Horizontal Radiators. Must be fitted before installation (horizontal radiators only).

Designer Range

ROWSHAM VERTICAL



Pictured 89.0111 Matt Anthracite

The Rowsham Vertical is a designer radiator with stunning clean lines that complement any room.

Rowsham Vertical - Matt White					
Size H x W	Watts	BTU	Code	£ Ex VAT	£ Inc VAT
1800 x 300mm	902	3078	89.0102	208.00	249.60
1800 x 380mm	1142	3897	89.0103	267.00	320.40
1800 x 500mm	1503	5128	89.0104	276.00	331.20

Rowsham Vertical - Matt Anthracite					
Size H x W	Watts	BTU	Code	£ Ex VAT	£ Inc VAT
1800 x 300mm	902	3078	89.0109	208.00	249.60
1800 x 380mm	1142	3897	89.0110	267.00	320.40
1800 x 500mm	1503	5128	89.0111	276.00	331.20

FEATURES

- Comes with pre-fitted flow diverter
- Manufactured and tested to EN442 standard
- 5 Year manufacturer's warranty*
- Not suitable for elements
- CE Certificates
- * With conditions

Round Vent Caps

Page 637

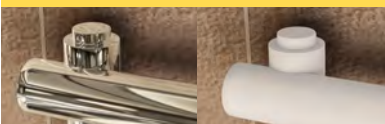

TECHNICAL INFORMATION

All measurements in Height by Width. Heat output based on $\Delta T60^{\circ}\text{C}$. For matching valves see pages 630-634. For indirect heating systems only. Tappings are the width of the rail and approx. 54mm off the wall. Price includes radiator and wall fixing sets, valves extra.

Warranty

5
Year

Heating



Optional Extra - Towel Hanger - Chrome

Description	Code	£ Ex VAT	£ Inc VAT
Towel Hanger 300mm	89.0112	42.00	50.40

Compatible with Vertical and Horizontal Radiators. Can be fitted after installation (vertical radiators only).

Designer Range

TUNSTALL VERTICAL



Pictured 89.0008 Chrome & 101.0035 Towel Hanger

Warranty

5

Year

Heating

Create a fresh new look with this elegant designer radiator which will suit any room in the house. Available in four colour finishes.

FEATURES

- Comes with pre-fitted flow diverter
- Manufactured and tested to EN442 standard
- 5 Year manufacturer's warranty*
- CE and NF Certificates
- Not suitable for elements
- * With conditions

Round Vent Caps

Page 637



Robe Hooks

Page 636

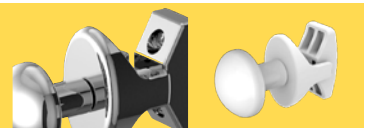

Designer Range

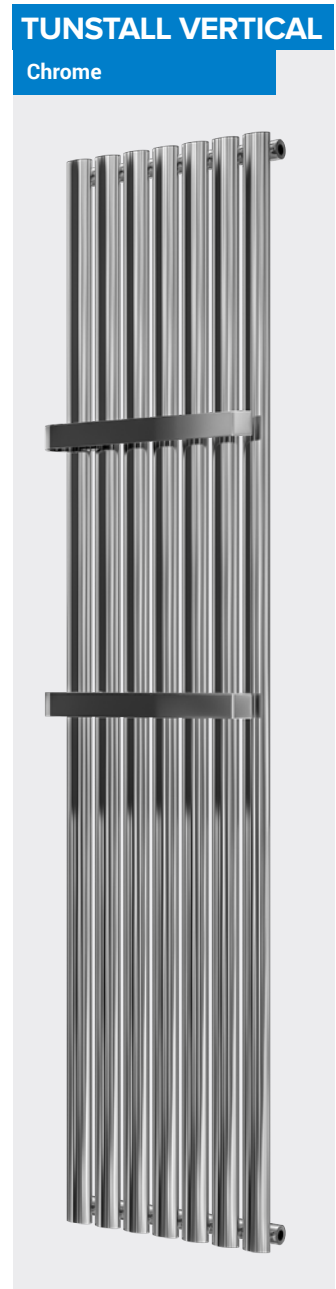
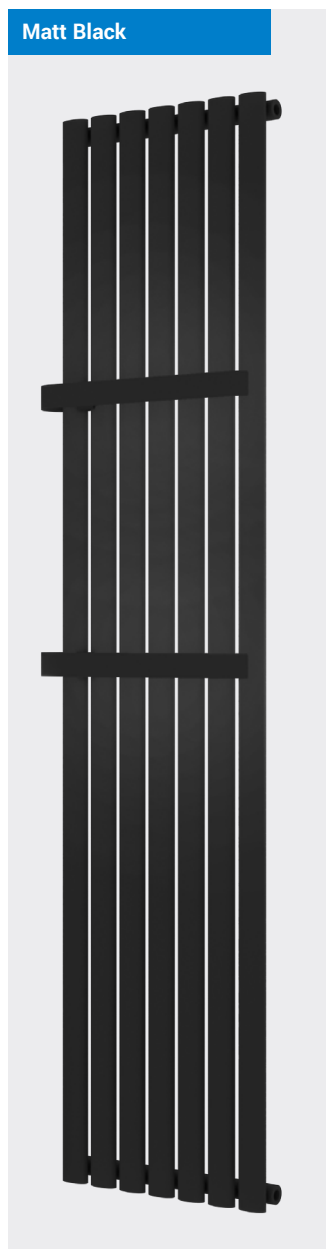
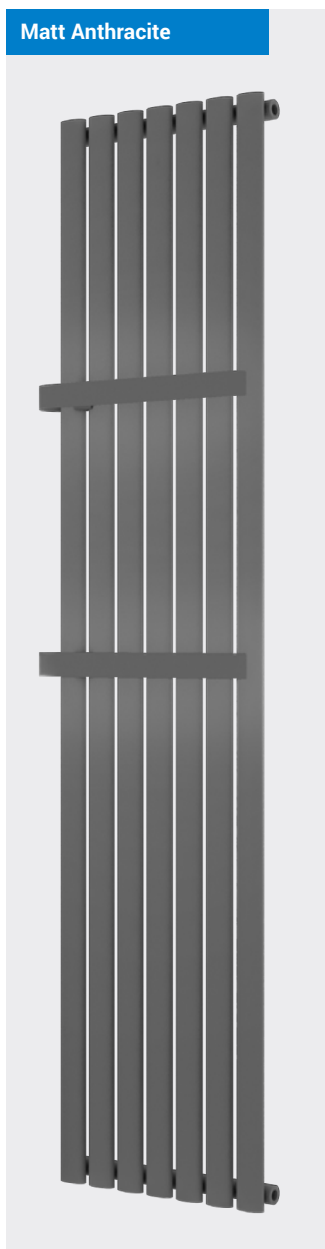

Tunstall Vertical Radiators - Matt White							
Size H x W	Watts	BTU	Element Output	Element Type	Code	£ Ex VAT	£ Inc VAT
1800 x 280mm	595	2030	N/A	N/A	89.0001	99.00	118.80
1800 x 420mm	894	3050	N/A	N/A	89.0005	135.00	162.00
1800 x 630mm	1341	4576	N/A	N/A	89.0009	214.00	256.80

Tunstall Vertical Radiators - Matt Black							
Size H x W	Watts	BTU	Element Output	Element Type	Code	£ Ex VAT	£ Inc VAT
1800 x 280mm	595	2030	N/A	N/A	89.0003	99.00	118.80
1800 x 420mm	894	3050	N/A	N/A	89.0007	135.00	162.00
1800 x 630mm	1341	4576	N/A	N/A	89.0011	214.00	256.80

Tunstall Vertical Radiators - Matt Anthracite							
Size H x W	Watts	BTU	Element Output	Element Type	Code	£ Ex VAT	£ Inc VAT
1800 x 280mm	595	2030	N/A	N/A	89.0002	99.00	118.80
1800 x 420mm	894	3050	N/A	N/A	89.0006	135.00	162.00
1800 x 630mm	1341	4576	N/A	N/A	89.0010	214.00	256.80

Tunstall Vertical Radiators - Chrome							
Size H x W	Watts	BTU	Element Output	Element Type	Code	£ Ex VAT	£ Inc VAT
1800 x 280mm	401	1368	N/A	N/A	89.0004	231.00	277.20
1800 x 420mm	602	2054	N/A	N/A	89.0008	267.00	320.40
1800 x 630mm	902	3078	N/A	N/A	89.0012	354.00	424.80

TECHNICAL INFORMATION

All measurements in Height by Width. Heat output based on $\Delta T60^{\circ}\text{C}$. For matching valves see pages 630-634. For indirect heating systems only. Tappings are the width of the rail and approx. 52mm off the wall. Price includes radiator and wall fixing sets, valves extra.

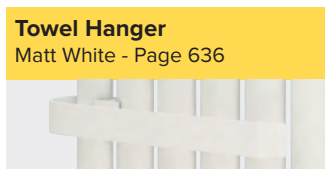

Towel Hanger
Matt White - Page 636

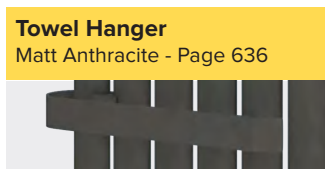

Towel Hanger
Matt Anthracite - Page 636

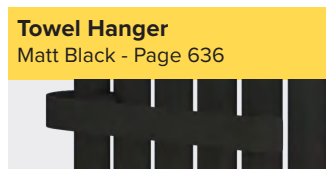

Towel Hanger
Matt Black - Page 636

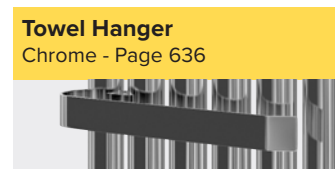

Towel Hanger
Chrome - Page 636

Designer Range

TUNSTALL HORIZONTAL



Pictured 89.0020 Matt Anthracite

The elliptical shape of these tubes will provide a stylish focus to any room. Available in four colours.

FEATURES

- Comes with pre-fitted flow diverter
 - Manufactured and tested to EN442 standard
 - 5 Year manufacturer's warranty*
 - CE and NF Certificates
 - Not suitable for elements
- * With conditions

Tunstall Horizontal Radiators - Matt White

Size H x W	Watts	BTU	Element Output	Element Type	Code	£ Ex VAT	£ Inc VAT
600 x 589mm	541	1846	N/A	N/A	89.0013	89.00	106.80
600 x 825mm	757	2583	N/A	N/A	89.0016	123.00	147.60
600 x 1002mm	920	3139	N/A	N/A	89.0019	150.00	180.00
600 x 1179mm	1082	3692	N/A	N/A	89.0022	175.00	210.00

Tunstall Horizontal Radiators - Matt Anthracite

Size H x W	Watts	BTU	Element Output	Element Type	Code	£ Ex VAT	£ Inc VAT
600 x 589mm	541	1846	N/A	N/A	89.0014	89.00	106.80
600 x 825mm	757	2583	N/A	N/A	89.0017	123.00	147.60
600 x 1002mm	920	3139	N/A	N/A	89.0020	150.00	180.00
600 x 1179mm	1082	3692	N/A	N/A	89.0023	175.00	210.00

Tunstall Horizontal Radiators - Matt Black

Size H x W	Watts	BTU	Element Output	Element Type	Code	£ Ex VAT	£ Inc VAT
600 x 589mm	541	1846	N/A	N/A	89.0015	89.00	106.80
600 x 825mm	757	2583	N/A	N/A	89.0018	123.00	147.60
600 x 1002mm	920	3139	N/A	N/A	89.0021	150.00	180.00
600 x 1179mm	1082	3692	N/A	N/A	89.0024	175.00	210.00

Warranty

5
Year

Heating



Round Vent Caps

Page 637



Towel Hanger

Matt White - Page 636



Towel Hanger

Matt Anthracite - Page 636

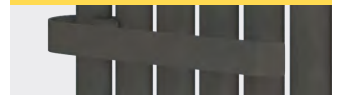

Towel Hanger

Matt Black - Page 636



Towel Hanger

Chrome - Page 636



TECHNICAL INFORMATION

All measurements in Height by Width. Heat output based on $\Delta T60^{\circ}\text{C}$. For matching valves see pages 630-634. For indirect heating systems only. Tappings are the width of the rail and approx. 52mm off the wall. Price includes radiator and wall fixing sets, valves extra.

Designer Range

Tunstall Towel Rails - Matt White

Size H x W	Watts	BTU	Element Output	Element Type	Code	£ Ex VAT	£ Inc VAT
560 x 1000mm	693	2365	300W	A, D or E	89.0025	152.00	182.40
800 x 500mm	451	1539	300W	A, D or E	89.0029	104.00	124.80
800 x 600mm	521	1778	300W	A, D or E	89.0041	116.00	139.20
1200 x 500mm	656	2238	300W	A, D or E	89.0033	160.00	192.00
1200 x 600mm	758	2586	300W	A, D or E	89.0045	175.00	210.00
1600 x 500mm	862	2941	300W	A, D or E	89.0037	196.00	235.20
1600 x 600mm	995	3395	600W	A, D or E	89.0049	223.00	267.60

Tunstall Towel Rails - Matt Anthracite

Size H x W	Watts	BTU	Element Output	Element Type	Code	£ Ex VAT	£ Inc VAT
560 x 1000mm	693	2365	300W	A, D or E	89.0026	152.00	182.40
800 x 500mm	451	1539	300W	A, D or E	89.0030	104.00	124.80
800 x 600mm	521	1778	300W	A, D or E	89.0042	116.00	139.20
1200 x 500mm	656	2238	300W	A, D or E	89.0034	160.00	192.00
1200 x 600mm	758	2586	300W	A, D or E	89.0046	175.00	210.00
1600 x 500mm	862	2941	300W	A, D or E	89.0038	196.00	235.20
1600 x 600mm	995	3395	600W	A, D or E	89.0050	223.00	267.60

Tunstall Towel Rails - Matt Black

Size H x W	Watts	BTU	Element Output	Element Type	Code	£ Ex VAT	£ Inc VAT
560 x 1000mm	693	2365	300W	A, D or E	89.0027	152.00	182.40
800 x 500mm	451	1539	300W	A, D or E	89.0031	104.00	124.80
800 x 600mm	521	1778	300W	A, D or E	89.0043	116.00	139.20
1200 x 500mm	656	2238	300W	A, D or E	89.0035	160.00	192.00
1200 x 600mm	758	2586	300W	A, D or E	89.0047	175.00	210.00
1600 x 500mm	862	2941	300W	A, D or E	89.0039	196.00	235.20
1600 x 600mm	995	3395	600W	A, D or E	89.0051	223.00	267.60

Tunstall Towel Rails - Chrome

Size H x W	Watts	BTU	Element Output	Element Type	Code	£ Ex VAT	£ Inc VAT
560 x 1000mm	466	1590	300W	A, D or E	89.0028	225.00	270.00
800 x 500mm	303	1034	150W	A, D or E	89.0032	193.00	231.60
800 x 600mm	350	1194	150W	A, D or E	89.0044	212.00	254.40
1200 x 500mm	442	1508	300W	A, D or E	89.0036	230.00	276.00
1200 x 600mm	511	1744	300W	A, D or E	89.0048	252.00	302.40
1600 x 500mm	580	1979	300W	A, D or E	89.0040	291.00	349.20
1600 x 600mm	670	2286	300W	A, D or E	89.0052	320.00	384.00

TECHNICAL INFORMATION

All measurements in Height by Width. Heat output based on $\Delta T60^{\circ}\text{C}$. Radiators that are electric only are restricted to the heat output of the elements. Element size can be increased to full capacity of rail if using element type D or E. For element types see pages 628-629. For matching valves see pages 630-634. For indirect heating systems only. Tappings are approx. 46mm less than the width of the rail and approx. 83mm off the wall. Price includes radiator and wall fixing sets, valves extra.

Robe Hooks
Page 636

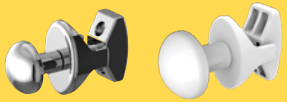

Round Vent Caps
Page 637



Warranty
5
Year

Heating

All Electric

Dual-Fuel

Pictured 89.0025
Matt White



560x1000mm size is the only horizontal Tunstall Towel Rail



Pictured 89.0048 Chrome

- FEATURES**
- Manufactured and tested to EN442 standard
 - 5 Year manufacturer's warranty*
 - CE and NF Certificates
 - Stunning chrome finish option available.
- * With conditions

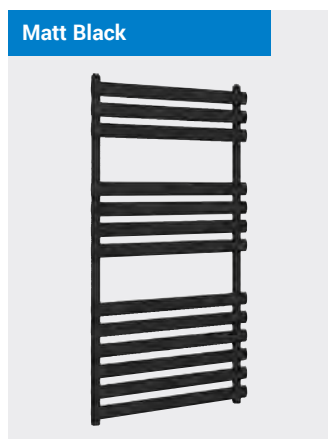
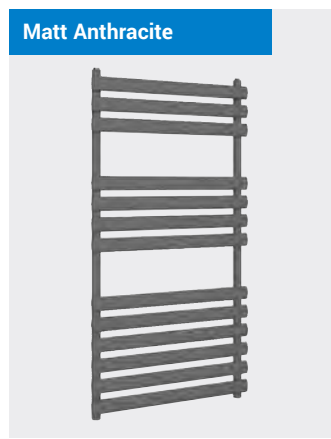

Designer Range

ADDINGTON TYPE10 - VERTICAL / HORIZONTAL

Towel Hangers
Page 554



Warranty
5
Year

Heating

All Electric

Dual-Fuel

Pictured 91.0015 Gloss White (Fitted Vertically) & 91.0081 x2 Towel Hangers

Designer Range

ADDINGTON TYPE10 - VERTICAL / HORIZONTAL

A designer radiator range available to fit both vertically and horizontally designs in gloss white and matt anthracite finishes. Optional extras include flat style and double flat style towel hangers (see Page 554).

FEATURES

- Manufactured and tested to EN442 standard.
- CE Certification.
- Single profile construction.
- Maximum corrosion resistance.
- Cataphoretic painting technology.
- Can be installed vertically or horizontally.
- Can be single, dual fuel or all electric (not all sizes).
- 5 Year Manufacturer's Warranty*

* With conditions

Addington Vertical / Horizontal Radiators - Gloss White

Size H x W	Watts	BTU	Element Output	Element Type	Code	£ Ex VAT	£ Inc VAT
500 x 514mm	414	1413	150W	A	91.0001	153.00	183.60
500 x 588mm	473	1614	150W	A	91.0002	167.00	200.40
600 x 514mm	492	1679	300W	A	91.0003	164.00	196.80
600 x 588mm	562	1918	300W	A	91.0004	179.00	214.80
800 x 514mm	642	2191	300W	A	91.0005	184.00	220.80
800 x 588mm	733	2501	300W	A	91.0006	153.00	242.40
1000 x 514mm	786	2682	300W	A	91.0007	204.00	244.80
1000 x 588mm	898	3064	300W	A	91.0008	225.00	270.00
1200 x 514mm	923	3149	300W	A	91.0009	225.00	270.00
1200 x 588mm	1055	3600	300W	A	91.0010	249.00	298.80
1400 x 514mm	1055	3600	300W	A	91.0011	245.00	294.00
1400 x 588mm	1206	4115	300W	A	91.0012	271.00	325.20
1800 x 292mm	744	2539	N/A	N/A	91.0013	188.00	225.60
1800 x 366mm	931	3177	N/A	N/A	91.0014	221.00	265.20
1800 x 440mm	1117	3811	300W	A	91.0015	253.00	303.60
1800 x 514mm	1303	4446	300W	A	91.0016	285.00	342.00
1800 x 588mm	1489	5080	300W	A	91.0017	318.00	381.60

Addington Vertical / Horizontal Radiators - Matt Anthracite

Size H x W	Watts	BTU	Element Output	Element Type	Code	£ Ex VAT	£ Inc VAT
500 x 514mm	414	1413	150W	A	91.0018	153.00	183.60
500 x 588mm	473	1614	150W	A	91.0019	167.00	200.40
600 x 514mm	492	1679	300W	A	91.0020	164.00	196.80
600 x 588mm	562	1918	300W	A	91.0021	179.00	214.80
800 x 514mm	642	2191	300W	A	91.0022	184.00	220.80
800 x 588mm	733	2501	300W	A	91.0023	202.00	242.40
1000 x 514mm	786	2682	300W	A	91.0024	204.00	244.80
1000 x 588mm	898	3064	300W	A	91.0025	225.00	270.00
1200 x 514mm	923	3149	300W	A	91.0026	225.00	270.00
1200 x 588mm	1055	3600	300W	A	91.0027	249.00	298.80
1400 x 514mm	1055	3600	300W	A	91.0028	245.00	294.00
1400 x 588mm	1206	4115	300W	A	91.0029	271.00	325.20
1800 x 292mm	744	2539	N/A	N/A	91.0030	188.00	225.60
1800 x 366mm	931	3177	N/A	N/A	91.0031	221.00	265.20
1800 x 440mm	1117	3811	300W	A	91.0032	253.00	303.60
1800 x 514mm	1303	4446	300W	A	91.0033	285.00	342.00
1800 x 588mm	1489	5080	300W	A	91.0034	318.00	381.60

TECHNICAL INFORMATION

All measurements in Height by Width. Heat output based on $\Delta T60^{\circ}\text{C}$. Radiators that are electric only are restricted to the heat output of the elements. For element types see pages 628-629. For matching valves see pages 630-634. Comes with pre-fitted flow diverter. Flow diverter must remain in place when radiator installed on central heating system (only for vertical installations). For indirect heating systems only. In vertical installation, tappings are the width of the rail and approx. 40mm off the wall. In horizontal installation, tappings are approx. 50mm less than the width of the rail and approx. 40mm off the wall. Price includes radiator and wall fixing sets, valves extra.



Pictured 91.0015 Gloss White (Fitted Horizontally)



Single profile construction

Radiator can be installed vertically or horizontally using the pre-fitted wall bracket holders. (Below images)



CREATE YOUR UNIQUE RADIATOR!

Bespoke RAL Colours

Our selection of 20 traditional and modern bespoke RAL colours allow you to inject your personal character into your radiator and help achieve that matching or statement piece look you were hoping for.

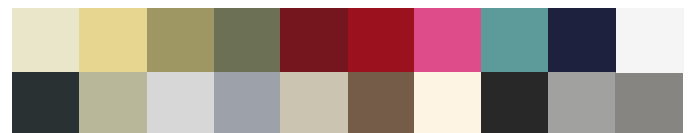

Bespoke Sizes

Our selection of bespoke sizes allows you to fit your radiator in tighter spaces, or even expand the size to produce a larger heat output.

Bespoke RAL Colours

Page 638



Bespoke Sizes

Page 639



Round Vent Caps

Page 637



Designer Range

ADDINGTON TYPE10 FLAT - TOWEL HANGERS

Double Flat



Pictured 91.0023 Matt Anthracite installed vertically with 91.0113

Single Flat



Pictured 91.0023 Matt Anthracite installed horizontally with 91.0084's



TECHNICAL DETAILS

The Double Flat Style Towel Hanger is compatible with **VERTICAL INSTALLATION ONLY**. **MUST BE FITTED BEFORE INSTALLATION!**

Radiators projection from wall 119mm when towel hangers is fitted.

Hanger Fitting Widths
148/222/296/370/444mm

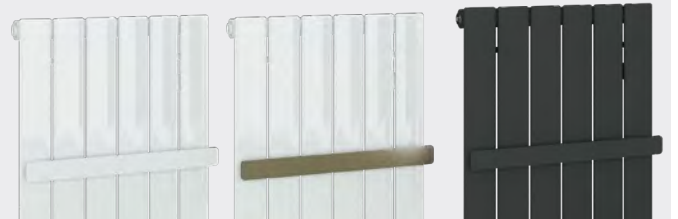

TECHNICAL DETAILS

The Flat Style Towel Hangers are compatible with vertical and horizontal installation. **MUST BE FITTED BEFORE INSTALLATION!**

Radiators projection from wall 119mm when towel hangers is fitted.

Hanger Fitting Widths
148/222/296/370/444mm



Addington Type10 - Double Flat Style Towel Hangers - Gloss White

Description	Code	£ Ex VAT	£ Inc VAT
Towel Hanger 292mm	91.0099	44.00	52.80
Towel Hanger 366mm	91.0100	46.00	55.20
Towel Hanger 440mm	91.0101	47.00	56.40
Towel Hanger 514mm	91.0102	48.00	57.60
Towel Hanger 588mm	91.0103	50.00	60.00

Addington Type10 - Double Flat Style Towel Hangers - Matt Anthracite

Size H x W	Code	£ Ex VAT	£ Inc VAT
Towel Hanger 292mm	91.0104	44.00	52.80
Towel Hanger 366mm	91.0105	46.00	55.20
Towel Hanger 440mm	91.0106	47.00	56.40
Towel Hanger 514mm	91.0107	48.00	57.60
Towel Hanger 588mm	91.0108	50.00	60.00

Addington Type10 - Double Flat Style Towel Hangers - Chrome

Size H x W	Code	£ Ex VAT	£ Inc VAT
Towel Hanger 292mm	91.0109	71.00	85.20
Towel Hanger 366mm	91.0110	73.00	87.60
Towel Hanger 440mm	91.0111	75.00	90.00
Towel Hanger 514mm	91.0112	77.00	92.40
Towel Hanger 588mm	91.0113	80.00	96.00

Addington Type10 - Single Flat Style Towel Hangers - Gloss White

Description	Code	£ Ex VAT	£ Inc VAT
Towel Hanger 292mm	91.0079	35.00	42.00
Towel Hanger 366mm	91.0080	36.00	43.20
Towel Hanger 440mm	91.0081	37.00	44.40
Towel Hanger 514mm	91.0082	38.00	45.60
Towel Hanger 588mm	91.0083	38.00	45.60

Addington Type10 - Single Flat Style Towel Hangers - Matt Anthracite

Size H x W	Code	£ Ex VAT	£ Inc VAT
Towel Hanger 292mm	91.0084	35.00	42.00
Towel Hanger 366mm	91.0085	36.00	43.20
Towel Hanger 440mm	91.0086	37.00	44.40
Towel Hanger 514mm	91.0087	38.00	45.60
Towel Hanger 588mm	91.0088	38.00	45.60

Addington Type10 - Single Flat Style Towel Hangers - Chrome

Size H x W	Code	£ Ex VAT	£ Inc VAT
Towel Hanger 292mm	91.0089	56.00	67.20
Towel Hanger 366mm	91.0090	57.00	68.40
Towel Hanger 440mm	91.0091	59.00	70.80
Towel Hanger 514mm	91.0092	60.00	72.00
Towel Hanger 588mm	91.0093	61.00	73.20

Designer Range

790mm High

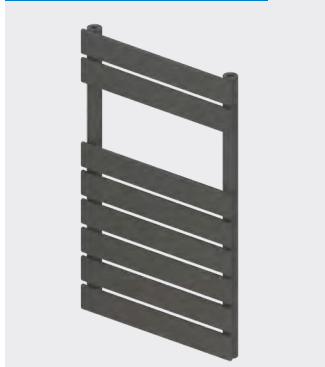

1750mm High

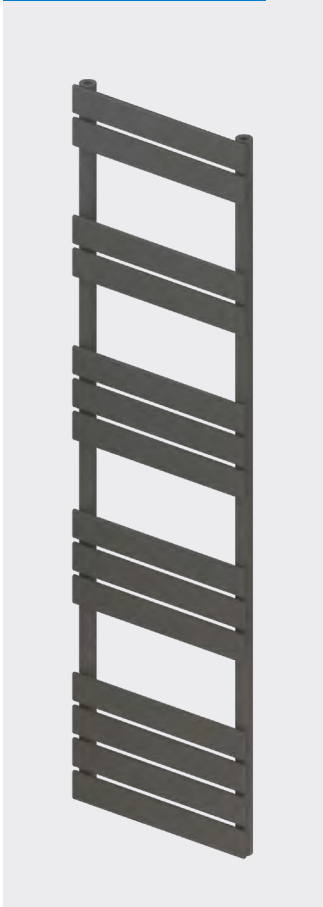

1110mm High

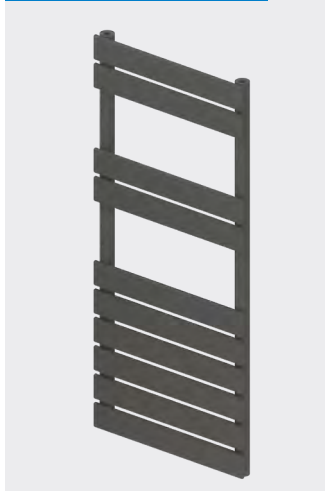

ADDINGTON TYPE10 - TOWEL RAILS



Pictured 91.0065 Gloss White

A designer towel rail available in 3 heights and 2 widths in gloss white, matt anthracite colours.

Addington Type10 Towel Rails - Gloss White

Size H x W	Watts	BTU	Element Output	Element Type	Code	£ Ex VAT	£ Inc VAT
790 x 400mm	374	1276	150W	A, D or E	91.0061	155.00	186.00
790 x 500mm	467	1593	300W	A, D or E	91.0064	178.00	213.60
790 x 600mm	560	1911	300W	A, D or E	91.0067	201.00	241.20
1110 x 400mm	492	1679	300W	A, D or E	91.0062	230.00	276.00
1110 x 500mm	610	2081	300W	A, D or E	91.0065	240.00	288.00
1110 x 600mm	731	2494	300W	A, D or E	91.0068	250.00	300.00
1750 x 400mm	729	2487	300W	A, D or E	91.0063	329.00	394.80
1750 x 500mm	885	3020	300W	A, D or E	91.0066	343.00	411.60
1750 x 600mm	1062	3624	600W	A, D or E	91.0069	357.00	428.40

Addington Type10 Towel Rails - Matt Anthracite

Size H x W	Watts	BTU	Element Output	Element Type	Code	£ Ex VAT	£ Inc VAT
790 x 400mm	374	1276	150W	A, D or E	91.0070	155.00	186.00
790 x 500mm	467	1593	300W	A, D or E	91.0073	178.00	213.60
790 x 600mm	560	1911	300W	A, D or E	91.0076	201.00	241.20
1110 x 400mm	492	1679	300W	A, D or E	91.0071	230.00	276.00
1110 x 500mm	610	2081	300W	A, D or E	91.0074	240.00	288.00
1110 x 600mm	731	2494	300W	A, D or E	91.0077	250.00	300.00
1750 x 400mm	729	2487	300W	A, D or E	91.0072	329.00	394.80
1750 x 500mm	885	3020	300W	A, D or E	91.0075	343.00	411.60
1750 x 600mm	1062	3624	600W	A, D or E	91.0078	357.00	428.40

Bespoke RAL Colours
Page 638

Round Vent Caps
Page 637

FEATURES

- Manufactured and tested to EN442 standard.
 - CE Certification.
 - Single profile construction.
 - Maximum corrosion resistance.
 - Cathophoretic painting technology.
 - Can be single, dual fuel or all electric.
 - 5 Year Manufacturer's Warranty*
- * With conditions

TECHNICAL INFORMATION

All measurements in Height by Width. Heat output based on $\Delta T60^{\circ}C$. Radiators that are electric only are restricted to the heat output of the elements. Element size can be increased to full capacity of rail if using element type D or E. For element types see pages 628-629. For matching valves see pages 630-634. For indirect heating systems only. Tappings are 50mm less than the width of the rail and approx. 40mm off the wall. Price includes radiator and wall fixing sets, valves extra.

Warranty

5

Year

Heating

All Electric

Dual-Fuel

Designer Range

ADDINGTON TYPE20 VERTICAL / HORIZONTAL



Radiator can be installed vertically or horizontally using the pre-fitted wall bracket holders. (Above images)



Double profile construction

A designer radiator range available to fit both vertically and horizontally designs in gloss white and matt anthracite finishes.

- FEATURES**
- Manufactured and tested to EN442 standard.
 - CE Certification.
 - Double profile construction.
 - Maximum corrosion resistance.
 - Cathaphoretic painting technology.
 - Can be installed vertically or horizontally.
 - Can be single, dual fuel or all electric.
 - 5 Year Manufacturer's Warranty*
- * With conditions

TECHNICAL INFORMATION

All measurements in Height by Width. Heat output based on $\Delta T60^{\circ}C$. Radiators that are electric only are restricted to the heat output of the elements. For element type see pages 628-629. For matching valves see pages 630-634. Flow diverter must remain in place when radiator installed on central heating system (only for vertical installations). For indirect heating systems only. In vertical installation, tappings are the width of the rail and approx. 64mm off the wall. In horizontal installation, tappings are approx. 50mm less than the width of the rail and approx. 64mm off the wall. Price includes radiator and wall fixing sets, valves extra.

Pictured 91.0042 Matt Anthracite (Fitted Vertically)

Designer Range

ADDINGTON TYPE20 VERTICAL / HORIZONTAL



Pictured 91.0042 Matt Anthracite (Fitted Horizontally)

Warranty

5

Year

Heating

All Electric

Dual-Fuel

Addington Type20 Vertical / Horizontal Radiators - Gloss White

Size H x W	Watts	BTU	Element Output	Element Type	Code	£ Ex VAT	£ Inc VAT
1800 x 366mm	1329	4535	150W	A	91.0035	378.00	453.60
1800 x 440mm	1595	5442	300W	A	91.0036	448.00	537.60
1800 x 514mm	1861	6350	300W	A	91.0037	518.00	621.60
1800 x 588mm	2127	7257	300W	A	91.0038	588.00	705.60

Addington Type20 Vertical / Horizontal Radiators - Matt Anthracite

Size H x W	Watts	BTU	Element Output	Element Type	Code	£ Ex VAT	£ Inc VAT
1800 x 366mm	1329	4535	150W	A	91.0039	378.00	453.60
1800 x 440mm	1595	5442	300W	A	91.0040	448.00	537.60
1800 x 514mm	1861	6350	300W	A	91.0041	518.00	621.60
1800 x 588mm	2127	7257	300W	A	91.0042	588.00	705.60

Bespoke RAL Colours
Page 638

Bespoke Sizes
Page 639

Round Vent Caps
Page 637



Designer Range

ADDINGTON TYPE21 - HORIZONTAL



A horizontal only designer radiator range with high heat outputs in gloss white and matt anthracite finishes.

Addington Type21 Horizontal Radiators - Gloss White							
Size H x W	Watts	BTU	Element Output	Element Type	Code	£ Ex VAT	£ Inc VAT
588 x 600mm	994	3392	300W	A	91.0043	319.00	382.80
588 x 800mm	1325	4521	300W	A	91.0044	388.00	465.60
588 x 1000mm	1694	5780	300W	A	91.0045	440.00	528.00
588 x 1200mm	1983	6766	300W	A	91.0046	522.00	626.40

Addington Type21 Horizontal Radiators - Matt Anthracite							
Size H x W	Watts	BTU	Element Output	Element Type	Code	£ Ex VAT	£ Inc VAT
588 x 600mm	994	3392	300W	A	91.0047	319.00	382.80
588 x 800mm	1325	4521	300W	A	91.0048	388.00	465.60
588 x 1000mm	1694	5780	300W	A	91.0049	440.00	528.00
588 x 1200mm	1983	6766	300W	A	91.0050	522.00	626.40

FEATURES

- Manufactured and tested to EN442 standard.
- CE Certification.
- Double profile construction with **one row of convector fins**
- Pre-fitted top grilles.
- Maximum corrosion resistance.
- Cataphoretic painting technology.
- Can only be installed horizontally.
- Can be single, dual fuel or all electric.
- 5 Year Manufacturer's Warranty*
* With conditions

TECHNICAL INFORMATION

All measurements in Height by Width. Heat output based on $\Delta T60^{\circ}\text{C}$. Radiators that are electric only are restricted to the heat output of the elements. For element type see pages 628-629. For matching valves see pages 630-634. For indirect heating systems only. Tappings are approx. 50mm less than the width of the rail and 75mm off the wall. Price includes radiator and wall fixing sets, valves extra.

Bespoke RAL Colours
Page 638



Bespoke Sizes
Page 639



Round Vent Caps
Page 637



Designer Range

ADDINGTON TYPE22 - HORIZONTAL



Addington Type22 Horizontal Radiators - Gloss White							
Size H x W	Watts	BTU	Element Output	Element Type	Code	£ Ex VAT	£ Inc VAT
292 x 1200mm	1703	5811	N/A	N/A	91.0055	309.00	370.80
588 x 600mm	1252	4272	300W	A	91.0051	339.00	406.80
588 x 800mm	1670	5698	300W	A	91.0052	413.00	495.60
588 x 1000mm	2099	7162	300W	A	91.0053	486.00	583.20
588 x 1200mm	2519	8595	300W	A	91.0054	558.00	669.60

Addington Type22 Horizontal Radiators - Matt Anthracite							
Size H x W	Watts	BTU	Element Output	Element Type	Code	£ Ex VAT	£ Inc VAT
292 x 1200mm	1703	5811	N/A	N/A	91.0060	309.00	370.80
588 x 600mm	1252	4272	300W	A	91.0056	339.00	406.80
588 x 800mm	1670	5698	300W	A	91.0057	413.00	495.60
588 x 1000mm	2099	7162	300W	A	91.0058	486.00	583.20
588 x 1200mm	2519	8595	300W	A	91.0059	558.00	669.60

FEATURES

- Manufactured and tested to EN442 standard.
- CE Certification.
- Double profile construction with **two rows of convector fins**
- Pre-fitted top grilles.
- Maximum corrosion resistance.
- Cathaphoretic painting technology.
- Can only be installed horizontally.
- Can be single, dual fuel or all electric.
- 5 Year Manufacturer's Warranty*
* With conditions

TECHNICAL INFORMATION

All measurements in Height by Width. Heat output based on $\Delta T60^{\circ}\text{C}$. Radiators that are electric only are restricted to the heat output of the elements. For element type see pages 628-629. For matching valves see pages 630-634. For indirect heating systems only. Tappings are approx. 50mm less than the width of the rail and 85mm off the wall. Price includes radiator and wall fixing sets, valves extra.

Bespoke RAL Colours

Page 638

Bespoke Sizes

Page 639

Round Vent Caps

Page 637

Designer Range

ADDINGTON TYPE20 - TOWEL RAILS



Double profile construction



1110mm High



1750mm High

A designer towel rail with high heat output, available in 2 heights in gloss white and matt anthracite colours.

FEATURES

- Manufactured and tested to EN442 standard.
 - CE Certification.
 - Double profile construction.
 - Maximum corrosion resistance.
 - Cataphoretic painting technology.
 - Can be single, dual fuel or all electric.
 - 5 Year Manufacturer's Warranty*
- * With conditions

TECHNICAL INFORMATION

All measurements in Height by Width. Heat output based on $\Delta T60^{\circ}\text{C}$. Radiators that are electric only are restricted to the heat output of the elements. Element size can be increased to full capacity of rail if using element type D or E. For element types see pages 628-629. For matching valves see pages 630-634. For indirect heating systems only. Tappings are 50mm less than the width of the rail and approx. 64mm off the wall. Price includes radiator and wall fixing sets, valves extra.

Addington Type20 Towel Rails - Gloss White

Size H x W	Watts	BTU	Element Output	Element Type	Code	£ Ex VAT	£ Inc VAT
1110 x 500mm	826	2817	300W	A, D or E	91.0119	355.00	426.00
1750 x 500mm	1163	3966	600W	A, D or E	91.0120	508.00	609.60

Addington Type20 Towel Rails - Matt Anthracite

Size H x W	Watts	BTU	Element Output	Element Type	Code	£ Ex VAT	£ Inc VAT
1110 x 500mm	826	2817	300W	A, D or E	91.0121	355.00	426.00
1750 x 500mm	1163	3966	600W	A, D or E	91.0122	508.00	609.60

Bespoke RAL Colours

Page 638



Round Vent Caps

Page 637



Designer Range

ADDINGTON TYPE21 - TOWEL RAILS

NEW



Warranty
5
Year

Heating

All Electric

Dual-Fuel



Double profile construction with one row of convectors fins



1110mm High



1750mm High

Pictured 91.0125 Matt Anthracite

A designer towel rail with high heat output, available in 2 heights in gloss white and matt anthracite colours.

FEATURES

- Manufactured and tested to EN442 standard.
 - CE Certification.
 - Double profile construction with **one row of convectors fins**
 - Maximum corrosion resistance.
 - Cataphoretic painting technology.
 - Can be single, dual fuel or all electric.
 - 5 Year Manufacturer's Warranty*
- *With conditions

TECHNICAL INFORMATION

All measurements in Height by Width. Heat output based on $\Delta T60^{\circ}C$. Radiators that are electric only are restricted to the heat output of the elements. Element size can be increased to full capacity of rail if using element type D or E. For element types see pages 628-629. For matching valves see pages 630-634. For indirect heating systems only. Tappings are 50mm less than the width of the rail and approx. 75mm off the wall. Price includes radiator and wall fixing sets, valves extra.

Addington Type21 Towel Rails - Gloss White								
Size H x W	Watts	BTU	Element Output	Element Type	Code	£ Ex VAT	£ Inc VAT	
1110 x 500mm	826	2817	300W	A, D or E	91.0123	418.00	501.60	
1750 x 500mm	1163	3966	600W	A, D or E	91.0124	590.00	708.00	

Addington Type21 Towel Rails - Matt Anthracite								
Size H x W	Watts	BTU	Element Output	Element Type	Code	£ Ex VAT	£ Inc VAT	
1110 x 500mm	826	2817	300W	A, D or E	91.0125	418.00	501.60	
1750 x 500mm	1163	3966	600W	A, D or E	91.0126	590.00	708.00	

Bespoke RAL Colours
Page 638



Round Vent Caps
Page 637



Designer Range



A statement piece which is also functional allowing many places for you to heat your towels. This designer radiator is laser cut & welded, only 7mm thick with a high heat output.

Claxton Designer Towel Rail - Matt White				WAS	NOW JUST	
Size H x W	Watts	BTU	Code	£ Ex VAT	£ Ex VAT	£ Inc VAT
866 x 500mm	467	1593	88.0001	303.00	202.00	242.40
866 x 600mm	543	1853	88.0004	349.00	233.00	279.60
1214 x 500mm	639	2180	88.0007	387.00	258.00	309.60
1214 x 600mm	740	2525	88.0010	439.00	293.00	351.60
1562 x 500mm	810	2764	88.0013	454.00	303.00	363.60
1562 x 600mm	936	3194	88.0016	516.00	344.00	412.80

ALL CLAXTON ITEMS ARE WHILE STOCKS LAST!

Claxton Designer Towel Rail - Matt Anthracite				WAS	NOW JUST	
Size H x W	Watts	BTU	Code	£ Ex VAT	£ Ex VAT	£ Inc VAT
866 x 600mm	543	1853	88.0006	356.00	238.00	285.60
1214 x 500mm	639	2180	88.0009	394.00	263.00	315.60
1214 x 600mm	740	2525	88.0012	449.00	300.00	360.00

ALL CLAXTON ITEMS ARE WHILE STOCKS LAST!

Claxton Designer Towel Rail - Matt Black				WAS	NOW JUST	
Size H x W	Watts	BTU	Code	£ Ex VAT	£ Ex VAT	£ Inc VAT
866 x 600mm	543	1853	88.0005	349.00	233.00	279.60
1562 x 600mm	936	3194	88.0016	516.00	344.00	412.80

ALL CLAXTON ITEMS ARE WHILE STOCKS LAST!

FEATURES

- High heat output
- Laser cut and laser welded construction
- Manufactured and tested to EN442 standard
- 5 Year manufacturer's warranty*
- Not suitable for elements
- Only 7mm thickness
- * With conditions

TECHNICAL INFORMATION

All measurements in Height by Width. Heat output based on $\Delta T60^{\circ}C$. For matching valves see pages 630-634. For indirect heating systems only. Tappings are approx. 50mm and approx. 33-63mm off the wall. Price includes radiator and wall fixing sets, valves extra.

Designer Range

WESTON



Pictured 88.0028 Matt White



Pictured 88.0036 Matt Anthracite

A simple designer radiator which has been laser cut and welded at only 7mm thick. Available in three matt finishes and with stylish chrome hangers as an optional extra.

Weston Designer Radiators - Matt White				WAS	NOW JUST	
Size H x W	Watts	BTU	Code	£ Ex VAT	£ Ex VAT	£ Inc VAT
1190 x 590mm	836	2853	88.0028	455.00	304.00	364.80

ALL WESTON ITEMS ARE WHILE STOCKS LAST!

Weston Designer Radiators - Matt Anthracite				WAS	NOW JUST	
Size H x W	Watts	BTU	Code	£ Ex VAT	£ Ex VAT	£ Inc VAT
790 x 490mm	461	1573	88.0021	290.00	194.00	232.80
790 x 590mm	455	1894	88.0024	344.00	230.00	276.00
1190 x 490mm	694	2368	88.0027	373.00	249.00	298.80
1190 x 590mm	836	2853	88.0030	465.00	310.00	372.00
1690 x 490mm	986	3364	88.0033	476.00	318.00	381.60
1690 x 590mm	1187	4050	88.0036	597.00	398.00	477.60

ALL WESTON ITEMS ARE WHILE STOCKS LAST!

Weston Designer Radiators - Matt Black				WAS	NOW JUST	
Size H x W	Watts	BTU	Code	£ Ex VAT	£ Ex VAT	£ Inc VAT
790 x 490mm	461	1573	88.0020	284.00	190.00	228.00
790 x 590mm	455	1894	88.0023	336.00	224.00	268.80
1190 x 490mm	694	2368	88.0026	366.00	244.00	292.80
1190 x 590mm	836	2853	88.0029	455.00	304.00	364.80
1690 x 590mm	1187	4050	88.0035	583.00	389.00	466.80

ALL WESTON ITEMS ARE WHILE STOCKS LAST!

FEATURES

- High heat output
- Laser cut and laser welded construction
- Manufactured and tested to EN442 standard
- 5 Year manufacturer's warranty*
- Not suitable for elements
- Only 7mm thickness
- * With conditions

TECHNICAL INFORMATION

All measurements in Height by Width. For matching valves see pages 630-634. For indirect heating systems only. Tappings are approx. 50mm and approx. 33-63mm off the wall. Price includes radiator and wall fixing sets, valves extra.

Aluminium Range

VELOR

High Output



Pictured 86.0163 Matt White



Slanted Horizontal Bars

The Velor features two towel rail widths of 500mm & 600mm, along with three height variations to suit any sized bathroom, kitchen or cloakroom suite.

Bespoke RAL Colours
Page 638



The Velor is light weight aluminium towel rail that has a high heat output. It's available in two colours; Matt White & Matt Anthracite, both with slanted horizontal bars.

Velor Straight Towel Rail - Matt White

Size H x W	Watts	BTU	Element Output	Element Type	Code	£ Ex VAT	£ Inc VAT
600 x 500mm	266	908	150W	A, D or E	86.0158	107.00	128.40
600 x 600mm	319	1090	150W	A, D or E	86.0159	117.00	140.40
1200 x 500mm	699	2384	300W	A, D or E	86.0160	215.00	258.00
1200 x 600mm	838	2861	300W	A, D or E	86.0161	238.00	285.60
1800 x 500mm	1031	3519	600W	A, D or E	86.0162	309.00	370.80
1800 x 600mm	1238	4223	600W	A, D or E	86.0163	347.00	416.40

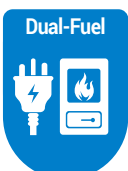

FEATURES

- Excellent heat conductivity and lightweight.
 - Only requires a low water volume.
 - Heats up very quickly.
 - Manufactured and tested to EN442 standard.
 - CE Certification.
 - 5 Year Manufacturer's Warranty*
 - Can be single or dual fuel, or all electric.
 - High heat output
- * With conditions

TECHNICAL INFORMATION

All measurements in Height by Width. Heat output based on $\Delta T60^{\circ}\text{C}$. Radiators that are electric only are restricted to the heat output of the elements. Element size can be increased to full capacity of rail if using element type D or E. For element types see pages 628-629. For matching valves see pages 630-634. For indirect heating systems only. Tappings are approx. 25mm less than the width of the rail and approx. 80-110mm off the wall. Price includes radiator and wall fixing sets, valves extra.

Aluminium Range

VELOR
High Output

Pictured 86.0167 Matt Anthracite

The Velor is light weight aluminium towel rail that has a high heat output. It's available in two colours; Matt White & Matt Anthracite, both with slanted horizontal bars.

Velor Straight Towel Rail - Matt Anthracite

Size H x W	Watts	BTU	Element Output	Element Type	Code	£ Ex VAT	£ Inc VAT
600 x 500mm	266	908	150W	A, D or E	86.0164	107.00	128.40
600 x 600mm	319	1090	150W	A, D or E	86.0165	117.00	140.40
1200 x 500mm	699	2384	300W	A, D or E	86.0166	215.00	258.00
1200 x 600mm	838	2861	300W	A, D or E	86.0167	238.00	285.60
1800 x 500mm	1031	3519	600W	A, D or E	86.0168	309.00	370.80
1800 x 600mm	1238	4223	600W	A, D or E	86.0169	347.00	416.40

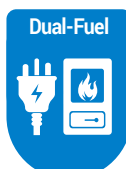

Slanted Horizontal Bars

The Velor features two towel rail widths of 500mm & 600mm, along with three height variations to suit any sized bathroom, kitchen or cloakroom suite.

Bespoke RAL Colours
Page 638

FEATURES

- Excellent heat conductivity and lightweight.
 - Only requires a low water volume.
 - Heats up very quickly.
 - Manufactured and tested to EN442 standard.
 - CE Certification.
 - 5 Year Manufacturer's Warranty*
 - Can be single or dual fuel, or all electric.
 - High heat output
- * With conditions

TECHNICAL INFORMATION

All measurements in Height by Width. Heat output based on $\Delta T60^{\circ}\text{C}$. Radiators that are electric only are restricted to the heat output of the elements. Element size can be increased to full capacity of rail if using element type D or E. For element types see pages 628-629. For matching valves see pages 630-634. For indirect heating systems only. Tappings are approx. 25mm less than the width of the rail and approx. 80-110mm off the wall. Price includes radiator and wall fixing sets, valves extra.

Aluminium Range

ROSANO VERTICAL



Warranty
5
Year

Heating

All Electric

Dual-Fuel

Pictured 86.0004 Matt White with 101.0052 Towel Hangers x1 & 86.0112 Cover Caps x2

A luxurious flat panelled radiator range with stunning clean lines which will be the focus of any room. Available in a choice of colours and in horizontal or vertical designs. Stunning towel hangers will complement the vertical design allowing room for your towels.

TECHNICAL INFORMATION

All measurements in Height by Width. Heat output based on $\Delta T60^{\circ}\text{C}$. For matching valves see pages 630-634. Corrosion inhibitor must be added to the heating system and maintained. Flow diverter must only be fitted when radiator installed on central heating system. For indirect heating systems only. Tappings are the width of the rail and 35 or 55mm off the wall.

Aluminium Range



Rosano Vertical Aluminium Radiators - Matt White

Size H x W	Watts	BTU	Element Output	Element Type	Code	£ Ex VAT	£ Inc VAT
600 x 280mm	316	1078	150W	A	86.0147	120.00	144.00
1800 x 280mm	948	3235	600W	A	86.0001	195.00	234.00
1800 x 375mm	1264	4313	600W	A	86.0004	250.00	300.00
1800 x 470mm	1580	5391	900W	A	86.0007	305.00	366.00

Rosano Vertical Aluminium Radiators - Matt Anthracite

Size H x W	Watts	BTU	Element Output	Element Type	Code	£ Ex VAT	£ Inc VAT
600 x 280mm	316	1078	150W	A	86.0148	120.00	144.00
1800 x 280mm	948	3235	600W	A	86.0002	195.00	234.00
1800 x 375mm	1264	4313	600W	A	86.0005	250.00	300.00
1800 x 470mm	1580	5391	900W	A	86.0008	305.00	366.00

Rosano Vertical Aluminium Radiators - Matt Black

Size H x W	Watts	BTU	Element Output	Element Type	Code	£ Ex VAT	£ Inc VAT
600 x 280mm	316	1078	150W	A	86.0149	120.00	144.00
1800 x 280mm	948	3235	600W	A	86.0003	195.00	234.00
1800 x 375mm	1264	4313	600W	A	86.0006	250.00	300.00
1800 x 470mm	1580	5391	900W	A	86.0009	305.00	366.00

Prices include radiator and wall fixing sets, valves and accessories extra.

FEATURES

- Excellent heat conductivity and lightweight.
- Only requires a low water volume.
- Heats up very quickly.
- Manufactured and tested to EN442 standard.
- CE Certification.
- 5 Year Manufacturer's Warranty*
- Can be single or dual fuel, or all electric.
- Radiators come with cover caps on top and bottom, the same colour as the radiator.

* With conditions

For element types see pages 628-629.

Element can be installed vertically on the right-hand side or left-hand side on the bottom header. Radiators that are electric only are restricted to the heat output of the elements.



ROSANO VERTICAL

Pictured 86.0005 Matt Anthracite with 86.0026 Towel Hangers



For all Rosano Matt White, Matt Anthracite, Matt Black, Chrome and Premium Towel Hangers, please refer to page 570-571.



Rosano Cover Cap Sets - Chrome

Description	Code	£ Ex VAT	£ Inc VAT
Cover Cap Set 280mm	86.0111	13.00	15.60
Cover Cap Set 375mm	86.0112	16.00	19.20
Cover Cap Set 470mm	86.0113	18.00	21.60

Cover cap sets only include cover caps for the top of the radiator.

Bespoke RAL Colours
Page 638



Bespoke Sizes
Page 639



Aluminium Range

ROSANO HORIZONTAL

Pictured 86.0020 Matt Anthracite

Pictured 86.0021 Matt Black





- Warranty

5

Year
- Heating

- All Electric

- Dual-Fuel



A luxurious flat panelled radiator range with stunning clean lines which will be the focus of any room. Available in a choice of colours and in horizontal or vertical designs.

TECHNICAL INFORMATION

All measurements in Height by Width. Heat output based on $\Delta T60^{\circ}\text{C}$. For matching valves see pages 630-634. Corrosion inhibitor must be added to the heating system and maintained. Flow diverter must only be fitted when radiator installed on central heating system. For indirect heating systems only. Tappings are the width of the rail and 35 or 55mm off the wall.

Bespoke RAL Colours
Page 638



Bespoke Sizes
Page 639



Aluminium Range

ROSANO HORIZONTAL

Pictured 86.0016 Matt White with 89.0373 Towel Hanger



Rosano Horizontal Aluminium Radiators - Matt White

Size H x W	Watts	BTU	Element Output	Element Type	Code	£ Ex VAT	£ Inc VAT
600 x 470mm	555	1894	300W	A or C	86.0010	156.00	187.20
600 x 660mm	777	2651	300W	A or C	86.0013	206.00	247.20
600 x 850mm	999	3409	600W	A or C	86.0016	257.00	308.40
600 x 1040mm	1221	4166	600W	A or C	86.0019	307.00	368.40
600 x 1230mm	1443	4924	900W	A or C	86.0022	357.00	428.40

Rosano Horizontal Aluminium Radiators - Matt Anthracite

Size H x W	Watts	BTU	Element Output	Element Type	Code	£ Ex VAT	£ Inc VAT
600 x 470mm	555	1894	300W	A or C	86.0011	156.00	187.20
600 x 660mm	777	2651	300W	A or C	86.0014	206.00	247.20
600 x 850mm	999	3409	600W	A or C	86.0017	257.00	308.40
600 x 1040mm	1221	4166	600W	A or C	86.0020	307.00	368.40
600 x 1230mm	1443	4924	900W	A or C	86.0023	357.00	428.40

Rosano Horizontal Aluminium Radiators - Matt Black

Size H x W	Watts	BTU	Element Output	Element Type	Code	£ Ex VAT	£ Inc VAT
600 x 470mm	555	1894	300W	A or C	86.0012	156.00	187.20
600 x 660mm	777	2651	300W	A or C	86.0015	206.00	247.20
600 x 850mm	999	3409	600W	A or C	86.0018	257.00	308.40
600 x 1040mm	1221	4166	600W	A or C	86.0021	307.00	368.40
600 x 1230mm	1443	4924	900W	A or C	86.0024	357.00	428.40

Prices include radiator and wall fixing sets, valves and accessories extra.

FEATURES

- Excellent heat conductivity and lightweight.
- Only requires a low water volume.
- Heats up very quickly.
- Manufactured and tested to EN442 standard.
- CE Certification.
- 5 Year Manufacturer's Warranty*
- Can be single or dual fuel, or all electric.
- Radiators come with cover caps on top and bottom, the same colour as the radiator.

* With conditions

For element types see pages 628-629.

Element can be installed vertically on the right-hand side or left-hand side on the bottom header. Radiators that are electric only are restricted to the heat output of the elements (Type C up to 900 watts).



Matt White



Matt Anthracite

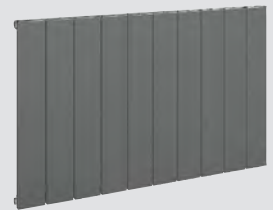

Matt Black



For all Rosano Matt White, Matt Anthracite, Matt Black, Chrome and Premium Towel Hangers, please refer to page 570-571.



Rosano Cover Cap Sets - Chrome

Description	Code	£ Ex VAT	£ Inc VAT
Cover Cap Set 470mm	86.0113	18.00	21.60
Cover Cap Set 660mm	86.0114	25.00	30.00
Cover Cap Set 850mm	86.0115	31.00	37.20
Cover Cap Set 1040mm	86.0116	38.00	45.60
Cover Cap Set 1230mm	86.0117	43.00	51.60

Cover cap sets only include cover caps for the top of the radiator.

Aluminium Range

ROSANO STANDARD TOWEL HANGERS



Towel Hanger - Matt White			
Size	Code	£ Ex VAT	£ Inc VAT
280mm	89.0177	34.00	40.80
375mm	89.0178	37.00	44.40
470mm	89.0179	42.00	50.40



Towel Hanger - Matt Anthracite			
Size	Code	£ Ex VAT	£ Inc VAT
280mm	89.0180	34.00	40.80
375mm	89.0181	37.00	44.40
470mm	89.0182	42.00	50.40



Towel Hanger - Matt Black			
Size	Code	£ Ex VAT	£ Inc VAT
280mm	89.0183	32.00	38.40
375mm	89.0184	35.00	42.00
470mm	89.0185	40.00	48.00



Towel Hanger - Chrome			
Size	Code	£ Ex VAT	£ Inc VAT
280mm	86.0025	31.00	37.20
375mm	86.0026	36.00	43.20
470mm	86.0027	40.00	48.00

TECHNICAL INFORMATION

Material: Steel (Premium: Stainless Steel - Grade 304)

Vertical Radiators:

1800mm height radiators comes with 3 pre-drilled towel hanger locations, with a maximum of 3 towel hangers - all widths; 280, 375 and 470mm. 600mm height radiators comes with 1 pre-drilled towel hanger location, with a maximum of 1 towel hanger - 280mm width. The standard towel hangers are only compatible with the Vertical Radiators.

Can be fitted after installation!

Horizontal Radiators:

Don't have holes for Standard Towel Hangers. Standard Towel Hanger can not be fitted. The Rosano Standard Towel Hangers will add approx 8mm width on each side once fitted to the radiator.



Towel Hanger - Mirror Polished Premium			
Size	Code	£ Ex VAT	£ Inc VAT
280mm	86.0198	43.00	51.60
375mm	89.0199	39.00	46.80
470mm	86.0200	52.00	62.40

ROSANO FLAT STYLE TOWEL HANGERS

SINGLE FLAT STYLE



Towel Hanger - Matt White			
Size	Code	£ Ex VAT	£ Inc VAT
280mm	89.0283	40.00	48.00
375mm	89.0284	45.00	54.00
470mm	89.0285	51.00	61.20
660mm	89.0286	58.00	69.60
850mm	89.0287	65.00	78.00



Towel Hanger - Matt Anthracite			
Size	Code	£ Ex VAT	£ Inc VAT
280mm	89.0288	40.00	48.00
375mm	89.0289	45.00	54.00
470mm	89.0290	51.00	61.20
660mm	89.0291	58.00	69.60
850mm	89.0292	65.00	78.00



Towel Hanger - Matt Black			
Size	Code	£ Ex VAT	£ Inc VAT
280mm	89.0293	40.00	48.00
375mm	89.0294	45.00	54.00
470mm	89.0295	51.00	61.20
660mm	89.0296	58.00	69.60
850mm	89.0297	65.00	78.00



Towel Hanger - Chrome			
Size	Code	£ Ex VAT	£ Inc VAT
280mm	91.0094	56.00	67.20
375mm	91.0095	57.00	68.40
470mm	91.0096	59.00	70.80
660mm	91.0097	62.00	74.40
850mm	91.0098	66.00	79.20

DOUBLE FLAT STYLE



Towel Hanger - Matt White			
Size	Code	£ Ex VAT	£ Inc VAT
280mm	89.0369	50.00	60.00
375mm	89.0370	54.00	64.80
470mm	89.0371	61.00	73.20
660mm	89.0372	70.00	84.00
850mm	89.0373	78.00	93.60



Towel Hanger - Matt Anthracite			
Size	Code	£ Ex VAT	£ Inc VAT
280mm	89.0374	50.00	60.00
375mm	89.0375	54.00	64.80
470mm	89.0376	61.00	73.20
660mm	89.0377	70.00	84.00
850mm	89.0378	78.00	93.60



Towel Hanger - Matt Black			
Size	Code	£ Ex VAT	£ Inc VAT
280mm	89.0379	50.00	60.00
375mm	89.0380	54.00	64.80
470mm	89.0381	61.00	73.20
660mm	89.0382	70.00	84.00
850mm	89.0383	78.00	93.60



Towel Hanger - Chrome			
Size	Code	£ Ex VAT	£ Inc VAT
280mm	91.0114	71.00	85.20
375mm	91.0115	73.00	87.60
470mm	91.0116	75.00	90.00
660mm	91.0117	82.00	98.40
850mm	91.0118	89.00	106.80

TECHNICAL INFORMATION

Material: Steel

Vertical and Horizontal Radiators:

Flat & Double Flat Style Hangers are compatible with both Vertical and Horizontal radiators. (Depending on the radiators and hangers width)

Must be fitted before installation!

Hanger Fitting Widths
96/191/286/476/666mm



Hanger Fitting Widths
96/191/286/476/666mm

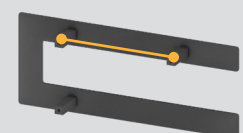

Aluminium Range

ROSANO FLAT TRIPLE TOWEL HANGER



Flat Triple Hanger - Brushed Stainless Steel

Size	Code	£ Ex VAT	£ Inc VAT
280mm	101.0048	142.00	170.40
375mm	101.0049	156.00	187.20
470mm	101.0050	178.00	213.60

Flat Triple Hanger - Polished Stainless Steel

Size	Code	£ Ex VAT	£ Inc VAT
280mm	101.0054	142.00	170.40
375mm	101.0055	156.00	187.20
470mm	101.0056	178.00	213.60

ROSANO CURVED TRIPLE TOWEL HANGER



Flat Triple Hanger - Brushed Stainless Steel

Size	Code	£ Ex VAT	£ Inc VAT
280mm	101.0051	142.00	170.40
375mm	101.0052	156.00	187.20
470mm	101.0053	178.00	213.60

Flat Triple Hanger - Polished Stainless Steel

Size	Code	£ Ex VAT	£ Inc VAT
280mm	101.0057	142.00	170.40
375mm	101.0058	156.00	187.20
470mm	101.0059	178.00	213.60

TECHNICAL INFORMATION

Material: **Stainless Steel - Grade 304**

Vertical Radiators:

1800mm height radiators comes with 3 pre-drilled towel hanger locations. 600mm height radiators come with 1 pre-drilled towel hanger location. The flat triple & curved triple towel hangers are only compatible with the Vertical Radiators and can be fitted to the pre-drilled holes on 1800mm & 600mm height radiators.

Can be fitted after installation!

Horizontal Radiators:

The flat triple & curved triple towel hangers are not suitable for horizontal radiators.

ROSANO - FLAT TOWEL SHELF



Flat Towel Shelves - Matt White

Size	Code	£ Ex VAT	£ Inc VAT
280mm	89.0459	34.00	40.80
375mm	89.0460	37.00	44.40
470mm	89.0461	41.00	49.20

Towel Shelves - Matt Anthracite

Size	Code	£ Ex VAT	£ Inc VAT
280mm	89.0462	34.00	40.80
375mm	89.0463	37.00	44.40
470mm	89.0464	41.00	49.20

Towel Shelves - Matt Black

Size	Code	£ Ex VAT	£ Inc VAT
280mm	89.0465	34.00	40.80
375mm	89.0466	37.00	44.40
470mm	89.0467	41.00	49.20

ROSANO - DESIGNER TOWEL SHELF



Designer Towel Shelves - Matt White

Size	Code	£ Ex VAT	£ Inc VAT
280mm	89.0441	62.00	74.40
375mm	89.0442	65.00	78.00
470mm	89.0443	69.00	82.80

Designer Towel Shelves - Matt Anthracite

Size	Code	£ Ex VAT	£ Inc VAT
280mm	89.0444	62.00	74.40
375mm	89.0445	65.00	78.00
470mm	89.0446	69.00	82.80

Designer Towel Shelves - Matt Black

Size	Code	£ Ex VAT	£ Inc VAT
280mm	89.0447	62.00	74.40
375mm	89.0448	65.00	78.00
470mm	89.0449	69.00	82.80

TECHNICAL INFORMATION

Material: **Steel**

Flat & Designer Towel Shelves are compatible with both Vertical and Horizontal radiators.

(Depending on the radiators and hangers width) * Compatible with Peretti Horizontal Radiators.

Must be fitted before installation!

Aluminium Range

PERETTI VERTICAL



Pictured 86.0178 Polished Aluminium with 86.0078 Towel Hangers



Pictured 86.0058 Matt Black with 86.0078 Towel Hangers



A refined version of the designer flat panelled radiators with a curve to the end two panels. This radiator will add a touch of sophistication creating an impact in any room. Available in both vertical and horizontal designs as well as four different colours for maximum choice. Stunning towel hangers will complement the vertical design allowing room for your towels.

TECHNICAL INFORMATION

All measurements in Height by Width. Heat output based on $\Delta T60^{\circ}\text{C}$. For matching valves see pages 630-634. Corrosion inhibitor must be added to the heating system and maintained. Flow diverter must only be fitted when radiator installed on central heating system. For indirect heating systems only. Tappings are the width of the rail and 35 or 55mm off the wall.

FEATURES

- Excellent heat conductivity and lightweight.
 - Only requires a low water volume.
 - Heats up very quickly.
 - Radiators come with cover caps on top and bottom, same as radiator colour.
 - Manufactured and tested to EN442 standard.
 - CE Certification.
 - 5 Year Manufacturer's Warranty*
 - Can be single or dual fuel, or all electric.
- * With conditions

<p>Warranty</p> <p>5</p> <p>Year</p>	<p>Heating</p> 	<p>All Electric</p> 	<p>Dual-Fuel</p> 
---	--	---	--

For Towel Hangers and Shelves Options See pages 576-577.



Aluminium Range

PERETTI VERTICAL



Peretti Vertical Aluminium Radiators - Matt White

Size H x W	Watts	BTU	Element Output	Element Type	Code	£ Ex VAT	£ Inc VAT
600 x 280mm	316	1078	150W	A	86.0150	120.00	144.00
1800 x 280mm	948	3235	600W	A	86.0053	195.00	234.00
1800 x 375mm	1264	4313	600W	A	86.0056	250.00	300.00
1800 x 470mm	1580	5391	900W	A	86.0059	305.00	366.00

Peretti Vertical Aluminium Radiators - Matt Anthracite

Size H x W	Watts	BTU	Element Output	Element Type	Code	£ Ex VAT	£ Inc VAT
600 x 280mm	316	1078	150W	A	86.0151	120.00	144.00
1800 x 280mm	948	3235	600W	A	86.0054	195.00	234.00
1800 x 375mm	1264	4313	600W	A	86.0057	250.00	300.00
1800 x 470mm	1580	5391	900W	A	86.0060	305.00	366.00

Peretti Vertical Aluminium Radiators - Matt Black

Size H x W	Watts	BTU	Element Output	Element Type	Code	£ Ex VAT	£ Inc VAT
600 x 280mm	316	1078	150W	A	86.0152	120.00	144.00
1800 x 280mm	948	3235	600W	A	86.0055	195.00	234.00
1800 x 375mm	1264	4313	600W	A	86.0058	250.00	300.00
1800 x 470mm	1580	5391	900W	A	86.0061	305.00	366.00

Peretti Vertical Aluminium Radiators - Polished

Size H x W	Watts	BTU	Element Output	Element Type	Code	£ Ex VAT	£ Inc VAT
600 x 280mm	307	1046	150W	A	86.0176	131.00	157.20
1800 x 280mm	920	3138	600W	A	86.0177	229.00	274.80
1800 x 375mm	1226	4184	600W	A	86.0178	295.00	354.00
1800 x 470mm	1533	5229	900W	A	86.0179	360.00	432.00

Prices include radiator and wall fixing sets, valves and accessories extra.



Peretti Cover Cap Sets - Chrome

Description	Code	£ Ex VAT	£ Inc VAT
Cover Cap Set 280mm	86.0125	13.00	15.60
Cover Cap Set 375mm	86.0126	16.00	19.20
Cover Cap Set 470mm	86.0113	18.00	21.60

Cover cap sets only include cover caps for the top of the radiator.

For element types see pages 628-629.

Element can be installed vertically on the right-hand side or left-hand side on the bottom header. Radiators that are electric only are restricted to the heat output of the elements.



Bespoke RAL Colours
Page 638



Bespoke Sizes
Page 639



Aluminium Range

PERETTI HORIZONTAL

Pictured 86.0183 Polished Aluminium with 91.0117 Towel Hanger



- Warranty

5

Year
- Heating
- All Electric
- Dual-Fuel

A refined version of the designer flat panelled radiators with a curve to the end two panels. This radiator will add a touch of sophistication creating an impact in any room. Available in both vertical and horizontal designs as well as four different colours for maximum choice. Stunning towel hangers will complement the vertical design allowing room for your towels.

FEATURES

- Excellent heat conductivity and lightweight.
 - Only requires a low water volume.
 - Heats up very quickly.
 - Radiators come with cover caps on top and bottom, same as radiator colour.
 - Manufactured and tested to EN442 standard.
 - CE Certification.
 - 5 Year Manufacturer's Warranty*
 - Can be single or dual fuel, or all electric.
- * With conditions

TECHNICAL INFORMATION

All measurements in Height by Width. Heat output based on $\Delta T60^{\circ}\text{C}$. For matching valves see pages 630-634. Corrosion inhibitor must be added to the heating system and maintained. Flow diverter must only be fitted when radiator installed on central heating system. For indirect heating systems only. Tappings are the width of the rail and 35 or 55mm off the wall.

For Towel Hangers and Shelves Options See pages 576-577.



Bespoke RAL Colours
Page 638



Bespoke Sizes
Page 639

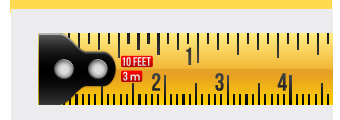

Aluminium Range

PERETTI HORIZONTAL

Pictured 86.0069 Matt Anthracite with 89.0290 Towel Hanger



Peretti Horizontal Aluminium Radiators - Matt White

Size H x W	Watts	BTU	Element Output	Element Type	Code	£ Ex VAT	£ Inc VAT
600 x 470mm	555	1894	300W	A or C	86.0062	156.00	187.20
600 x 660mm	777	2651	300W	A or C	86.0065	206.00	247.20
600 x 850mm	999	3409	600W	A or C	86.0068	257.00	308.40
600 x 1040mm	1221	4166	600W	A or C	86.0071	307.00	368.40
600 x 1230mm	1443	4924	900W	A or C	86.0074	358.00	429.60

Peretti Horizontal Aluminium Radiators - Matt Anthracite

Size H x W	Watts	BTU	Element Output	Element Type	Code	£ Ex VAT	£ Inc VAT
600 x 470mm	555	1894	300W	A or C	86.0063	156.00	187.20
600 x 660mm	777	2651	300W	A or C	86.0066	206.00	247.20
600 x 850mm	999	3409	600W	A or C	86.0069	257.00	308.40
600 x 1040mm	1221	4166	600W	A or C	86.0072	307.00	368.40
600 x 1230mm	1443	4924	900W	A or C	86.0075	358.00	429.60

Peretti Horizontal Aluminium Radiators - Matt Black

Size H x W	Watts	BTU	Element Output	Element Type	Code	£ Ex VAT	£ Inc VAT
600 x 470mm	555	1894	300W	A or C	86.0064	156.00	187.20
600 x 660mm	777	2651	300W	A or C	86.0067	206.00	247.20
600 x 850mm	999	3409	600W	A or C	86.0070	257.00	308.40
600 x 1040mm	1221	4166	600W	A or C	86.0073	307.00	368.40
600 x 1230mm	1443	4924	900W	A or C	86.0076	358.00	429.60

Peretti Horizontal Aluminium Radiators - Polished Aluminium

Size H x W	Watts	BTU	Element Output	Element Type	Code	£ Ex VAT	£ Inc VAT
600 x 470mm	538	1837	300W	A or C	86.0180	184.00	220.80
600 x 660mm	754	2571	300W	A or C	86.0181	244.00	292.80
600 x 850mm	969	3307	600W	A or C	86.0182	302.00	362.40
600 x 1040mm	1184	4041	600W	A or C	86.0183	362.00	434.40
600 x 1230mm	1400	4776	900W	A or C	86.0184	422.00	506.40

For element types see pages 628-629.

Element can be installed vertically on the right-hand side or left-hand side on the bottom header. Radiators that are electric only are restricted to the heat output of the elements (Type C up to 900 watts).

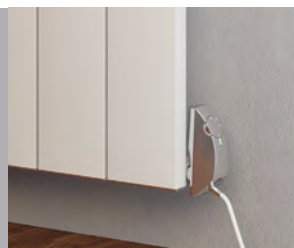

Matt White



Matt Anthracite

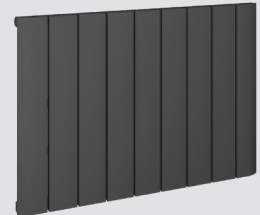

Matt Black

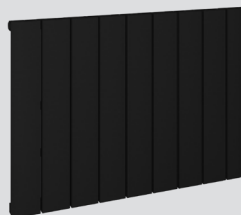

Polished Aluminium

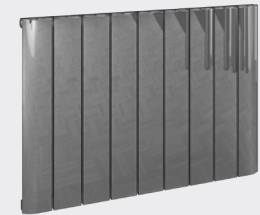

Peretti Cover Cap Sets - Chrome

Description	Code	£ Ex VAT	£ Inc VAT
Cover Cap Set 470mm	86.0127	18.00	21.60
Cover Cap Set 660mm	86.0128	25.00	30.00
Cover Cap Set 850mm	86.0129	31.00	37.20
Cover Cap Set 1040mm	86.0130	38.00	45.60
Cover Cap Set 1230mm	86.0131	43.00	51.60

Cover cap sets only include cover caps for the top of the radiator.

Aluminium Range

PERETTI STANDARD TOWEL HANGERS



Towel Hanger - Matt White			
Size	Code	£ Ex VAT	£ Inc VAT
280mm	89.0186	34.00	40.80
375mm	89.0187	37.00	44.40
470mm	89.0188	42.00	50.40



Towel Hanger - Matt Anthracite			
Size	Code	£ Ex VAT	£ Inc VAT
280mm	89.0189	34.00	40.80
375mm	89.0190	37.00	44.40
470mm	89.0191	42.00	50.40



Towel Hanger - Matt Black			
Size	Code	£ Ex VAT	£ Inc VAT
280mm	89.0192	34.00	40.80
375mm	89.0193	37.00	44.40
470mm	89.0194	42.00	50.40



Towel Hanger - Chrome			
Size	Code	£ Ex VAT	£ Inc VAT
280mm	86.0077	31.00	37.20
375mm	86.0078	36.00	43.20
470mm	86.0079	40.00	48.00

TECHNICAL INFORMATION

Material: Steel (Premium: Stainless Steel - Grade 304)

Vertical Radiators:

1800mm height radiators comes with 3 pre-drilled towel hanger locations, with a maximum of 3 towel hangers - (all widths; 280, 375 and 470mm). 600mm height radiators comes with 1 pre-drilled towel hanger location, with a maximum of 1 towel hanger - (280mm width). The Standard Towel Hangers are only compatible with the Vertical Radiators.

Horizontal Radiators:

Don't have holes for Standard Towel Hangers. Standard Towel Hanger can not be fitted. The Peretti Standard Towel Hangers will add approx 8mm width on each side once fitted to the radiator.

Can be fitted after installation!



Towel Hanger - Mirror Polished Premium			
Size	Code	£ Ex VAT	£ Inc VAT
280mm	86.0201	43.00	51.60
375mm	86.0202	47.00	56.40
470mm	86.0203	52.00	62.40

PERETTI FLAT STYLE TOWEL HANGERS

SINGLE FLAT STYLE



Towel Hanger - Matt White			
Size	Code	£ Ex VAT	£ Inc VAT
280mm	89.0283	40.00	48.00
375mm	89.0284	45.00	54.00
470mm	89.0285	51.00	61.20
660mm	89.0286	58.00	69.60
850mm	89.0287	65.00	78.00

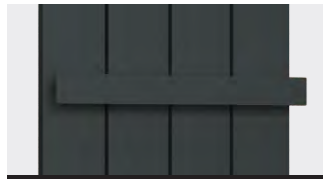

Towel Hanger - Matt Anthracite			
Size	Code	£ Ex VAT	£ Inc VAT
280mm	89.0288	40.00	48.00
375mm	89.0289	45.00	54.00
470mm	89.0290	51.00	61.20
660mm	89.0291	58.00	69.60
850mm	89.0292	65.00	78.00

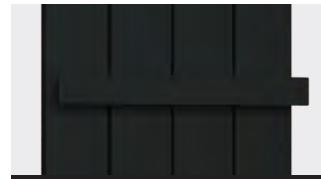

Towel Hanger - Matt Black			
Size	Code	£ Ex VAT	£ Inc VAT
280mm	89.0293	40.00	48.00
375mm	89.0294	45.00	54.00
470mm	89.0295	51.00	61.20
660mm	89.0296	58.00	69.60
850mm	89.0297	65.00	78.00



Towel Hanger - Chrome			
Size	Code	£ Ex VAT	£ Inc VAT
280mm	91.0094	56.00	67.20
375mm	91.0095	57.00	68.40
470mm	91.0096	59.00	70.80
660mm	91.0097	62.00	74.40
850mm	91.0098	66.00	79.20

DOUBLE FLAT STYLE



Towel Hanger - Matt White			
Size	Code	£ Ex VAT	£ Inc VAT
280mm	89.0369	50.00	60.00
375mm	89.0370	54.00	64.80
470mm	89.0371	61.00	73.20
660mm	89.0372	70.00	84.00
850mm	89.0373	78.00	93.60



Towel Hanger - Matt Anthracite			
Size	Code	£ Ex VAT	£ Inc VAT
280mm	89.0374	50.00	60.00
375mm	89.0375	54.00	64.80
470mm	89.0376	61.00	73.20
660mm	89.0377	70.00	84.00
850mm	89.0378	78.00	93.60



Towel Hanger - Matt Black			
Size	Code	£ Ex VAT	£ Inc VAT
280mm	89.0379	50.00	60.00
375mm	89.0380	54.00	64.80
470mm	89.0381	61.00	73.20
660mm	89.0382	70.00	84.00
850mm	89.0383	78.00	93.60



Towel Hanger - Chrome			
Size	Code	£ Ex VAT	£ Inc VAT
280mm	91.0114	71.00	85.20
375mm	91.0115	73.00	87.60
470mm	91.0116	75.00	90.00
660mm	91.0117	82.00	98.40
850mm	91.0118	89.00	106.80

TECHNICAL INFORMATION

Material: Steel

Vertical and Horizontal Radiators:

Flat & Double Flat Style Hangers are compatible with both Vertical and Horizontal radiators. (Depending on the radiators and hangers width)

Must be fitted before installation!

Hanger Fitting Widths
96/191/286/476/666mm



Hanger Fitting Widths
96/191/286/476/666mm

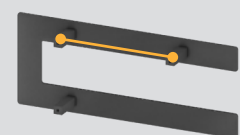

Aluminium Range

PERETTI FLAT TRIPLE TOWEL HANGER



Flat Triple Hanger - Brushed Stainless Steel

Size	Code	£ Ex VAT	£ Inc VAT
280mm	101.0048	142.00	170.40
375mm	101.0049	156.00	187.20
470mm	101.0050	178.00	213.60

Flat Triple Hanger - Polished Stainless Steel

Size	Code	£ Ex VAT	£ Inc VAT
280mm	101.0054	142.00	170.40
375mm	101.0055	156.00	187.20
470mm	101.0056	178.00	213.60

PERETTI CURVED TRIPLE TOWEL HANGER



Flat Triple Hanger - Brushed Stainless Steel

Size	Code	£ Ex VAT	£ Inc VAT
280mm	101.0051	142.00	170.40
375mm	101.0052	156.00	187.20
470mm	101.0053	178.00	213.60

Flat Triple Hanger - Polished Stainless Steel

Size	Code	£ Ex VAT	£ Inc VAT
280mm	101.0057	142.00	170.40
375mm	101.0058	156.00	187.20
470mm	101.0059	178.00	213.60

TECHNICAL INFORMATION

Material: **Stainless Steel - Grade 304**

Vertical Radiators:

1800mm height radiators comes with 3 pre-drilled towel hanger locations. 600mm height radiators come with 1 pre-drilled towel hanger location. The flat triple & curved triple towel hangers are only compatible with the Vertical Radiators and can be fitted to the pre-drilled holes on 1800mm & 600mm height radiators.

Can be fitted after installation!

Horizontal Radiators:

The flat triple & curved triple towel hangers are not suitable for horizontal radiators.

PERETTI - FLAT TOWEL SHELF



Flat Towel Shelves - Matt White

Size	Code	£ Ex VAT	£ Inc VAT
280mm	89.0468	37.00	44.40
375mm	89.0469	41.00	49.20
470mm	89.0470	44.00	52.80

Towel Shelves - Matt Anthracite

Size	Code	£ Ex VAT	£ Inc VAT
280mm	89.0471	37.00	44.40
375mm	89.0472	41.00	49.20
470mm	89.0473	44.00	52.80

Towel Shelves - Matt Black

Size	Code	£ Ex VAT	£ Inc VAT
280mm	89.0474	37.00	44.40
375mm	89.0475	41.00	49.20
470mm	89.0476	44.00	52.80

PERETTI - DESIGNER TOWEL SHELF



Designer Towel Shelves - Matt White

Size	Code	£ Ex VAT	£ Inc VAT
280mm	89.0450	65.00	78.00
375mm	89.0451	69.00	82.80
470mm	89.0452	72.00	86.40

Designer Towel Shelves - Matt Anthracite

Size	Code	£ Ex VAT	£ Inc VAT
280mm	89.0453	65.00	78.00
375mm	89.0454	69.00	82.80
470mm	89.0455	72.00	86.40

Designer Towel Shelves - Matt Black

Size	Code	£ Ex VAT	£ Inc VAT
280mm	89.0456	65.00	78.00
375mm	89.0457	69.00	82.80
470mm	89.0458	72.00	86.40

TECHNICAL INFORMATION

Material: **Steel**

Flat & Designer Towel Shelves are compatible with both Vertical and Horizontal radiators.

(Depending on the radiators and hangers width) * Compatible with Peretti Horizontal Radiators.

Must be fitted before installation!

Aluminium Range

GUARDIA VERTICAL

High Output 

Matt White



Warranty

5
Year

Heating



Pictured 86.0032 Matt White with 86.0119 Cover Caps x2

Aluminium Range

A versatile designer radiator which can be fitted to show the flat side or the curved profile of the panels, allowing the radiator to fit into your lifestyle and decor. Available in horizontal and vertical designs this radiator heats up quickly to warm your whole room.

Guardia Vertical Aluminium Radiators - Matt White						
Size H x W	Watts	BTU	Element Output	Element Type	Code	£ Ex VAT £ Inc VAT
1800 x 280mm	1368	4668	N/A	N/A	86.0029	284.00 340.80
1800 x 375mm	1824	6224	N/A	N/A	86.0032	368.00 441.60
1800 x 470mm	2280	7780	N/A	N/A	86.0035	453.00 543.60

Guardia Vertical Aluminium Radiators - Grey						
Size H x W	Watts	BTU	Element Output	Element Type	Code	£ Ex VAT £ Inc VAT
1800 x 280mm	1368	4668	N/A	N/A	86.0189	284.00 340.80
1800 x 375mm	1824	6224	N/A	N/A	86.0190	368.00 441.60
1800 x 470mm	2280	7780	N/A	N/A	86.0191	453.00 543.60

Guardia Vertical Aluminium Radiators - Matt Anthracite						
Size H x W	Watts	BTU	Element Output	Element Type	Code	£ Ex VAT £ Inc VAT
1800 x 280mm	1368	4668	N/A	N/A	86.0030	284.00 340.80
1800 x 375mm	1824	6224	N/A	N/A	86.0033	368.00 441.60
1800 x 470mm	2280	7780	N/A	N/A	86.0036	453.00 543.60

Guardia Vertical Aluminium Radiators - Matt Black						
Size H x W	Watts	BTU	Element Output	Element Type	Code	£ Ex VAT £ Inc VAT
1800 x 280mm	1368	4668	N/A	N/A	86.0031	284.00 340.80
1800 x 375mm	1824	6224	N/A	N/A	86.0034	368.00 441.60
1800 x 470mm	2280	7780	N/A	N/A	86.0037	453.00 543.60

FEATURES

- Can be reversed when hanging on the wall.
 - Excellent heat conductivity and lightweight.
 - Only requires a low water volume.
 - Heats up very quickly.
 - Radiators come with cover caps on top and bottom, same as radiator colour.
 - Manufactured and tested to EN442 standard.
 - CE Certification.
 - 5 Year Manufacturer's Warranty*
 - Not suitable for elements.
- * With conditions

TECHNICAL INFORMATION

All measurements in Height by Width. Heat output based on $\Delta T60^{\circ}\text{C}$. For matching valves see pages 630-634. Corrosion inhibitor must be added to the heating system and maintained. Flow diverter must only be fitted when radiator installed on central heating system. For indirect heating systems only. Tappings are the width of the rail and approx. 65mm off the wall.

Can be reversed when hanging on the wall. Either side can be used as front facing.



Flat Side



Curved Side

GUARDIA VERTICAL

Matt Grey

Matt Anthracite

Matt Black

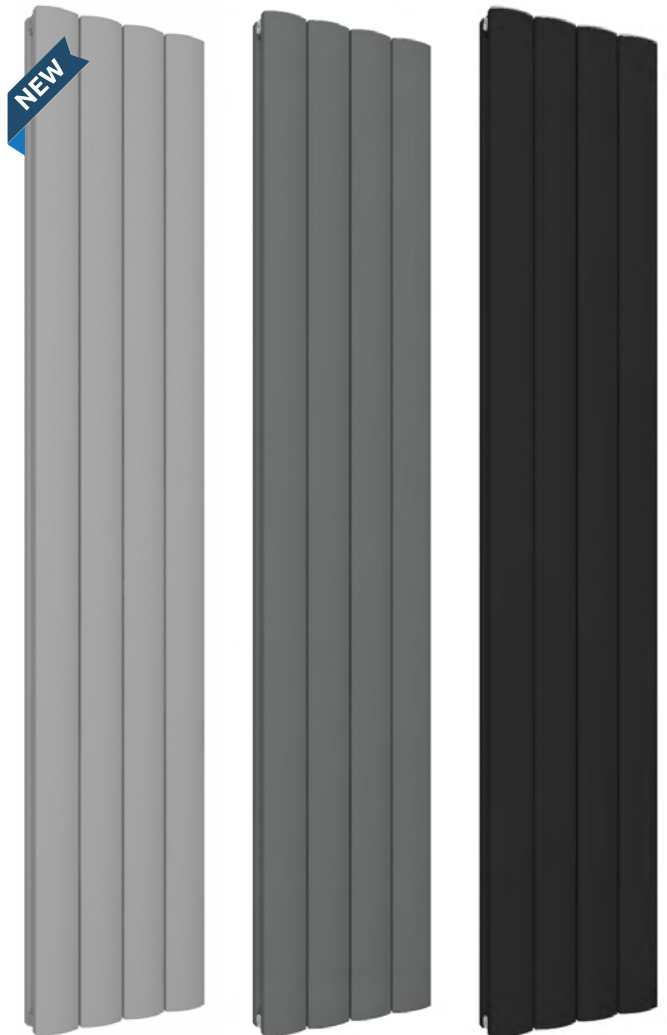

Guardia Cover Cap Sets - Chrome

Description	Code	£ Ex VAT	£ Inc VAT
Cover Cap Set 280mm	86.0118	14.00	16.80
Cover Cap Set 375mm	86.0119	18.00	21.60
Cover Cap Set 470mm	86.0120	21.00	25.20

Cover cap sets only include cover caps for the top of the radiator.

Bespoke RAL Colours
Page 638



Bespoke Sizes
Page 639



Aluminium Range

GUARDIA HORIZONTAL

Warranty
5
 Year

Heating

All Electric

Dual-Fuel



Pictured 86.0045 Matt Anthracite with Chrome Cover Caps 86.0122 (x2)



Pictured 86.0194 Matt Grey with Chrome Cover Caps 86.0122 (x2)



Guardia Cover Cap Sets - Chrome

Description	Code	£ Ex VAT	£ Inc VAT
Cover Cap Set 470mm	86.0120	21.00	25.20
Cover Cap Set 660mm	86.0121	29.00	34.80
Cover Cap Set 850mm	86.0122	36.00	43.20
Cover Cap Set 1040mm	86.0123	43.00	51.60
Cover Cap Set 1230mm	86.0124	50.00	60.00
Cover Cap Set 1420mm	86.0175	55.00	66.00

Cover cap sets only include cover caps for the top of the radiator.

For element types see pages 628-629.

Element can only be installed horizontally on the bottom header. When ordering fluid filled rails with elements, please specify the front facing side. The element will be fitted on the right hand side as standard.

Radiators that are electric only are restricted to the heat output of the elements (Type C up to 900 watts).



Flat Side

Curved Side

Aluminium Range

A versatile designer radiator which can be fitted to show the flat panel side or the curved style of the panels, allowing the radiator to fit into your lifestyle and decor. Available in horizontal and vertical designs this radiator heats up quickly to warm your whole room.

Guardia Horizontal Aluminium Radiators - Matt White							
Size H x W	Watts	BTU	Element Output	Element Type	Code	£ Ex VAT	£ Inc VAT
600 x 470mm	800	2730	300W	A or C	86.0038	201.00	241.20
600 x 660mm	1120	3822	600W	A or C	86.0041	269.00	322.80
600 x 850mm	1440	4913	600W	A or C	86.0044	338.00	405.60
600 x 1040mm	1790	6005	900W	A or C	86.0047	406.00	487.20
600 x 1230mm	2080	7097	900W	A or C	86.0050	475.00	570.00
600 x 1420mm	2400	8190	900W	A or C	86.0170	556.00	667.20

Guardia Horizontal Aluminium Radiators - Matt Grey							
Size H x W	Watts	BTU	Element Output	Element Type	Code	£ Ex VAT	£ Inc VAT
600 x 470mm	800	2730	300W	A or C	86.0192	201.00	241.20
600 x 660mm	1120	3822	600W	A or C	86.0193	269.00	322.80
600 x 850mm	1440	4913	600W	A or C	86.0194	338.00	405.60
600 x 1040mm	1790	6005	900W	A or C	86.0195	406.00	487.20
600 x 1230mm	2080	7097	900W	A or C	86.0196	475.00	570.00
600 x 1420mm	2400	8190	900W	A or C	86.0197	556.00	667.20

Guardia Horizontal Aluminium Radiators - Matt Anthracite							
Size H x W	Watts	BTU	Element Output	Element Type	Code	£ Ex VAT	£ Inc VAT
600 x 470mm	800	2730	300W	A or C	86.0039	201.00	241.20
600 x 660mm	1120	3822	600W	A or C	86.0042	269.00	322.80
600 x 850mm	1440	4913	600W	A or C	86.0045	338.00	405.60
600 x 1040mm	1790	6005	900W	A or C	86.0048	406.00	487.20
600 x 1230mm	2080	7097	900W	A or C	86.0051	475.00	570.00
600 x 1420mm	2400	8190	900W	A or C	86.0171	556.00	667.20

Guardia Horizontal Aluminium Radiators - Matt Black							
Size H x W	Watts	BTU	Element Output	Element Type	Code	£ Ex VAT	£ Inc VAT
600 x 470mm	800	2730	300W	A or C	86.0040	201.00	241.20
600 x 660mm	1120	3822	600W	A or C	86.0043	269.00	322.80
600 x 850mm	1440	4913	600W	A or C	86.0046	338.00	405.60
600 x 1040mm	1790	6005	900W	A or C	86.0049	406.00	487.20
600 x 1230mm	2080	7097	900W	A or C	86.0052	475.00	570.00
600 x 1420mm	2400	8190	900W	A or C	86.0172	556.00	667.20

FEATURES

- Can be reversed when hanging on the wall.
 - Excellent heat conductivity and lightweight.
 - Only requires a low water volume.
 - Heats up very quickly.
 - Radiators come with cover caps on top and bottom, same as radiator colour.
 - Manufactured and tested to EN442 standard.
 - CE Certification.
 - 5 Year Manufacturer's Warranty*
 - Not suitable for elements.
- * With conditions



TECHNICAL INFORMATION

All measurements in Height by Width. Heat output based on ▲T60°C. For matching valves see pages 630-634. Corrosion inhibitor must be added to the heating system and maintained. Flow diverter must only be fitted when radiator installed on central heating system. For indirect heating systems only. Tappings are the width of the rail and approx. 65mm off the wall.



GUARDIA HORIZONTAL

Matt White

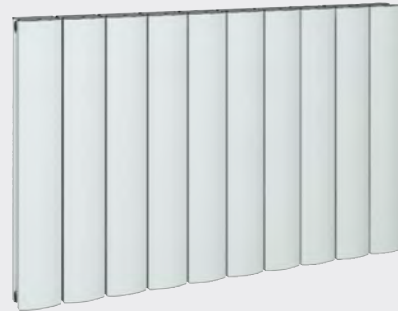

Matt Grey



Matt Anthracite

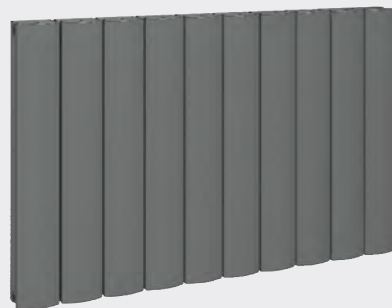

Matt Black



Bespoke RAL Colours
Page 638



Bespoke Sizes
Page 639



Aluminium Range

VESIMA VERTICAL

Pictured 86.0085 Matt Black



A sleek elegant radiator with clean lines which will provide a stylish focus to any room. Available in three colours as well as horizontal and vertical designs. Additional towel hangers available with the vertical design to allow versatility.

FEATURES

- Only requires a low water volume.
- Heats up very quickly.
- Radiators come with cover caps on top and bottom, same as radiator colour.
- Manufactured and tested to EN442 standard.
- CE Certification.
- 5 Year Manufacturer's Warranty*
- Can be single or dual fuel, or all electric.

* With conditions

Warranty

5

Year

Heating



All Electric



Dual-Fuel



Vesima Vertical Aluminium Radiators - Matt White

Size H x W	Watts	BTU	Element Output	Element Type	Code	£ Ex VAT	£ Inc VAT
1800 x 303mm	1068	3644	600W	A	86.0080	221.00	265.20
1800 x 403mm	1424	4859	900W	A	86.0083	279.00	334.80
1800 x 503mm	1780	6074	900W	A	86.0086	337.00	404.40

Vesima Vertical Aluminium Radiators - Matt Anthracite

Size H x W	Watts	BTU	Element Output	Element Type	Code	£ Ex VAT	£ Inc VAT
1800 x 303mm	1068	3644	600W	A	86.0081	221.00	265.20
1800 x 403mm	1424	4859	900W	A	86.0084	279.00	334.80
1800 x 503mm	1780	6074	900W	A	86.0087	337.00	404.40

Vesima Vertical Aluminium Radiators - Matt Black

Size H x W	Watts	BTU	Element Output	Element Type	Code	£ Ex VAT	£ Inc VAT
1800 x 303mm	1068	3644	600W	A	86.0082	221.00	265.20
1800 x 403mm	1424	4859	900W	A	86.0085	279.00	334.80
1800 x 503mm	1780	6074	900W	A	86.0088	337.00	404.40

Prices include radiator and wall fixing sets, valves and accessories extra.

Aluminium Range



Towel Hanger Colours Available

Premium Mirror Polished, Matt White, Matt Anthracite & Matt Black.
Pictured: Chrome.

Vesima Standard Towel Hangers

Size H x W	Colour	Code	£ Ex VAT	£ Inc VAT
Towel Hanger 303mm	Premium Mirror Polished	86.0204	45.00	54.00
Towel Hanger 403mm	Premium Mirror Polished	86.0205	48.00	57.60
Towel Hanger 503mm	Premium Mirror Polished	86.0206	54.00	64.80
Towel Hanger 303mm	Matt White	89.0195	36.00	43.20
Towel Hanger 403mm	Matt White	89.0196	39.00	46.80
Towel Hanger 503mm	Matt White	89.0197	45.00	54.00
Towel Hanger 303mm	Matt Anthracite	89.0198	36.00	43.20
Towel Hanger 403mm	Matt Anthracite	89.0199	39.00	46.80
Towel Hanger 503mm	Matt Anthracite	89.0200	45.00	54.00
Towel Hanger 303mm	Matt Black	89.0201	36.00	43.20
Towel Hanger 403mm	Matt Black	89.0202	39.00	46.80
Towel Hanger 503mm	Matt Black	89.0203	45.00	54.00
Towel Hanger 303mm	Chrome	86.0104	32.00	38.40
Towel Hanger 403mm	Chrome	86.0105	37.00	44.40
Towel Hanger 503mm	Chrome	86.0106	41.00	49.20

1800mm height radiators comes with 3 pre-drilled towel hanger locations, with a maximum of 3 towel hangers. (all widths; 303, 403 and 503mm) The Standard Towel Hangers are only compatible with the Vertical Radiators. Can be fitted after installation. The Vesima Standard Towel Hangers will add approx 8mm width on each side once fitted to the radiator.

For element types see pages 628-629.

Element can be installed vertically on the right-hand side or left-hand side on the bottom header. Radiators that are electric only are restricted to the heat output of the elements.

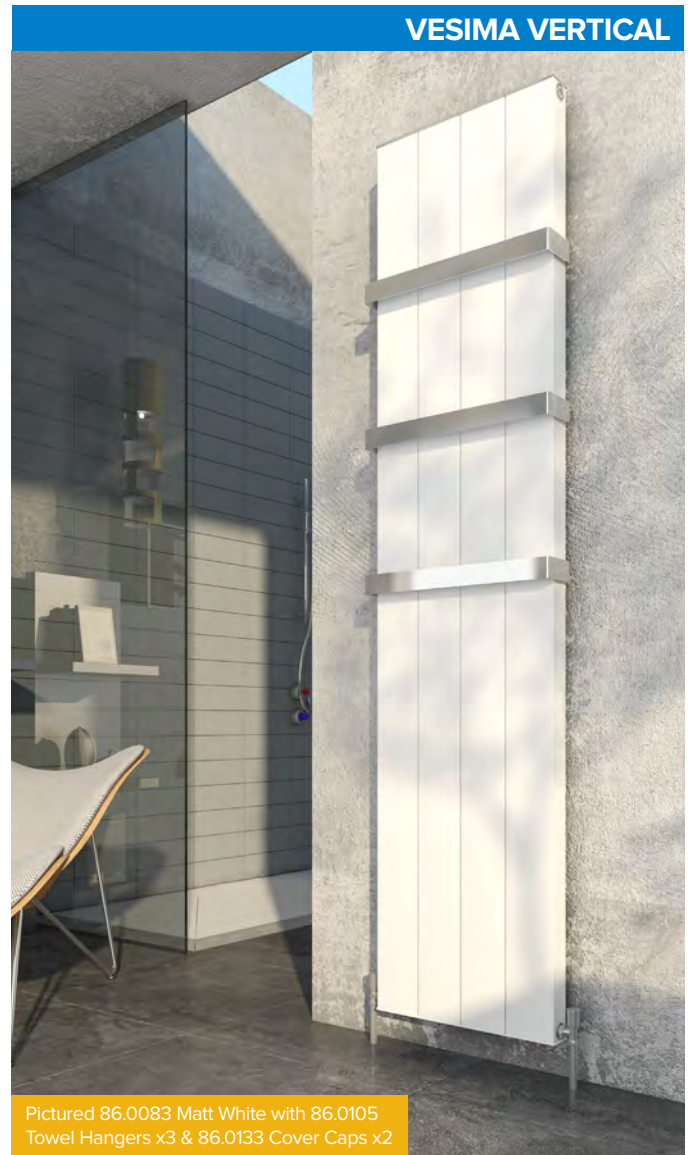
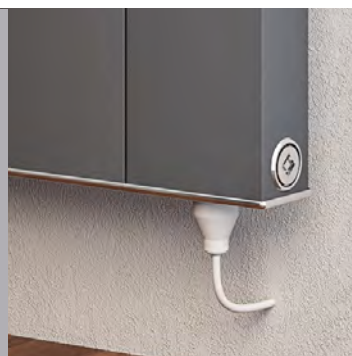

Pictured 86.0083 Matt White with 86.0105 Towel Hangers x3 & 86.0133 Cover Caps x2

TECHNICAL INFORMATION

All measurements in Height by Width. Heat output based on $\Delta T60^{\circ}C$. For matching valves see pages 630-634. Corrosion inhibitor must be added to the heating system and maintained. Flow diverter must only be fitted when radiator installed on central heating system. For indirect heating systems only. Tappings are the width of the rail and 60 or 80mm off the wall.



Vesima Cover Cap Sets - Chrome

Description	Code	£ Ex VAT	£ Inc VAT
Cover Cap Set 303mm	86.0132	14.00	16.80
Cover Cap Set 403mm	86.0133	17.00	20.40
Cover Cap Set 503mm	86.0134	21.00	25.20

Cover cap sets only include cover caps for the top of the radiator.

Bespoke RAL Colours

Page 638

Bespoke Sizes

Page 639

Aluminium Range

VESIMA HORIZONTAL

Pictured 86.0098 Matt White & 86.0137 Cover Caps x2



A sleek elegant radiator with clean lines which will provide a stylish focus to any room. Available in three colours as well as horizontal and vertical designs.

Vesima Horizontal Aluminium Radiators - Matt White

Size H x W	Watts	BTU	Element Output	Element Type	Code	£ Ex VAT	£ Inc VAT
600 x 503mm	660	2252	300W	A or C	86.0089	155.00	186.00
600 x 603mm	792	2702	300W	A or C	86.0092	178.00	213.60
600 x 803mm	1056	3603	600W	A or C	86.0095	225.00	270.00
600 x 1003mm	1320	4504	900W	A or C	86.0098	272.00	326.40
600 x 1203mm	1584	5405	900W	A or C	86.0101	320.00	384.00

Vesima Horizontal Aluminium Radiators - Matt Anthracite

Size H x W	Watts	BTU	Element Output	Element Type	Code	£ Ex VAT	£ Inc VAT
600 x 503mm	660	2252	300W	A or C	86.0090	155.00	186.00
600 x 603mm	792	2702	300W	A or C	86.0093	178.00	213.60
600 x 803mm	1056	3603	600W	A or C	86.0096	225.00	270.00
600 x 1003mm	1320	4504	900W	A or C	86.0099	272.00	326.40
600 x 1203mm	1584	5405	900W	A or C	86.0102	320.00	384.00

Vesima Horizontal Aluminium Radiators - Matt Black

Size H x W	Watts	BTU	Element Output	Element Type	Code	£ Ex VAT	£ Inc VAT
600 x 503mm	660	2252	300W	A or C	86.0091	155.00	186.00
600 x 603mm	792	2702	300W	A or C	86.0094	178.00	213.60
600 x 803mm	1056	3603	600W	A or C	86.0097	225.00	270.00
600 x 1003mm	1320	4504	900W	A or C	86.0100	272.00	326.40
600 x 1203mm	1584	5405	900W	A or C	86.0103	320.00	384.00

Prices include radiator and wall fixing sets, valves and accessories extra.

FEATURES

- Excellent heat conductivity and lightweight.
 - Only requires a low water volume.
 - Heats up very quickly.
 - Radiators come with cover caps on top and bottom, same as radiator colour.
 - Manufactured and tested to EN442 standard.
 - CE Certification.
 - 5 Year Manufacturer's Warranty*
 - Can be single or dual fuel, or all electric.
- * With conditions

Matt White



Matt Anthracite

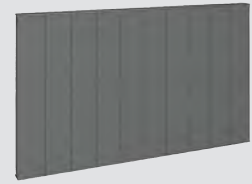

Matt Black



Vesima Cover Cap Sets

Cover cap sets only include cover caps for the top of the radiator.



Vesima Cover Cap Sets - Chrome

Description	Code	£ Ex VAT	£ Inc VAT
Cover Cap Set 503mm	86.0134	21.00	25.20
Cover Cap Set 603mm	86.0135	25.00	30.00
Cover Cap Set 803mm	86.0136	31.00	37.20
Cover Cap Set 1003mm	86.0137	39.00	46.80
Cover Cap Set 1203mm	86.0138	46.00	55.20

Bespoke Sizes

Page 639



Bespoke RAL Colours

Page 638



For element types see pages 628-629.

Element can be installed vertically on the right-hand side or left-hand side on the bottom header. Radiators that are electric only are restricted to the heat output of the elements (Type C up to 900 watts).



TECHNICAL INFORMATION

All measurements in Height by Width. Heat output based on ▲T60°C. For matching valves see pages 630-634. Corrosion inhibitor must be added to the heating system and maintained. Flow diverter must only be fitted when radiator installed on central heating system. For indirect heating systems only. Tappings are the width of the rail and 60 or 80mm off the wall.

Warranty

5
Year

Heating



All Electric



Dual-Fuel



Aluminium Range

PRESTON VERTICAL

Pictured 89.0162 Matt Anthracite with 89.0164 Towel Hangers x3 & 89.0175 Cover Caps x2



For element types see pages 628-629.

Element can only be installed vertically on the right hand side on the bottom header. Radiators that are electric only are restricted to the heat output of the elements.



Preston Cover Cap Sets - Chrome			
Cap Set Size	Code	£ Ex VAT	£ Inc VAT
185mm	89.0175	7.00	8.40

Cover cap set only includes cover caps for the top or bottom of the radiator.

Preston Standard Towel Hangers				
Hanger Size	Colour	Code	£ Ex VAT	£ Inc VAT
185mm	Premium Mirror Polished	86.0207	38.00	45.60
185mm	Matt White	89.0204	31.00	37.20
185mm	Matt Anthracite	89.0205	31.00	37.20
185mm	Matt Black	89.0206	31.00	37.20
185mm	Chrome	89.0164	26.00	31.20



1800mm height radiator comes with 3 pre-drilled towel hanger locations, with a maximum of 3 towel hangers. Can be fitted after installation. The Preston Standard Towel Hangers will add approx 23mm width on each side once fitted to the radiator.

Matt White	Matt Anthracite	Matt Black	Chrome
89.0204	89.0205	89.0206	89.0164

A slimline radiator ideal for those situations where space is at a minimum. With the additional extra towel hangers this radiator is ideal for drying kitchen or bathroom towels. Available in three finishes.

Preston Aluminium Radiators								
Size H x W	Watts	BTU	Element Output	Element Type	Colour	Code	£ Ex VAT	£ Inc VAT
1800 x 185mm	550	1876	300W	A	Matt White	89.0161	126.00	151.20
1800 x 185mm	550	1876	300W	A	Matt Anthracite	89.0162	126.00	151.20
1800 x 185mm	550	1876	300W	A	Matt Black	89.0163	126.00	151.20

Prices include radiator and wall fixing sets, valves and accessories extra.

FEATURES

- Excellent heat conductivity and lightweight.
 - Only requires a low water volume.
 - Heats up very quickly.
 - Manufactured and tested to EN442 standard.
 - CE Certification.
 - 5 Year Manufacturer's Warranty*
 - Can be single or dual fuel, or all electric.
 - Radiators come with cover caps on top and bottom, the same colour as the radiator.
- * With conditions

TECHNICAL INFORMATION

All measurements in Height by Width. Heat output based on $\Delta T60^{\circ}C$. For matching valves see pages 630-634. Corrosion inhibitor must be added to the heating system and maintained. Flow diverter must only be fitted when radiator installed on central heating system. For indirect heating systems only. Tappings are the width of the rail and 33 or 53mm off the wall.

Round Vent Caps

Page 637



Aluminium Range

BERLINI VERTICAL



SWATCHES AVAILABLE



Pictured 86.0186 Polished Aluminium with 86.0110 Towel Hangers x3 & 86.0139 Cover Caps x2



Pictured 86.0056 Matt White with 86.0110 Towel Hangers

This slimline radiator will be an ideal solution for those tight spaces. The radiator looks stunning paired with the towel hangers to complete the look. Available in four finishes, this radiator heats up quickly and is lightweight.

FEATURES

- Excellent heat conductivity and lightweight.
 - Only requires a low water volume.
 - Heats up very quickly.
 - Radiators come with cover caps on top and bottom, same as radiator colour.
 - Manufactured and tested to EN442 standard.
 - CE Certification.
 - 5 Year Manufacturer's Warranty*
 - Can be single or dual fuel, or all electric.
- * With conditions

Bespoke Sizes
Page 639



Bespoke RAL Colours
Page 618



Warranty

5

Year

Heating

All Electric

Dual-Fuel

Aluminium Range

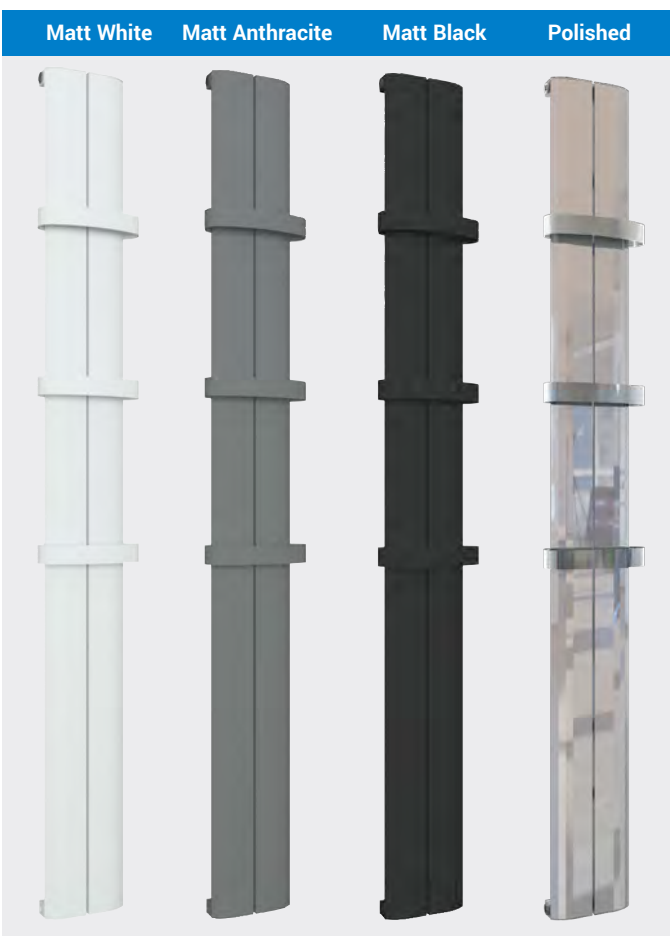

Berlini Aluminium Radiator - Matt White

Size H x W	Watts	BTU	Element Output	Element Type	Code	£ Ex VAT	£ Inc VAT
1200 x 185mm	421	1438	300W	A	86.0144	126.00	151.20
1800 x 185mm	632	2156	300W	A	86.0107	134.00	160.80

Berlini Aluminium Radiator - Matt Anthracite

Size H x W	Watts	BTU	Element Output	Element Type	Code	£ Ex VAT	£ Inc VAT
1200 x 185mm	408	1393	150W	A	86.0145	126.00	151.20
1800 x 185mm	613	2092	300W	A	86.0108	134.00	160.80

Berlini Aluminium Radiator - Matt Black

Size H x W	Watts	BTU	Element Output	Element Type	Code	£ Ex VAT	£ Inc VAT
1200 x 185mm	421	1438	300W	A	86.0146	126.00	151.20
1800 x 185mm	632	2156	300W	A	86.0109	134.00	160.80

Berlini Aluminium Radiator - Polished Aluminium

Size H x W	Watts	BTU	Element Output	Element Type	Code	£ Ex VAT	£ Inc VAT
1200 x 185mm	408	1393	150W	A	86.0185	137.00	164.40
1800 x 185mm	613	2092	300W	A	86.0186	158.00	189.60

Prices include radiator and wall fixing sets, valves and accessories extra.

TECHNICAL INFORMATION

All measurements in Height by Width. Heat output based on ▲T60°C. For matching valves see pages 630-634. Corrosion inhibitor must be added to the heating system and maintained. Flow diverter must only be fitted when radiator installed on central heating system. For indirect heating systems only. Tappings are the width of the rail and 35 or 55mm off the wall.

For element types see pages 628-629.

Element can only be installed vertically on the right hand side on the bottom header. Radiators that are electric only are restricted to the heat output of the elements.



Pictured 86.0145 Matt Anthracite with 89.0205 Towel Hangers x2 & 86.0139 Cover Caps x2

Berlini Cover Cap Set - Chrome

Description	Code	£ Ex VAT	£ Inc VAT
Cover Cap Set 185mm	86.0139	11.00	13.20

Cover cap sets only include cover caps for the top of the radiator.



Matt Black	Chrome	
89.0206	89.0164	
Matt White	Matt Anthracite	
89.0204	89.0205	
Premium Mirror Polished		
89.0207		

Berlini Standard Towel Hangers

Description	Colour	Code	£ Ex VAT	£ Inc VAT
Towel Hanger 185mm	Premium Mirror Polished	86.0207	38.00	45.60
Towel Hanger 185mm	Matt White	89.0204	31.00	37.20
Towel Hanger 185mm	Matt Anthracite	89.0205	31.00	37.20
Towel Hanger 185mm	Matt Black	89.0206	31.00	37.20
Towel Hanger 185mm	Chrome	86.0110	28.00	33.60

1800mm height radiator comes with 3 pre-drilled towel hanger locations, with a maximum of 3 towel hangers. 1200mm height radiators comes with 2 pre-drilled towel hanger locations, with a maximum of 2 towel hangers. Can be fitted after installation. The Preston Standard Towel Hangers will add approx 23mm width on each side once fitted to the radiator.

Aluminium Range

CHARLTON

Pictured 89.0128 Matt White with 89.0134 Towel Hangers



For element types see pages 628-629.

Element can only be installed vertically on the right-hand side on the bottom header. Radiators that are electric only are restricted to the heat output of the elements.



FEATURES

- Excellent heat conductivity and lightweight.
- Only requires a low water volume.
- Heats up very quickly.
- Radiators come with cover caps on top and bottom, same as radiator colour.
- Can be single, dual fuel or all electric.
- Manufactured and tested to EN442 standard.
- CE Certification.
- 5 Year Manufacturer's Warranty*
* With conditions

TECHNICAL INFORMATION

All measurements in Height by Width. Heat output based on $\Delta T60^{\circ}\text{C}$. For matching valves see pages 630-634. Corrosion inhibitor must be added to the heating system and maintained. Flow diverter must only be fitted when radiator installed on central heating system. For indirect heating systems only. Tappings are the width of the rail and 33 or 53mm off the wall.

Round Vent Caps Page 637



Warranty

5

Year

Heating

All Electric

Dual-Fuel

A contemporary versatile radiator style, that come in two finishes, with an optional extra of stylish towel hangers.

Charlton Aluminium Radiators - Matt White							
Size H x W	Watts	BTU	Element Output	Element Type	Code	£ Ex VAT	£ Inc VAT
1800 x 280mm	865	2948	300W	A	89.0128	183.00	219.60
1800 x 375mm	1152	3929	600W	A	89.0130	236.00	283.20
1800 x 470mm	1441	4915	600W	A	89.0132	287.00	344.40

Charlton Aluminium Radiators - Matt Anthracite							
Size H x W	Watts	BTU	Element Output	Element Type	Code	£ Ex VAT	£ Inc VAT
1800 x 280mm	865	2948	300W	A	89.0129	183.00	219.60
1800 x 375mm	1152	3929	600W	A	89.0131	236.00	283.20
1800 x 470mm	1441	4915	600W	A	89.0133	287.00	344.40

Prices include radiator and wall fixing sets, valves and accessories extra.



Charlton Cover Cap Sets - Chrome			
Description	Code	£ Ex VAT	£ Inc VAT
Cover Cap Set 280mm	89.0165	8.00	9.60
Cover Cap Set 375mm	89.0166	10.00	12.00
Cover Cap Set 470mm	89.0167	11.00	13.20

Cover cap sets only include cover caps for the top of the radiator.

Aluminium Range

CHARLTON STANDARD TOWEL HANGERS



Towel Hanger - Matt White				
Size	Code	£ Ex VAT	£ Inc VAT	
280mm	89.0177	34.00	40.80	
375mm	89.0178	37.00	44.40	
470mm	89.0179	42.00	50.40	



Towel Hanger - Matt Anthracite				
Size	Code	£ Ex VAT	£ Inc VAT	
280mm	89.0180	34.00	40.80	
375mm	89.0181	37.00	44.40	
470mm	89.0182	42.00	50.40	



Towel Hanger - Chrome				
Size	Code	£ Ex VAT	£ Inc VAT	
280mm	89.0134	30.00	36.00	
375mm	89.0135	32.00	38.40	
470mm	89.0136	36.00	43.20	

NEW



Towel Hanger - Mirror Polished Premium				
Size	Code	£ Ex VAT	£ Inc VAT	
280mm	86.0198	43.00	51.60	
375mm	86.0199	47.00	56.40	
470mm	86.0200	52.00	62.40	

TECHNICAL INFORMATION

Material: **Steel** (Premium: **Stainless Steel - Grade 304**)

Vertical Radiators:

1800mm height radiators come with 3 pre-drilled towel hanger locations, with a maximum of 3 towel hangers - (all widths; 280, 375 and 470mm).

Can be fitted after installation!

The Charlton Standard Towel Hangers will add approx 8mm width on each side once fitted to the radiator.

CHARLTON FLAT STYLE TOWEL HANGERS

SINGLE FLAT STYLE



Towel Hanger - Matt White				
Size	Code	£ Ex VAT	£ Inc VAT	
280mm	89.0283	40.00	48.00	
375mm	89.0284	45.00	54.00	
470mm	89.0285	51.00	61.20	
660mm	89.0286	58.00	69.60	
850mm	89.0287	65.00	78.00	

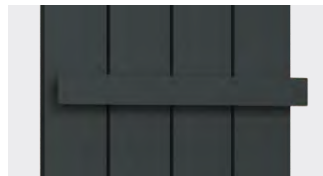

Towel Hanger - Matt Anthracite				
Size	Code	£ Ex VAT	£ Inc VAT	
280mm	89.0288	40.00	48.00	
375mm	89.0289	45.00	54.00	
470mm	89.0290	51.00	61.20	
660mm	89.0291	58.00	69.60	
850mm	89.0292	65.00	78.00	



Towel Hanger - Chrome				
Size	Code	£ Ex VAT	£ Inc VAT	
280mm	91.0094	56.00	67.20	
375mm	91.0095	57.00	68.40	
470mm	91.0096	59.00	70.80	
660mm	91.0097	62.00	74.40	
850mm	91.0098	66.00	79.20	

Hanger Fitting Widths
96/191/286/476/666mm



DOUBLE FLAT STYLE



Towel Hanger - Matt White				
Size	Code	£ Ex VAT	£ Inc VAT	
280mm	89.0369	50.00	60.00	
375mm	89.0370	54.00	64.80	
470mm	89.0371	61.00	73.20	
660mm	89.0372	70.00	84.00	
850mm	89.0373	78.00	93.60	



Towel Hanger - Matt Anthracite				
Size	Code	£ Ex VAT	£ Inc VAT	
280mm	89.0374	50.00	60.00	
375mm	89.0375	54.00	64.80	
470mm	89.0376	61.00	73.20	
660mm	89.0377	70.00	84.00	
850mm	89.0378	78.00	93.60	



Towel Hanger - Chrome				
Size	Code	£ Ex VAT	£ Inc VAT	
280mm	91.0114	71.00	85.20	
375mm	91.0115	73.00	87.60	
470mm	91.0116	75.00	90.00	
660mm	91.0117	82.00	98.40	
850mm	91.0118	89.00	106.80	

Hanger Fitting Widths
96/191/286/476/666mm



TECHNICAL INFORMATION

Material: **Steel**

Vertical Radiators:

Flat Style Hangers are compatible with both Vertical Radiators. (Depending on the radiators and hangers width)

Must be fitted before installation!

Aluminium Range

CHARLTON FLAT TRIPLE TOWEL HANGER



Flat Triple Hanger - Brushed Stainless Steel			
Size	Code	£ Ex VAT	£ Inc VAT
280mm	101.0048	142.00	170.40
375mm	101.0049	156.00	187.20
470mm	101.0050	178.00	213.60

Flat Triple Hanger - Polished Stainless Steel			
Size	Code	£ Ex VAT	£ Inc VAT
280mm	101.0054	142.00	170.40
375mm	101.0055	156.00	187.20

CHARLTON CURVED TRIPLE TOWEL HANGER



Flat Triple Hanger - Brushed Stainless Steel			
Size	Code	£ Ex VAT	£ Inc VAT
280mm	101.0051	142.00	170.40
375mm	101.0052	156.00	187.20
470mm	101.0053	178.00	213.60

Flat Triple Hanger - Polished Stainless Steel			
Size	Code	£ Ex VAT	£ Inc VAT
280mm	101.0057	142.00	170.40
375mm	101.0058	156.00	187.20

TECHNICAL INFORMATION

Material: Stainless Steel - Grade 304

Vertical Radiators:

1800mm height radiators comes with 3 pre-drilled towel hanger locations. The flat triple & curved triple towel hangers are only compatible with the Vertical Radiators and can be fitted to the pre-drilled holes on 1800mm height radiators.

Can be fitted after installation!

CHARLTON - FLAT TOWEL SHELF



Flat Towel Shelves - Matt White			
Size	Code	£ Ex VAT	£ Inc VAT
280mm	89.0459	34.00	40.80
375mm	89.0460	37.00	44.40
470mm	89.0461	41.00	49.20

Towel Shelves - Matt Anthracite			
Size	Code	£ Ex VAT	£ Inc VAT
280mm	89.0462	34.00	40.80
375mm	89.0463	37.00	44.40
470mm	89.0464	41.00	49.20

Towel Shelves - Matt Black			
Size	Code	£ Ex VAT	£ Inc VAT
280mm	89.0465	34.00	40.80
375mm	89.0466	37.00	44.40

CHARLTON - DESIGNER TOWEL SHELF



Designer Towel Shelves - Matt White			
Size	Code	£ Ex VAT	£ Inc VAT
280mm	89.0441	62.00	74.40
375mm	89.0442	65.00	78.00
470mm	89.0443	69.00	82.80

Designer Towel Shelves - Matt Anthracite			
Size	Code	£ Ex VAT	£ Inc VAT
280mm	89.0444	62.00	74.40
375mm	89.0445	65.00	78.00
470mm	89.0446	69.00	82.80

Designer Towel Shelves - Matt Black			
Size	Code	£ Ex VAT	£ Inc VAT
280mm	89.0447	62.00	74.40
375mm	89.0448	65.00	78.00

TECHNICAL INFORMATION

Material: Steel

Flat & Designer Towel Shelves are compatible with both Vertical and Horizontal radiators.

(Depending on the radiators and hangers width) * Compatible with Peretti Horizontal Radiators.

Must be fitted before installation!

Aluminium Range

WITHINGTON



Warranty
5
Year

Heating

All Electric

Dual-Fuel

For element types see pages 628-629.

Element can only be installed vertically on the right-hand side on the bottom header. Radiators that are electric only are restricted to the heat output of the elements.



FEATURES

- Excellent heat conductivity and lightweight.
- Only requires a low water volume.
- Heats up very quickly.
- Radiators come with cover caps on top and bottom, same as radiator colour.
- Can be single, dual fuel or all electric.
- Manufactured and tested to EN442 standard.
- CE Certification.
- 5 Year Manufacturer's Warranty*
* With conditions

TECHNICAL INFORMATION

All measurements in Height by Width. Heat output based on $\Delta T60^{\circ}C$. For matching valves see pages 630-634. Corrosion inhibitor must be added to the heating system and maintained. Flow diverter must only be fitted when radiator installed on central heating system. For indirect heating systems only. Tappings are the width of the rail and 33 or 53mm off the wall.

Round Vent Caps
Page 637



Pictured 89.0142 Matt Anthracite with 86.0079 Towel Hangers x3 & 89.0170 Cover Caps x2

An elegant designer radiator with clean lines which will be the centre of attention in any room. Towel hangers and chrome caps are available as an additional extra.

Withington Aluminium Radiators - Matt White

Size H x W	Watts	BTU	Element Output	Element Type	Code	£ Ex VAT	£ Inc VAT
1800 x 280mm	838	2858	300W	A	89.0137	183.00	219.60
1800 x 375mm	1127	3843	600W	A	89.0139	236.00	283.20
1800 x 470mm	1415	4824	600W	A	89.0141	287.00	344.40

Withington Aluminium Radiators - Matt Anthracite

Size H x W	Watts	BTU	Element Output	Element Type	Code	£ Ex VAT	£ Inc VAT
1800 x 280mm	838	2858	300W	A	89.0138	183.00	219.60
1800 x 375mm	1127	3843	600W	A	89.0140	236.00	283.20
1800 x 470mm	1415	4824	600W	A	89.0142	287.00	344.40

Prices include radiator and wall fixing sets, valves and accessories extra.



Withington Cover Cap Sets - Chrome

Description	Code	£ Ex VAT	£ Inc VAT
Cover Cap Set 280mm	89.0168	8.00	9.60
Cover Cap Set 375mm	89.0169	10.00	12.00
Cover Cap Set 470mm	89.0170	11.00	13.20

Cover Caps Chrome: The cover cap set only includes cover caps for the top and the bottom of the radiator.

Aluminium Range

WITHINGTON STANDARD TOWEL HANGERS



Towel Hanger - Matt White			
Size	Code	£ Ex VAT	£ Inc VAT
280mm	89.0186	34.00	40.80
375mm	89.0187	37.00	44.40
470mm	89.0188	42.00	50.40



Towel Hanger - Matt Anthracite			
Size	Code	£ Ex VAT	£ Inc VAT
280mm	89.0189	34.00	40.80
375mm	89.0190	37.00	44.40
470mm	89.0191	42.00	50.40



Towel Hanger - Chrome			
Size	Code	£ Ex VAT	£ Inc VAT
280mm	86.0077	31.00	37.20
375mm	86.0078	36.00	43.20
470mm	86.0079	40.00	48.00



Towel Hanger - Mirror Polished Premium			
Size	Code	£ Ex VAT	£ Inc VAT
280mm	86.0201	43.00	51.60
375mm	86.0202	47.00	56.40
470mm	86.0203	52.00	62.40

TECHNICAL INFORMATION

Material: Steel (Premium: Stainless Steel - Grade 304)

Vertical Radiators:

1800mm height radiators comes with 3 pre-drilled towel hanger locations, with a maximum of 3 towel hangers - (all widths; 280, 375 and 470mm).

Can be fitted after installation!

The Withington Standard Towel Hangers will add approx 8mm width to each side once fitted to the radiator.

WITHINGTON FLAT STYLE TOWEL HANGERS

SINGLE FLAT STYLE



Towel Hanger - Matt White			
Size	Code	£ Ex VAT	£ Inc VAT
280mm	89.0283	40.00	48.00
375mm	89.0284	45.00	54.00
470mm	89.0285	51.00	61.20
660mm	89.0286	58.00	69.60
850mm	89.0287	65.00	78.00

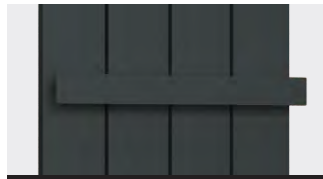

Towel Hanger - Matt Anthracite			
Size	Code	£ Ex VAT	£ Inc VAT
280mm	89.0288	40.00	48.00
375mm	89.0289	45.00	54.00
470mm	89.0290	51.00	61.20
660mm	89.0291	58.00	69.60
850mm	89.0292	65.00	78.00



Towel Hanger - Chrome			
Size	Code	£ Ex VAT	£ Inc VAT
280mm	91.0094	56.00	67.20
375mm	91.0095	57.00	68.40
470mm	91.0096	59.00	70.80
660mm	91.0097	62.00	74.40
850mm	91.0098	66.00	79.20

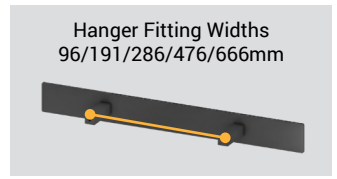

DOUBLE FLAT STYLE



Towel Hanger - Matt White			
Size	Code	£ Ex VAT	£ Inc VAT
280mm	89.0369	50.00	60.00
375mm	89.0370	54.00	64.80
470mm	89.0371	61.00	73.20
660mm	89.0372	70.00	84.00
850mm	89.0373	78.00	93.60



Towel Hanger - Matt Anthracite			
Size	Code	£ Ex VAT	£ Inc VAT
280mm	89.0374	50.00	60.00
375mm	89.0375	54.00	64.80
470mm	89.0376	61.00	73.20
660mm	89.0377	70.00	84.00
850mm	89.0378	78.00	93.60



Towel Hanger - Chrome			
Size	Code	£ Ex VAT	£ Inc VAT
280mm	91.0114	71.00	85.20
375mm	91.0115	73.00	87.60
470mm	91.0116	75.00	90.00
660mm	91.0117	82.00	98.40
850mm	91.0118	89.00	106.80

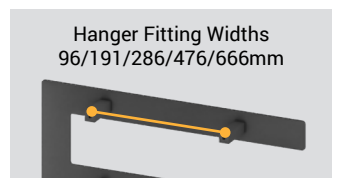

TECHNICAL INFORMATION

Material: Steel

Vertical Radiators:

Flat Style Hangers are compatible with Vertical radiators.(Depending on the radiators and hangers width)

Must be fitted before installation!

Aluminium Range

WITHINGTON FLAT TRIPLE TOWEL HANGER



Flat Triple Hanger - Brushed Stainless Steel

Size	Code	£ Ex VAT	£ Inc VAT
280mm	101.0048	142.00	170.40
375mm	101.0049	156.00	187.20
470mm	101.0050	178.00	213.60

Flat Triple Hanger - Polished Stainless Steel

Size	Code	£ Ex VAT	£ Inc VAT
280mm	101.0054	142.00	170.40
375mm	101.0055	156.00	187.20

WITHINGTON CURVED TRIPLE TOWEL HANGER



Flat Triple Hanger - Brushed Stainless Steel

Size	Code	£ Ex VAT	£ Inc VAT
280mm	101.0051	142.00	170.40
375mm	101.0052	156.00	187.20
470mm	101.0053	178.00	213.60

Flat Triple Hanger - Polished Stainless Steel

Size	Code	£ Ex VAT	£ Inc VAT
280mm	101.0057	142.00	170.40
375mm	101.0058	156.00	187.20

TECHNICAL INFORMATION

Material: **Stainless Steel - Grade 304**

Vertical Radiators:

1800mm height radiators comes with 3 pre-drilled towel hanger locations. The flat triple & curved triple towel hangers are only compatible with the Vertical Radiators and can be fitted to the pre-drilled holes on 1800mm height radiators.

Can be fitted after installation!

WITHINGTON - FLAT TOWEL SHELF



Flat Towel Shelves - Matt White

Size	Code	£ Ex VAT	£ Inc VAT
280mm	89.0468	37.00	44.40
375mm	89.0469	41.00	49.20
470mm	89.0470	44.00	52.80

Towel Shelves - Matt Anthracite

Size	Code	£ Ex VAT	£ Inc VAT
280mm	89.0471	37.00	44.40
375mm	89.0472	41.00	49.20
470mm	89.0473	44.00	52.80

WITHINGTON - DESIGNER TOWEL SHELF



Designer Towel Shelves - Matt White

Size	Code	£ Ex VAT	£ Inc VAT
280mm	89.0450	65.00	78.00
375mm	89.0451	69.00	82.80
470mm	89.0452	72.00	86.40

Designer Towel Shelves - Matt Anthracite

Size	Code	£ Ex VAT	£ Inc VAT
280mm	89.0453	65.00	78.00
375mm	89.0454	69.00	82.80
470mm	89.0455	72.00	86.40

TECHNICAL INFORMATION

Material: **Steel**

Flat & Designer Towel Shelves are compatible with Vertical radiators. (Depending on the radiators and hangers width) * Compatible with Peretti Horizontal Radiators.

Must be fitted before installation!

Aluminium Range

MALMESBURY VERTICAL

Pictured 89.0480 Matt Cappuccino with 89.0490 Towel Hangers



SWATCHES AVAILABLE



A designer radiator range available in both Vertical and Horizontal designs in Matt White, Matt Anthracite, Matt Cappuccino or Matt Grey finishes. Optional extras include chrome cover caps and towel hangers.

FEATURES

- Excellent heat conductivity and lightweight.
 - Only requires a low water volume.
 - Heats up very quickly.
 - Radiators come with cover caps on top and bottom, same as radiator colour.
 - Can be single, dual fuel or all electric.
 - Manufactured and tested to EN442 standard.
 - CE Certification.
 - 5 Year Manufacturer's Warranty*
- * With conditions



Pictured 89.0279 Matt Grey with 89.0301 Towel Hangers

Warranty

5
Year

Heating



All Electric



Dual-Fuel



Aluminium Range

Malmesbury Vertical Aluminium Radiators - Matt White

Size H x W	Watts	BTU	Element Output	Element Type	Code	£ Ex VAT	£ Inc VAT
1800 x 185mm	540	1841	150W	A	89.0277	137.00	164.40
1800 x 280mm	809	2759	300W	A	89.0146	195.00	234.00
1800 x 375mm	1078	3675	600W	A	89.0148	249.00	298.80
1800 x 470mm	1348	4597	600W	A	89.0150	305.00	366.00

Malmesbury Vertical Aluminium Radiators - Matt Grey

Size H x W	Watts	BTU	Element Output	Element Type	Code	£ Ex VAT	£ Inc VAT
1800 x 185mm	540	1841	150W	A	89.0279	137.00	164.40
1800 x 280mm	809	2759	300W	A	89.0280	195.00	234.00
1800 x 375mm	1078	3675	600W	A	89.0281	249.00	298.80
1800 x 470mm	1348	4597	600W	A	89.0282	305.00	366.00

Malmesbury Vertical Aluminium Radiators - Matt Anthracite

Size H x W	Watts	BTU	Element Output	Element Type	Code	£ Ex VAT	£ Inc VAT
1800 x 185mm	540	1841	150W	A	89.0278	137.00	164.40
1800 x 280mm	809	2759	300W	A	89.0147	195.00	234.00
1800 x 375mm	1078	3675	600W	A	89.0149	249.00	298.80
1800 x 470mm	1348	4597	600W	A	89.0151	305.00	366.00

Malmesbury Vertical Aluminium Radiators - Matt Cappuccino

Size H x W	Watts	BTU	Element Output	Element Type	Code	£ Ex VAT	£ Inc VAT
1800 x 185mm	540	1841	150W	A	89.0477	152.00	182.40
1800 x 280mm	809	2759	300W	A	89.0478	217.00	260.40
1800 x 375mm	1078	3675	600W	A	89.0479	279.00	334.80
1800 x 470mm	1348	4597	600W	A	89.0480	341.00	409.20

Prices include radiator and wall fixing sets, valves and accessories extra.



Malmesbury Cover Caps - Chrome

Description	Code	£ Ex VAT	£ Inc VAT
Cover Cap Set 185mm	89.0422	9.00	10.80
Cover Cap Set 280mm	89.0171	9.00	10.80
Cover Cap Set 375mm	89.0172	10.00	12.00
Cover Cap Set 470mm	89.0173	12.00	14.40

Cover Caps Chrome The cover cap set only includes cover caps for the top or the bottom of the radiator.

For element types
see pages 628-629.

Element can only be installed vertically on the right-hand side on the bottom header. Radiators that are electric only are restricted to the heat output of the elements.



TECHNICAL INFORMATION

All measurements in Height by Width. Heat output based on $\Delta T60^{\circ}\text{C}$. For matching valves see pages 630-634. Corrosion inhibitor must be added to the heating system and maintained. Flow diverter must only be fitted when radiator installed on central heating system. For indirect heating systems only. Tappings are the width of the rail and 33 or 53mm off the wall.

Round Vent Caps

Page 637



MALMESBURY VERTICAL

Pictured 89.0148 Matt White with 89.0159 Towel Hangers



For all Malmesbury Matt White, Matt Anthracite, Matt Cappuccino, Matt Grey & Chrome Towel Hangers, please refer to page 599.

Aluminium Range

MALMESBURY HORIZONTAL



Pictured 89.0425 Matt White

An aluminium radiator range available in both vertical and horizontal designs in matt white, matt anthracite, matt cappuccino or matt grey finishes. Optional extras include chrome cover caps and towel hangers.

500mm Height

Malmesbury Horizontal Aluminium Radiators - Matt White

Size H x W	Watts	BTU	Element Output	Element Type	Code	£ Ex VAT	£ Inc VAT
500 x 375mm	351	1196	150W	A or C	89.0432	116.00	139.20
500 x 470mm	438	1493	300W	A or C	89.0433	144.00	172.80
500 x 565mm	526	1793	300W	A or C	89.0434	169.00	202.80

Malmesbury Horizontal Aluminium Radiators - Matt Grey

Size H x W	Watts	BTU	Element Output	Element Type	Code	£ Ex VAT	£ Inc VAT
500 x 375mm	351	1196	150W	A or C	89.0435	116.00	139.20
500 x 470mm	438	1493	300W	A or C	89.0436	144.00	172.80
500 x 565mm	526	1793	300W	A or C	89.0437	169.00	202.80

Malmesbury Horizontal Aluminium Radiators - Matt Anthracite

Size H x W	Watts	BTU	Element Output	Element Type	Code	£ Ex VAT	£ Inc VAT
500 x 375mm	351	1196	150W	A or C	89.0438	116.00	139.20
500 x 470mm	438	1493	300W	A or C	89.0439	144.00	172.80
500 x 565mm	526	1793	300W	A or C	89.0440	169.00	202.80

FEATURES

- Excellent heat conductivity and lightweight.
 - Only requires a low water volume.
 - Heats up very quickly.
 - Radiators come with cover caps on top and bottom, same as radiator colour.
 - Can be single, dual fuel or all electric.
 - Manufactured and tested to EN442 standard.
 - CE Certification.
 - 5 Year Manufacturer's Warranty*
- * With conditions

Round Vent Caps

Page 637



Warranty

5
Year

Heating



All Electric



Dual-Fuel



Aluminium Range

600mm Height

Malmesbury Horizontal Aluminium Radiators - Matt White

Size H x W	Watts	BTU	Element Output	Element Type	Code	£ Ex VAT	£ Inc VAT
600 x 375mm	422	1437	300W	A or C	89.0152	125.00	150.00
600 x 470mm	526	1795	300W	A or C	89.0154	156.00	187.20
600 x 565mm	632	2156	300W	A or C	89.0156	183.00	219.60
600 x 850mm	949	3236	600W	A or C	89.0423	261.00	313.20
600 x 1040mm	1157	3945	600W	A or C	89.0424	318.00	381.60
600 x 1230mm	1369	4668	600W	A or C	89.0425	376.00	451.20

Malmesbury Horizontal Aluminium Radiators - Matt Grey

Size H x W	Watts	BTU	Element Output	Element Type	Code	£ Ex VAT	£ Inc VAT
600 x 375mm	422	1437	300W	A or C	89.0274	125.00	150.00
600 x 470mm	526	1795	300W	A or C	89.0275	156.00	187.20
600 x 565mm	632	2156	300W	A or C	89.0276	183.00	219.60
600 x 850mm	949	3236	600W	A or C	89.0426	261.00	313.20
600 x 1040mm	1157	3945	600W	A or C	89.0427	318.00	381.60
600 x 1230mm	1369	4668	600W	A or C	89.0428	376.00	451.20

Malmesbury Horizontal Aluminium Radiators - Matt Anthracite

Size H x W	Watts	BTU	Element Output	Element Type	Code	£ Ex VAT	£ Inc VAT
600 x 375mm	422	1437	300W	A or C	89.0153	125.00	150.00
600 x 470mm	526	1795	300W	A or C	89.01	156.00	187.20
600 x 565mm	632	2156	300W	A or C	89.0157	183.00	219.60
600 x 850mm	949	3236	600W	A or C	89.0429	261.00	313.20
600 x 1040mm	1157	3945	600W	A or C	89.0430	318.00	381.60
600 x 1230mm	1369	4668	600W	A or C	89.0431	376.00	451.20

Malmesbury Horizontal Aluminium Radiators - Matt Cappuccino

Size H x W	Watts	BTU	Element Output	Element Type	Code	£ Ex VAT	£ Inc VAT
600 x 375mm	422	1437	300W	A or C	89.0481	140.00	168.00
600 x 470mm	526	1795	300W	A or C	89.0482	174.00	208.80
600 x 565mm	632	2156	300W	A or C	89.0483	204.00	244.80
600 x 850mm	949	3236	600W	A or C	89.0484	306.00	367.20
600 x 1040mm	1157	3945	600W	A or C	89.0485	374.00	448.80
600 x 1230mm	1369	4668	600W	A or C	89.0486	442.00	530.40

Prices include radiator and wall fixing sets, valves and accessories extra.



Malmesbury Cover Caps - Chrome

Description	Code	£ Ex VAT	£ Inc VAT
Cover Cap Set 375mm	89.0172	10.00	12.00
Cover Cap Set 470mm	89.0173	12.00	14.40
Cover Cap Set 565mm	89.0174	14.00	16.80
Cover Cap Set 850mm	89.0497	20.00	24.00
Cover Cap Set 1040mm	89.0498	24.00	28.80
Cover Cap Set 1230mm	89.0499	28.00	33.60

Cover Caps Chrome The cover cap set only includes cover caps for the top or the bottom of the radiator.

For element types see pages 628-629.

Element can only be installed horizontally on the bottom header. Radiators that are electric only are restricted to the heat output of the elements (Type C up to 900 watts).



MALMESBURY HORIZONTAL



Pictured 89.0439 Matt Anthracite with 89.0160 Towel Hangers



Pictured 89.0437 Matt Grey

TECHNICAL INFORMATION

All measurements in Height by Width. Heat output based on $\Delta T60^{\circ}\text{C}$. For matching valves see pages 630-634. Corrosion inhibitor must be added to the heating system and maintained. Flow diverter must only be fitted when radiator installed on central heating system. For indirect heating systems only. Tappings are the width of the rail and 33 or 53mm off the wall.

Aluminium Range

MATT WHITE



SWATCHES AVAILABLE

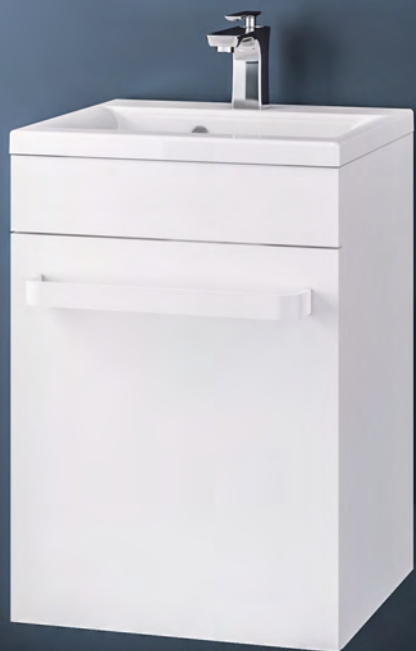

COMPLETE THE LOOK

Pictured:
Oslo 44 Internal Drawer Unit
See page 344



MATT GREY

COMPLETE THE LOOK

Pictured:
Helston Tap Basin Mono
See page 696

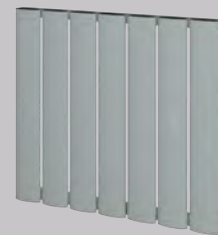

MATT ANTHRACITE

COMPLETE THE LOOK

Pictured:
Oslo 44 Drawer Unit
See page 335

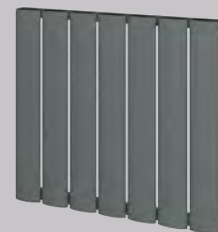

MATT CAPPUCCINO

COMPLETE THE LOOK

Pictured:
Helston Tap Basin Mono
See page 696

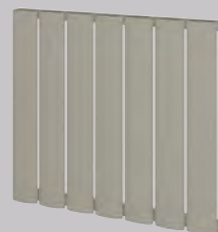

Aluminium Range

MALMESBURY STANDARD TOWEL HANGERS



Towel Hanger - Matt White			
Size	Code	£ Ex VAT	£ Inc VAT
185mm	89.0298	27.00	32.40
280mm	89.0215	32.00	38.40
375mm	89.0207	35.00	42.00
470mm	89.0208	40.00	48.00
565mm	89.0209	43.00	51.60



Towel Hanger - Matt Grey			
Size	Code	£ Ex VAT	£ Inc VAT
185mm	89.0300	27.00	32.40
280mm	89.0302	30.00	36.00
375mm	89.0303	32.00	38.40
470mm	89.0304	36.00	43.20
565mm	89.0305	39.00	46.80



Towel Hanger - Matt Anthracite			
Size	Code	£ Ex VAT	£ Inc VAT
185mm	89.0299	27.00	32.40
280mm	89.0216	32.00	38.40
375mm	89.0210	35.00	42.00
470mm	89.0211	40.00	48.00
565mm	89.0212	43.00	51.60



Towel Hanger - Matt Cappuccino			
Size	Code	£ Ex VAT	£ Inc VAT
185mm	89.0487	29.00	34.80
280mm	89.0488	32.00	38.40
375mm	89.0489	35.00	42.00
470mm	89.0490	40.00	48.00
565mm	89.0491	43.00	51.60



Towel Hanger - Chrome			
Size	Code	£ Ex VAT	£ Inc VAT
185mm	89.0301	27.00	32.40
280mm	89.0158	30.00	36.00
375mm	89.0159	32.00	38.40
470mm	89.0160	36.00	43.20
565mm	89.0176	39.00	46.80

TECHNICAL INFORMATION

Vertical Radiators:

1800mm height radiators comes with 3 pre-drilled towel hanger locations, with a maximum of 3 towel hangers - (all widths; 185, 280, 375 and 470mm). The standard towel hangers are only compatible with the Vertical Radiators.

Can be fitted after installation!

Material: **Steel**

Horizontal Radiators:

500mm & 600mm height radiators come with 1 pre-drilled towel hanger location, with a maximum of 1 towel hanger - (only 375, 470 and 565mm widths).

Standard towel hanger can be fitted.

Can be fitted after installation !

The Malmesbury Standard Towel Hangers will add approx 22mm width on each side once fitted to the radiator.

MALMESBURY FLAT STYLE TOWEL HANGERS

SINGLE FLAT STYLE



Towel Hanger - Matt White			
Size	Code	£ Ex VAT	£ Inc VAT
280mm	89.0306	47.00	56.40
375mm	89.0307	51.00	61.20
470mm	89.0308	54.00	64.80
565mm	89.0309	67.00	80.40



Towel Hanger - Matt Grey			
Size	Code	£ Ex VAT	£ Inc VAT
280mm	89.0314	47.00	56.40
375mm	89.0315	51.00	61.20
470mm	89.0316	54.00	64.80
565mm	89.0317	67.00	80.40



Towel Hanger - Matt Anthracite			
Size	Code	£ Ex VAT	£ Inc VAT
280mm	89.0310	47.00	56.40
375mm	89.0311	51.00	61.20
470mm	89.0312	54.00	64.80
565mm	89.0313	67.00	80.40



Towel Hanger - Matt Cappuccino			
Size	Code	£ Ex VAT	£ Inc VAT
280mm	89.0492	52.00	62.40
375mm	89.0493	57.00	68.40
470mm	89.0494	60.00	72.00
565mm	89.0495	74.00	88.80

TECHNICAL INFORMATION

Vertical and Horizontal Radiators:

Single Flat style hangers are compatible with both Vertical and Horizontal radiators. (Depending on the radiators and hangers width)

Must be fitted before installation!

Material: **Steel**

Hanger Fitting Widths
96/191/286/476/666mm



Aluminium Range

FAIRFORD VERTICAL

Warranty
5
Year

Heating

All Electric

Dual-Fuel



Pictured 89.0227 Matt Anthracite with 89.0320 Towel Hangers

This slimline radiator is an ideal solution for those tight or tall spaces. This wavy element design has a curved front that will provide a stylish warmth to any room. Available in two colours as well as horizontal and vertical designs.

FEATURES

- Excellent heat conductivity and lightweight.
 - Only requires a low water volume.
 - Heats up very quickly.
 - Radiators come with cover caps on top and bottom, same as radiator colour.
 - Manufactured and tested to EN442 standard.
 - CE Certification.
 - 5 Year Manufacturer's Warranty*
 - Can be single or dual fuel, or all electric.
- * With conditions

Round Vent Caps Page 637

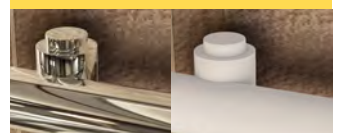

Aluminium Range

FAIRFORD VERTICAL

Pictured 89.0222 Matt White with 89.0322 Towel Hangers

Fairford Vertical Aluminium Radiators - Matt White

Size H x W	Watts	BTU	Element Output	Element Type	Code	£ Ex VAT	£ Inc VAT
1200 x 375mm	856	2919	300W	A	89.0221	237.00	284.40
1800 x 375mm	1288	4392	600W	A	89.0222	275.00	330.00

Fairford Vertical Aluminium Radiators - Matt Anthracite

Size H x W	Watts	BTU	Element Output	Element Type	Code	£ Ex VAT	£ Inc VAT
1200 x 375mm	856	2919	300W	A	89.0227	237.00	284.40
1800 x 375mm	1288	4392	600W	A	89.0228	275.00	330.00

Prices include radiator and wall fixing sets, valves and accessories extra.



Fairford Cover Caps - Chrome

Description	Code	£ Ex VAT	£ Inc VAT
Cover Cap 375mm	89.0399	10.00	12.00

Cover cap set only includes cover caps for the top or bottom of the radiator.

For element types see pages 628-629.

Element can only be installed vertically on the right-hand side on the bottom header. Radiators that are electric only are restricted to the heat output of the elements.



TECHNICAL INFORMATION

All measurements in Height by Width. Heat output based on $\Delta T60^{\circ}\text{C}$. For matching valves see pages 630-634. Corrosion inhibitor must be added to the heating system and maintained. Flow diverter must only be fitted when radiator installed on central heating system. For indirect heating systems only. Tappings are the width of the rail and 33 or 53mm off the wall.

FAIRFORD STANDARD TOWEL HANGERS



Towel Hanger - Matt White

Size	Code	£ Ex VAT	£ Inc VAT
375mm	89.0318	32.00	38.40

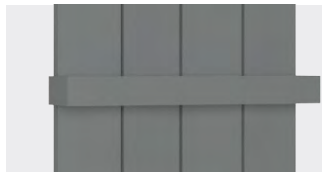

Towel Hanger - Matt Anthracite

Size	Code	£ Ex VAT	£ Inc VAT
375mm	89.0320	32.00	38.40



Towel Hanger - Chrome

Size	Code	£ Ex VAT	£ Inc VAT
375mm	89.0322	32.00	38.40

1800mm height radiators comes with 3 pre-drilled towel hanger locations, with a maximum of 3 towel hangers.

1200mm height radiators comes with 2 pre-drilled towel hanger locations, with a maximum of 2 towel hangers.

The standard towel hangers are compatible with the Vertical radiators. (Depending on the radiators and hangers width)



Can be fitted after installation !

The Fairford Standard Towel Hangers will add approx 8mm width on each side once fitted to the radiator.



Aluminium Range

FAIRFORD HORIZONTAL

Warranty 5 Year	Heating 	All Electric 	Dual-Fuel 
-------------------------------------	---	--	---



Pictured 89.0225 Matt Anthracite

This modern radiator has a curved front design that will provide a stylish warmth to any room. Available in two colours as well as horizontal and vertical designs.

Fairford Horizontal Aluminium Radiators - Matt White

Size H x W	Watts	BTU	Element Output	Element Type	Code	£ Ex VAT	£ Inc VAT
600 x 375mm	504	1718	N/A	N/A	89.0217	137.00	164.40
600 x 565mm	756	2578	300W	A or C	89.0218	194.00	232.80
600 x 945mm	1260	4296	600W	A or C	89.0219	319.00	382.80
600 x 1325mm	1764	6015	900W	A or C	89.0220	438.00	525.60

Fairford Horizontal Aluminium Radiators - Matt Anthracite

Size H x W	Watts	BTU	Element Output	Element Type	Code	£ Ex VAT	£ Inc VAT
600 x 375mm	504	1718	N/A	N/A	89.0223	137.00	164.40
600 x 565mm	756	2578	300W	A or C	89.0224	194.00	232.80
600 x 945mm	1260	4296	600W	A or C	89.0225	319.00	382.80
600 x 1325mm	1764	6015	900W	A or C	89.0226	438.00	525.60

Prices include radiator and wall fixing sets, valves and accessories extra.

FEATURES

- Excellent heat conductivity and lightweight.
 - Only requires a low water volume.
 - Heats up very quickly.
 - Radiators come with cover caps on top and bottom, same as radiator colour.
 - Manufactured and tested to EN442 standard.
 - CE Certification.
 - 5 Year Manufacturer's Warranty*
 - Can be single or dual fuel, or all electric.
- * With conditions

Round Vent Caps
Page 637



Aluminium Range

FAIRFORD HORIZONTAL



Pictured 89.0220 Matt White

FAIRFORD STANDARD TOWEL HANGERS



Towel Hanger - Matt White

Size	Code	£ Ex VAT	£ Inc VAT
375mm*	89.0318	32.00	38.40
565mm**	89.0319	39.00	46.80

Suitable 375mm width radiators only*

Suitable 565mm width radiators only**

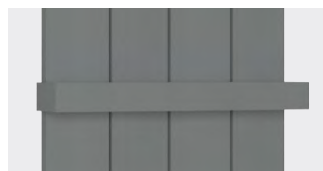

Towel Hanger - Matt Anthracite

Size	Code	£ Ex VAT	£ Inc VAT
375mm*	89.0320	32.00	38.40
565mm**	89.0321	39.00	46.80

Suitable 375mm width radiators only*

Suitable 565mm width radiators only**



Towel Hanger - Chrome

Size	Code	£ Ex VAT	£ Inc VAT
375mm*	89.0322	32.00	38.40
565mm**	89.0323	39.00	46.80

Suitable 375mm width radiators only*

Suitable 565mm width radiators only**

600mm height radiators comes with 1 pre-drilled towel hanger location, with a maximum of 1 towel hanger. (only 375 and 565mm widths)

The Standard Towel Hangers are compatible with the Horizontal radiators. (Depending on the radiators and hangers width)

Can be fitted after installation !

The Fairford Standard Towel Hangers will add approx 8mm width on each side once fitted to the radiator.



Fairford Cover Cap Set - Chrome

Description	Code	£ Ex VAT	£ Inc VAT
Cover Cap 375mm	89.0399	10.00	12.00
Cover Cap 565mm	89.0400	14.00	16.80
Cover Cap 945mm	89.0401	20.00	24.00
Cover Cap 1325mm	89.0402	28.00	33.60

Cover cap set only includes cover caps for the top or bottom of the radiator.

For element types see pages 628-629.

Element can only be installed horizontally on the bottom header. Radiators that are electric only are restricted to the heat output of the elements (Type C up to 900 watts).



TECHNICAL INFORMATION

All measurements in Height by Width. Heat output based on $\Delta T60^{\circ}\text{C}$. For matching valves see pages 630-634. Corrosion inhibitor must be added to the heating system and maintained. Flow diverter must only be fitted when radiator installed on central heating system. For indirect heating systems only. Tappings are the width of the rail and 33 or 53mm off the wall.

Aluminium Range

BURFORD VERTICAL

Pictured 89.0236 Matt White with 89.0342 Towel Hangers



This slimline radiator would be an ideal solution for those tight or tall spaces. This design has a curved front that will provide a stylish warmth to any room. Available in two colours as well as horizontal and vertical designs.

FEATURES

- Excellent heat conductivity and lightweight.
- Only requires a low water volume.
- Heats up very quickly.
- Radiators come with cover caps on top and bottom, same as radiator colour.
- Manufactured and tested to EN442 standard.
- CE Certification.
- 5 Year Manufacturer's Warranty*
- Can be single or dual fuel, or all electric.

* With conditions

For element types see pages 628-629.

Element can only be installed vertically on the right hand side. Radiators that are electric only are restricted to the heat output of the elements.



Round Vent Caps
Page 637

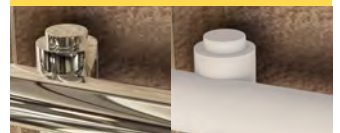

Warranty

5
Year

Heating



All Electric



Dual-Fuel



Aluminium Range

BURFORD VERTICAL

Pictured 89.0243 Matt Anthracite with 89.0335 Towel Hangers



Burford Vertical Aluminium Radiators - Matt White

Size H x W	Watts	BTU	Element Output	Element Type	Code	£ Ex VAT	£ Inc VAT
1800 x 275mm	1348	4597	600W	A	89.0234	259.00	310.80
1800 x 345mm	1685	5746	900W	A	89.0235	311.00	373.20
1800 x 415mm	2022	6895	900W	A	89.0236	369.00	442.80
1800 x 485mm	2359	8044	900W	A	89.0237	426.00	511.20

Burford Vertical Aluminium Radiators - Matt Anthracite

Size H x W	Watts	BTU	Element Output	Element Type	Code	£ Ex VAT	£ Inc VAT
1800 x 275mm	1348	4597	600W	A	89.0243	259.00	310.80
1800 x 345mm	1685	5746	900W	A	89.0244	311.00	373.20
1800 x 415mm	2022	6895	900W	A	89.0245	369.00	442.80
1800 x 485mm	2359	8044	900W	A	89.0246	426.00	511.20

Prices include radiator and wall fixing sets, valves and accessories extra.

TECHNICAL INFORMATION

All measurements in Height by Width. Heat output based on $\Delta T60^{\circ}\text{C}$. For matching valves see pages 630-634. Corrosion inhibitor must be added to the heating system and maintained. Flow diverter must only be fitted when radiator installed on central heating system. For indirect heating systems only. Tappings are the width of the rail and 33 or 53mm off the wall.



Burford Cover Caps - Chrome

Description	Code	£ Ex VAT	£ Inc VAT
Cover Cap 275mm	89.0403	11.00	13.20
Cover Cap 345mm	89.0404	13.00	15.60
Cover Cap 415mm	89.0405	15.00	18.00
Cover Cap 485mm	89.0406	16.00	19.20

Cover cap set only includes cover caps for the top or bottom of the radiator.

BURFORD STANDARD TOWEL HANGERS



Towel Hanger - Matt White

Size	Code	£ Ex VAT	£ Inc VAT
275mm	89.0330	31.00	37.20
345mm	89.0331	32.00	38.40
415mm	89.0332	35.00	42.00
485mm	89.0333	41.00	49.20



Towel Hanger - Matt Anthracite

Size	Code	£ Ex VAT	£ Inc VAT
275mm	89.0335	31.00	37.20
345mm	89.0336	32.00	38.40
415mm	89.0337	35.00	42.00
485mm	89.0338	41.00	49.20



Towel Hanger - Chrome

Size	Code	£ Ex VAT	£ Inc VAT
275mm	89.0340	31.00	37.20
345mm	89.0341	32.00	38.40
415mm	89.0342	35.00	42.00
485mm	89.0343	41.00	49.20

1800mm height radiators comes with 3 pre-drilled towel hanger locations, with a maximum of 3 towel hangers. (all widths; 275, 345, 415 and 485mm)

The Standard Towel Hangers are compatible with the Vertical radiators. (Depending on the radiators and hangers width)

Can be fitted after installation !

The Burford Standard Towel Hangers will add approx 50mm width on each side once fitted to the radiator.

Aluminium Range

BURFORD HORIZONTAL

Warranty

5

Year

Heating



All Electric



Dual-Fuel



Pictured 89.0230 Matt White with 89.0344 Towel Hanger

This modern radiator has a curved front design that will provide a stylish warmth to any room. Available in two colours as well as horizontal and vertical designs.

Burford Horizontal Aluminium Radiators - Matt White

Size H x W	Watts	BTU	Element Output	Element Type	Code	£ Ex VAT	£ Inc VAT
600 x 485mm	924	3150	300W	A or C	89.0229	220.00	264.00
600 x 625mm	1188	4051	300W	A or C	89.0230	275.00	330.00
600 x 835mm	1584	5401	600W	A or C	89.0231	365.00	438.00
600 x 1045mm	1980	6752	900W	A or C	89.0232	451.00	541.20
600 x 1185mm	2244	7652	900W	A or C	89.0233	504.00	604.80

Burford Horizontal Aluminium Radiators - Matt Anthracite

Size H x W	Watts	BTU	Element Output	Element Type	Code	£ Ex VAT	£ Inc VAT
600 x 485mm	924	3150	300W	A or C	89.0238	220.00	264.00
600 x 625mm	1188	4051	300W	A or C	89.0239	275.00	330.00
600 x 835mm	1584	5401	600W	A or C	89.0240	365.00	438.00
600 x 1045mm	1980	6752	900W	A or C	89.0241	451.00	541.20
600 x 1185mm	2244	7652	900W	A or C	89.0242	504.00	604.80

Prices include radiator and wall fixing sets, valves and accessories extra.

FEATURES

- Excellent heat conductivity and lightweight.
- Only requires a low water volume.
- Heats up very quickly.
- Radiators come with cover caps on top and bottom, same as radiator colour.
- Manufactured and tested to EN442 standard.
- CE Certification.
- 5 Year Manufacturer's Warranty*
- Can be single or dual fuel, or all electric.

* With conditions

Round Vent Caps

Page 637



Aluminium Range

BURFORD HORIZONTAL



Pictured 89.0241 Matt Anthracite

BURFORD STANDARD TOWEL HANGERS



Towel Hanger - Matt White

Size	Code	£ Ex VAT	£ Inc VAT
485mm*	89.0333	41.00	49.20
625mm**	89.0334	47.00	56.40

Suitable 485mm width radiators only*

Suitable 625mm width radiators only**

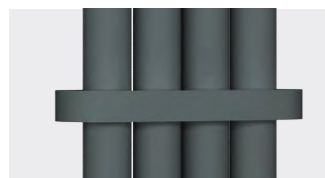

Towel Hanger - Matt Anthracite

Size	Code	£ Ex VAT	£ Inc VAT
485mm*	89.0338	41.00	49.20
625mm**	89.0339	47.00	56.40

Suitable 485mm width radiators only*

Suitable 625mm width radiators only**



Towel Hanger - Chrome

Size	Code	£ Ex VAT	£ Inc VAT
485mm*	89.0343	41.00	49.20
625mm**	89.0344	47.00	56.40

Suitable 485mm width radiators only*

Suitable 625mm width radiators only**

600mm height radiators comes with 1 pre-drilled towel hanger location, with a maximum of 1 towel hanger. (only 485 and 625mm widths)

The Standard Towel Hangers are compatible with the Horizontal radiators. (Depending on the radiators and hangers width)

Can be fitted after installation !

The Burford Standard Towel Hangers will add approx 50mm width on each side once fitted to the radiator.



Burford Cover Caps - Chrome

Description	Code	£ Ex VAT	£ Inc VAT
Cover Cap 485mm	89.0406	16.00	19.20
Cover Cap 625mm	89.0407	19.00	22.80
Cover Cap 835mm	89.0408	25.00	30.00
Cover Cap 1045mm	89.0409	29.00	34.80
Cover Cap 1185mm	89.0410	32.00	38.40

Cover cap set only includes cover caps for the top or bottom of the radiator.

For element types see pages 628-629.

Element can only be installed horizontally on the bottom header. Radiators that are electric only are restricted to the heat output of the elements (Type C up to 900 watts).



TECHNICAL INFORMATION

All measurements in Height by Width. Heat output based on $\Delta T60^{\circ}\text{C}$. For matching valves see pages 630-634. Corrosion inhibitor must be added to the heating system and maintained. Flow diverter must only be fitted when radiator installed on central heating system. For indirect heating systems only. Tappings are the width of the rail and 33 or 53mm off the wall.

Aluminium Range

KELMSCOTT VERTICAL

Pictured 89.0255 Matt White with 89.0358 Towel Hangers



This slimline radiator would be an ideal solution for those tight or tall spaces. This design has a curved front that will provide a stylish warmth to any room. Available in two colours as well as horizontal and vertical designs.

- FEATURES**
- Excellent heat conductivity and lightweight.
 - Only requires a low water volume.
 - Heats up very quickly.
 - Radiators come with cover caps on top and bottom, same as radiator colour.
 - Manufactured and tested to EN442 standard.
 - CE Certification.
 - 5 Year Manufacturer's Warranty*
 - Can be single or dual fuel, or all electric.
- * With conditions

For element types see pages 628-629.

Element can only be installed vertically on the right hand side. Radiators that are electric only are restricted to the heat output of the elements.

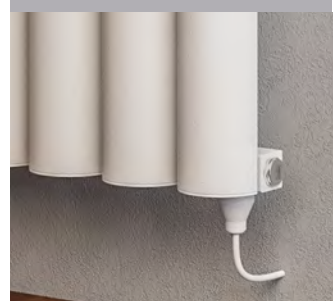

Round Vent Caps
Page 637

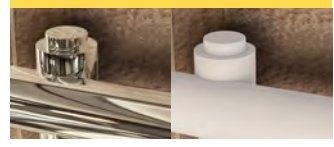

Warranty
5
Year

Heating

All Electric

Dual-Fuel

Aluminium Range

KELMSCOTT VERTICAL

Pictured 89.0262 Matt Anthracite with 89.0351 Towel Hangers

Kelmscott Vertical Aluminium Radiators - Matt White

Size H x W	Watts	BTU	Element Output	Element Type	Code	£ Ex VAT	£ Inc VAT
1800 x 275mm	1076	3669	600W	A	89.0252	248.00	297.60
1800 x 345mm	1345	4586	600W	A	89.0253	299.00	358.80
1800 x 415mm	1614	5504	900W	A	89.0254	354.00	424.80
1800 x 485mm	1883	6421	900W	A	89.0255	408.00	489.60

Kelmscott Vertical Aluminium Radiators - Matt Anthracite

Size H x W	Watts	BTU	Element Output	Element Type	Code	£ Ex VAT	£ Inc VAT
1800 x 275mm	1076	3669	600W	A	89.0261	248.00	297.60
1800 x 345mm	1345	4586	600W	A	89.0262	299.00	358.80
1800 x 415mm	1614	5504	900W	A	89.0263	354.00	424.80
1800 x 485mm	1883	6421	900W	A	89.0264	408.00	489.60

Prices include radiator and wall fixing sets, valves and accessories extra.

TECHNICAL INFORMATION

All measurements in Height by Width. Heat output based on $\Delta T60^{\circ}\text{C}$. For matching valves see pages 630-634. Corrosion inhibitor must be added to the heating system and maintained. Flow diverter must only be fitted when radiator installed on central heating system. For indirect heating systems only. Tappings are the width of the rail and 33 or 53mm off the wall.



Kelmscott Cover Cap Set - Chrome

Description	Code	£ Ex VAT	£ Inc VAT
Cover Cap 275mm	89.0411	10.00	12.00
Cover Cap 345mm	89.0412	12.00	14.40
Cover Cap 415mm	89.0413	13.00	15.60
Cover Cap 485mm	89.0414	15.00	18.00

Cover cap set only includes cover caps for the top or bottom of the radiator.

KELMSCOTT STANDARD TOWEL HANGERS



Towel Hanger - Matt White

Size	Code	£ Ex VAT	£ Inc VAT
275mm	89.0345	29.00	34.80
345mm	89.0346	30.00	36.00
415mm	89.0347	32.00	38.40
485mm	89.0348	38.00	45.60



Towel Hanger - Matt Anthracite

Size	Code	£ Ex VAT	£ Inc VAT
275mm	89.0350	29.00	34.80
345mm	89.0351	30.00	36.00
415mm	89.0352	32.00	38.40
485mm	89.0353	38.00	45.60



Towel Hanger - Chrome

Size	Code	£ Ex VAT	£ Inc VAT
275mm	89.0355	29.00	34.80
345mm	89.0356	30.00	36.00
415mm	89.0357	32.00	38.40
485mm	89.0358	38.00	45.60

1800mm height radiators comes with 3 pre-drilled towel hanger locations, with a maximum of 3 towel hangers. (all widths; 275, 345, 415 and 485mm)

The Standard Towel Hangers are only compatible with the Vertical radiators. (Depending on the radiators and hangers width)

Can be fitted after installation !

The Kelmscott Standard Towel Hangers will add approx 43mm width on each side once fitted to the radiator.



Aluminium Range

KELMSCOTT HORIZONTAL

Pictured 89.0257 Matt Anthracite with 89.0415 x 2 Cover Caps



Warranty

5

Year

Heating



All Electric



Dual-Fuel



This modern radiator has a curved front design that will provide a stylish warmth to any room. Available in two colours as well as horizontal and vertical designs.

KelmScott Horizontal Aluminium Radiators - Matt White

Size H x W	Watts	BTU	Element Output	Element Type	Code	£ Ex VAT	£ Inc VAT
600 x 485mm	735	2506	300W	A or C	89.0247	208.00	249.60
600 x 625mm	945	3222	300W	A or C	89.0248	263.00	315.60
600 x 835mm	1260	4297	600W	A or C	89.0249	350.00	420.00
600 x 1045mm	1575	5371	900W	A or C	89.0250	433.00	519.60
600 x 1185mm	1785	6087	900W	A or C	89.0251	485.00	582.00

KelmScott Horizontal Aluminium Radiators - Matt Anthracite

Size H x W	Watts	BTU	Element Output	Element Type	Code	£ Ex VAT	£ Inc VAT
600 x 485mm	735	2506	300W	A or C	89.0256	208.00	249.60
600 x 625mm	945	3222	300W	A or C	89.0257	263.00	315.60
600 x 835mm	1260	4297	600W	A or C	89.0258	350.00	420.00
600 x 1045mm	1575	5371	900W	A or C	89.0259	433.00	519.60
600 x 1185mm	1785	6087	900W	A or C	89.0260	485.00	582.00

Prices include radiator and wall fixing sets, valves and accessories extra.

FEATURES

- Excellent heat conductivity and lightweight.
 - Only requires a low water volume.
 - Heats up very quickly.
 - Radiators come with cover caps on top and bottom, same as radiator colour.
 - Manufactured and tested to EN442 standard.
 - CE Certification.
 - 5 Year Manufacturer's Warranty*
 - Can be single or dual fuel, or all electric.
- * With conditions

Round Vent Caps
Page 637



Aluminium Range

KELMSCOTT HORIZONTAL



Pictured 89.0250 Matt White

KELMSCOTT STANDARD TOWEL HANGERS



Towel Hanger - Matt White

Size	Code	£ Ex VAT	£ Inc VAT
485mm*	89.0348	38.00	45.60
625mm**	89.0349	44.00	52.80

Suitable 485mm width radiators only*

Suitable 625mm width radiators only**



Towel Hanger - Matt Anthracite

Size	Code	£ Ex VAT	£ Inc VAT
485mm*	89.0353	38.00	45.60
625mm**	89.0354	44.00	52.80

Suitable 485mm width radiators only*

Suitable 625mm width radiators only**



Towel Hanger - Chrome

Size	Code	£ Ex VAT	£ Inc VAT
485mm*	89.0358	38.00	45.60
625mm**	89.0359	44.00	52.80

Suitable 485mm width radiators only*

Suitable 625mm width radiators only**

600mm height radiators comes with 1 pre-drilled towel hanger location, with a maximum of 1 towel hanger. (only 485 and 625mm widths)

The Standard Towel Hangers are compatible with the Horizontal radiators. (Depending on the radiators and hangers width)

Can be fitted after installation !

The Kelmscott Standard Towel Hangers will add approx 43mm width on each side once fitted to the radiator.



Kelmscott Cover Caps - Chrome

Description	Code	£ Ex VAT	£ Inc VAT
Cover Cap 485mm	89.0414	15.00	18.00
Cover Cap 625mm	89.0415	18.00	21.60
Cover Cap 835mm	89.0416	23.00	27.60
Cover Cap 1045mm	89.0417	27.00	32.40
Cover Cap 1185mm	89.0418	29.00	34.80

Cover cap set only includes cover caps for the top or bottom of the radiator.

For element types see pages 628-629.

Element can only be installed horizontally on the bottom header. Radiators that are electric only are restricted to the heat output of the elements (Type C up to 900 watts).



TECHNICAL INFORMATION

All measurements in Height by Width. Heat output based on $\Delta T60^{\circ}\text{C}$. For matching valves see pages 630-634. Corrosion inhibitor must be added to the heating system and maintained. Flow diverter must only be fitted when radiator installed on central heating system. For indirect heating systems only. Tappings are the width of the rail and 33 or 53mm off the wall.

Aluminium Range

WITNEY VERTICAL

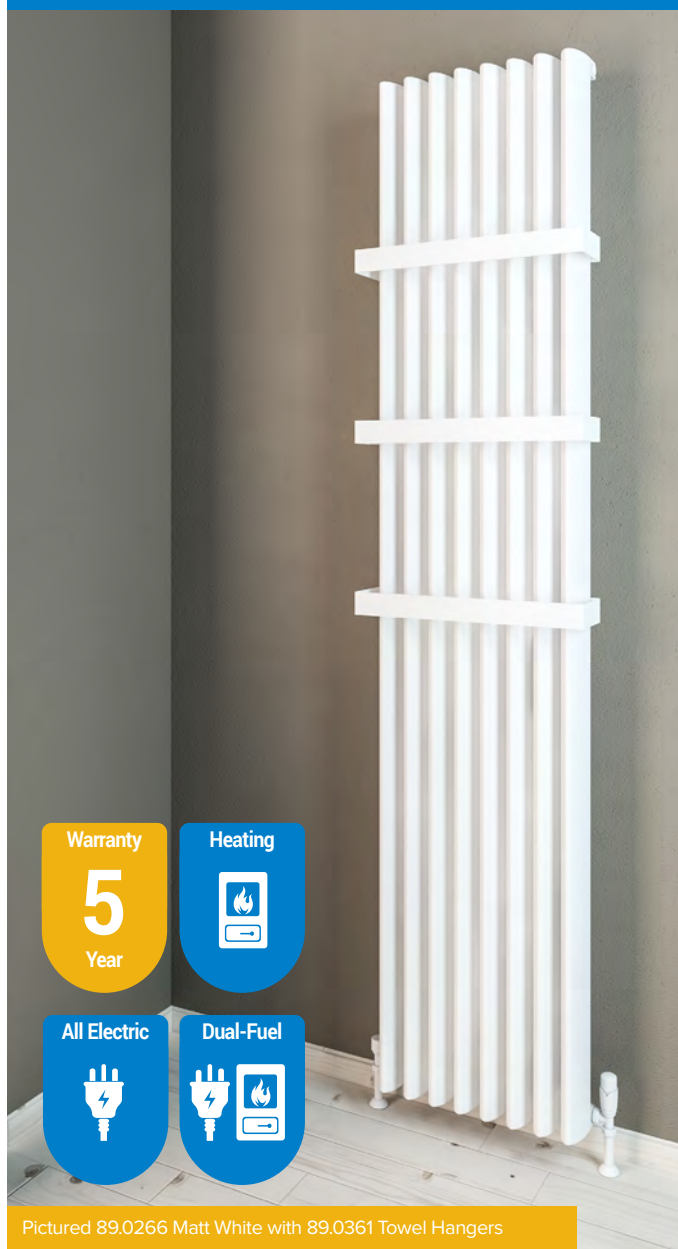

Warranty
5
Year

Heating

All Electric

Dual-Fuel

Pictured 89.0266 Matt White with 89.0361 Towel Hangers

A high heat capacity radiator ideal for those situations where space is at a minimum. Available in two finishes.

Witney Vertical Aluminium Radiators - Matt White

Size H x W	Watts	BTU	Element Output	Element Type	Code	£ Ex VAT	£ Inc VAT
1800 x 280mm	1824	6219	900W	A	89.0265	352.00	422.40
1800 x 375mm	2432	8293	900W	A	89.0266	464.00	556.80
1800 x 470mm	3040	10366	900W	A	89.0267	558.00	669.60

Witney Vertical Aluminium Radiators - Matt Anthracite

Size H x W	Watts	BTU	Element Output	Element Type	Code	£ Ex VAT	£ Inc VAT
1800 x 280mm	1824	6219	900W	A	89.0268	352.00	422.40
1800 x 375mm	2432	8293	900W	A	89.0269	464.00	556.80
1800 x 470mm	3040	10366	900W	A	89.0270	558.00	669.60

Prices include radiator and wall fixing sets, valves and accessories extra.

FEATURES

- Excellent heat conductivity and lightweight.
 - Only requires a low water volume.
 - Heats up very quickly.
 - Radiators come with cover caps on top and bottom, same as radiator colour.
 - Manufactured and tested to EN442 standard.
 - CE Certification.
 - 5 Year Manufacturer's Warranty*
 - Can be single or dual fuel, or all electric.
- * With conditions

TECHNICAL INFORMATION

All measurements in Height by Width. Heat output based on $\Delta T60^{\circ}C$. For matching valves see pages 630-634. Corrosion inhibitor must be added to the heating system and maintained. Flow diverter must only be fitted when radiator installed on central heating system. For indirect heating systems only. Tappings are the width of the rail and 53mm off the wall.



Witney Cover Cap Set - Chrome

Description	Code	£ Ex VAT	£ Inc VAT
Cover Cap 280mm	89.0419	16.00	19.20
Cover Cap 375mm	89.0420	21.00	25.20
Cover Cap 470mm	89.0421	26.00	31.20

Cover cap set only includes cover caps for the top or bottom of the radiator.

For element types see pages 628-629.

Element can only be installed vertically on the right hand side. Radiators that are electric only are restricted to the heat output of the elements.



WITNEY STANDARD TOWEL HANGERS



Towel Hanger - Matt White

Size	Code	£ Ex VAT	£ Inc VAT
280mm	89.0360	34.00	40.80
375mm	89.0361	37.00	44.40
470mm	89.0362	42.00	50.40



Towel Hanger - Matt Anthracite

Size	Code	£ Ex VAT	£ Inc VAT
280mm	89.0363	34.00	40.80
375mm	89.0364	37.00	44.40
470mm	89.0365	42.00	50.40



Towel Hanger - Chrome

Size	Code	£ Ex VAT	£ Inc VAT
280mm	89.0366	34.00	40.80
375mm	89.0367	37.00	44.40
470mm	89.0368	42.00	50.40

1800mm height radiators comes with 3 pre-drilled towel hanger locations, with a maximum of 3 towel hangers. (all widths; 280, 375 and 470mm)

Can be fitted after installation !

The Witney Towel Hangers will add approx 8mm width on each side once fitted to the radiator.

Round Vent Caps

Page 637



Stainless Steel Range

RIZANO



This sophisticated, ultra modern radiator adds a hugely useful feature with its single sided towel bars.

Rizano - Stainless Steel Polished

Size H x W	Watts	BTU	Element Output	Element Type	Code	£ Ex VAT	£ Inc VAT
1000 x 500mm	545	1859	300W	A, D or E	41.0250	384.00	460.80
1000 x 600mm	626	2136	300W	A, D or E	41.0251	528.00	633.60

FEATURES

- Grade 304 Stainless Steel material.
- Mirror polished surface (Chrome effect).
- Can be single, dual fuel or all electric.
- Manufactured and tested to EN442 standard.
- CE & NF Certification.
- 5 Year Manufacturer's Warranty*
- * With conditions

TECHNICAL INFORMATION

All measurements in Height by Width. Heat output based on $\Delta T60^{\circ}\text{C}$. Radiators that are electric only are restricted to the heat output of the elements. Element size can be increased to full capacity of rail if using element type D or E. For element type see pages 628-629. For matching valves see pages 630-634. For direct & indirect heating systems. Tappings are approx. 50mm and approx. 58mm off the wall. Price includes radiator and wall fixing sets, valves extra. Maximum working temperature: 4 bars.

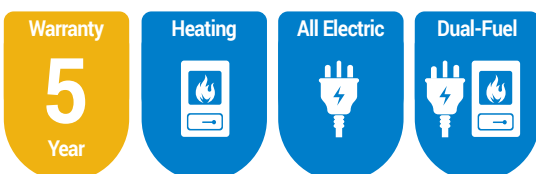

ASCONA



This sophisticated, ultra modern radiator adds a hugely useful feature with its single sided towel bars.

Ascona - Stainless Steel Polished

Size H x W	Watts	BTU	Element Output	Element Type	Code	£ Ex VAT	£ Inc VAT
420 x 500mm	280	955	150W	A or E	41.0254	299.00	358.80

FEATURES

- Grade 304 Stainless Steel material.
- Mirror polished surface (Chrome effect).
- Can be single, dual fuel or all electric.
- Manufactured and tested to EN442 standard.
- CE & NF Certification.
- 5 Year Manufacturer's Warranty*
- * With conditions

TECHNICAL INFORMATION

All measurements in Height by Width. Heat output based on $\Delta T60^{\circ}\text{C}$. Radiators that are electric only are restricted to the heat output of the elements. Element size can be increased to full capacity of rail if using element type E. For element type see pages 628-629. For matching valves see pages 630-634. For direct & indirect heating systems. Tappings are approx. 60mm less than the width of the rail and approx. 58mm off the wall. Price includes radiator and wall fixing sets, valves extra. Maximum working temperature: 4 bars.

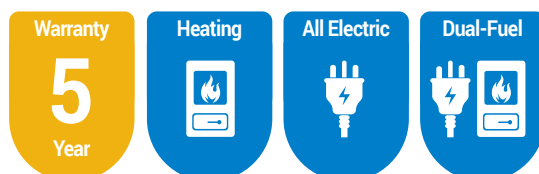

Stainless Steel Range

BIAVA FLAT

Pictured 41.0253 Polished



Whilst retaining the features of a ladder rail this flat panelled radiator produces a stylish and contemporary look. The larger surface area of the flat panels allow for a higher heat output with no compromise on design.

Biava Flat - Stainless Steel Polished

Size H x W	Watts	BTU	Element Output	Element Type	Code	£ Ex VAT	£ Inc VAT
1170 x 500mm	621	2119	300W	A, D or E	41.0252	437.00	524.40
1170 x 600mm	712	2429	300W	A, D or E	41.02	476.00	571.20

FEATURES

- Grade 304 Stainless Steel material.
 - Mirror polished surface (Chrome effect).
 - Can be single, dual fuel or all electric.
 - Manufactured and tested to EN442 standard.
 - CE & NF Certification.
 - 5 Year Manufacturer's Warranty*
- * With conditions

TECHNICAL INFORMATION

All measurements in Height by Width. Heat output based on $\Delta T60^{\circ}\text{C}$. Radiators that are electric only are restricted to the heat output of the elements. Element size can be increased to full capacity of rail if using element type D or E. For element types see pages 628-629. For matching valves see pages 630-634. For direct & indirect heating systems. Tappings are approx. 80mm less than the width of the rail and approx. 58mm off the wall. Prices include radiator and wall fixings sets, valves extra. Maximum working temperature: 4 bars.

Warranty

5
Year

Heating



All Electric



Dual-Fuel



Stainless Steel Range

VIOLLA

Pictured 87.0001 Polished



Warranty

5
Year

Heating



All Electric



Dual-Fuel



Pictured 87.0005 Polished

FEATURES

- Grade 304 Stainless Steel material.
 - Mirror polished surface (Chrome effect).
 - Can be single, dual fuel or all electric.
 - Manufactured and tested to EN442 standard.
 - CE & NF Certification.
 - 5 Year Manufacturer's Warranty*
- * With conditions

A take on the simple ladder rail design this radiator is both functional and minimalist. Rail spacing makes it easy to put a towel on all of the bars, making it the perfect family bathroom solution.

Violla - Stainless Steel Polished

Size H x W	Watts	BTU	Element Output	Element Type	Code	£ Ex VAT	£ Inc VAT
590 x 1000mm	231	788	150W	A, D or E	87.0001	236.00	283.20
790 x 500mm	199	679	100W	A, D or E	87.0002	231.00	277.20
790 x 600mm	226	771	150W	A, D or E	87.0003	245.00	294.00
1210 x 500mm	320	1092	150W	A, D or E	87.0004	261.00	313.20
1210 x 600mm	366	1249	150W	A, D or E	87.0005	273.00	327.60
1630 x 500mm	416	1419	300W	A, D or E	87.0006	341.00	409.20
1630 x 600mm	474	1617	300W	A, D or E	87.0007	404.00	484.80

TECHNICAL INFORMATION

All measurements in Height by Width. Heat output based on $\Delta T60^{\circ}\text{C}$. Radiators that are electric only are restricted to the heat output of the elements. Element size can be increased to full capacity of rail if using element type D or E. For element types see pages 628-629. For matching valves see pages 630-634. For direct & indirect heating systems. Tappings are approx. 32mm less than the width of the rail and approx. 79mm off the wall. Prices include radiator and wall fixings sets, valves extra. Maximum working temperature: 4 bars.

Traditonal Range

WINDRUSH

Pictured 41.1009

Warranty

5

Year

Heating



All Electric



Dual-Fuel





Pictured 41.1016



Pictured 41.1014



Our traditional range of radiators offer character and flair to ensure they fit in with your classic designs. The Windrush is a simple, traditional design that will add a vintage feel to your bathroom.

Windrush - Chrome								
Size H x W x D	Watts	BTU	Element Output	Element Type	Code	£ Ex VAT	£ Inc VAT	
950 x 500 x 130mm	147	502	100W	A or E	41.1009	193.00	231.60	
950 x 600 x 130mm	163	556	100W	A or E	41.1003	205.00	246.00	
1195 x 500 x 130mm	236	805	150W	A or E	41.1014	207.00	248.40	
1195 x 600 x 130mm	258	880	150W	A or E	41.1015	220.00	264.00	
1550 x 500 x 130mm	290	989	150W	A or E	41.1016	252.00	302.40	
1550 x 600 x 130mm	322	1099	150W	A or E	41.1017	263.00	315.60	

- FEATURES**
- Can be single, dual fuel or all electric.
 - Manufactured and tested to EN442 standard.
 - CE & NF Certification.
 - 5 Year Manufacturer's Warranty*
- * With conditions

TECHNICAL INFORMATION

All measurements in Height by Width. Heat output based on $\Delta T60^{\circ}C$. Radiators that are electric only are restricted to the heat output of the elements. Element size can be increased to full capacity of rail if using element type E. For element type see pages 628-629. For matching valves see pages 630-634. For indirect heating systems only. Tappings are approx. 130mm less than the width of the rail (144mm for 41.1009) and approx. 105mm off the wall. Price includes radiator and wall fixing sets, valves extra.

Traditonal Range

STOUR

Pictured 41.1018



Pictured 41.1020

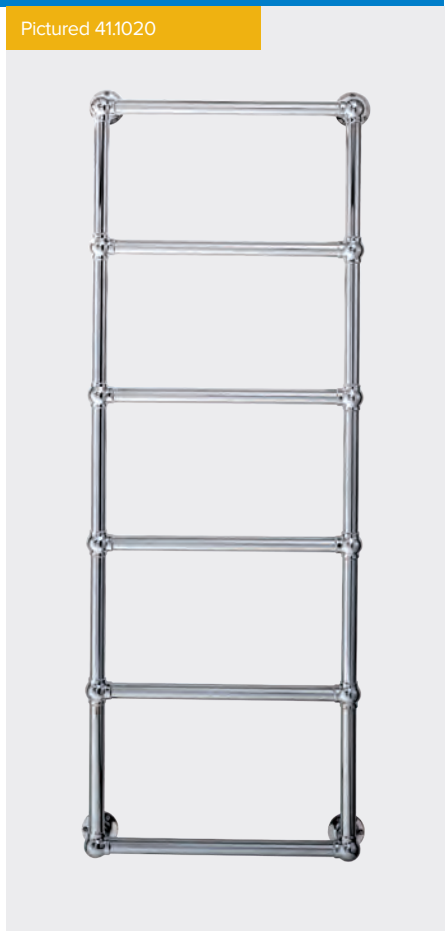

Pictured 41.1010



Warranty

5

Year

Heating



All Electric



Dual-Fuel



Our traditional range of radiators offer character and flair to ensure they fit in with your classic designs. The Stour offers a Victorian feel to complement a traditional bathroom.

Stour - Chrome

Size H x W x D	Watts	BTU	Element Output	Element Type	Code	£ Ex VAT	£ Inc VAT
690 x 500 x 125mm	125	428	100W	A or E	41.1010	144.00	172.80
690 x 600 x 125mm	177	604	100W	A or E	41.1005	158.00	189.60
1195 x 500 x 125mm	209	714	100W	A or E	41.1018	228.00	273.60
1195 x 600 x 125mm	232	791	150W	A or E	41.1019	239.00	286.80
1550 x 500 x 125mm	260	888	150W	A or E	41.1020	268.00	321.60
1550 x 600 x 125mm	287	980	150W	A or E	41.1021	287.00	344.40

FEATURES

- Can be single, dual fuel or all electric.
- Manufactured and tested to EN442 standard.
- CE & NF Certification.
- 5 Year Manufacturer's Warranty*

* With conditions

TECHNICAL INFORMATION

All measurements in Height by Width. Heat output based on $\Delta T60^{\circ}\text{C}$. Radiators that are electric only are restricted to the heat output of the elements. Element size can be increased to full capacity of rail if using element type E. For element type see pages 628-629. For matching valves see pages 630-634. For indirect heating systems only. Tappings are approx. 74mm less than the width of the rail and approx. 53mm off the wall. Price includes radiator and wall fixing sets, valves extra.

Traditonal Range

PAINSWICK

Pictured 41.1022



Warranty

5
Year

Heating



Our traditional range of radiators offer character and flair to ensure they fit in with your classic designs. The Painswick is a stunning classical radiator with elegant practical curves.

Painswick

Size H x W	Watts	BTU	Element Output	Element Type	Code	£ Ex VAT	£ Inc VAT
778 x 686mm	356	1215	N/A	N/A	41.1022	516.00	619.20

FEATURES

- Manufactured and tested to EN442 standard.
- CE & NF Certification.
- 5 Year Manufacturer's Warranty*
- Not suitable for elements.

* With conditions

TECHNICAL INFORMATION

All measurements in Height by Width. Heat output based on ▲T60°C. For matching valves see pages 630-634. For indirect heating systems only. Tappings are approx. 130mm less than the width of the rail and approx. 100mm off the floor. Price includes radiator and wall fixing sets, valves extra.



Pair of Radiator Valves & Tails

Code	£ Ex VAT	£ Inc VAT
41.3009	45.00	54.00

Radiator valves sold separately

Traditonal Range

FROME

For element types see pages 628-629.



Our traditional range of radiators offer character and flair to ensure they fit in with your classic designs. These rails only be used on closed or indirect heating circuits, not on fresh water hot systems as they are of steel construction.

Frome - Chrome

Size H x W	Watts	BTU	Element Output	Element Type	Code	£ Ex VAT	£ Inc VAT
940 x 474mm	314	1071	150W	A, C or E	41.1013	263.00	315.60

Tappings are approx. 130mm less than the width of the rail and approx. 105mm off the wall.

FEATURES

- Manufactured and tested to EN442 standard.
- 5 Year Manufacturer's Warranty.
- Can be single or dual fuel, or all electric.
- CE and NF Certificates
- * With conditions

TECHNICAL INFORMATION

All measurements in Height by Width. Heat output based on $\Delta T60^{\circ}C$. Radiators that are electric only are restricted to the heat output of the elements. Element size can be increased to full capacity of rail if using element type C or E. For element types see pages 628-629. For matching valves see pages 630-634. For indirect heating systems. Prices include radiator and wall fixings sets, valves extra.

Warranty

5

Year

Heating

All Electric

Dual-Fuel

Pair of Radiator Valves & Tails		
Code	£ Ex VAT	£ Inc VAT
41.3009	45.00	54.00

Radiator valves sold separately

AMPNEY

For element types see pages 628-629.



Our traditional range of radiators offer character and flair to ensure they fit in with your classic designs. These rails only be used on closed or indirect heating circuits, not on fresh water hot systems as they are of steel construction.

Ampney - Chrome

Size H x W	Watts	BTU	Element Output	Element Type	Code	£ Ex VAT	£ Inc VAT
940 x 674mm	423	1443	150W	A, C or E	41.1012	298.00	357.60

Tappings are approx. 130mm less than the width of the rail and approx. 105mm off the wall.

FEATURES

- Manufactured and tested to EN442 standard.
- 5 Year Manufacturer's Warranty.
- Can be single or dual fuel, or all electric.
- CE and NF Certificates
- * With conditions

TECHNICAL INFORMATION

All measurements in Height by Width. Heat output based on $\Delta T60^{\circ}C$. Radiators that are electric only are restricted to the heat output of the elements. Element size can be increased to full capacity of rail if using element type C or E. For element types see pages 628-629. For matching valves see pages 630-634. For indirect heating systems. Prices include radiator and wall fixings sets, valves extra.

Warranty

5

Year

Heating

All Electric

Dual-Fuel

Pair of Radiator Valves & Tails		
Code	£ Ex VAT	£ Inc VAT
41.3009	45.00	54.00

Radiator valves sold separately

Traditonal Range

SHERBOURNE



For element types see pages 628-629.

SEVERN



For element types see pages 628-629.

Our traditional range of radiators offer character and flair to ensure they fit in with your classic designs. These rails only be used on closed or indirect heating circuits, not on fresh water hot systems as they are of steel construction.

Sherbourne - Chrome							
Size H x W x D	Watts	BTU	Element Output	Element Type	Code	£ Ex VAT	£ Inc VAT
940 x 600 x 142mm	226	771	150W	A, C or E	41.1001	250.00	300.00

Tappings are approx. 130mm less than the width of the rail and approx. 105mm off the wall.

FEATURES

- Manufactured and tested to EN442 standard.
- 5 Year Manufacturer's Warranty.
- Can be single or dual fuel, or all electric.
- CE and NF Certificates
- * With conditions

TECHNICAL INFORMATION

All measurements in Height by Width. Heat output based on $\Delta T60^{\circ}\text{C}$. Radiators that are electric only are restricted to the heat output of the elements. Element size can be increased to full capacity of rail if using element type C or E. For element types see pages 628-629. For matching valves see pages 630-634. For indirect heating systems. Prices include radiator and wall fixings sets, valves extra.

Warranty

5

Year

Heating

All Electric

Dual-Fuel

Pair of Radiator Valves & Tails		
Code	£ Ex VAT	£ Inc VAT
41.3009	45.00	54.00

Radiator valves sold separately

Our traditional range of radiators offer character and flair to ensure they fit in with your classic designs. These rails only be used on closed or indirect heating circuits, not on fresh water hot systems as they are of steel construction.

Sherbourne - Chrome							
Size H x W x D	Watts	BTU	Element Output	Element Type	Code	£ Ex VAT	£ Inc VAT
1340 x 600 x 260mm	375	1278	300W	A, C or E	12.009	327.00	392.40

Tappings are approx. 130mm less than the width of the rail and approx. 130mm off the wall.

FEATURES

- Manufactured and tested to EN442 standard.
- 5 Year Manufacturer's Warranty.
- Can be single or dual fuel, or all electric.
- CE and NF Certificates
- * With conditions

TECHNICAL INFORMATION

All measurements in Height by Width. Heat output based on $\Delta T60^{\circ}\text{C}$. Radiators that are electric only are restricted to the heat output of the elements. Element size can be increased to full capacity of rail if using element type C or E. For element types see pages 628-629. For matching valves see pages 630-634. For indirect heating systems. Prices include radiator and wall fixings sets, valves extra.

Warranty

5

Year

Heating

All Electric

Dual-Fuel

Pair of Radiator Valves & Tails		
Code	£ Ex VAT	£ Inc VAT
41.3009	45.00	54.00

Radiator valves sold separately

Traditonal Range

ISBOURNE

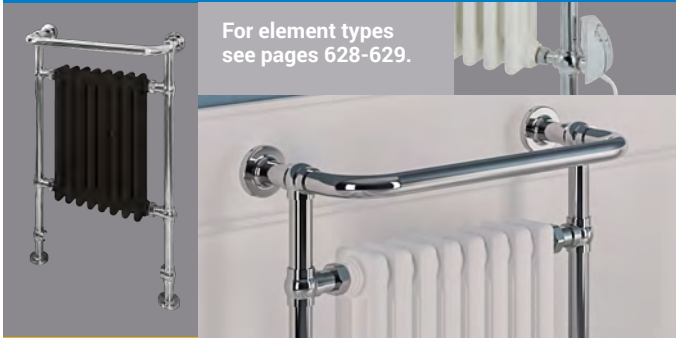

For element types see pages 628-629.

Pictured 41.1023

Pictured 41.1000 Chrome / White

Our traditional range of radiators offer character and flair to ensure they fit in with your classic designs. These rails only be used on closed or indirect heating circuits, not on fresh water hot systems as they are of steel construction.

Isbourne - Chrome / White							
Size H x W x D	Watts	BTU	Element Output	Element Type	Code	£ Ex VAT	£ Inc VAT
940 x 600 x 260mm	894	3050	300W	A, C or E	41.1000	285.00	342.00

Isbourne - Chrome / Black							
Size H x W x D	Watts	BTU	Element Output	Element Type	Code	£ Ex VAT	£ Inc VAT
940 x 600 x 260mm	894	3050	300W	A, C or E	41.1023	285.00	342.00

Tappings are approx. 130mm less than the width of the rail and approx. 121mm off the wall.

FEATURES

- Manufactured and tested to EN442 standard.
- 5 Year Manufacturer's Warranty.
- Can be single or dual fuel, or all electric.
- CE and NF Certificates
- * With conditions

TECHNICAL INFORMATION

All measurements in Height by Width. Heat output based on $\Delta T60^{\circ}C$. Radiators that are electric only are restricted to the heat output of the elements. Element size can be increased to full capacity of rail if using element type C or E. For element types see pages 628-629. For matching valves see pages 630-634. For indirect heating systems. Prices include radiator and wall fixings sets, valves extra.

Warranty

5

Year

Heating

All Electric

Dual-Fuel

Pair of Radiator Valves & Tails		
Code	£ Ex VAT	£ Inc VAT
41.3009	45.00	54.00

Radiator valves sold separately

AVON

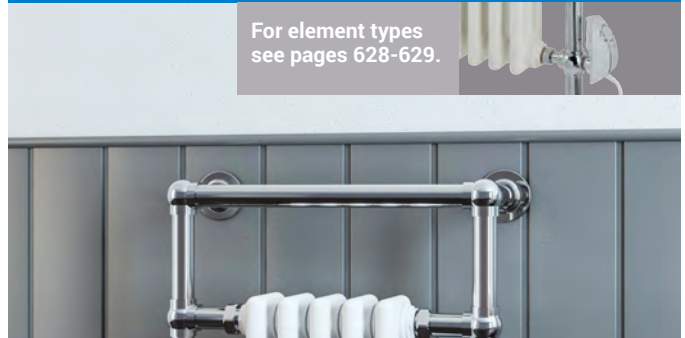

For element types see pages 628-629.



Our traditional range of radiators offer character and flair to ensure they fit in with your classic designs. These rails only be used on closed or indirect heating circuits, not on fresh water hot systems as they are of steel construction.

Avon - Chrome / White							
Size H x W x D	Watts	BTU	Element Output	Element Type	Code	£ Ex VAT	£ Inc VAT
960 x 500 x 185mm	530	1808	A, C or E	A, C or E	41.1006	243.00	291.60

Tappings are approx. 130mm less than the width of the rail and approx. 135mm off the wall.

FEATURES

- Manufactured and tested to EN442 standard.
- 5 Year Manufacturer's Warranty.
- Can be single or dual fuel, or all electric.
- CE and NF Certificates
- * With conditions

TECHNICAL INFORMATION

All measurements in Height by Width. Heat output based on $\Delta T60^{\circ}C$. Radiators that are electric only are restricted to the heat output of the elements. Element size can be increased to full capacity of rail if using element type C or E. For element types see pages 628-629. For matching valves see pages 630-634. For indirect heating systems. Prices include radiator and wall fixings sets, valves extra.

Warranty

5

Year

Heating

All Electric

Dual-Fuel

Pair of Radiator Valves & Tails		
Code	£ Ex VAT	£ Inc VAT
41.3009	45.00	54.00

Radiator valves sold separately

Traditonal Range

RIVASSA 2 COLUMN

Pictured 81.0003 Gloss White



A traditional rail which will give a Victorian touch of authenticity to any room but will also create an elegant look to a contemporary interior. This radiator boasts high outputs to ensure the whole room is warm. Comes with the option of traditional legs and in white or matt anthracite finishes. Also available in three columns.

FEATURES

- Manufactured and tested to EN442 standard.
 - 5 Year Manufacturer's Warranty.
 - CE Certification.
 - 300mm height option for limited spaces.
 - Matching colour wall fixing sets.
 - Radiator feet option available to get the classic look.
 - Material thickness 1.5mm
 - Doesn't require flow diverter.
- * With conditions

Warranty

5
Year

Heating



All Electric



Dual-Fuel

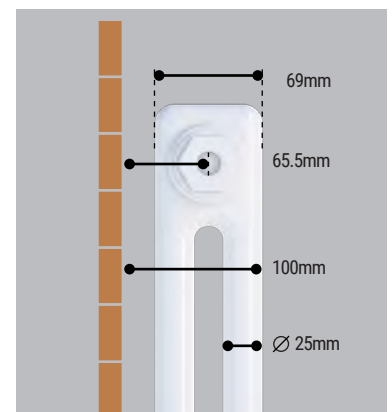

Traditonal Range

RIVASSA 2 COLUMN

RIVASSA 2 COLUMN - WIDTHS

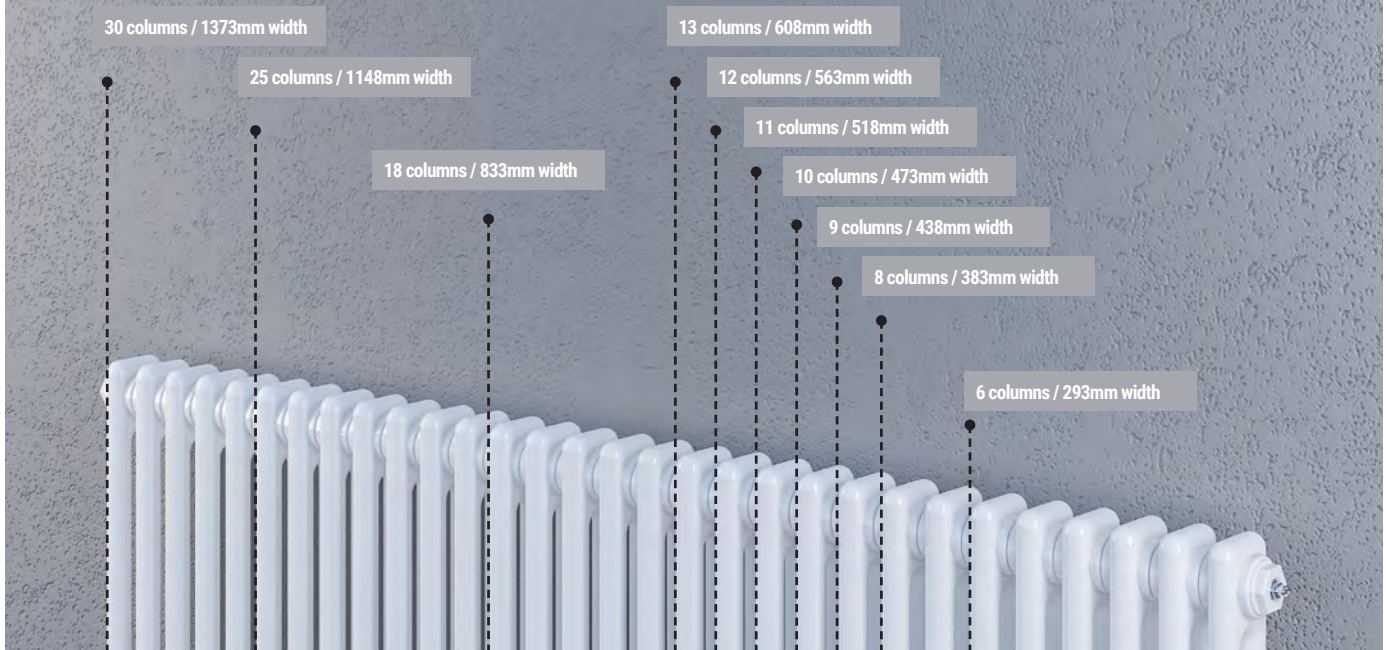

Rivassa Two Column Radiators - Gloss White

Size H x W	Watts	BTU	Element Output	Element Type	Code	£ Ex VAT	£ Inc VAT
300 x 1148mm	889	3034	600W	A, C or E*	81.0005	283.00	339.60
300 x 1373mm	1067	3641	600W	A, C or E*	81.0006	340.00	408.00
600 x 428mm	567	1933	300W	C	81.0038	129.00	154.80
600 x 473mm	630	2148	300W	A or C	81.0039	142.00	170.40
600 x 518mm	693	2362	300W	A or C	81.0040	157.00	188.40
600 x 563mm	756	2577	300W	A or C	81.0041	171.00	205.20
600 x 608mm	818	2792	300W	A, C or E*	81.0007	188.00	225.60
600 x 833mm	1133	3866	600W	A, C or E*	81.0008	260.00	312.00
600 x 1148mm	1573	5369	900W	A or C	81.0009	361.00	433.20
1800 x 293mm	933	3185	N/A	N/A	81.0002	167.00	200.40
1800 x 383mm	1245	4247	N/A	N/A	81.0003	222.00	266.40
1800 x 473mm	1556	5308	N/A	N/A	81.0004	278.00	333.60

*600w Type E Element can be fitted

Rivassa Two Column Radiators - Matt Anthracite

Size H x W	Watts	BTU	Element Output	Element Type	Code	£ Ex VAT	£ Inc VAT
300 x 1148mm	889	3034	600W	A, C or E*	81.0021	289.00	346.80
300 x 1373mm	1067	3641	600W	A, C or E*	81.0022	347.00	416.40
600 x 428mm	567	1933	300W	C	81.0046	131.00	157.20
600 x 473mm	630	2148	300W	A or C	81.0047	145.00	174.00
600 x 518mm	693	2362	300W	A or C	81.0048	160.00	192.00
600 x 563mm	756	2577	300W	A or C	81.0049	175.00	210.00
600 x 608mm	818	2792	300W	A, C or E*	81.0023	193.00	231.60
600 x 833mm	1133	3866	600W	A, C or E*	81.0024	265.00	318.00
600 x 1148mm	1573	5369	900W	A or C	81.0025	368.00	441.60
1800 x 293mm	933	3185	N/A	N/A	81.0018	171.00	205.20
1800 x 383mm	1245	4247	N/A	N/A	81.0019	226.00	271.20
1800 x 473mm	1556	5308	N/A	N/A	81.0020	283.00	339.60

*600w Type E Element can be fitted

TECHNICAL INFORMATION

All measurements in Height by Width. Heat output based on $\Delta T60^{\circ}\text{C}$. Radiators that are electric only are restricted to the heat output of the elements. Element size can be increased to full capacity of rail if using element type C or E. For element types see pages 628-629. For matching valves see pages 630-634. For indirect heating systems. Tappings are the width of the rail and 65.5mm off the wall. Prices include radiator and wall fixings sets, valves extra.

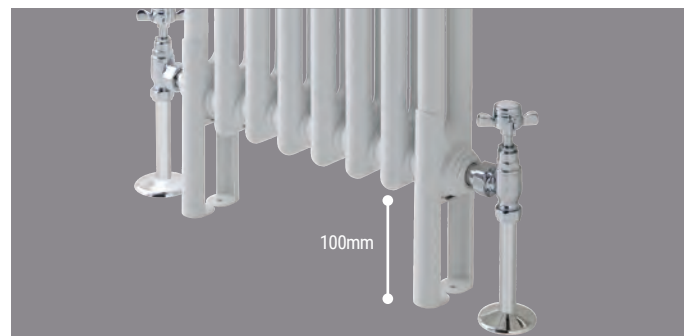

Rivassa Radiator Feet

Description	Code	£ Ex VAT	£ Inc VAT
Rivassa 2 Column Radiator Feet (pair) White	81.0034	20.00	24.00
Rivassa 2 Column Rad. Feet (pair) Matt Anthracite	81.0035	20.00	24.00



Pictured 81.0049 Matt Anthracite with 16.158 Towel Hanger

Towel Hangers

Page 636



Robe Hooks

Page 636



Round Vent Caps

Page 637



Traditonal Range

RIVASSA 3 COLUMN

Pictured 81.0032 Matt Anthracite with 81.0037



A traditional rail which will give a Victorian touch of authenticity to any room but will also create an elegant look to a contemporary interior. This radiator boasts high outputs to ensure the whole room is warm. Comes with the option of traditional legs and in white or matt anthracite finishes. Also available in two columns.

FEATURES

- Manufactured and tested to EN442 standard.
- 5 Year Manufacturer's Warranty.
- CE Certification.
- 300mm height option for limited spaces.
- Matching colour wall fixing sets.
- Radiator feet option available to get the classic look.
- Material thickness 1.5mm
- Doesn't require flow diverter.

* With conditions

Warranty

5
Year

Heating



All Electric



Dual-Fuel

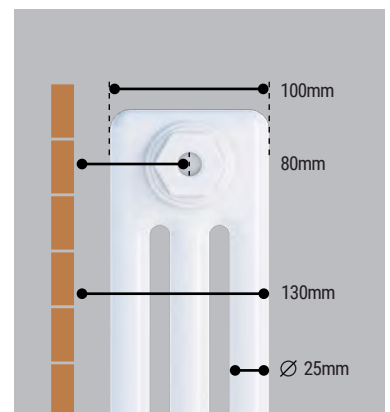

Traditonal Range

RIVASSA 3 COLUMN

RIVASSA 3 COLUMN - WIDTHS

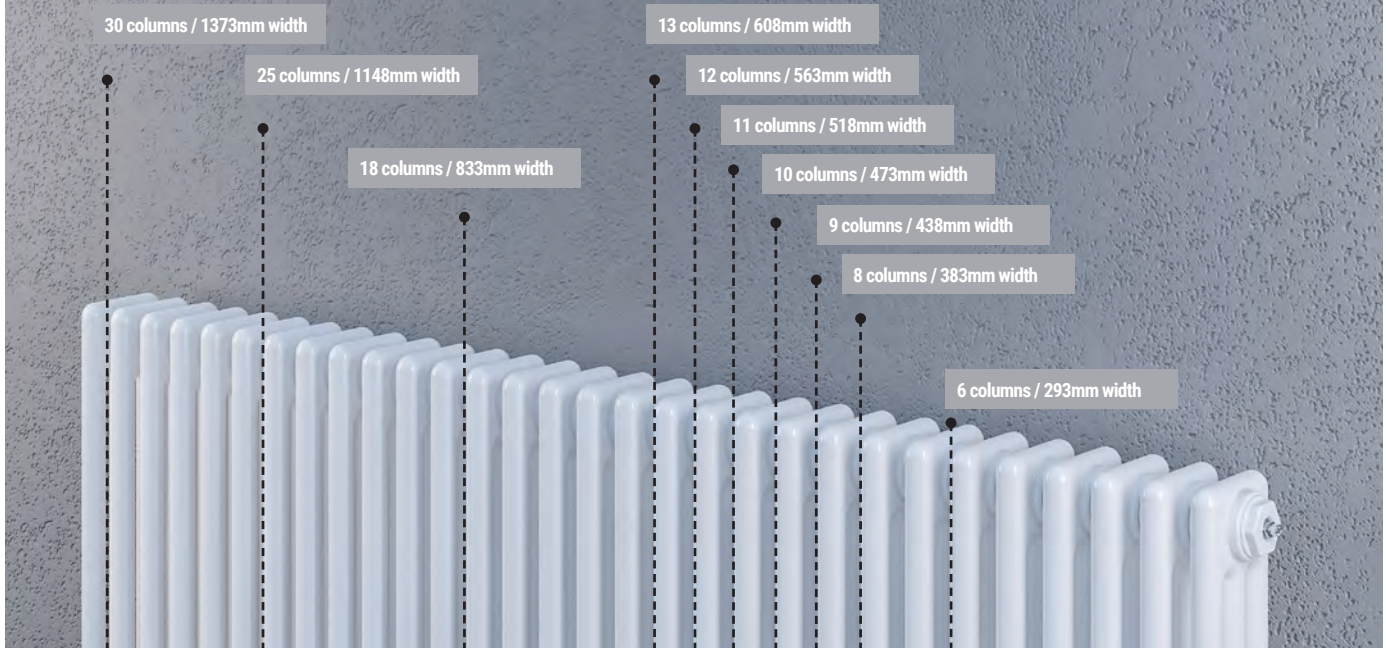

Rivassa Three Column Radiators - White

Size H x W	Watts	BTU	Element Output	Element Type	Code	£ Ex VAT	£ Inc VAT
300 x 1148mm	1118	3816	600W	A, C or E*	81.0013	301.00	361.20
300 x 1373mm	1342	4579	900W	A, C or E*	81.0014	361.00	433.20
600 x 428mm	734	2504	300W	C	81.0042	136.00	163.20
600 x 473mm	816	2782	300W	A or C	81.0043	151.00	181.20
600 x 518mm	898	3061	300W	A or C	81.0044	166.00	199.20
600 x 563mm	979	3339	300W	A or C	81.0045	181.00	217.20
600 x 608mm	1060	3616	600W	A or C	81.0015	199.00	238.80
600 x 833mm	1467	5007	900W	A or C	81.0016	276.00	331.20
600 x 1148mm	2038	6954	900W	A or C	81.0017	382.00	458.40
1800 x 293mm	1563	5333	N/A	N/A	81.0010	185.00	222.00
1800 x 383mm	2084	7111	N/A	N/A	81.0011	231.00	277.20
1800 x 473mm	2605	8889	N/A	N/A	81.0012	289.00	346.80

* 600W Type E Element can be fitted.

Rivassa Three Column Radiators - Matt Anthracite

Size H x W	Watts	BTU	Element Output	Element Type	Code	£ Ex VAT	£ Inc VAT
300 x 1148mm	1118	3816	600W	A, C or E*	81.0029	307.00	368.40
300 x 1373mm	1342	4579	900W	A, C or E*	81.0030	368.00	441.60
600 x 428mm	734	2504	300W	C	81.0050	139.00	166.80
600 x 473mm	816	2782	300W	A or C	81.0051	154.00	184.80
600 x 518mm	898	3061	300W	A or C	81.0052	170.00	204.00
600 x 563mm	979	3339	300W	A or C	81.0053	184.00	220.80
600 x 608mm	1060	3616	600W	A or C	81.0031	203.00	243.60
600 x 833mm	1467	5007	900W	A or C	81.0032	281.00	337.20
600 x 1148mm	2038	6954	900W	A or C	81.0033	389.00	466.80
1800 x 293mm	1563	5333	N/A	N/A	81.0026	189.00	226.80
1800 x 383mm	2084	7111	N/A	N/A	81.0027	236.00	283.20
1800 x 473mm	2605	8889	N/A	N/A	81.0028	294.00	352.80

* 600W Type E Element can be fitted.

TECHNICAL INFORMATION

All measurements in Height by Width. Heat output based on $\Delta T60^{\circ}\text{C}$. Radiators that are electric only are restricted to the heat output of the elements. Element size can be increased to full capacity of rail if using element type C or E. For element types see pages 628-629. For matching valves see pages 630-634. For indirect heating systems. Tappings are the width of the rail and 80mm off the wall. Prices include radiator and wall fixings sets, valves extra.

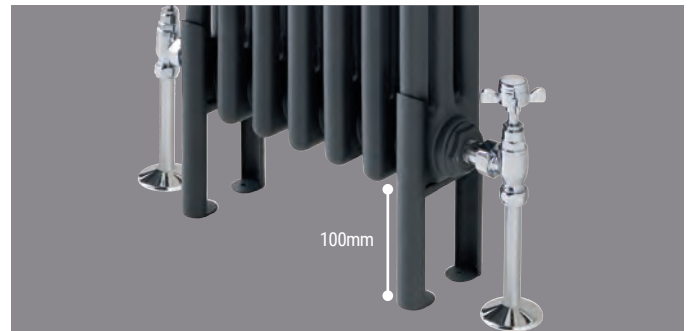

Rivassa Radiator Feet

Description	Code	£ Ex VAT	£ Inc VAT
Rivassa 3 Column Radiator Feet (pair) White	81.0036	20.00	24.00
Rivassa 3 Column Radiator Feet (pair) White	81.0037	20.00	24.00



Pictured 81.0042 White

Towel Hangers

Page 636



Robe Hooks

Page 636



Round Vent Caps

Page 637



Traditonal Range



LEADON

For element types see pages 628-629.

Our traditional range of radiators offer character and flair to ensure they fit in with your classic designs. These rails should only be used on closed or indirect heating circuits, not on fresh water hot systems as they are of steel construction.

Leadon - Chrome / White							
Size H x W x D	Watts	BTU	Element Output	Element Type	Code	£ Ex VAT	£ Inc VAT
940 x 700 x 260mm	897	3061	300W	A, C or E	41.1007	389.00	466.80

Tappings are approx. 130mm less than the width of the rail and approx. 137mm off the wall.

FEATURES

- Manufactured and tested to EN442 standard.
- 5 Year Manufacturer's Warranty.
- Can be single or dual fuel, or all electric.
- CE and NF Certificates
- * With conditions

TECHNICAL INFORMATION

All measurements in Height by Width. Heat output based on $\Delta T60^{\circ}\text{C}$. Radiators that are electric only are restricted to the heat output of the elements. Element size can be increased to full capacity of rail if using element type C or E. For element types see pages 628-629. For matching valves see pages 630-634. For indirect heating systems. Prices include radiator and wall fixings sets, valves extra.

Warranty

5

Year

Heating

All Electric

Dual-Fuel

Pair of Radiator Valves & Tails		
Code	£ Ex VAT	£ Inc VAT
41.3009	45.00	54.00

Radiator valves sold separately



THAMES

For element types see pages 628-629.

Our traditional range of radiators offer character and flair to ensure they fit in with your classic designs. These rails only be used on closed or indirect heating circuits, not on fresh water hot systems as they are of steel construction.

Thames - Chrome / White							
Size H x W x D	Watts	BTU	Element Output	Element Type	Code	£ Ex VAT	£ Inc VAT
1444 x 630 x 187mm	945	3224	300W	A, C or E	41.1004	435.00	522.00

Tappings are approx. 130mm less than the width of the rail and approx. 150mm off the wall.

FEATURES

- Manufactured and tested to EN442 standard.
- 5 Year Manufacturer's Warranty.
- Can be single or dual fuel, or all electric.
- CE and NF Certificates
- * With conditions

TECHNICAL INFORMATION

All measurements in Height by Width. Heat output based on $\Delta T60^{\circ}\text{C}$. Radiators that are electric only are restricted to the heat output of the elements. Element size can be increased to full capacity of rail if using element type C or E. For element types see pages 628-629. For matching valves see pages 630-634. For indirect heating systems. Prices include radiator and wall fixings sets, valves extra.

Warranty

5

Year

Heating

All Electric

Dual-Fuel

Pair of Radiator Valves & Tails		
Code	£ Ex VAT	£ Inc VAT
41.3009	45.00	54.00

Radiator valves sold separately

Traditonal Range



For element types see pages 628-629.

Our traditional range of radiators offer character and flair to ensure they fit in with your classic designs. These rails should only be used on closed or indirect heating circuits, not on fresh water hot systems as they are of steel construction.

Coln - Chrome / White							
Size H x W x D	Watts	BTU	Element Output	Element Type	Code	£ Ex VAT	£ Inc VAT
510 x 680 x 260mm	704	2402	300W	A or E	41.1002	293.00	351.60

On dual fuel installation, please use only Type A element.
Tappings approx. 4mm less than the width of the rail and approx. 50mm off the wall.

- FEATURES**
- Manufactured and tested to EN442 standard.
 - 5 Year Manufacturer's Warranty.
 - Can be single or dual fuel, or all electric.
 - CE and NF Certificates
 - * With conditions

TECHNICAL INFORMATION

All measurements in Height by Width. Heat output based on ▲T60°C. Radiators that are electric only are restricted to the heat output of the elements. Element size can be increased to full capacity of rail if using element type E. For element types see pages 628-629. For matching valves see pages 630-634. For indirect heating systems. Prices include radiator and wall fixings sets, valves extra.

Warranty

5

Year

Heating

All Electric

Dual-Fuel



Pair of Radiator Valves & Tails		
Code	£ Ex VAT	£ Inc VAT
41.3009	45.00	54.00

Radiator valves sold separately



Our traditional range of radiators offer character and flair to ensure they fit in with your classic designs. These rails should only be used on closed or indirect heating circuits, not on fresh water hot systems as they are of steel construction.

Twyver - Chrome / White							
Size H x W x D	Watts	BTU	Element Output	Element Type	Code	£ Ex VAT	£ Inc VAT
952 x 684 x 158mm	580	1979	N/A	N/A	41.1011	401.00	481.20

Tappings are approx. 137mm less than the width of the rail and approx. 108mm off the wall.

- FEATURES**
- Manufactured and tested to EN442 standard.
 - 5 Year Manufacturer's Warranty.
 - Not suitable for elements.
 - CE and NF Certificates.
 - * With conditions

TECHNICAL INFORMATION

All measurements in Height by Width. Heat output based on ▲T60°C. For matching valves see pages 630-634. For indirect heating systems. Prices include radiator and wall fixings sets, valves extra.

Warranty

5

Year

Heating

Elements

Build up your 'All Electric' Towel Rail/Radiator

Step 1

Choose your towel rail/radiator (Please make sure that you can see the "All Electric / Dual Fuel" icon on the chosen towel rail/radiator page).

Step 2

Refer to the "Element Output" column for the required output to suit the chosen towel rail/radiator.

Step 3

Choose which element type best suits your need from the "Element Type" column. Please check that the IP Rating is suitable for the site circumstances.

Step 4

For "All Electric" installation please add Fluid Filling.

Build up your 'Dual Fuel' Towel Rail/Radiator

Repeat **Steps 1-3** as left. Please add your radiator valves and dual fuel elbow where applicable.

Fluid filling is not required.

ELEMENT TYPE A

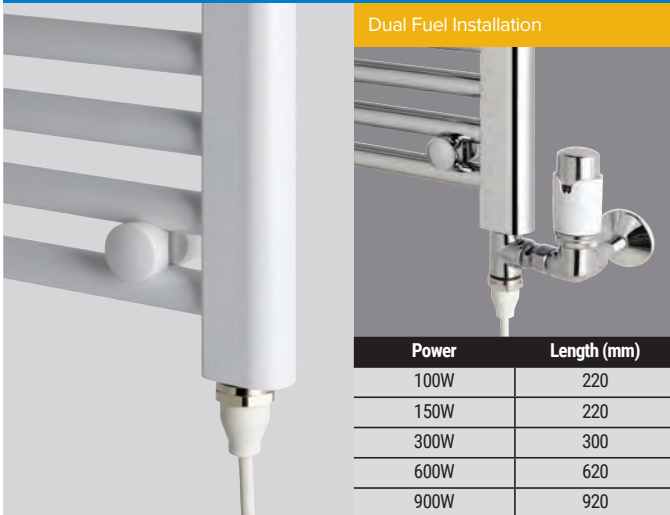

Dual Fuel Installation

Power	Length (mm)
100W	220
150W	220
300W	300
600W	620
900W	920

This element is a low cost solution for installations requiring background heat and towel drying only. Element should be rated at less than 60% of the radiator's output.

Element Type A

Description	Code	£ Ex VAT	£ Inc VAT
100 watt element	8.009	45.00	54.00
150 watt element	8.004	45.00	54.00
300 watt element	8.001	48.00	57.60
600 watt element	8.002	68.00	81.60
900 watt element	8.003	85.00	102.00
Fluid filling for above rail (electric only)*	FF	82.00	98.40

*(Not including appropriate element). I.P. rating 55. (Zone 2 and 3)

Please note all fluid filled rails are special order and are **non-returnable**.

FEATURES

- Elements use PTC self regulating technology providing excellent reliability and extended working life

TECHNICAL INFORMATION For an all electric towel rail/radiator, fluid filling must be purchased. Electric only elements will be fitted RH side unless otherwise specified.

ELEMENT TYPE C

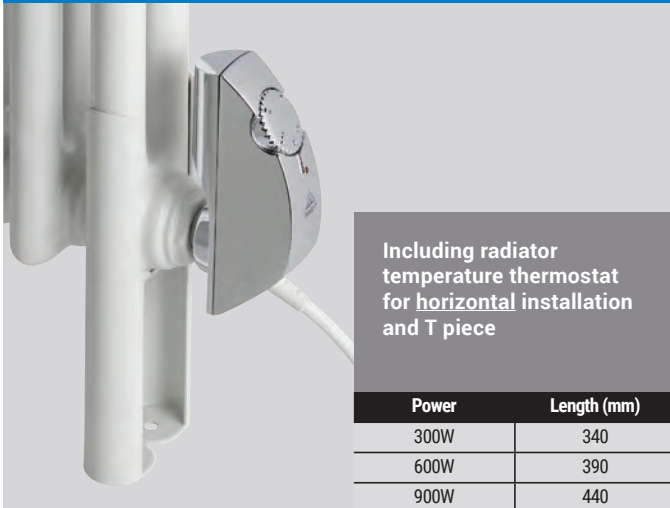

Including radiator temperature thermostat for horizontal installation and T piece

Power	Length (mm)
300W	340
600W	390
900W	440

This element is for background and full room heat. It is controlled by the water temperature and can be rated up to the output of the radiator. This is for horizontal installations only.

Element Type C

Description	Code	£ Ex VAT	£ Inc VAT
Up to 300W element (inc rad stat) horizontal	8.300	131.00	157.20
300W to 600W element (inc rad stat) horizontal	8.301	138.00	165.60
600W to 900W element (inc rad stat) horizontal	8.302	142.00	170.40
Fluid filling for above rail (electric only)*	FF	82.00	98.40
Extension piece for type c element**	8.903	12.00	14.40

*(not including appropriate element). I.P. rating 54. (Zone 2 and 3).

Please note all fluid filled rails are special order and are **non-returnable**.

**Some traditional rails may require an extension piece for a type C element.

FEATURES

- Off season heating
- Towel drying
- Low running costs
- Simple installation
- Wide temperature range 10-60°C

TECHNICAL INFORMATION For an all electric towel rail/radiator, fluid filling must be purchased. Electric only elements will be fitted RH side unless otherwise specified.

ELEMENT TYPE D

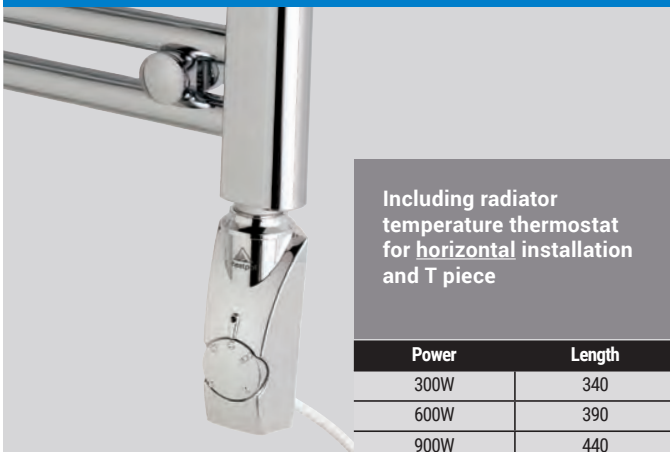

Including radiator temperature thermostat for horizontal installation and T piece

Power	Length
300W	340
600W	390
900W	440

This element is for background and full room heat and is controlled by the water temperature. It can be rated up to the output of the radiator. This is for vertical installations only.

Element Type D

Description	Code	£ Ex VAT	£ Inc VAT
Up to 300W element (inc rad stat) vertical	8.310	109.00	130.80
Up to 300W element (inc rad stat) vertical	8.311	116.00	139.20
Up to 300W element (inc rad stat) vertical	8.312	119.00	142.80
Fluid filling for above rail (electric only)*	FF	82.00	98.40

*(not including appropriate element). I.P. rating 54. (Zone 2 and 3)

Please note all fluid filled rails are special order and are **non-returnable**.

FEATURES

- Off season heating
- Towel drying
- Low running costs
- Simple installation
- Wide temperature range 10-60°C

TECHNICAL INFORMATION For an all electric towel rail/radiator, fluid filling must be purchased. Electric only elements will be fitted RH side unless otherwise specified. All elements supplied with T-piece.

Elements

Element Type E is for background and full room heat. It is controlled by the water temperature and can be rated up to the output of the radiator. This is for both vertical and horizontal installations.

ELEMENT TYPE E



Including radiator temperature thermostat for horizontal installation and T piece

Power	Length (mm)
150W	370
300W	390
600W	750

Element Type E			
Description	Code	£ Ex VAT	£ Inc VAT
150w Type E Element Chrome	8.010	96.00	115.20
300w Type E Element Chrome	8.011	99.00	118.80
600w Type E Element Chrome	8.012	112.00	134.40
150w Type E Element White	8.013	90.00	108.00
300w Type E Element White	8.014	93.00	111.60
600w Type E Element White	8.015	98.00	117.60
Fluid filling for above rail (electric only)*	FF	82.00	98.40

*(Not including appropriate element). I.P. rating 55. (Zone 1, 2 and 3)
Please note all fluid filled rails are special order and are **non-returnable**.

FEATURES

- Off season heating
- Towel drying
- Low running costs
- Simple installation
- Wide temperature range 10-60°C
- For vertical and horizontal installation

TECHNICAL INFORMATION

For an all electric towel rail/radiator, fluid filling must be purchased. Electric only elements will be fitted RH side unless otherwise specified.

ELEMENT TYPE F

White Element Chrome Element Anthracite Element



Power	Length (mm)
300W	350
600W	380

Digital temp control element including remote control and T piece



Remote Control

This element is for background and full room heat. It is controlled by the water temperature and can be rated up to the output of the radiator. This is for both vertical and horizontal installations.

Element Type E			
Description	Code	£ Ex VAT	£ Inc VAT
300w Element Type F white	8.313	221.00	265.20
600w Element Type F white	8.314	224.00	268.80
300w Element Type F chrome	8.315	233.00	279.60
600w Element Type F chrome	8.316	236.00	283.20
300w Element Type F anthracite	8.317	229.00	274.80
600w Element Type F anthracite	8.318	233.00	279.60
Spare Remote Controller for Type F Element	8.319	45.00	54.00
Fluid filling for above rail (electric only)*	FF	82.00	98.40

*(Not including appropriate element). I.P. rating 55. (Zone 1, 2 and 3)
Please note all fluid filled rails are special order and are **non-returnable**.

FEATURES

- With remote control
- Off season heating
- Towel drying
- Low running costs
- Simple installation
- Wide temperature range 10-60°C
- For vertical and horizontal installation

TECHNICAL INFORMATION

For an all electric towel rail/radiator, fluid filling must be purchased. Electric only elements will be fitted RH side unless otherwise specified. Type F elements supplied with T-piece.

CRAFTON TEMPERATURE CONTROL PANEL

Additional Chrome Cover



Crafton Temperature Control Panel			
Description	Code	£ Ex VAT	£ Inc VAT
Crafton Temperature Control Plate White	67.0004	74.00	88.80
Crafton Temperature Control Plate White	67.0005	24.00	28.80

FEATURES

- Can be fitted in the bathroom (Zone 2 rated)
- IPX5 rated
- Active LED display
- 2 hour boost function
- Low running costs
- Wattage range 100-1000 watts
- 20-100% output control
- Can be used on dual fuel and electric only installations
- Can only be fitted with Type A Element and Biava Dry Element towel rail
- Will fit all standard electrical back boxes

All Eastbrook fluid filled rails are filled with Fernox HP-5.

With over 40 years experience and continual investment in research and development, Fernox water treatment products are manufactured to the highest quality, reliability and performance. Fernox HP-5 is a pre-blended heat transfer fluid which gives a frost protection down to -5°C. It also provides long-term protection from damage caused by corrosion, limescale and bacteria and maintains a stable pH across a range of operational temperatures.

FEATURES - FERNOX

- Better heat transfer
- Anti-cavitation (lower noise)
- Anti-corrosion properties
- Anti-freeze



Manual Valves

Straight Valves



Square straight radiator valves chrome (pair)

Code	£ Ex VAT	£ Inc VAT
41.3002	41.00	49.20



Minimalist radiator valves straight chrome (pair)

Code	£ Ex VAT	£ Inc VAT
41.3005	25.00	30.00



Square straight radiator valves chrome (pair)

Code	£ Ex VAT	£ Inc VAT
12.038	56.00	67.20



Straight square radiator valves nickel (pair)

Code	£ Ex VAT	£ Inc VAT
12.039	38.00	45.60



Straight radiator valves chrome (pair)

Code	£ Ex VAT	£ Inc VAT
41.3008	26.00	31.20



Straight radiator valves matt white (pair)

Code	£ Ex VAT	£ Inc VAT
41.3013	26.00	31.20



Straight radiator valves matt anthracite (pair)

Code	£ Ex VAT	£ Inc VAT
41.3016	25.00	30.00



Straight radiator valves matt black (pair)

Code	£ Ex VAT	£ Inc VAT
41.3014	26.00	31.20

Angled Valves



Square angled radiator valves chrome (pair)

Code	£ Ex VAT	£ Inc VAT
41.3001	39.00	46.80



Minimalist radiator valves angled chrome (pair)

Code	£ Ex VAT	£ Inc VAT
41.3004	24.00	28.80



Angled square radiator valves chrome (pair)

Code	£ Ex VAT	£ Inc VAT
12.036	62.00	74.40

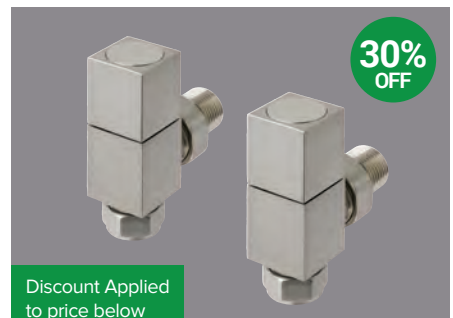

Angled square radiator valves nickel (pair)

Code	£ Ex VAT	£ Inc VAT
12.037	37.00	44.40

Manual Valves

Angled Valves (continued)



Angled radiator valves chrome (pair)

Code	£ Ex VAT	£ Inc VAT
41.3007	27.00	32.40



Angled radiator valves matt anthracite (pair)

Code	£ Ex VAT	£ Inc VAT
41.3015	26.00	31.20



Traditional rad valves & tails chrome (pair)

Code	£ Ex VAT	£ Inc VAT
41.3009	45.00	54.00



Angled radiator valves matt white (pair)

Code	£ Ex VAT	£ Inc VAT
41.3011	25.00	30.00



Angled radiator valves matt black (pair)

Code	£ Ex VAT	£ Inc VAT
41.3012	25.00	30.00

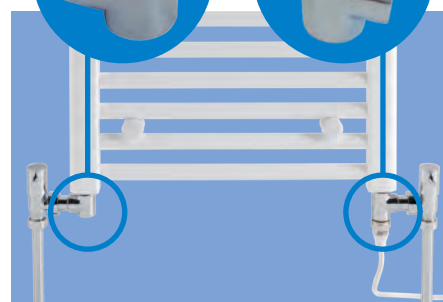

Dual fuel elbow valve and element T

Description	Code	£ Ex VAT	£ Inc VAT
Dual fuel elbow valve chrome	41.3003	7.00	8.40
Element T Piece chrome	8.901	12.00	14.40

Corner Valves



Square corner rad valves chrome (pair)

Code	£ Ex VAT	£ Inc VAT
41.3010	52.00	62.40



Corner radiator valves chrome (pair)

Code	£ Ex VAT	£ Inc VAT
41.3006	28.00	33.60



Corner radiator valves matt white (pair)

Code	£ Ex VAT	£ Inc VAT
41.3017	29.00	34.80



Corner radiator valves matt black (pair)

Code	£ Ex VAT	£ Inc VAT
41.3019	29.00	34.80



Corner radiator valves matt anthracite (pair)

Code	£ Ex VAT	£ Inc VAT
41.3018	29.00	34.80

Thermostatic Valves

Straight Thermostatic Valves



Straight Thermostatic Valves				
Description	Colour	Code	£ Ex VAT	£ Inc VAT
Wingrave Straight TRV and Lockshield	Chrome/White	12.050	12.00	14.40
Biava 15mm Straight TRV & Lockshield Valve	Chrome	12.043	31.00	37.20
Biava 15mm Straight TRV & lockshield valve	Nickel	12.033	26.00	31.20
Biava 15mm Straight TRV and Lockshield Valve	Chrome/White	12.048	24.00	28.80
15mm Straight TRV and Lockshield Valve	Matt White**	41.3020	28.00	33.60
15mm Straight TRV and Lockshield Valve	Matt Grey**	41.3026	33.00	39.60
15mm Straight TRV and Lockshield Valve	Matt Cappuccino**	41.3028	33.00	39.60
15mm Straight TRV and Lockshield Valve	Matt Anthracite**	41.3021	28.00	33.60
15mm Straight TRV and Lockshield Valve	Matt Black**	41.3022	28.00	33.60

FEATURES

- 15mm straight models
 - Approved to EN215
 - Produced to ISO 9001: - 2008
 - Energy saving - lower fuel bills
 - Controls individual radiators to allow varying comfort levels throughout the home
 - Reversible tail piece facilitates vertical or horizontal installation
 - Luxury gloss white, matt white, matt grey, matt cappuccino, matt black, brushed nickel and and chrome finishes
 - 2 Year warranty*
- * With conditions

TECHNICAL INFORMATION

**Due to different materials used, there can be a slight difference between the parts colours.

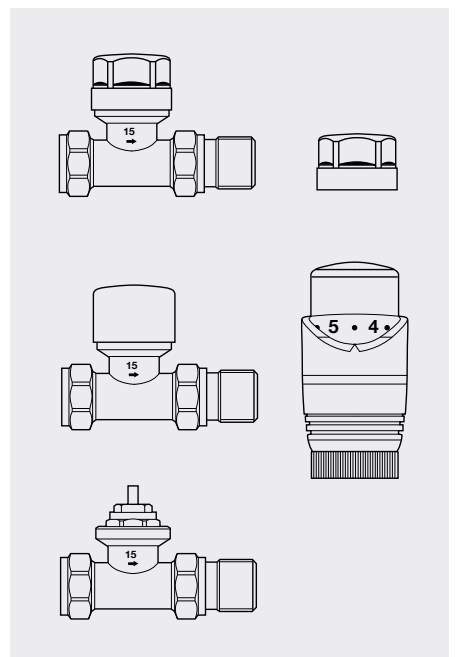

All straight TRV's are BI-DIRECTIONAL

Thermostatic Valves

Angled Thermostatic Valves

12.051

30%
OFFDiscount Applied
to price below

12.041



12.031

30%
OFFDiscount Applied
to price below

12.047



41.3023



41.3027*



41.3029*



41.3024



41.3025



Straight Thermostatic Valves

Description	Colour	Code	£ Ex VAT	£ Inc VAT
Wingrave Angled TRV and Lockshield	Chrome/White	12.051	12.00	14.40
Biava 15mm Angle TRV & Lockshield Valve	Chrome	12.041	31.00	37.20
Biava 15mm Angle TRV & lockshield valve	Nickel	12.031	26.00	31.20
Biava 15mm Angle TRV and Lockshield Valve	Chrome/White	12.047	24.00	28.80
15mm Angled TRV and Lockshield Valve	Matt White**	41.3023	27.00	32.40
15mm Angled TRV and Lockshield Valve	Matt Grey**	41.3027	32.00	38.40
15mm Angled TRV and Lockshield Valve	Matt Cappuccino**	41.3029	32.00	38.40
15mm Angled TRV and Lockshield Valve	Matt Anthracite**	41.3024	27.00	32.40
15mm Angled TRV and Lockshield Valve	Matt Black**	41.3025	27.00	32.40

FEATURES

- 15mm angled models
- Approved to EN215
- Produced to ISO 9001: - 2008
- Energy saving - lower fuel bills
- Controls individual radiators to allow varying comfort levels throughout the home
- Reversible tail piece facilitates vertical or horizontal installation
- Luxury gloss white, matt white, matt grey, matt cappuccino, matt black, brushed nickel and and chrome finishes
- 2 Year warranty*
- * With conditions

TECHNICAL INFORMATION

**Due to different materials used, there can be a slight difference between the parts colours.

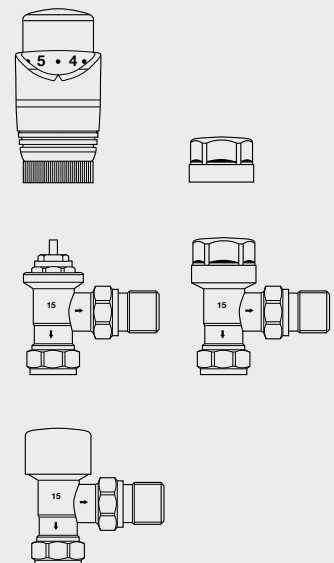

All angled TRV's are
BI-DIRECTIONAL

Thermostatic Valves

Corner Thermostatic Valves



12.045



12.035



12.049



12.053



12.054



12.055



12.056



12.057

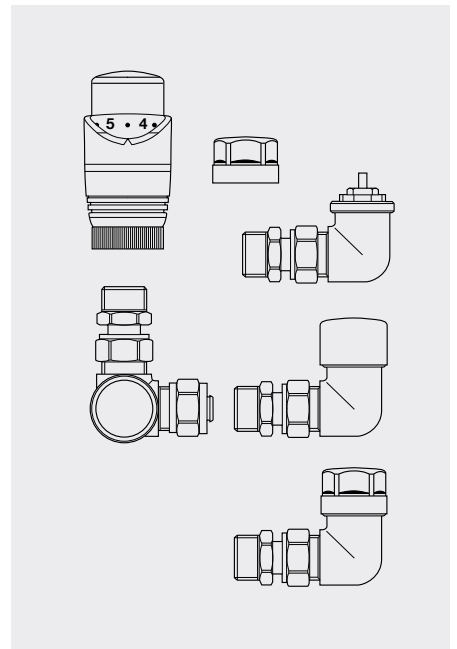

Biava Corner TRV & Lockshield Valves				
Description	Colour	Code	£ Ex VAT	£ Inc VAT
15mm Corner TRV and Lockshield Valve	Chrome	12.045	31.00	37.20
15mm Corner TRV and Lockshield Valve	Nickel/White	12.035	26.00	31.20
15mm Corner TRV and Lockshield Valve	Chrome/White	12.049	24.00	28.80
15mm Corner TRV and Lockshield Valve	Matt White**	12.053	43.00	51.60
15mm Corner TRV and Lockshield Valve	Matt Grey**	12.054	43.00	51.60
15mm Corner TRV and Lockshield Valve	Matt Cappuccino**	12.055	48.00	57.60
15mm Corner TRV and Lockshield Valve	Matt Anthracite**	12.056	43.00	51.60
15mm Corner TRV and Lockshield Valve	Matt Black**	12.057	43.00	51.60

FEATURES

- 15mm corner models
- Approved to EN215
- Produced to ISO 9001: - 2008
- Energy saving - lower fuel bills
- Controls individual radiators to allow varying comfort levels throughout the home
- Reversible tail piece facilitates vertical or horizontal installation
- Luxury gloss white, brushed nickel and chrome finishes
- 2 Year warranty*
- * With conditions

For corner TRV's flow side right hand only.

TECHNICAL INFORMATION

**Due to different materials used, there can be a slight difference between the parts colours.

Drain Off Valve				
Description	Colour	Code	£ Ex VAT	£ Inc VAT
15mm Lockshield with Drain Valve	Chrome	12.052	6.00	7.20

FEATURES

- Can be used to drain off radiators.
- Chrome plated brass body, comes with white cover cap.

TECHNICAL INFORMATION FOR ALL TRV's

Maximum Operating Temperature	110°C
Valve Body: Maximum Working Pressure	16 Bar
KV Value	Max Δp 0.6Bar
Sensor Type	Liquid Filled
Maximum Flow Temperature	120°C
Usage Range	+3°C to +27°C



12.056

Pipe Shrouds and Collar Kits



Pipe Shrouds and Collar Kits

Description	Code	£ Ex VAT	£ Inc VAT
15mm Pipe Shroud & Collar Kit White	92.0001	6.00	7.20
15mm Pipe Shroud & Collar Kit Chrome	92.0002	12.00	14.40
15mm Pipe Shroud & Collar Kit Anthracite	92.0003	7.00	8.40
15mm Pipe Shroud & Collar Kit Black	92.0004	7.00	8.40

FEATURES

- Manufactured from high grade polypropylene
- Suitable for 15mm pipes
- Available in white, anthracite, black and chrome
- Each kit includes two pipe shrouds and two collars
- Shroud length 200mm
- Easy push-fit installation



Multi-Rail Towel Hangers



Multi-Rail Hanger - Gloss White				
Size	Code	£ Ex VAT	£ Inc VAT	
300mm	101.0010	26.00	31.20	
400mm	101.0012	27.00	32.40	
450mm	101.0016	29.00	34.80	
500mm	101.0018	31.00	37.20	
600mm	101.0022	33.00	39.60	
750mm	101.0026	35.00	42.00	

Multi-Rail Hanger - Chrome				
Size	Code	£ Ex VAT	£ Inc VAT	
300mm	101.0011	34.00	40.80	
400mm	101.0015	35.00	42.00	
450mm	101.0017	39.00	46.80	
500mm	101.0021	44.00	52.80	
600mm	101.0025	47.00	56.40	
750mm	101.0027	50.00	60.00	

Multi-Rail Hanger - Matt White				
Size	Code	£ Ex VAT	£ Inc VAT	
400mm	101.0013	27.00	32.40	
500mm	101.0019	31.00	37.20	
600mm	101.0023	33.00	39.60	

Multi-Rail Hanger - Matt Anthracite				
Size	Code	£ Ex VAT	£ Inc VAT	
400mm	101.0014	27.00	32.40	
500mm	101.0020	31.00	37.20	
600mm	101.0024	33.00	39.60	

Compatible Radiators

Wendover Straights	All Models	Wingrave Straights	All Models	Biava Dry Elements	All Models	Westwards	All Models
Biava Tube on Tube	All Models	Biava Multi-Rail	All Models	Biava High Output	-		

Towel Rail Toilet Paper Holder



Toilet Paper Holder - White		
Code	£ Ex VAT	£ Inc VAT
16.155	65.00	78.00

Toilet Paper Holder - Chrome		
Code	£ Ex VAT	£ Inc VAT
16.156	70.00	84.00

Compatible Radiators

Wendover	All Models	Wingrave	All Models	Biava Dry Elements	All Models	Westwards	All Models
Biava Tube on Tube	All Models	Biava Multi-Rail	All Models				

Accessories

Vertical Tunstall Towel Hangers



Towel Hanger - Matt White				
Size	Code	£ Ex VAT	£ Inc VAT	
280mm	101.0028	33.00	39.60	
420mm	101.0032	41.00	49.20	
630mm	101.0036	48.00	57.60	



Towel Hanger - Matt Anthracite				
Size	Code	£ Ex VAT	£ Inc VAT	
280mm	101.0029	33.00	39.60	
420mm	101.0033	41.00	49.20	
630mm	101.0037	48.00	57.60	



Towel Hanger - Matt Black				
Size	Code	£ Ex VAT	£ Inc VAT	
280mm	101.0030	33.00	39.60	
420mm	101.0034	41.00	49.20	
630mm	101.0038	48.00	57.60	



Towel Hanger - Chrome				
Size	Code	£ Ex VAT	£ Inc VAT	
280mm	101.0031	36.00	43.20	
420mm	101.0035	45.00	54.00	
630mm	101.0039	52.00	62.40	

The Vertical Tunstall Towel Hangers can be fitted on both sides of the radiator. Remember, the hangers must be fitted before installing on the wall. **Must be fitted before installation!**

Horizontal Tunstall Towel Hangers



Towel Hanger - Matt White				
Size	Code	£ Ex VAT	£ Inc VAT	
330mm	101.0040	39.00	46.80	
589mm	101.0044	48.00	57.60	



Towel Hanger - Matt Anthracite				
Size	Code	£ Ex VAT	£ Inc VAT	
330mm	101.0041	39.00	46.80	
589mm	101.0045	48.00	57.60	



Towel Hanger - Matt Black				
Size	Code	£ Ex VAT	£ Inc VAT	
330mm	101.0042	39.00	46.80	
589mm	101.0046	48.00	57.60	



Towel Hanger - Chrome				
Size	Code	£ Ex VAT	£ Inc VAT	
330mm	101.0043	39.00	46.80	
589mm	101.0047	52.00	62.40	

The Horizontal Tunstall Towel Hangers can be fitted on both sides of the radiator. Remember, the hangers must be fitted before installing on the wall. **Must be fitted before installation!**

Rivassa - Towel Hangers

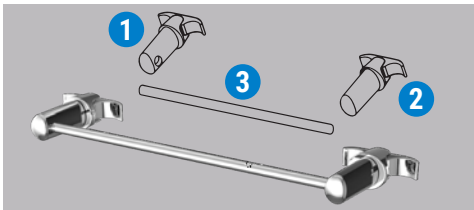

Towel hanger comes in three unassembled pieces. Please cut 600mm bar to required column-to-column length.

Rivassa Towel Hanger				
Size	Colour	Code	£ Ex VAT	£ Inc VAT
600mm	Chrome	16.158	84.00	100.80
600mm	White	16.157	58.00	69.60

Can be fitted after installation!

Rivassa - Robe Hooks



Robe Hook- Chrome				
Details	Code	£ Ex VAT	£ Inc VAT	
Single Hook	16.006	12.00	14.40	

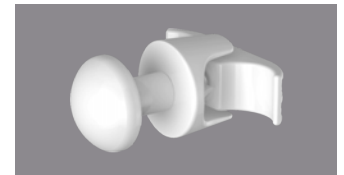

Robe Hook- White				
Details	Code	£ Ex VAT	£ Inc VAT	
Single Hook	16.005	9.00	10.80	

Can be fitted after installation!

Towel Rail - Towel Hangers

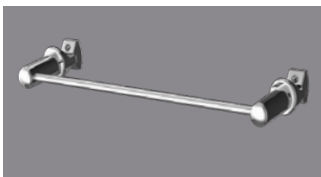

Towel Hanger - Chrome				
Size	Code	£ Ex VAT	£ Inc VAT	
210mm	16.002	45.00	54.00	
310mm	16.004	46.00	55.20	
360mm	16.352	47.00	56.40	
470mm	16.350	48.00	57.60	
600mm	16.351	50.00	60.00	

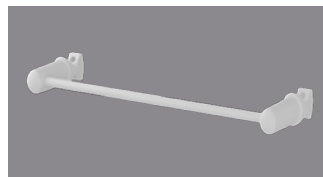

Towel Hanger - White				
Size	Code	£ Ex VAT	£ Inc VAT	
210mm	16.001	33.00	39.60	
310mm	16.003	34.00	40.80	
360mm	16.152	37.00	44.40	
470mm	16.150	40.00	48.00	
600mm	16.151	42.00	50.40	

Can be fitted after installation!

Towel Rail - Robe Hooks

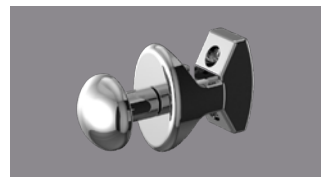

Robe Hook- Chrome				
Details	Code	£ Ex VAT	£ Inc VAT	
Hook Pair	16.500	30.00	36.00	



Robe Hook- White				
Details	Code	£ Ex VAT	£ Inc VAT	
Hook Pair	16.600	24.00	28.80	

Can be fitted after installation!

Round Vent Caps



Round Vent Caps - White			
Description	Code	£ Ex VAT	£ Inc VAT
Round Vent Cap (pair)	101.0001	7.00	8.40



Round Vent Caps - Grey			
Description	Code	£ Ex VAT	£ Inc VAT
Round Vent Cap (pair)	101.0002	7.00	8.40



Round Vent Caps - Cappuccino			
Description	Code	£ Ex VAT	£ Inc VAT
Round Vent Cap (pair)	101.0003	7.00	8.40



Round Vent Caps - Anthracite			
Description	Code	£ Ex VAT	£ Inc VAT
Round Vent Cap (pair)	101.0004	7.00	8.40



Round Vent Caps - Black			
Description	Code	£ Ex VAT	£ Inc VAT
Round Vent Cap (pair)	101.0005	7.00	8.40



Round Vent Caps - Chrome			
Description	Code	£ Ex VAT	£ Inc VAT
Round Vent Cap (pair)	101.0006	7.00	8.40

Compatible Radiators

Wendover	All Models	Biava Round	Staverton Tube on Tube Straight	Rowsham	All Models
Tuscan		Biava Tube on Tube	Staverton ToT Curved		
Wingrave	All Models	Biava Double Tube on Tube	Mezzo Tondo		
Biava Multirails	All Models	Biava Square	Pesaro		
Biava High Output		Staverton	Leonardo		
Malmesbury		Kelmscott	Rubano		
Fairford		Witney	Addington	All Models	
Burford		Rivassa	All Models Hurley		

D-Shape Vent Caps



D-Shape Vent Caps - White			
Description	Code	£ Ex VAT	£ Inc VAT
D-Shape Vent Cap (pair)	101.0007	9.00	10.80



D-Shape Vent Caps - Anthracite			
Description	Code	£ Ex VAT	£ Inc VAT
D-Shape Vent Cap (pair)	101.0008	9.00	10.80



D-Shape Vent Caps - Chrome			
Description	Code	£ Ex VAT	£ Inc VAT
D-Shape Vent Cap (pair)	101.0009	9.00	10.80

Compatible Radiators

Wingrave	All Models
----------	-------------------

Towel Rail Room Divider Bracket Sets

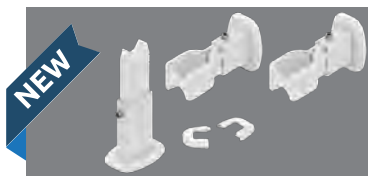

Room Divider Bracket Set - White		
Code	£ Ex VAT	£ Inc VAT
16.153	112.00	134.40



Room Divider Bracket Set - Chrome		
Code	£ Ex VAT	£ Inc VAT
16.154	158.00	189.60



Wall Bracket x2



Floor Stand Bracket x1

Compatible Radiators

Wendover	All Models	Wingrave	All Models	Biava Dry Element	All Models
Westward	All Models	Biava Multi-Rail	All Models		

Bespoke Colours



Create your unique colour radiator

Create your unique radiator!

Our selection of 20 traditional, modern bespoke RAL colours and polished aluminium allow you to inject your personal character into your radiator and help achieve that matching or statement piece look you were looking for.

What's the lead time and service details?

To calculate your bespoke price for the below 20 bespoke colours and polished aluminium finish, please add £160 ex VAT onto the desired radiator ex VAT price. For every additional radiator on the same purchase order regardless the model, size and colour you choose, please add just £80 ex VAT per additional bespoke colour radiator.

For example: A Peretti vertical radiator 1800 x 375mm 86.0057 Matt White costs £250 ex VAT. To purchase this as a bespoke colour add £160 thus making the overall price £410 plus VAT.

For a bespoke colour also in a bespoke size, please contact our sales team for the bespoke size price and the rest is simply the same as above.

For the below 20 bespoke colours, the lead time from signed confirmation is an approximate of 9 weeks.

For polished aluminium finish, the lead time from signed confirmation is an approximate of 10 weeks.

We'll happily let you know if it's completed sooner.

Which radiators can I choose from?

Please look for the Bespoke Colour icon on the brochure pages or choose from the chart (see right).

Polished aluminium finish is only available for Rosano Vertical & Horizontal, Peretti Vertical & Horizontal and Berlini Vertical radiators.

Please note:

For radiators with cover caps at the top and bottom, the cover caps will be in chrome when ordering in a bespoke colour. Bespoke coloured towel hangers are not available. All bespoke radiators will be produced in a matt (textured) finish.

All bespoke colours of our Velor aluminium towel rail model come with Chrome finish wall brackets, except for Signal Black (RAL 9004) which comes with black finish wall brackets.



Polished Aluminium

*Only available on selected models.

Radiator Range	See page
Rosano Vertical*	566-567
Rosano Horizontal*	568-569
Peretti Vertical*	572-573
Peretti Horizontal*	574-575
Guardia Vertical	578-579
Guardia Horizontal	580-581
Berlini Vertical*	586-587
Vesima Vertical	582-583
Vesima Horizontal	584
Velor Towel Rail	564-565
Addington Type10 Vertical & Horizontal	552-553
Addington Type20 Vertical & Horizontal	556-557
Addington Type21 Horizontal	558
Addington Type22 Horizontal	559
Addington Type10 Towel Rail	555
Addington Type20 Towel Rail	560
Addington Type21 Towel Rail	561



Oyster White (Matt)
RAL 1013



Light Ivory (Matt)
RAL 1015



Grey Beige (Matt)
RAL 1019



Reed Green (Matt)
RAL 6013



Purple Red (Matt)
RAL 3004



Ruby Red (Matt)
RAL 3003



Heather Violet (Matt)
RAL 4003



Cobalt Blue (Matt)
RAL 5013



Pastel Blue (Matt)
RAL 5024



Anthracite Grey (Matt)
RAL 7016



Pebble Grey (Matt)
RAL 7032



Light Grey (Matt)
RAL 7035



Window Grey (Matt)
RAL 7040



Silk Grey (Matt)
RAL 7044



Pale Brown (Matt)
RAL 8025

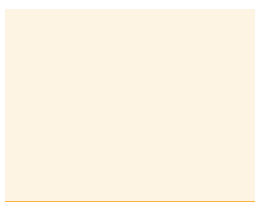

Cream (Matt)
RAL 9001



Signal Black (Matt)
RAL 9004



White Aluminium (Matt)
RAL 9006



Grey Aluminium (Matt)
RAL 9007

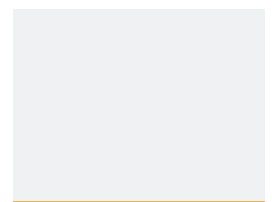

Pure White (Matt)
RAL 9010

The Radiator RAL colours above are printed within the restrictions of our brochure and should not be used for exact colour matching. All bespoke radiators will be produced in a matt (textured) finish.

Bespoke Sizes

Create your perfect sized radiator

Create your unique radiator size!

Our selection of bespoke sizes allows you to fit your radiator in tighter spaces, or even expand the size to produce a larger heat output.

What's the lead time and service details?

Request the price of your bespoke sized radiator from our sales team. They'll have the exact price and heat outputs for you in seconds!

The lead time from signed confirmation is an approximate of 9 weeks. We'll happily let you know if it's completed sooner!

Which radiators can I choose from?

You can choose any one of radiator and towel rail model that are listed in the chart (see right).

Radiator Range	See page
Rosano Vertical	566-567
Rosano Horizontal	568-569
Peretti Vertical	572-573
Peretti Horizontal	574-575
Guardia Vertical	578-579
Guardia Horizontal	580-581
Berlini Vertical	586-587
Vesima Vertical	582-583
Vesima Horizontal	584
Addington Type10 Vertical & Horizontal	552-553
Addington Type20 Vertical & Horizontal	556-557
Addington Type21 Horizontal	558
Addington Type22 Horizontal	559

What's the sizes and panel quantities to choose from?

Please choose any one of the below size specifications. Please note, to choose a height that is compatible with your selected width/panel quantity:

Addington Radiators

Width mm	Panels	400 - 900mm Heights are compatible with all widths
144	2	
218	3	
292	4	
366	5	
440	6	
514	7	
588	8	
662	9	
736	10	
810	11	
884	12	
958	13	
1032	14	
1106	15	
1180	16	
1254	17	
1328	18	
1402	19	
1476	20	
1550	21	
1624	22	
1698	23	
1772	24	
1846	25	
1920	26	
1994	27	
2068	28	
2142	29	
2216	30	
2290	31	
2364	32	
2438	33	
2512	34	
2586	35	

1000-2600mm Heights are ONLY compatible up to 884mm wide		Height mm
		1000
		1100
		1200
		1300
		1400
		1500
		1600
		1700
		1800
		1900
		2000
		2100
		2200
		2300
		2400
		2500
		2600

Rosano, Peretti & Guardia Radiators

Width mm	Panels	300 -1800mm Heights are compatible with all widths
280	3	
375	4	
470	5	
565	6	
660	7	
755	8	
850	9	
945	10	
1040	11	
1135	12	
1230	13	
1325	14	
1450	15	
1515	16	
1610	17	
1705	18	
1800	19	
1895	20	
1990	21	
2085	22	
2180	23	
2275	24	
2370	25	
2465	26	
2560	27	
2655	28	
2750	29	

Height mm	
	300
	400
	500
	600
	700
	800
	900
	1000
	1100
	1200
	1300
	1400
	1500
	1600
	1700
	1800

Vesima Radiators

Width mm	Panels	300 -1800mm Heights are compatible with all widths
303	3	
403	4	
503	5	
603	6	
703	7	
803	8	
903	9	
1003	10	
1103	11	
1203	12	
1303	13	
1403	14	
1503	15	
1603	16	
1703	17	
1803	18	
1903	19	
2003	20	
2103	21	
2203	22	
2303	23	
2403	24	
2503	25	
2603	26	
2703	27	

Height mm	
	300
	400
	500
	600
	700
	800
	900
	1000
	1100
	1200
	1300
	1400
	1500
	1600
	1700
	1800

Berlini Radiators

Width mm	Panels	Height mm
185	2	300
		400
		500
		600
		700
		800
		900
		1000
		1100
		1200
		1300
		1400
		1500
		1600
		1700
		1800

Berlini Radiators are only produced in 2 panels.



Showering

Whether you are looking for the elegance of traditional designs or the more modern up-to-date concepts, the functionality of this range adds reliability and ease of use to any bathroom.

Contents

Shower Bundles	642 - 645
Traditional and modern shower valves	646 - 659
Riser kits and Shower Poles	660 - 667
Shower handsets, hoses and brackets	667 - 670
Shower arms	642 - 673
Shower heads	674 - 675
Accessories	676 - 677



Shower Bundles

BUNDLE 1

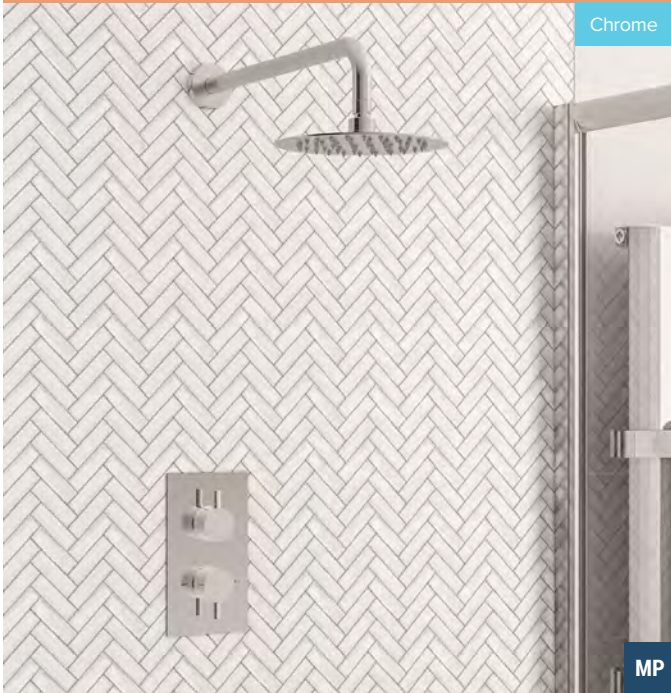

Bundle 1			
Description	Code	£ Ex VAT	£ Inc VAT
Concealed valve, round shower head & round shower arm	BND001	348.00	417.60

Bundle Components

- 68.0001 x1
- 68.0009 x1
- 68.0020 x2
- 78.0012 x1
- 78.0001 x1

BUNDLE 2

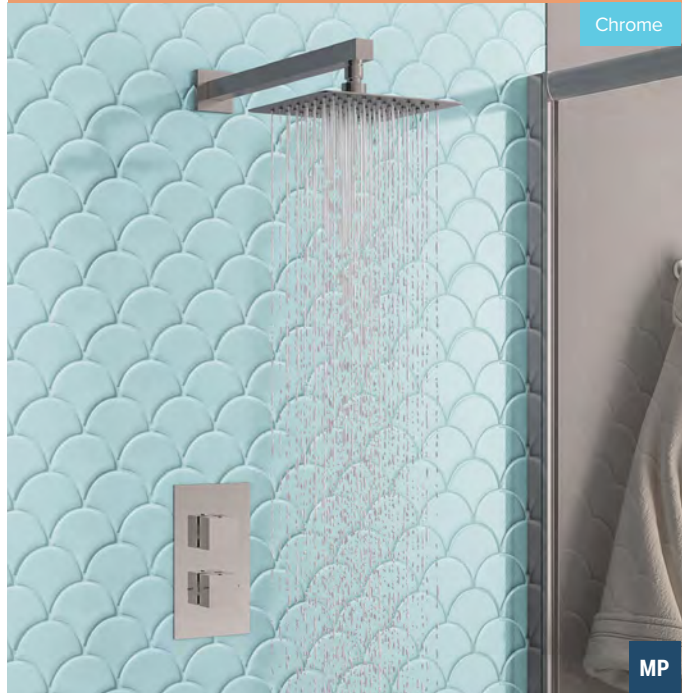

Bundle 2			
Description	Code	£ Ex VAT	£ Inc VAT
Concealed valve, square shower head & square shower arm	BND002	372.00	446.40

Bundle Components

- 68.0001 x1
- 68.0023 x1
- 68.0046 x2
- 78.0021 x1
- 78.0003 x1

BUNDLE 3



Bundle 3			
Description	Code	£ Ex VAT	£ Inc VAT
Concealed valve, round slider rail shower kit.	BND003	200.00	240.00

Bundle Components

- 93.0029 x1
- 93.0044 x1

BUNDLE 4



Bundle 4			
Description	Code	£ Ex VAT	£ Inc VAT
Concealed valve, rectangular slider rail shower kit	BND004	229.00	274.80

Bundle Components

- 93.0032 x1
- 93.0045 x1

Shower Bundles

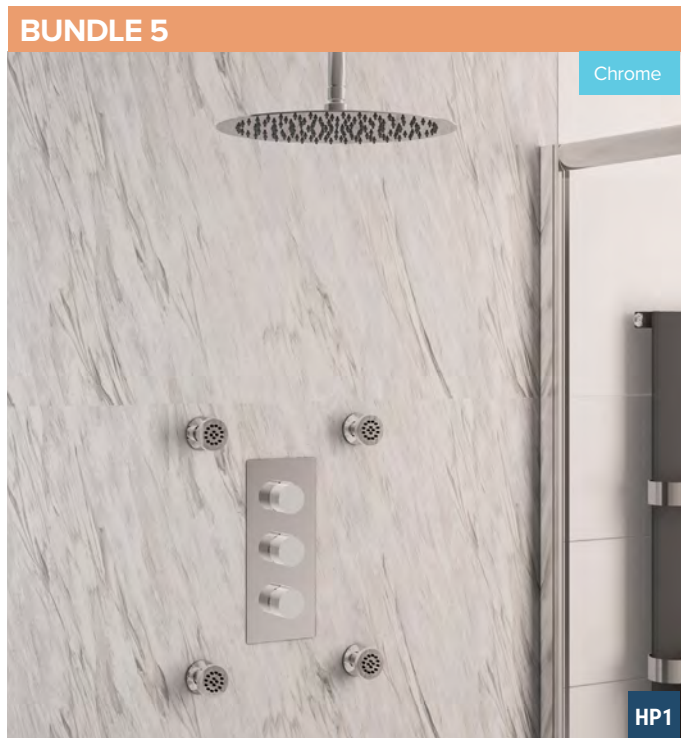

Bundle 5			
Description	Code	£ Ex VAT	£ Inc VAT
Concealed valve, round shower head, round body jets & round shower arm	BND005	573.00	687.60

- Bundle Components**
- 68.0003 x1
 - 68.0010 x1
 - 68.0011 x3
 - 78.0011 x1
 - 78.0002 x1
 - 78.0032 x4

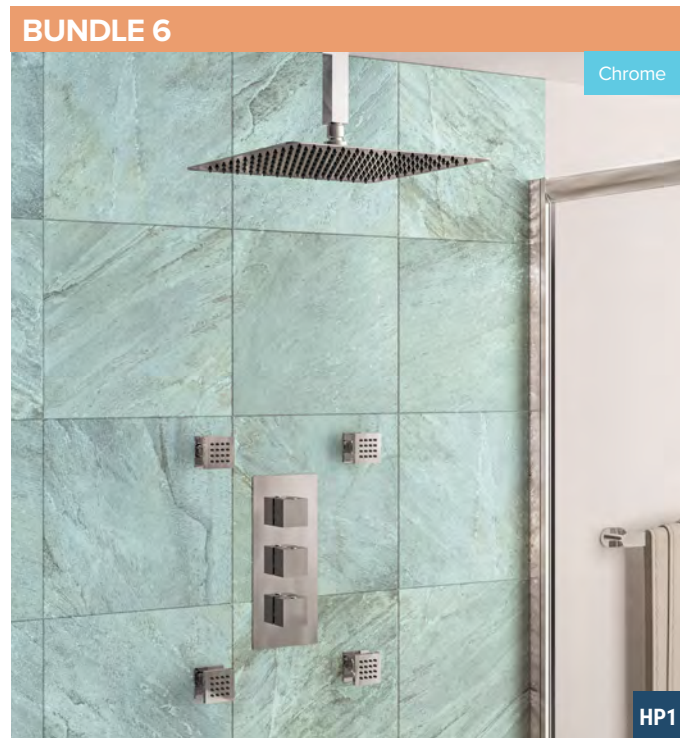

Bundle 6			
Description	Code	£ Ex VAT	£ Inc VAT
Concealed valve, rectangular shower head, square body jets & square shower arm	BND006	559.00	670.80

- Bundle Components**
- 68.0003 x1
 - 68.0024 x1
 - 68.0046 x3
 - 78.0010 x1
 - 78.0004 x1
 - 78.0031 x4

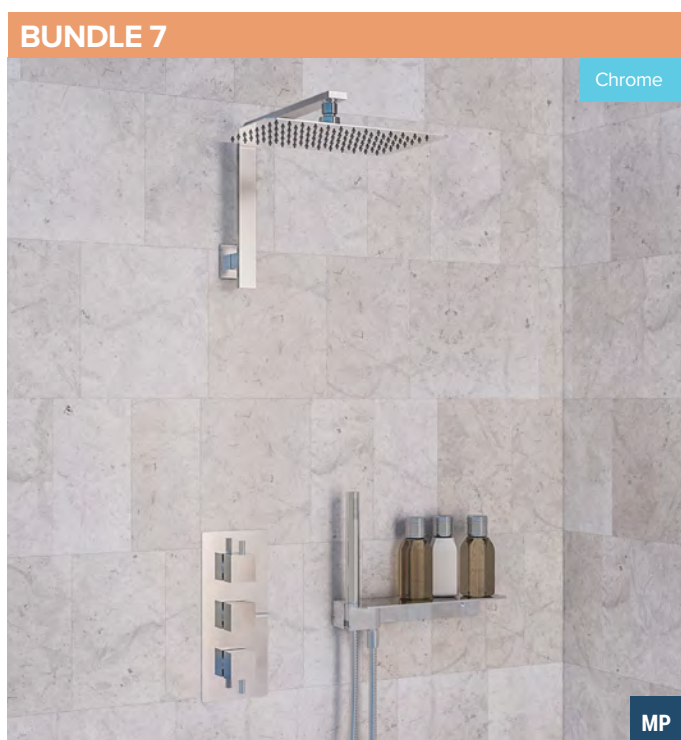

Bundle 7			
Description	Code	£ Ex VAT	£ Inc VAT
Concealed valve, rectangular shower head, square shower arm & luxury shower shelf.	BND007	617.00	740.40

- Bundle Components**
- 68.0003 x1
 - 68.0024 x1
 - 68.0012 x3
 - 78.0020 x1
 - 78.0023 x1
 - 78.0005 x1



Bundle 8			
Description	Code	£ Ex VAT	£ Inc VAT
Exposed bar valve & breeze riser shower kit	BND008	189.00	226.80

- Bundle Components**
- 97.0001 x1
 - 93.0025 x1

Complete The Look: 52.205 Shower Basket - Page 301

Shower Bundles

BUNDLE 9

Chrome / White



MP

Bundle 9

Description	Code	£ Ex VAT	£ Inc VAT
Traditional concealed valve, round shower head, swivel shower arm, shower hose, round outlet elbow & shower handset	BND009	534.00	640.80

Bundle Components		
• 68.0002 x1	• 93.0048 x1	93.0101 x1
• 68.0007 x1	• 93.0069 x1	97.0007 x1
• 68.0028 x1	• 98.0009 x1	93.0063 x1

BUNDLE 10

Smooth Black



HP1

Bundle 10

Description	Code	£ Ex VAT	£ Inc VAT
Concealed push button valve, luxury shower shelf, round shower head & round shower arm	BND010	508.00	609.60

Bundle Components	
• 93.0091 x1	• 78.0046 x1
• 78.0048 x1	• 93.0094 x1

Shower Bundles

BUNDLE 11

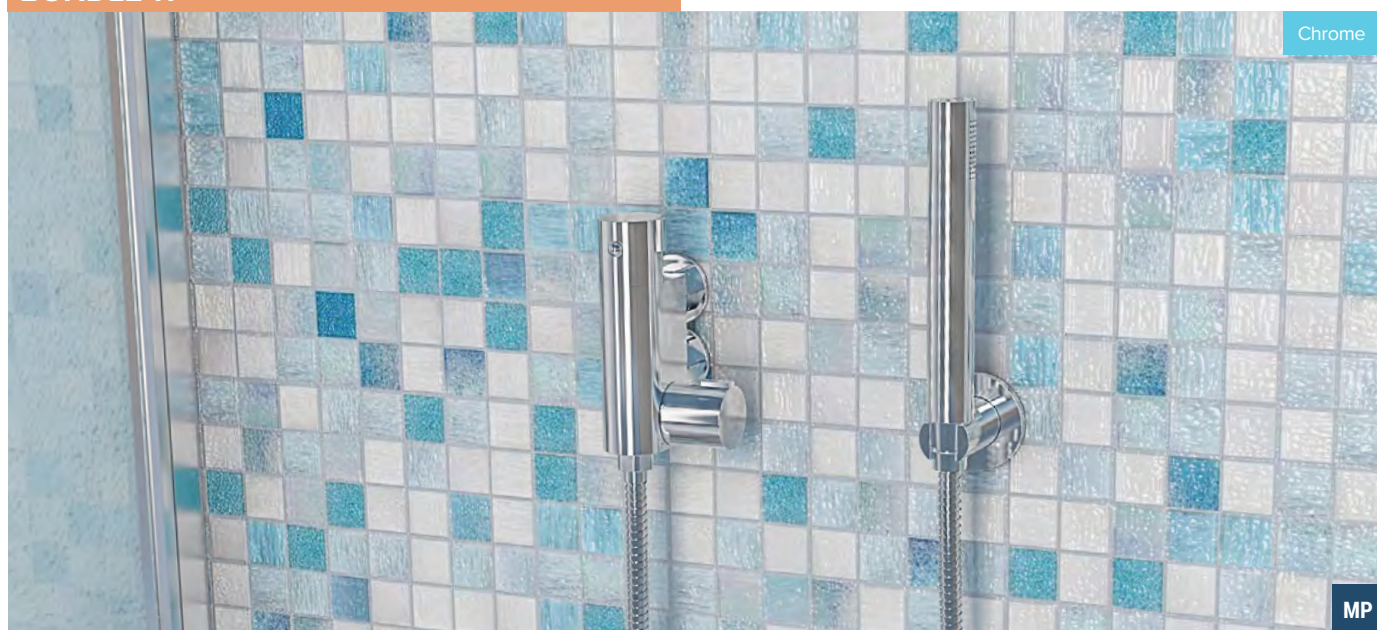

Bundle 11

Description	Code	£ Ex VAT	£ Inc VAT
Vertical exposed valve, round shower handset, shower hose & shower holder	BND010	508.00	609.60

Bundle Components

- 93.0100 x1
- 78.0040 x1
- 78.0025 x1
- 93.0064 x1

BUNDLE 12

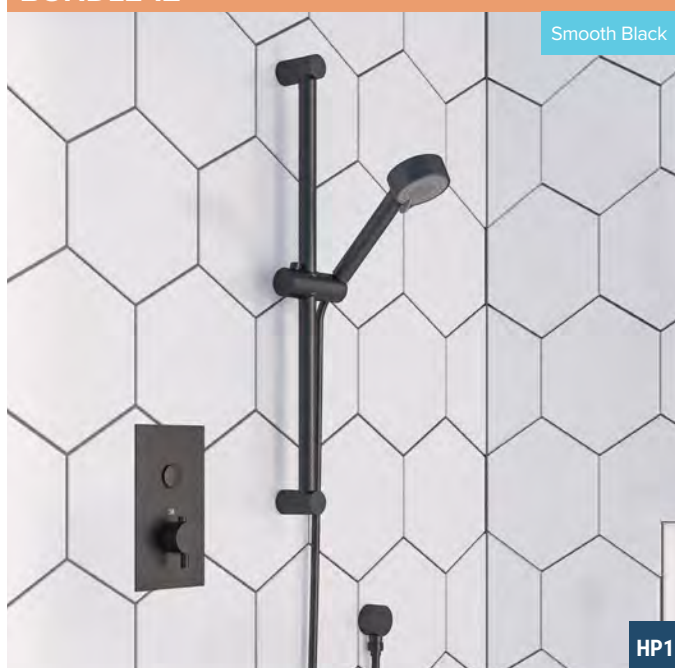

Bundle 12

Description	Code	£ Ex VAT	£ Inc VAT
Concealed push button valve, round slide rail kit & round outlet elbow	BND012	228.00	273.60

Bundle Components

- 93.0090 x1
- 93.0099 x1
- 93.0096 x1

BUNDLE 13

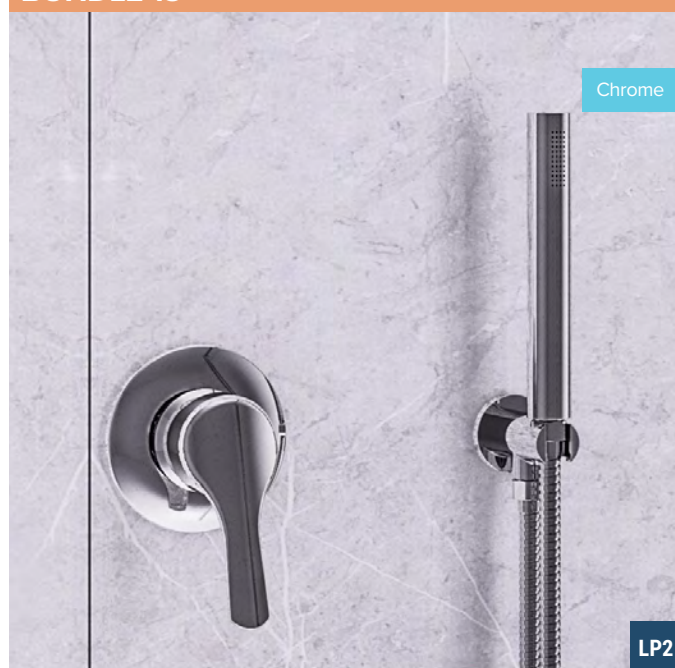

Bundle 13

Description	Code	£ Ex VAT	£ Inc VAT
Concealed manual valve, round outlet elbow with shower holder, shower hose & round round shower handset	BND013	156.00	187.20

Bundle Components

- 68.0056 x1
- 78.0040 x1
- 93.0064 x1
- 93.0106 x1

LP2 - 0.2 bar minimum

MP - 0.5 bar minimum

HP1 - 1 bar minimum

Shower Valves

TWIN CONCEALED 3/4 THERMOSTATIC SHOWER VALVES

68.0001

LP1

68.0002

LP1

68.0001, 68.0021 & 68.0046 (x2)

68.0002, 68.0023 & 68.0046 (x2)

For a complete full working shower valve you will need:

A = VALVE B = PLATE C = HANDLES

Choose the following three components to make up a complete shower valve

Valves - Chrome

Description	Code	£ Ex VAT	£ Inc VAT
Twin control shower valve only Chrome	68.0001	191.00	229.20
Twin control shower valve with diverter only	68.0002	210.00	252.00

Plates - Chrome

Description	Code	£ Ex VAT	£ Inc VAT
Oval twin plate round rings	68.0005	42.00	50.40
Square twin plate round rings	68.0009	42.00	50.40
Oval twin plate square rings	68.0021	42.00	50.40
Square twin plate square rings	68.0023	42.00	50.40

Handles - Chrome

Description	Code	£ Ex VAT	£ Inc VAT
Round control handle each	68.0011	17.00	20.40
Square lever control handle each	68.0012	18.00	21.60
Round lever control handle each	68.0020	17.00	20.40
Flow Cross Handles Each*	68.0025	18.00	21.60
Temp Cross Handles Each*	68.0026	18.00	21.60
Traditional Flow Lever Handle Each*	68.0029	16.00	19.20
Traditional Temp Lever Handle Each*	68.0030	16.00	19.20
Square Control Handle each	68.0046	17.00	20.40

*NB One flow handle and one temperature handle required for twin shower valve.

FEATURES

- Chrome plated brass body
- Excellent flow rates at all pressures
- CD cartridge technology
- Thermostatic control, anti scald & override function



On all items on this page

68.0001, 68.0023 & 68.0012 (x2)

LP1

68.0002, 68.0009, 68.0025 & 68.0026

LP1

68.0001, 68.0009 & 68.0011 (x2)

LP1

68.0002, 68.0009 & 68.0020 (x2)

LP1

68.0002, 68.0005, 68.0025 & 68.0026

LP1

68.0001, 68.0005 & 68.0011 (x2)

LP1

68.0002, 68.0005 & 68.0020 (x2)

LP1

68.0001, 68.0021 & 68.0012 (x2)

LP1

68.0002, 68.0005, 68.0029 & 68.0030

LP1

Shower Valves

TRIPLE CONCEALED 3/4 THERMOSTATIC SHOWER VALVES

68.0003, 68.0010
& 68.0011 (x3)



LP1

68.0003, 68.0010
& 68.0020 (x3)

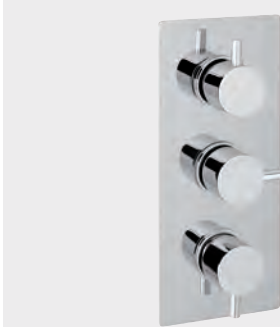

LP1

68.0003, 68.0010
68.0025 (x2) &
68.0026

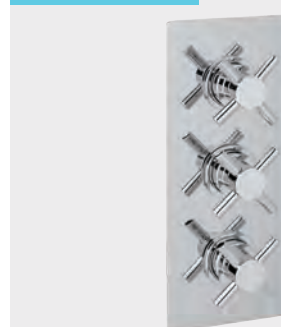

LP1

68.0004, 68.0010
68.0029 (x2) &
68.0030



LP1

68.0004, 68.0024
& 68.0012 (x3)



LP1

68.0004, 68.0024
& 68.0046 (x3)



LP1

For a complete full working shower valve you will need:

A = VALVE B = PLATE C = HANDLES

Choose the following three components to make up a complete shower valve

Valves - Chrome

Description	Code	£ Ex VAT	£ Inc VAT
Twin control shower valve only	68.0003	210.00	252.00
Twin control shower valve with diverter only	68.0004	247.00	296.40

Plates - Chrome

Description	Code	£ Ex VAT	£ Inc VAT
Square triple plate square rings	68.0024	53.00	63.60
Square triple plate round rings	68.0010	53.00	63.60

Handles - Chrome

Description	Code	£ Ex VAT	£ Inc VAT
Round control handle each	68.0011	17.00	20.40
Square lever control handle each	68.0012	18.00	21.60
Round lever control handle each	68.0020	17.00	20.40
Flow Cross Handles Each*	68.0025	18.00	21.60
Temp Cross Handles Each*	68.0026	18.00	21.60
Traditional Flow Lever Handle Each*	68.0029	16.00	19.20
Traditional Temp Lever Handle Each*	68.0030	16.00	19.20
Square Control Handle each	68.0046	17.00	20.40

*NB Two flow handles and one temperature handle required for triple shower valve.

FEATURES

- Chrome plated brass body
- Excellent flow rates at all pressures
- Ceramic Disk cartridge technology
- Thermostatic control, anti scald & override function



On all items on this page

68.0003

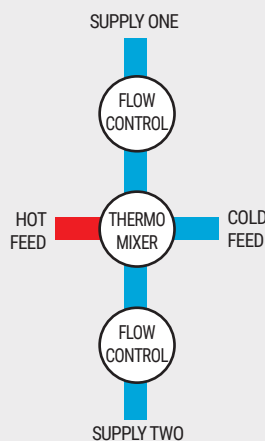

68.0004

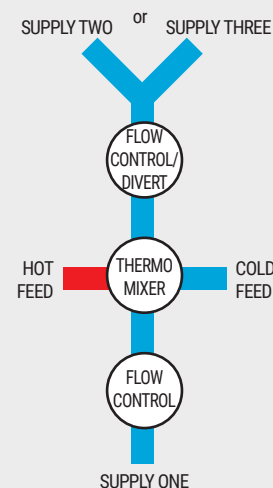

LP1 - 0.1 bar minimum

Pressure (bar)	Flow (litres/min)
0.1	9
0.5	23
1	38
2	54
3	65

Note: At maintained equal inlet pressures with open outlet at mid blend temperature.

Shower Valves

CONCEALED 3/4 TRIPLE OUTLET THERMOSTATIC SHOWER VALVES

68.0003, 68.0006
68.0029 (x2) &
68.0030



LP1

68.0003, 68.0022
& 68.0046 (x3)



LP1

68.0004, 68.0006
68.0025 (x2) &
68.0026



LP1

68.0004, 68.0006
& 68.0020 (x3)



LP1

68.0003, 68.0006
& 68.0011 (x3)

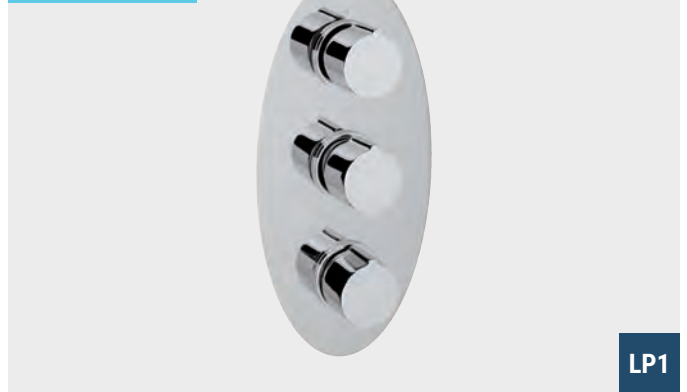

LP1

68.0003, 68.0022
& 68.0012 (x3)



LP1

For a complete full working shower valve you will need:

A = VALVE B = PLATE C = HANDLES

Choose the following three components to make up a complete shower valve

Valves - Chrome

Description	Code	£ Ex VAT	£ Inc VAT
Triple control shower valve only	68.0003	210.00	252.00
Triple control shower valve with diverter only	68.0004	247.00	296.40

Plates - Chrome

Description	Code	£ Ex VAT	£ Inc VAT
Oval triple plate round rings	68.0006	78.00	93.60
Oval triple plate square rings	68.0022	78.00	93.60

Handles - Chrome

Description	Code	£ Ex VAT	£ Inc VAT
Round control handle each	68.0011	17.00	20.40
Square lever control handle each	68.0012	18.00	21.60
Flow Cross Handles Each*	68.0025	18.00	21.60
Temp Cross Handles Each*	68.0026	18.00	21.60
Round lever control handle each	68.0020	17.00	20.40
Traditional Flow Lever Handle Each*	68.0029	16.00	19.20
Traditional Temp Lever Handle Each*	68.0030	16.00	19.20
Square Control Handle each	68.0046	17.00	20.40

*NB Two flow handles and one temperature handle required for triple shower valve.

FEATURES

- Chrome plated brass body
- Excellent flow rates at all pressures
- Ceramic Disk cartridge technology
- Thermostatic control, anti scald & override function



On all items on this page

Pressure (bar)	Flow (litres/min)
0.1	9
0.5	23
1	38
2	54
3	65

Note: At maintained equal inlet pressures with open outlet at mid blend temperature.

LP1 - 0.1 bar minimum

Shower Valves

CONCEALED TRADITIONAL THERMOSTATIC 3/4 SHOWER VALVES

68.0001, 68.0007
68.0027 &
68.0028



LP1

68.0003, 68.0008
68.0027 & (x2)
68.0028



LP1

68.0002, 68.0007
68.0028 &
68.0029



LP1

68.0004, 68.0008
68.0029 & (x2)
68.0028



LP1

68.0002, 68.0007
68.0029 &
68.0030



LP1

68.0004, 68.0008
68.0029 & (x2)
68.0030



LP1

For a complete full working shower valve you will need:

A = VALVE B = PLATE C = HANDLES

Choose the following three components to make up a complete shower valve

Valves - Chrome

Description	Code	£ Ex VAT	£ Inc VAT
Twin control shower valve only Chrome	68.0001	191.00	229.20
Twin control shower valve with diverter only	68.0002	210.00	252.00
Triple control shower valve only	68.0003	210.00	252.00
Triple control shower valve with diverter only	68.0004	247.00	296.40

Plates - Chrome

Description	Code	£ Ex VAT	£ Inc VAT
Traditional twin plate only	68.0007	46.00	55.20
Traditional triple plate only	68.0008	56.00	67.20

Handles - Chrome

Description	Code	£ Ex VAT	£ Inc VAT
Traditional Flow Cross Handle Each*	68.0027	19.00	22.80
Traditional Temp Cross Handle Each*	68.0028	19.00	22.80
Traditional Flow Lever Handle Each*	68.0029	16.00	19.20
Traditional Temp Lever Handle Each*	68.0030	16.00	19.20

*NB Two flow handles and one temperature handle required for triple shower valve.

FEATURES

- Chrome plated brass body
- Excellent flow rates at all pressures
- Ceramic Disk cartridge technology
- Thermostatic control, anti scald & override function



On all items on this page

Shower Valves

CONCEALED 3/4 PUSH BUTTON SHOWER VALVES

Modern push button flow controlled shower valves for easy operation and minimalist appearance. Available in single, twin or triple outlets for all your showering needs.



HP1

Round Concealed Thermostatic Single Push Button Shower Valve Chrome

Single Push Button Shower Valves			
Description	Code	£ Ex VAT	£ Inc VAT
Single Push Button	93.0029	151.00	181.20
Pressure	HP1 (1 bar minimum)		



HP1

Round Concealed Thermostatic Double Push Button Shower Valve Chrome

Double Push Button Shower Valves			
Description	Code	£ Ex VAT	£ Inc VAT
Double Push Button	93.0030	191.00	229.20
Pressure	HP1 (1 bar minimum)		



HP1

Round Concealed Thermostatic Triple Push Button Shower Valve Chrome

Triple Push Button Shower Valves			
Description	Code	£ Ex VAT	£ Inc VAT
Triple Push Button	93.0031	214.00	256.80
Pressure	HP1 (1 bar minimum)		



HP1

Square Concealed Thermostatic Single Push Button Shower Valve

Single Push Button Shower Valves			
Description	Code	£ Ex VAT	£ Inc VAT
Single Push Button	93.0032	153.00	183.60
Pressure	HP1 (1 bar minimum)		



HP1

Square Concealed Thermostatic Double Push Button Shower Valve

Double Push Button Shower Valves			
Description	Code	£ Ex VAT	£ Inc VAT
Double Push Button	93.0033	193.00	231.60
Pressure	HP1 (1 bar minimum)		



HP1

Square Concealed Thermostatic Triple Push Button Shower Valve

Triple Push Button Shower Valves			
Description	Code	£ Ex VAT	£ Inc VAT
Triple Push Button	93.0034	217.00	260.40
Pressure	HP1 (1 bar minimum)		

FEATURES

All push button shower valves on this page:

- Chrome plated brass body
- Thermostatic control
- Ceramic disc cartridge technology
- Anti-scald & override function
- Can operate multiple functions at the same time

Pressure (bar)	Flow (litres/min)
1	11
2	16.2
3	20

Note: At maintained equal inlet pressures with open outlet at mid blend temperature.

MP - 0.5 bar minimum

HP1 - 1 bar minimum

Shower Valves



On all items on this page

CONCEALED 3/4 PUSH BUTTON SHOWER VALVES

Modern push button flow controlled shower valves for easy operation and minimalist appearance. Available in single, twin or triple outlets for all your showering needs.



HP1

Round Concealed Thermo Single Push Button Shower Valve Matt Smooth Black

Round Single Push Button		
Code	£ Ex VAT	£ Inc VAT
93.0090*	158.00	189.60

Pressure HP1 (1 bar minimum)

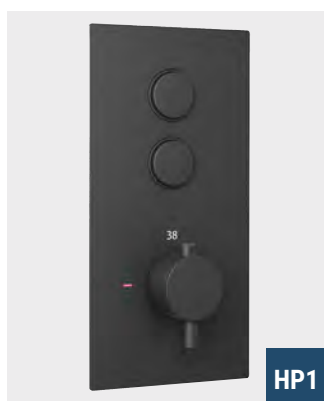

HP1

Round Concealed Thermo Double Push Button Shower Valve Matt Smooth Black

Round Double Push Button		
Code	£ Ex VAT	£ Inc VAT
93.0091*	198.00	237.60

Pressure HP1 (1 bar minimum)

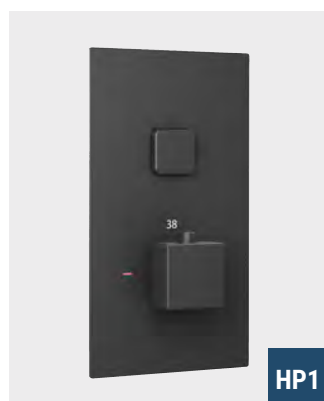

HP1

Square Concealed Thermo Single Push Button Shower Valve Matt Smooth Black

Square Single Push Button		
Code	£ Ex VAT	£ Inc VAT
93.0092*	159.00	190.80

Pressure HP1 (1 bar minimum)

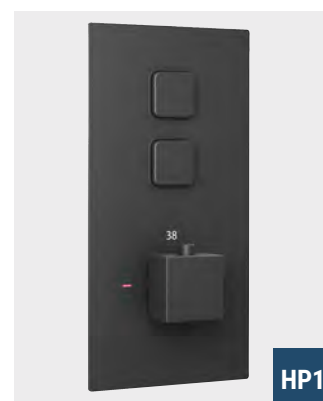

HP1

Square Concealed Thermo Double Push Button Shower Valve Matt Smooth Black

Square Double Push Button		
Code	£ Ex VAT	£ Inc VAT
93.0093*	201.00	241.20

Pressure HP1 (1 bar minimum)

FEATURES

All push button shower valves on this page:

- Matt Smooth Black finish
- Ceramic disc cartridge technology
- Can operate multiple functions at the same time
- Thermostatic control
- Anti-scald & override function

Pressure (bar)	Flow (litres/min)
1	11
2	16.2
3	20

Note: At maintained equal inlet pressures with open outlet at mid blend temperature.



THERMOSTATIC BATH SHOWER MIXERS

Thermostatic bath shower mixers that can be wall or deck mounted.



93.0038

New Biava Wall Mounted Thermostatic BSM w/o Kit Chrome

Code	£ Ex VAT	£ Inc VAT
93.0038	111.00	133.20

Pressure MP (0.5 bar minimum)

- Fixing centres 150mm
- Chrome plated brass body
- Thermostatic control
- Ceramic disc cartridge technology
- Anti-scald & override function
- Built in diverter

Shower kits page 667 - 670

93.0038 Pressure (bar)	Flow (litres/min)
0.5	8.3
1	12
2	18.5
3	22.5

Note: At maintained equal inlet pressures with open outlet at mid blend temperature.



93.0039

Cotswold Wall Mounted Thermostatic BSM w/o kit Chrome

Code	£ Ex VAT	£ Inc VAT
93.0039	94.00	112.80

Pressure MP (0.5 bar minimum)

- Fixing centres 150mm
- Chrome plated brass body
- Thermostatic control
- Ceramic disc cartridge technology
- Anti-scald & override function
- Built in diverter

Shower kits page 667 - 670

93.0039 Pressure (bar)	Flow (litres/min)
0.5	9
1	13.5
2	19.8
3	23.2

Note: At maintained equal inlet pressures with open outlet at mid blend temperature.



Pictured 93.0038 with 93.0040

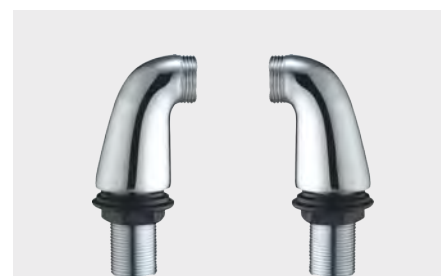

93.0040

Deck Mounting Pillars Chrome		
Code	£ Ex VAT	£ Inc VAT
93.0040	25.00	30.00

When fitted with 93.0038 or 93.0039, please change their centre fixings from 150mm to 180mm.

Shower Valves

CONCEALED HORIZONTAL THERMOSTATIC SHOWER VALVE

Horizontal thermostatic shower valve with built-in shower handset and second outlet for a bath filler or fixed shower head.

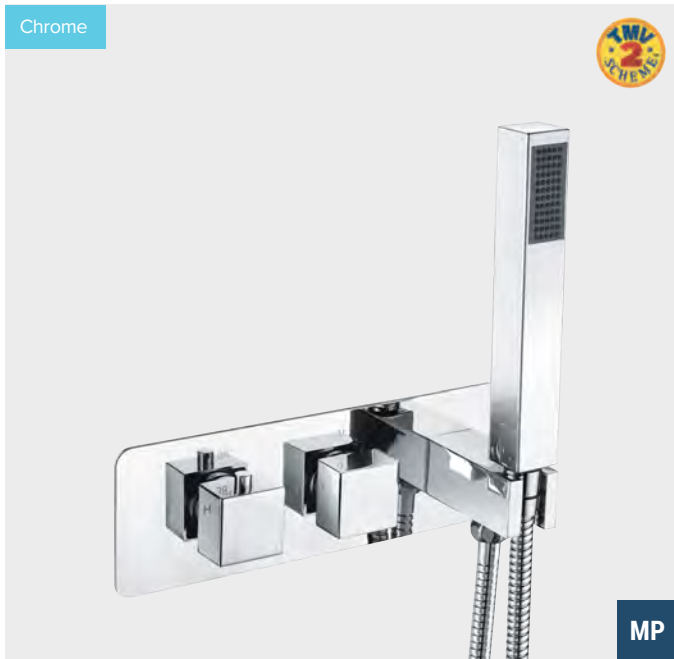

Square Horizontal Thermostatic Shower Valve Inc Kit Chrome			
Description	Code	£ Ex VAT	£ Inc VAT
Square Horizontal Thermostatic Shower Valve Inc Kit	93.0027	224.00	268.80
Pressure	MP (0.5 bar minimum)		

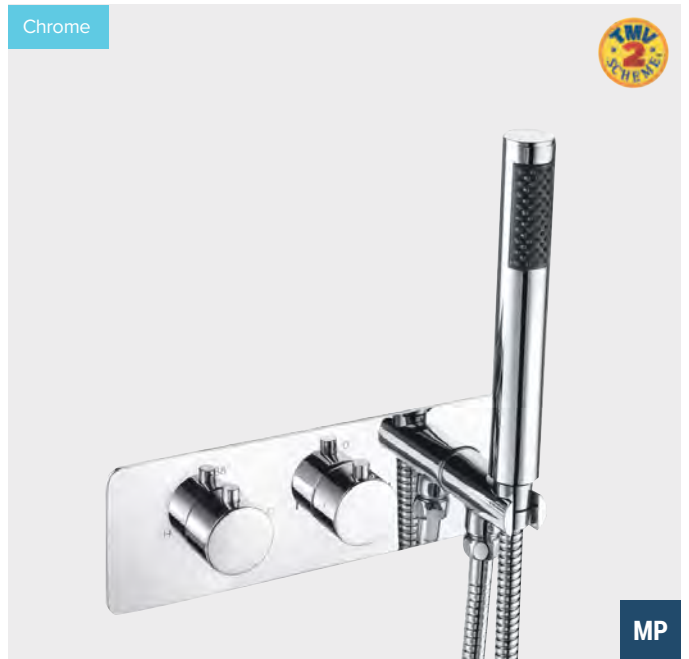

Round Horizontal Thermostatic Shower Valve Inc Kit Chrome			
Description	Code	£ Ex VAT	£ Inc VAT
Round Horizontal Thermostatic Shower Valve Inc Kit	93.0028	212.00	254.40
Pressure	MP (0.5 bar minimum)		

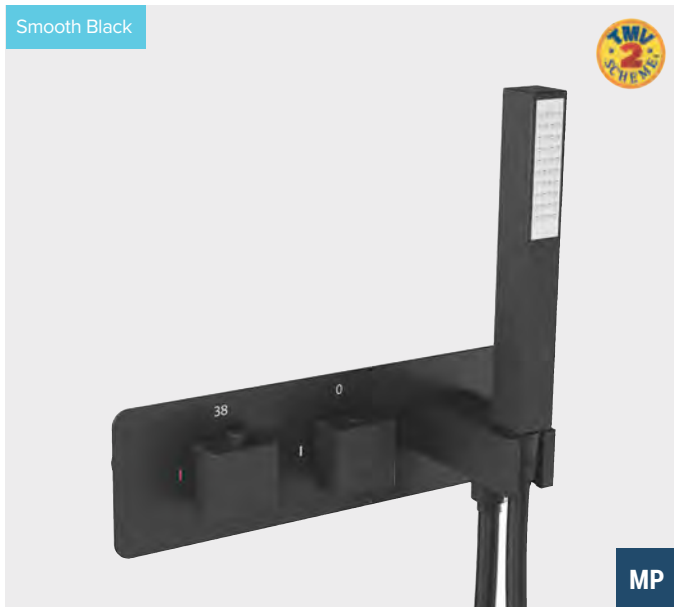

Square Horizontal Shower Valve Inc Kit			
Description	Code	£ Ex VAT	£ Inc VAT
Square Horizontal Thermostatic Shower Valve Inc Kit	93.0086	233.00	279.60
Pressure	MP (0.5 bar minimum)		

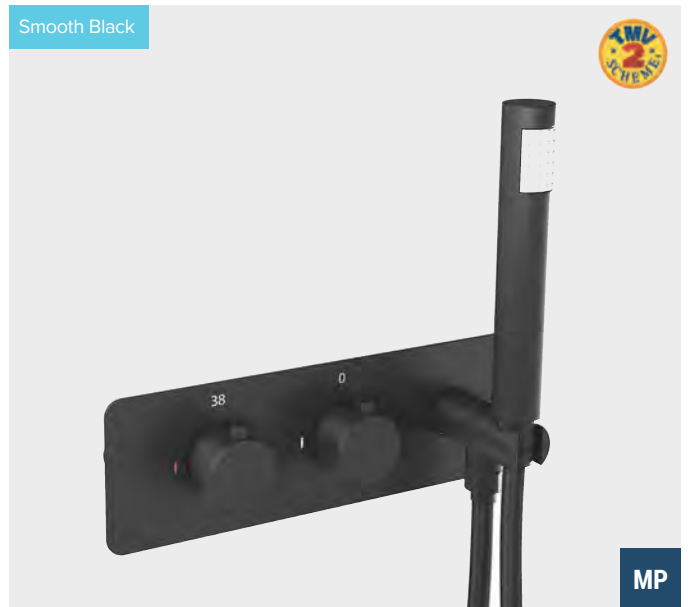

Round Horizontal Shower Valve Inc Kit			
Description	Code	£ Ex VAT	£ Inc VAT
Round Horizontal Thermostatic Shower Valve Inc Kit	93.0087	221.00	265.20
Pressure	MP (0.5 bar minimum)		

FEATURES

All shower valves on this page:

- Brass construction
- Thermostatic control
- Ceramic disc cartridge technology
- Anti-scald & override function

Single function handset and shower hose included

Pressure (bar)	Flow (litres/min)
0.5	9.7
1	14
2	20.5
3	27

Note: At maintained equal inlet pressures with open outlet at mid blend temperature.

Shower Valves

MANUAL SHOWER VALVES

Manufactured from solid brass, this traditional yet stylish manual valve is suitable for both concealed and exposed installations. With hard-wearing and reliable ceramic disc technology and an easy-to-use lever action, this valve is suitable for all installations.

Manual Valve
Concealed 68.0056



NEW

LP2

Manual Valve
Exposed 68.0056



NEW

LP2

Manual Valve Exposed / Concealed			
Description	Code	£ Ex VAT	£ Inc VAT
Manual Valve Exposed / Concealed	68.0056	91.00	109.20
Pressure	LP2 (0.2 bar minimum)		

- Chrome plated brass body
- Excellent flow rates at all pressures
- Ceramic disc cartridge technology
- Exposed valve has 150 centres



NOSTALGIC SINGLE LEVER SHOWER VALVE

Manufactured from solid brass, this traditional yet stylish manual valve is suitable for both concealed and exposed installations. With hard-wearing and reliable ceramic disc technology and an easy-to-use lever action, this valve is suitable for all installations.

Nostalgic Exposed
68.0051



LP1

Compatible
Traditional
Riser Kit
'Stratford'
Page 667

Nostalgic Single Lever Manual Shower Valve			
Description	Code	£ Ex VAT	£ Inc VAT
Nostalgic Single Lever Manual Shower Valve	68.0051	100.00	120.00
Pressure	LP1 (0.1 bar minimum)		

- Chrome plated brass body
- Excellent flow rates at all pressures
- Ceramic disc cartridge technology
- Exposed valve has 150 centres

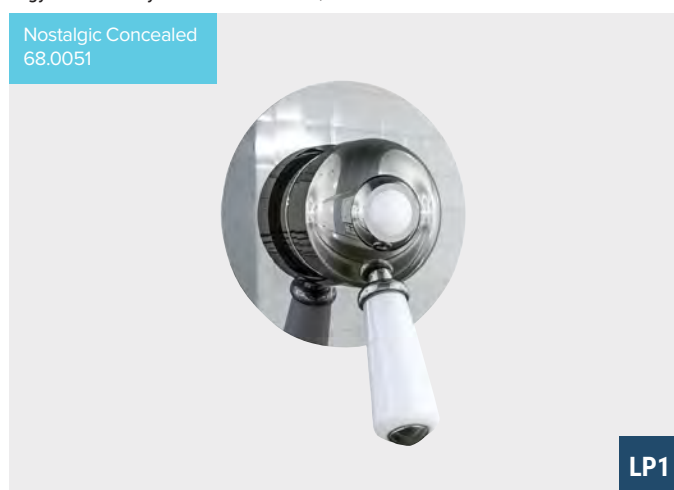

Pressure (bar)	Flow (litres/min)
0.1	7.3
0.2	9.6
0.5	13.8
1	18.2
2	22.5
3	26.5

Note: At maintained equal inlet pressures with open outlet at mid blend temperature

LP1	- 0.1 bar minimum	MP	- 0.5 bar minimum
LP2	- 0.2 bar minimum		

Shower Valves



On all items on this page

THERMOSTATIC SHOWER VALVES



68.0032

LP2

Thermostatic Lever Concealed Shower Valve

Description	Code	£ Ex VAT	£ Inc VAT
Thermostatic Lever Concealed Shower Valve	68.0032	280.00	336.00

Pressure LP2 (0.2 bar minimum)

- Chrome plated brass body
- Excellent flow rates at all pressures
- Ceramic disc cartridge technology
- Exposed valve has 150mm centres
- Thermostatic control, anti scald & override function



68.0031

LP2

Thermostatic Lever Exposed Shower Valve

Description	Code	£ Ex VAT	£ Inc VAT
Thermostatic Lever Exposed Shower Valve	68.0031	288.00	345.60

Pressure LP2 (0.2 bar minimum)

Pressure (bar)	Flow (litres/min)
0.2	9.3
0.5	12.3
1	14.4
2	17.1
3	20.6

Note: At maintained equal inlet pressures with open outlet at mid blend temperature

THERMOSTATIC CROSS HEAD VALVES



68.0034

LP2

Thermostatic Crosshead Concealed Shower Valve

Description	Code	£ Ex VAT	£ Inc VAT
Thermostatic Crosshead Concealed Shower Valve	68.0034	280.00	336.00

Pressure LP2 (0.2 bar minimum)

- Chrome plated brass body
- Excellent flow rates at all pressures
- Ceramic disc cartridge technology
- Exposed valve has 150mm centres
- Thermostatic control, anti scald & override function



68.0033

LP2

Thermostatic Crosshead Exposed Shower Valve

Description	Code	£ Ex VAT	£ Inc VAT
Thermostatic Crosshead Exposed Shower Valve	68.0033	288.00	345.60

Pressure LP2 (0.2 bar minimum)

Pressure (bar)	Flow (litres/min)
0.2	8.7
0.5	11.9
1	13.9
2	16.5
3	20.1

Note: At maintained equal inlet pressures with open outlet at mid blend temperature

LP2 - 0.2 bar minimum



On all items on this page

Shower Valves

TRADITIONAL THERMOSTATIC SHOWER VALVES

Elegance is the essence with the Traditional Valves, whether you prefer the appearance of the concealed or the exposed shower valve system. This high quality collection, with its excellence in both design and reliability, adds sophistication to any lifestyle.

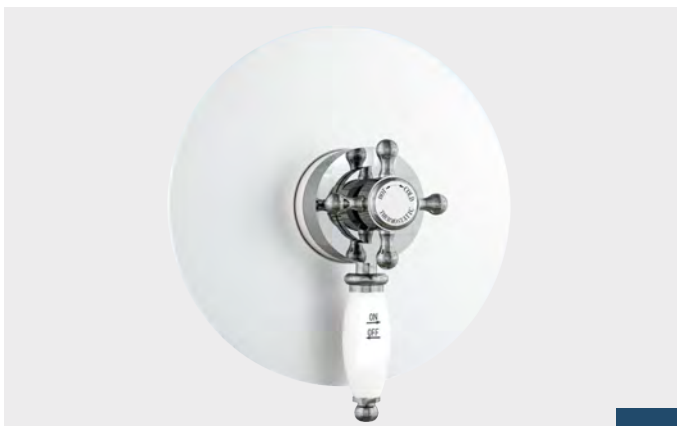

68.0050

LP2

Traditional Concealed Thermostatic Shower Valve

Description	Code	£ Ex VAT	£ Inc VAT
Traditional concealed thermostatic shower valve	68.0050	277.00	332.40

Pressure LP2 (0.2 bar minimum)

- Chrome plated brass body
- Excellent flow rates at all pressures
- Ceramic disc cartridge technology
- Exposed valve has 150mm centres
- Thermostatic control, anti scald & override function



Compatible Traditional Riser Kit 'Stratford' Page 667

68.0049

LP2

Traditional Exposed Thermostatic Shower Valve

Description	Code	£ Ex VAT	£ Inc VAT
Traditional exposed thermostatic shower valve	68.0049	263.00	315.60

Pressure LP2 (0.2 bar minimum)

Pressure (bar)	Flow (litres/min)
0.2	8.7
0.5	11.9
1	13.9
2	16.5
3	20.1

Note: At maintained equal inlet pressures with open outlet at mid blend temperature

TRADITIONAL THERMOSTATIC SHOWER VALVES

An elegant Edwardian-styled shower incorporating the latest technology. These valves are manufactured from solid brass and are suitable for use with all recognised installations including combination boilers and gravity systems. This high-performance shower comes complete with precise thermostatic control and an anti-scald device, making it extremely safe and simple to use.



68.0019

LP2

Thermostatic Traditional Concealed Shower Valve

Description	Code	£ Ex VAT	£ Inc VAT
Thermostatic traditional concealed shower valve	68.0019	343.00	411.60

Pressure LP2 (0.2 bar minimum)

- Chrome plated brass body
- Excellent flow rates at all pressures
- Ceramic disc cartridge technology
- Exposed valve has 150mm centres
- Thermostatic control, anti scald & override function



Compatible Traditional Riser Kit 'Stratford' Page 667

68.0018

LP2

Thermostatic Traditional Exposed Shower Valve

Description	Code	£ Ex VAT	£ Inc VAT
Thermostatic traditional exposed shower valve	68.0018	360.00	432.00

Pressure LP2 (0.2 bar minimum)

Pressure (bar)	Flow (litres/min)
0.2	8.7
0.5	11.9
1	13.9
2	16.5
3	20.1

Note: At maintained equal inlet pressures with open outlet at mid blend temperature

Shower Valves

TRADITIONAL EXPOSED TWIN THERMOSTATIC VALVE

Designed to coordinate with our taps and mixers, these quality, high performance valves are manufactured from solid brass. Separate flow and temperature controls mean the showers are easy to adjust and safe to use, making them ideal for a family environment. The valves are suitable for use with all recognised installations, including combination boilers and gravity systems.



Compatible Traditional Riser Kit 'Stratford' Page 667

LP1

Traditional Twin Exposed Thermostatic Shower Valve

Description	Code	£ Ex VAT	£ Inc VAT
Twin Exposed Shower Valve	68.0048	290.00	348.00

Pressure LP1 (0.1 bar minimum)

- Chrome plated brass body
- Excellent flow rates at all pressures
- Ceramic disc cartridge technology
- Exposed valve has 150mm centres
- Thermostatic control, anti scald & override function



Compatible Traditional Riser Kit 'Stratford' Page 667

LP1

Traditional Twin Exposed Thermostatic Shower Valve

Description	Code	£ Ex VAT	£ Inc VAT
Twin Exposed Shower Valve	68.0047	290.00	348.00

Pressure LP1 (0.1 bar minimum)

Pressure (bar)	Flow (litres/min)
0.1	7
0.2	8.6
0.5	11.7
1	13.5
2	16.5
3	20

Note: At maintained equal inlet pressures with open outlet at mid blend temperature

VERTICAL THERMOSTATIC SHOWER VALVE



MP1

Vertical Thermostatic Shower Valve Chrome

Description	Code	£ Ex VAT	£ Inc VAT
Vertical Thermostatic Shower Valve Chrome	93.0100	84.00	100.80

Pressure LP1 (0.1 bar minimum)

- Chrome plated brass body
- Thermostatic control
- Ceramic disc cartridge technology
- Thermostatic control, anti scald & override function



Pressure (bar)	Flow (litres/min)
0.5	8.1
1	11.4
2	16.2
3	20.5

Note: At maintained equal inlet pressures with open outlet at mid blend temperature

Shower Valves



HP1

TRADITIONAL RISER KIT WITH TWIN VALVE



HP1

Traditional Riser Kit With Twin Valve

Description	Code	£ Ex VAT	£ Inc VAT
Traditional Riser with Twin Valve	93.0071	393.00	471.60

Pressure HP1 (1 bar minimum)

FEATURES

Shower Kit

- 8" Brass chrome plated shower head.
- Polished stainless steel sliding bar.
- Single feature brass chrome plated shower handset.
- Stainless steel shower hose.

Shower Valve

- Chrome plated brass body.
- CD cartridge technology.
- Brass & Ceramic handles.
- Fixing centres 150mm
- Thermostatic control, Anti-scald & override function.
- On HP2, showerhead and handset can be operated simultaneously.

Pressure (bar)	Flow (litres/min)
1	12.5
2	18
3	22

Note: At maintained equal inlet pressures with open outlet at mid blend temperature.

LP1 - 0.1 bar minimum

HP1 - 1 bar minimum

MP - 0.5 bar minimum

Bar Valves

THERMOSTATIC BAR VALVES

Exposed bar valves in a range of styles and prices to suit all designs.



MP

Round Thermostatic Bar Valve Matt Smooth Black

Description	Code	£ Ex VAT	£ Inc VAT
Round Thermostatic Bar Valve Matt Smooth Black	93.0089	93.00	111.60

Pressure MP (0.5 bar minimum)

- Excellent flow rates at all pressures
- Ceramic disc cartridge technology
- Thermostatic control, Anti-scald & override function.

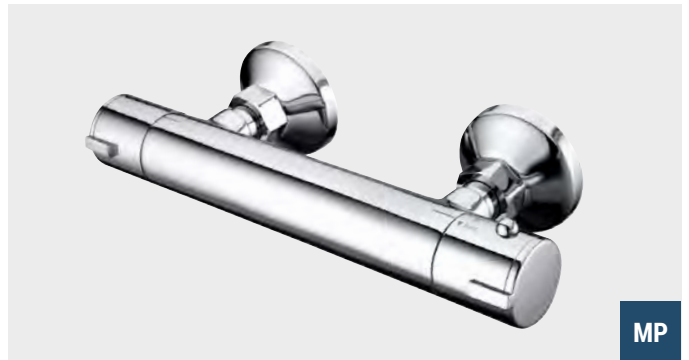

MP

Round Thermostatic Bar Valve Chrome

Description	Code	£ Ex VAT	£ Inc VAT
Round Thermostatic Bar Valve Chrome	93.0025	88.00	105.60

Pressure MP (0.5 bar minimum)

Pressure (bar)	Flow (litres/min)
0.5	8.8
1	12.6
2	18.1
3	22.2

Note: At maintained equal inlet pressures with open outlet at mid blend temperature

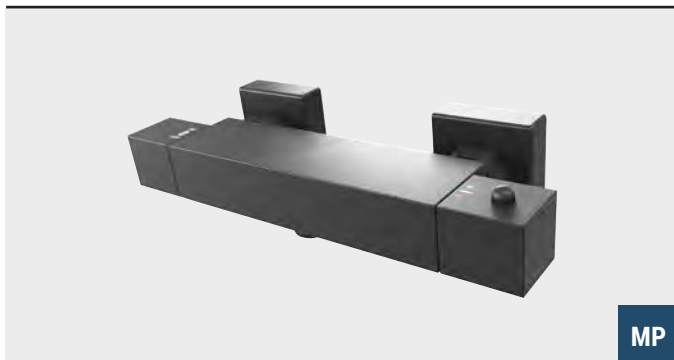

MP

Square Thermostatic Bar Valve Matt Smooth Black

Description	Code	£ Ex VAT	£ Inc VAT
Square Thermostatic Bar Valve Matt Smooth Black	93.0088	110.00	132.00

Pressure MP (0.5 bar minimum)

- Excellent flow rates at all pressures
- Ceramic disc cartridge technology
- Thermostatic control, Anti-scald & override function.



MP

Square Thermostatic Bar Valve Chrome

Description	Code	£ Ex VAT	£ Inc VAT
Square Thermostatic Bar Valve Chrome	93.0026	105.00	126.00

Pressure MP (0.5 bar minimum)

Pressure (bar)	Flow (litres/min)
0.5	8.8
1	12.6
2	18.1
3	22.2

Note: At maintained equal inlet pressures with open outlet at mid blend temperature

MP - 0.5 bar minimum

ACCESSORIES



Backplate Elbow Unions

Description	Code	£ Ex VAT	£ Inc VAT
Backplate Elbow Unions	93.0060	15.00	18.00



Concealed Fixing Bracket

Description	Code	£ Ex VAT	£ Inc VAT
Concealed fixing bracket	68.0055	25.00	30.00

Bar Valves & Shower Shelves

CONTEMPORARY BAR VALVE



LP1

Contemporary TMV2 Bar Valve Inc Kit

Description	Code	£ Ex VAT	£ Inc VAT
Contemporary TMV2 bar valve inc kit	30.6000	98.00	117.60

Pressure LP1 (0.1 bar minimum)

- Exposed valve has 150mm centres
- Thermostatic control, anti scald & override function

FEATURES

Shower Kit

- Chrome plated brass body
- Slider rail with adjustable wall fixing brackets
- Excellent flow rates at all pressures
- CD cartridge technology
- Thermostatic control, anti scald function
- Six function handset



LUXURY SHOWER SHELF



Contemporary TMV2 Bar Valve Inc Kit

Description	Code	£ Ex VAT	£ Inc VAT
Shower Shelf inc shower kit	78.0023	133.00	159.60

FEATURES

- Stainless steel construction
- Polished finish
- Built-in outlet elbow
- Includes single function brass shower handset & stainless steel shower hose
- Requires shower valve
- Concealed rear inlet

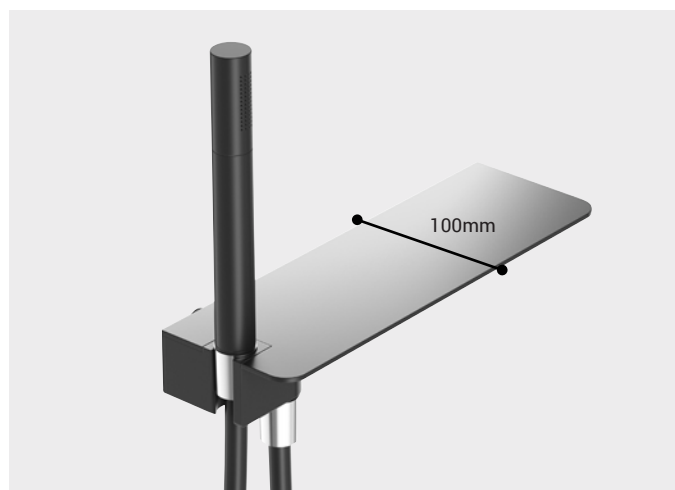
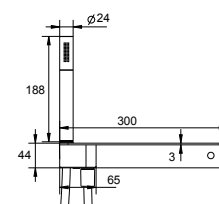

Shower Shelf Inc Shower Kit Matt Smooth Black

Description	Code	£ Ex VAT	£ Inc VAT
Shower Shelf inc shower kit matt smooth black	78.0048	220.00	264.00

FEATURES

- Stainless steel construction
- Matt smooth black finish
- Built-in outlet elbow
- Includes single function brass shower handset & PVC shower hose
- Requires shower valve
- Concealed rear inlet

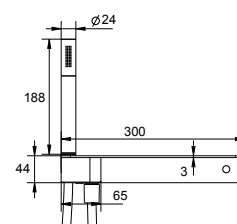

LP1 - 0.1 bar minimum

MP - 0.5 bar minimum

Shower Poles

VEROLI THERMOSTATIC SHOWER SET WITH SHELF



HP1



Veroli Thermostatic Shower Set With Shelf Chrome

Description	Code	£ Ex VAT	£ Inc VAT
Veroli Thermostatic Shower Set with shelf Chrome	78.0042	625.00	750.00

Pressure HP1 (1 bar minimum)

FEATURES

- Thermostatic control
- Push button style diverters
- Practical built-in shelf
- Single function brass hand-set included
- Height 1048mm
- Backplate width 500mm
- Backplate height 110mm

THERMOSTATIC SHOWER POLE INC BAR VALVE & KIT



HP1.5

Thermostatic Shower Pole Inc Bar Valve & Kit

Description	Code	£ Ex VAT	£ Inc VAT
Thermostatic Shower Pole inc bar valve & kit	78.0035	327.00	392.40

Pressure HP1.5 (1.5 bar minimum)

- Thermostatic control anti scald & override function

FEATURES

- Adjustable height (800-1300mm)
- Solid brass construction
- Chrome finish
- 8" Stainless steel shower head (2mm thickness)
- Single function brass shower hand set
- Temperature controlled brass thermostatic bar valve with built-in diverter

MP - 0.5 bar minimum

HP1.5 - 1.5 bar minimum

HP1 - 1 bar minimum

Shower Poles

WINTERBOURNE SHOWER POLE



Height is adjustable.

MP

Winterbourne Shower Pole

Description	Code	£ Ex VAT	£ Inc VAT
Winterbourne Shower Pole	56.2068	446.00	535.20

Pressure MP (0.5 bar minimum)

- Height (adjustable) 815-1150mm
- Fixing centres 150mm
- Chrome plated brass body
- Thermostatic control
- Ceramic disc cartridge technology
- Anti scald & override function

WINSLADE SHOWER POLE



MP

Winslade Shower Pole

Description	Code	£ Ex VAT	£ Inc VAT
Winslade Shower Pole	56.2069	327.00	392.40

Pressure MP (0.5 bar minimum)

- Height 1155mm
- Fixing centres 150mm
- Chrome plated brass body
- Thermostatic control
- Ceramic disc cartridge technology
- Anti scald & override function

THERMOSTATIC SHOWER POLE



HP1.5

Thermostatic Shower Pole with built-in shelf

Thermostatic Shower Pole

Description	Code	£ Ex VAT	£ Inc VAT
Thermostatic Shower Pole	78.0014	418.00	501.60

Pressure HP1.5 (1.5 bar minimum)

- Height Adjustable (900-1300mm)
- Stainless steel construction
- 10" stainless steel shower head
- Thermostatic valve temperature control
- Built in diverter (constructed as a shelf)
- Single function brass head set included
- Three button control: Shower head, shower hand set & bath filler outlet (outlet centre 100mm from wall)
- Thermostatic control, anti scald & override function



Thermostatic Flow Control



Push Button Diverter Control

Riser Kits

RISER KITS



MP

Slim Sliding Riser Kit

Description	Code	£ Ex VAT	£ Inc VAT
Slim Sliding Riser Kit	97.0006	49.00	58.80

Pressure MP (0.5 bar minimum)

- Height 640mm
- Stainless steel rail construction
- Includes 3 function handset, shower hose & outlet elbow



LP1

Boston Slide Rail Kit

Description	Code	£ Ex VAT	£ Inc VAT
Boston slide rail kit	56.2020	81.00	97.20

Pressure LP1 (0.1 bar minimum)

- Fixing Centres 531mm



LP1

Kubix Slider Rail Kit Chrome

Description	Code	£ Ex VAT	£ Inc VAT
Kubix Slider Rail Kit Chrome	93.0042	78.00	93.60

Pressure LP1 (0.1 bar minimum)

- Height 640mm
- Stainless steel rail construction
- Includes single function handset, shower hose & outlet elbow



LP1

Sheer Rectangular Slide Rail Chrome

Description	Code	£ Ex VAT	£ Inc VAT
Sheer Rectangular Slide Rail Chrome	93.0045	76.00	91.20

Pressure LP1 (0.1 bar minimum)

- Height 700mm
- Stainless steel rail construction
- Includes single function handset, shower hose & outlet elbow
- Chrome finish



MP

Swivel Sliding Riser Kit

Description	Code	£ Ex VAT	£ Inc VAT
Swivel Sliding Riser Kit	97.0004	48.00	57.60

Pressure MP (0.5 bar minimum)

- Height 570mm
- Includes 5 function handset & shower hose
- Chrome finish



LP1

Memphis Slide Rail Kit

Description	Code	£ Ex VAT	£ Inc VAT
Memphis slide rail kit	56.2021	75.00	90.00

Pressure LP1 (0.1 bar minimum)

- Fixing centres 265mm

Riser Kits

RISER KITS



MP

Adjustable Slide Rail Kit Matt Smooth Black

Code	£ Ex VAT	£ Inc VAT
93.0099	48.00	57.60

Pressure MP (0.5 bar minimum)

- Height 640mm
- Includes 3 function handset & PVC shower hose



MP

Adjustable Slide Rail Kit Chrome

Code	£ Ex VAT	£ Inc VAT
93.0046	41.00	49.20

Pressure MP (0.5 bar minimum)

- Height 640mm
- Stainless steel rail construction
- Includes 3 function handset & shower hose
- Chrome finish



LP1

Linear Slide Rail Kit Chrome

Code	£ Ex VAT	£ Inc VAT
93.0044	49.00	58.80

Pressure LP1 (0.1 bar minimum)

- Height 600mm
- Stainless steel rail construction
- Includes single function handset, shower hose & outlet elbow
- Chrome finish



MP

Curved Sliding Riser Kit

Code	£ Ex VAT	£ Inc VAT
97.0002	53.00	63.60

Pressure MP (0.5 bar minimum)

- Height 540mm
- Includes 5 function handset, shower hose & outlet elbow
- Chrome finish

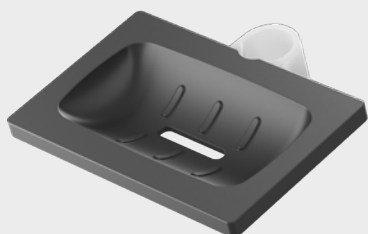

Soap Holder for Slide Rail 93.0099

Description	Code	£ Ex VAT	£ Inc VAT
Soap Holder for Slide Rail 93.0099	93.0098	8.00	9.60

Only compatible with 93.0099

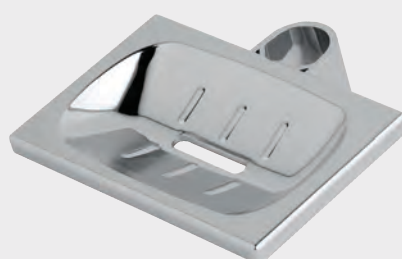

Soap Holder for Slide Rail 93.0046

Description	Code	£ Ex VAT	£ Inc VAT
Soap Holder for Slide Rail 93.0046	93.0070	7.00	8.40

Only compatible with: 93.0046

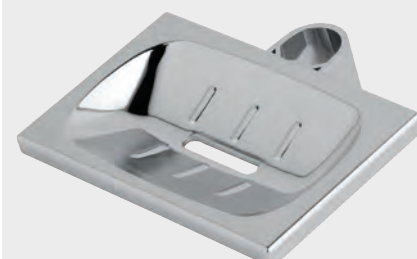

Soap Holder for Slide Rail 93.0044 Chrome

Description	Code	£ Ex VAT	£ Inc VAT
Soap Holder for Slide Rail 93.0044 Chrome	93.0047	7.00	8.40

Only compatible with: 93.0044

MP - 0.5 bar minimum

LP1 - 0.1 bar minimum

Riser Kits

RISER KITS



LP1

Needle Sliding Riser Kit

Description	Code	£ Ex VAT	£ Inc VAT
Needle Sliding Riser Kit	97.0005	37.00	44.40

Pressure LP1 (0.1 bar minimum)

- Height 610mm
- Stainless steel rail construction
- Includes single function handset & shower hose
- Chrome finish



MP

Riser Kit With Round Soap Dish

Description	Code	£ Ex VAT	£ Inc VAT
Riser Kit with Round Soap Dish	102.001	47.00	56.40

Pressure MP (0.5 bar minimum)

- Height 617mm
- Stainless steel sliding bar
- Includes three function handset and stainless steel shower hose
- Chrome finish

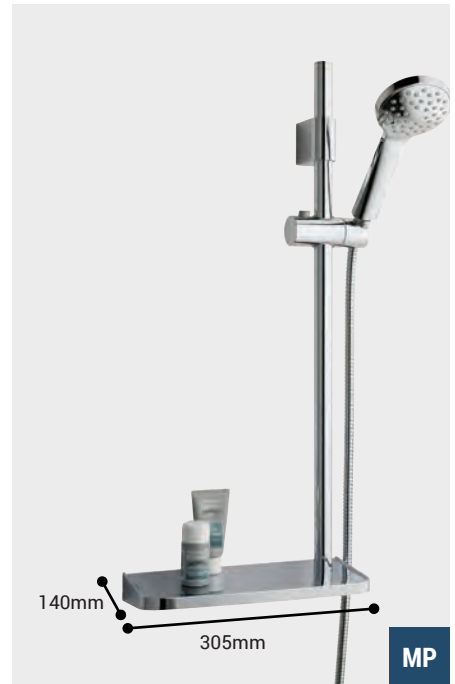

MP

Riser Kit With Rectangular Soap Dish

Description	Code	£ Ex VAT	£ Inc VAT
Riser Kit with Rectangular Soap Dish	102.002	58.00	69.60

Pressure MP (0.5 bar minimum)

- Height 700mm
- Stainless steel sliding bar
- Includes single function handset and stainless steel shower hose
- Chrome finish



LP1

The one handset can be used in two positions as either a fixed shower head or an adjustable height handset.

Dual Sliding Shower Riser Kit

Description	Code	£ Ex VAT	£ Inc VAT
Dual Sliding Shower Riser Kit	97.0003	61.00	73.20

Pressure LP1 (0.1 bar minimum)

- Height 600mm
- Includes only one 3-function handset & shower hose
- Chrome finish



HP2

8mm shower head

Diverter Handle

New Breeze Rigid Riser Kit

Description	Code	£ Ex VAT	£ Inc VAT
New Breeze Rigid Riser Kit	97.0001	101.00	121.20

Pressure HP2 (2 bar minimum)

- Height 1073mm
- Includes single function handset, shower hose & outlet elbow
- Chrome finish

Shower Panels

SHOWER PANELS



HP2

3 In 1 Shower Panel With 3 Body Jet

Description	Code	£ Ex VAT	£ Inc VAT
3 in 1 Shower with 3 body jet	78.0008	282.00	338.40

Pressure HP2 (2 bar minimum)

- Height 1165mm
- Built-in diverter
- Can be fitted with BSM/Shower Valves
- Corner & flat wall fixing included



HP2

3 In 1 Shower Panel With 3 Body Jet

Description	Code	£ Ex VAT	£ Inc VAT
3 in 1 Shower with 3 body jet	78.0009	282.00	338.40

Pressure HP2 (2 bar minimum)

- Height 1165mm
- Built-in diverter
- Can be fitted with BSM/Shower Valves
- Corner & flat wall fixing included

CONWAY SHOWER PANEL

“The ultimate luxury in showering”



HP1

Conway Shower Panel

Description	Code	£ Ex VAT	£ Inc VAT
Conway Shower Panel	80.0001	300.00	360.00

Pressure HP2 (2 bar minimum)

- Height 1730mm
- Stainless steel

FEATURES

- Brushed stainless steel
- Includes thermostatic valve
- Easy installation
- Includes built-in body jets, fixed head & flexible handset

LP1 - 0.1 bar minimum

HP1 - 1 bar minimum

MP - 0.5 bar minimum

HP2 - 2 bar minimum

Rail Kits & Accessories

RAIL KITS



Curved X Slide Rail Kit			
Description	Code	£ Ex VAT	£ Inc VAT
Curved X Slide Rail Kit	78.0015	116.00	139.20

- Height 800mm
- Solid brass construction
- Chrome finish



Curved Mini Slide Rail Kit			
Description	Code	£ Ex VAT	£ Inc VAT
Curved Mini Slide Rail Kit	78.0016	63.00	75.60

- Height 680mm
- Stainless steel & brass construction
- Chrome finish



Rectangular Mini Slide Rail Kit			
Description	Code	£ Ex VAT	£ Inc VAT
Rectangular Mini Slide Rail Kit	78.0017	40.00	48.00

- Height 685mm
- Chrome finish



Rectangular X Slide Rail Kit			
Description	Code	£ Ex VAT	£ Inc VAT
Rectangular X Slide Rail Kit	78.0018	63.00	75.60

- Height 850mm
- Stainless steel & brass construction
- Chrome finish



Traditional Slide Rail Kit Chrome			
Description	Code	£ Ex VAT	£ Inc VAT
Traditional Slide Rail Kit only Chrome	93.0048	81.00	97.20

- Height 600mm
- Solid brass construction
- Chrome finish

Description	Code	£ Ex VAT	£ Inc VAT
Traditional Shower Handset	93.0069	20.00	24.00
1.5m Shower Flexible Hose - 8mm Bore	93.0061	8.00	9.60

93.0069

93.0061



Soap Holder			
Description	Code	£ Ex VAT	£ Inc VAT
Soap Holder	78.0036	7.00	8.40

- Only compatible with: 78.0016, 78.0017 & 78.0018

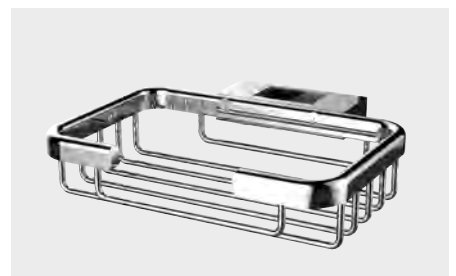

Soap Holder Chrome			
Description	Code	£ Ex VAT	£ Inc VAT
Soap Holder Chrome	78.0041	33.00	39.60

- Only compatible with: 78.0016, 78.0017 & 78.0018

Riser Kits & Shower Handsets

STRATFORD TRADITIONAL RISER KITS

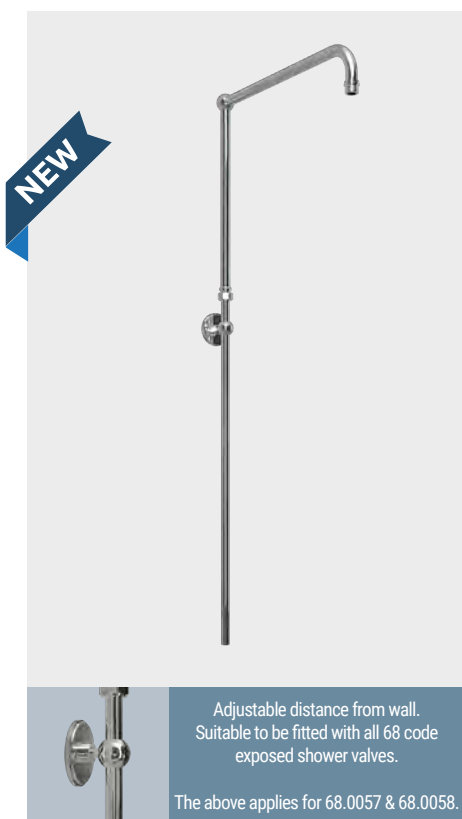

Adjustable distance from wall. Suitable to be fitted with all 68 code exposed shower valves.
The above applies for 68.0057 & 68.0058.

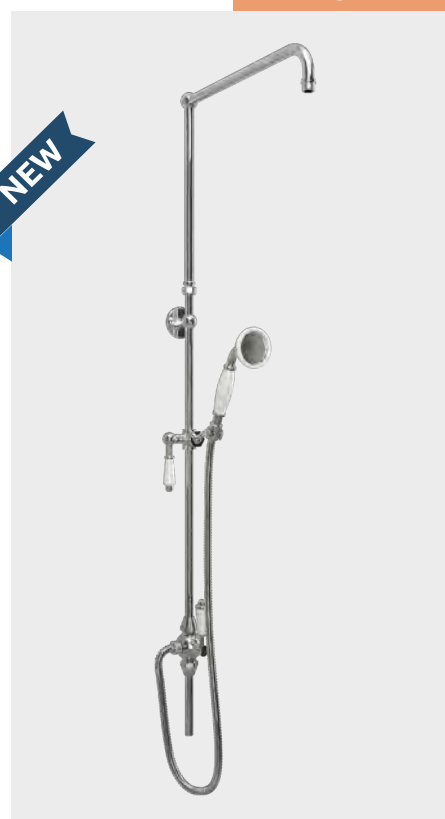

Stratford Traditional Riser Kit

Description	Code	£ Ex VAT	£ Inc VAT
Stratford Traditional Riser Kit	68.0057	90.00	108.00

- Adjustable height 843-1163mm
- Solid brass construction
- Chrome finish

Stratford Traditional Riser Kit with Diverter & Shower Kit

Description	Code	£ Ex VAT	£ Inc VAT
Stratford Traditional Riser Kit with Diverter & Shower Kit	68.0058	216.00	259.20

- Adjustable height 1041-1361 mm
- Solid brass construction
- Chrome/white finish

Please choose your shower valve and shower head below:

Compatible Shower Valves	Page Number	Compatible Shower Heads	Page Number
68.0018	655	98.0009	657
68.0047	656	98.0027	657
68.0048	656		
68.0049	655		
68.0051	653		

LED HANDSETS



68.0035/68.0036



68.0037/68.0038

LED Handsets

Description	Code	£ Ex VAT	£ Inc VAT
LED Handset vary colour†	68.0035	15.00	18.00
LED Handset temp sensing†	68.0036	17.00	20.40
LED Handset vary colour†	68.0037	15.00	18.00
LED Handset temp sensing†	68.0038	17.00	20.40

†While stocks last.

Shower Handsets

SHOWER HANDSETS

SPRAY TYPES



Full Spray



Spray/Massage



Oxygenic



Dot Massage



Strong Spray



Massage



Spray/Misty



Misty



Water Saving Drizzle



Spray/Dot Massage



Minimalist Square Handset

Code	£ Ex VAT	£ Inc VAT
98.0016	8.00	9.60

- Single function
- Chrome finish



Rectangular Shower Handset

Code	£ Ex VAT	£ Inc VAT
78.0038	26.00	31.20

- Solid brass construction
- Single function
- Chrome finish



Round Shower Handset

Code	£ Ex VAT	£ Inc VAT
78.0039	16.00	19.20

- Solid brass construction
- Single function
- Chrome finish

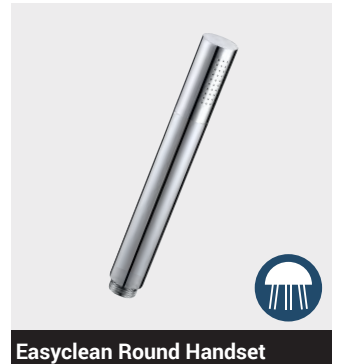

Easyclean Round Handset

Code	£ Ex VAT	£ Inc VAT
93.0059	11.00	13.20

- Comes apart for easy clean maintenance
- Solid brass construction
- Single function
- Chrome finish



Type 35 Shower Handset

Code	£ Ex VAT	£ Inc VAT
97.0021	7.00	8.40

- Single function
- Chrome finish



Type 40 Shower Handset

Code	£ Ex VAT	£ Inc VAT
97.0022	7.00	8.40

- Single function
- Chrome finish



Type 45 Shower Handset

Code	£ Ex VAT	£ Inc VAT
97.0023	9.00	10.80

- Single function
- Chrome finish



Type 50 Shower Handset

Code	£ Ex VAT	£ Inc VAT
97.0024	8.00	9.60

- Single function
- Chrome finish



Round Shower Handset

Code	£ Ex VAT	£ Inc VAT
78.0040	35.00	42.00

- Solid brass construction, chrome finish
- 2 functions



Shower Handsets

SHOWER HANDSETS

SPRAY TYPES



Full Spray



Spray/Massage



Oxygenic



Dot Massage



Strong Spray



Massage



Spray/Misty



Misty



Water Saving Drizzle



Spray/Dot Massage



Type 15 Shower Handset		
Code	£ Ex VAT	£ Inc VAT
97.0013	13.00	15.60

- 5 functions
- Chrome finish

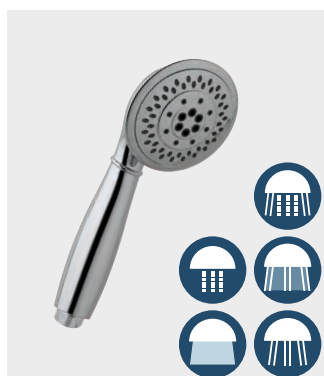

Type 60 Shower Handset		
Code	£ Ex VAT	£ Inc VAT
97.0009	12.00	14.40

- 5 functions
- Chrome finish

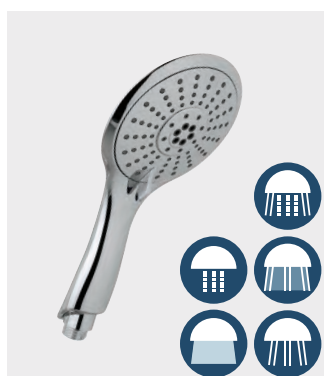

Type 65 Shower Handset		
Code	£ Ex VAT	£ Inc VAT
97.0016	13.00	15.60

- 5 functions
- Chrome finish

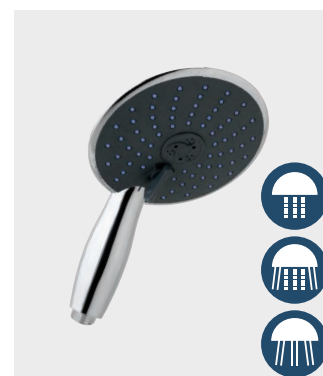

Type 70 Shower Handset		
Code	£ Ex VAT	£ Inc VAT
97.0017	16.00	19.20

- 3 functions
- Chrome finish



Type 75 Shower Handset		
Code	£ Ex VAT	£ Inc VAT
97.0020	17.00	20.40

- 4 functions
- Chrome finish



Type 80 Shower Handset		
Code	£ Ex VAT	£ Inc VAT
97.0019	11.00	13.20

- Single function
- Chrome finish

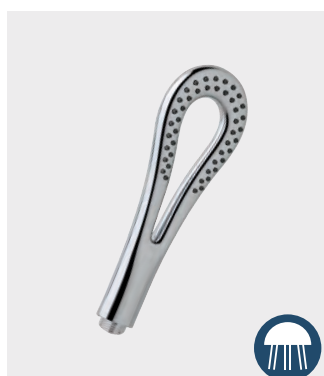

Needle Shower Handset		
Code	£ Ex VAT	£ Inc VAT
97.0018	9.00	10.80

- Single function
- Chrome finish

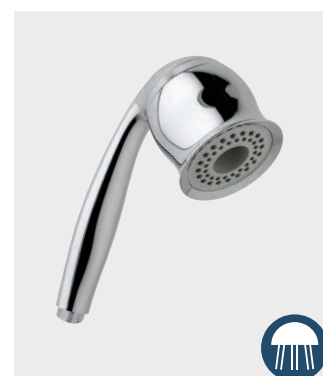

Type 85 Shower Handset		
Code	£ Ex VAT	£ Inc VAT
97.0011	14.00	16.80

- Single function
- Chrome finish



Type 90 Shower Handset		
Code	£ Ex VAT	£ Inc VAT
78.0037	68.00	81.60

- Single function
- Brass construction, white & chrome finish
- Ultra thin design



78.0037

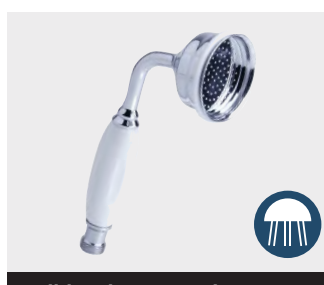

Traditional Type 10 Shower Handset		
Code	£ Ex VAT	£ Inc VAT
98.0015	17.00	20.40

- Single function
- White & chrome finish
- Traditional design

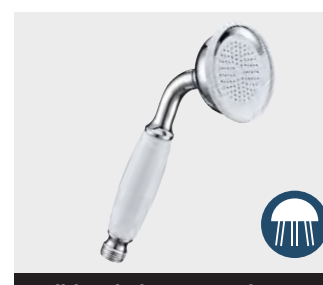

Traditional Shower Handset		
Code	£ Ex VAT	£ Inc VAT
93.0069	20.00	24.00

- Single function
- White & chrome finish
- Traditional design

Shower Handsets & Hoses

SHOWER HAND SET

SPRAY TYPES



Full Spray



Spray/Massage



Oxygenic



Dot Massage



Strong Spray



Massage



Spray/Misty



Misty



Water Saving Drizzle



Spray/Dot Massage



Type 95 Shower Handset Matt Smooth Black

Code	£ Ex VAT	£ Inc VAT
78.0051	15.00	18.00

- Single function
- Matt smooth black finish



Type 15 Shower Handset Matt Smooth Black

Code	£ Ex VAT	£ Inc VAT
78.0054	33.00	39.60

- Single function
- Matt smooth black finish
- Solid brass construction



Type 100 Shower Handset Matt Smooth Black

Code	£ Ex VAT	£ Inc VAT
78.0052	13.00	15.60

- Single function
- Matt smooth black finish

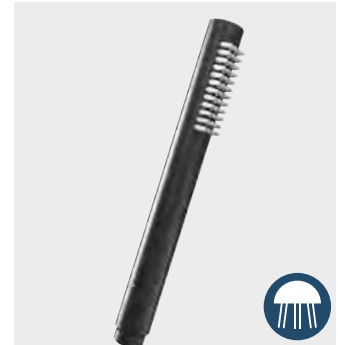

Type 20 Shower Handset Matt Smooth Black

Code	£ Ex VAT	£ Inc VAT
78.0055	31.00	37.20

- Single function
- Matt smooth black finish
- Solid brass construction

FLEXIBLE SHOWER HOSES



78.0054,
93.0102 &
93.0109



78.0055,
93.0102 &
93.0107

Flexible Shower Hoses

Description	Code	£ Ex VAT	£ Inc VAT
1.5m Shower Flexible Hose - 8mm Bore	93.0061	8.00	9.60
2m Shower Flexible Hose - 8mm Bore	93.0062	8.00	9.60
1.5m Shower Flexible Hose - 10mm Bore	93.0063	11.00	13.20
2m Shower Flexible Hose - 10mm Bore	93.0064	12.00	14.40
1.5m PVC Shower Hose Matt Smooth Black - 6mm Bore	93.0102	11.00	13.20
2m PVC Shower Hose Matt Smooth Black - 6mm Bore	93.0103	13.00	15.60



93.0061 & 93.0063
8mm & 10mm Bore



93.0062 & 93.0064
8mm & 10mm Bore



93.0102 6mm bore



93.0103 6mm bore

Wall & Ceiling Mounted Showers

WALL MOUNTED WATERFALL SHOWERS



78.0006

HP1.5

Wall-Mounted Shower With Waterfall

Stainless steel wall-mounted double outlet shower heads with rainfall and waterfall features.

Description	Code	£ Ex VAT	£ Inc VAT
Wall-mounted shower with waterfall	78.0007	450.00	540.00

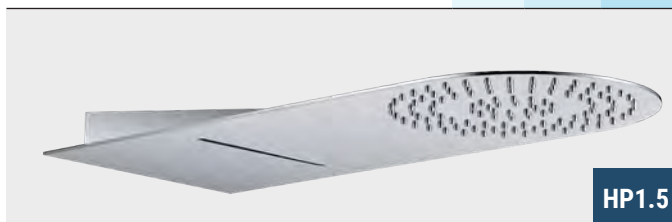

HP1.5

Wall-Mounted Shower With Waterfall

Description	Code	£ Ex VAT	£ Inc VAT
Wall-mounted shower with waterfall	78.0006	435.00	522.00

- Stainless steel construction
- Wall mounted
- Waterfall outlet
- Rainfall outlet

Requires fixing to a substantial fixing point.
Requires a diverter shower valve.



HP1.5

CEILING MOUNTED WATERFALL SHOWERS



78.0030

HP1.5

Waterfall Shower Ceiling Mounted - Single

Stainless steel ceiling-mounted shower with rainfall and waterfall features.

Description	Code	£ Ex VAT	£ Inc VAT
Waterfall Shower Ceiling Mounted - Single	78.0029	615.00	738.00

FEATURES

- Stainless steel construction
- Flush ceiling fitting
- Single waterfall outlet
- Rainfall outlet

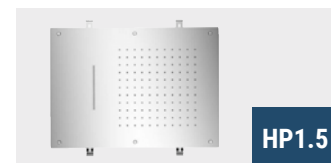
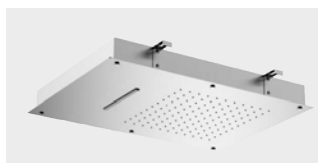

HP1.5

Waterfall Shower Ceiling Mounted - Double

Description	Code	£ Ex VAT	£ Inc VAT
Waterfall Shower Ceiling Mounted - Double	78.0030	663.00	795.60

FEATURES

- Stainless steel construction
- Flush ceiling fitting
- Double waterfall outlet
- Rainfall outlet

Requires fixing to a substantial fixing point.
Requires a diverter shower valve.

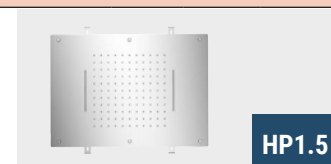
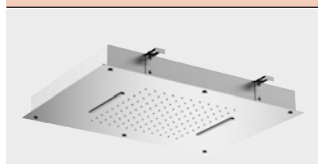

HP1.5

HP1.5 - 1.5 bar minimum

Shower Arms

CEILING MOUNTED SHOWER ARMS

Ceiling Mounted Shower Arms			
Description	Code	£ Ex VAT	£ Inc VAT
Round Shower Arm 150mm Chrome	93.0114	16.00	19.20
Round Shower Arm 150mm Matt Smooth Black	93.0115	18.00	21.60
Square Shower Arm 200mm Chrome	78.0010	24.00	28.80
Round Shower Arm 200mm Chrome	78.0011	18.00	21.60
Round Shower Arm 200mm Matt Smooth Black	78.0045	23.00	27.60



WALL MOUNTED SHOWER ARMS

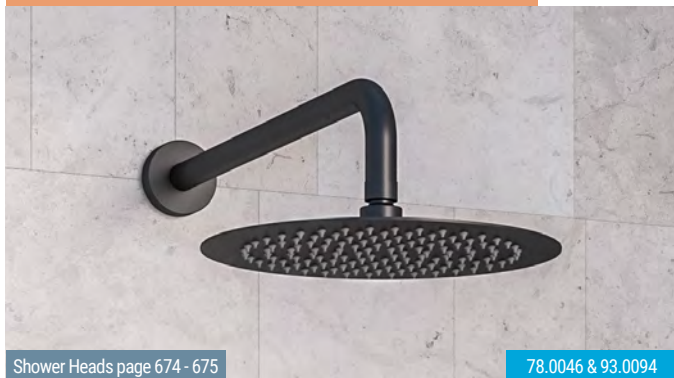

Round Offset Shower Arm Matt Smooth Black

Description	Code	£ Ex VAT	£ Inc VAT
Round Offset Shower Arm Matt Smooth Black	78.0046	36.00	43.20

- Outlet to wall 400mm
- Solid brass construction



Round Offset Shower Arm Ø22 x 400mm

Description	Code	£ Ex VAT	£ Inc VAT
Round Offset Shower Arm Ø22 x 400mm	78.0012	27.00	32.40

- Outlet to wall 400mm
- Solid brass construction, chrome finish

Wall Mounted Arm 200mm

Code	£ Ex VAT	£ Inc VAT
98.0025	15.00	18.00

Round Wall Arm

Code	£ Ex VAT	£ Inc VAT
78.0022	28.00	33.60

Wall Mounted Arm 345mm

Code	£ Ex VAT	£ Inc VAT
98.0024	18.00	21.60

- Outlet to wall 200mm
- Solid brass construction, chrome finish

- Outlet to wall 400mm
- Solid brass construction, chrome finish

- Outlet to wall 345mm
- Solid brass construction, chrome finish

Shower Arms

WALL MOUNTED SHOWER ARMS

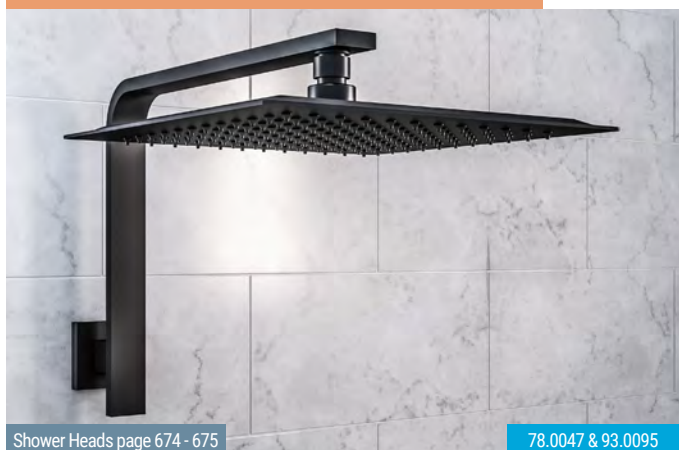

Shower Heads page 674 - 675

78.0047 & 93.0095



Shower Heads page 674 - 675

78.0020 & 78.0005



Square L Shower Arm Matt Smooth Black

Description	Code	£ Ex VAT	£ Inc VAT
Square L Shower Arm	78.0047	98.00	117.60

- Outlet to wall 360mm
- Solid brass construction



Square X Shower Arm

Description	Code	£ Ex VAT	£ Inc VAT
Square X Shower Arm	78.0019	83.00	99.60

- Outlet to wall 370mm
- Solid brass construction, chrome finish



Square Wall Arm

Description	Code	£ Ex VAT	£ Inc VAT
Square Wall Arm	78.0020	62.00	74.40

- Outlet to wall 360mm
- Solid brass construction

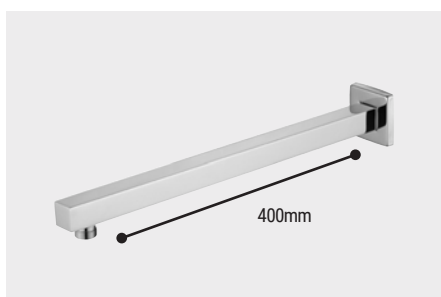

Square Wall Arm

Description	Code	£ Ex VAT	£ Inc VAT
Square Wall Arm	78.0021	45.00	54.00

- Outlet to wall 400mm
- Solid brass construction, chrome finish



Shower Arm

Description	Code	£ Ex VAT	£ Inc VAT
Shower Arm	98.0026	41.00	49.20

- Outlet to wall 172mm
- Solid brass construction, chrome finish



Square Wall Mounted Arm 200mm

Description	Code	£ Ex VAT	£ Inc VAT
Square Wall Mounted Arm	98.0023	25.00	30.00

- Outlet to wall 200mm
- Solid brass construction, chrome finish



Swivel Shower Arm Chrome

Description	Code	£ Ex VAT	£ Inc VAT
Swivel Shower Arm Chrome	93.0101	46.00	55.20

- Solid brass construction, chrome finish
- Outlet to wall 402mm

Choose your shower arm from above and then see pages 674-675 for compatible shower heads.



93.0101 & 98.0009

Shower Heads

SHOWER HEADS

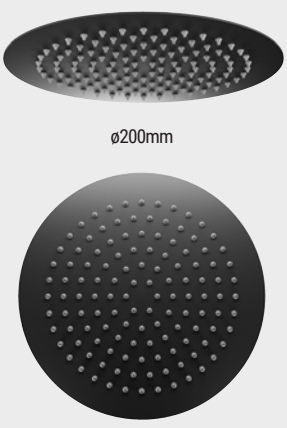

ø200mm

93.0094 **MP**

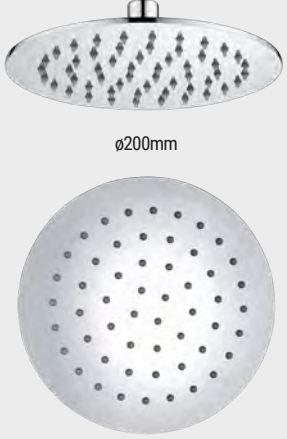

ø200mm

78.0001 **MP**

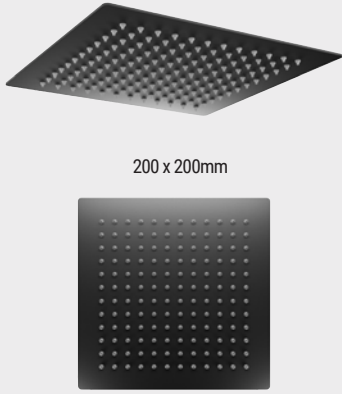

200 x 200mm

93.0095 **MP**

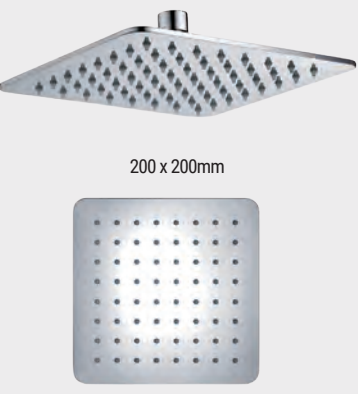

200 x 200mm

78.0003 **MP**

Shower Head Matt Smooth Black Finish

Description	Code	£ Ex VAT	£ Inc VAT
Round Shower Head Matt Smooth Black	93.0094	54.00	64.80
Square Shower Head Matt Smooth Black	93.0095	60.00	72.00

Shower Head Chrome Finish

Description	Code	£ Ex VAT	£ Inc VAT
8" Square shower head	78.0003	60.00	72.00
8" Round shower head	78.0001	54.00	64.80

- FEATURES**
- Brass construction
 - Matt smooth black finish
 - Rainfall outlet

- FEATURES**
- Stainless steel one piece construction
 - Polished (chrome effect) finish
 - Rainfall outlet
 - 4mm thickness

Pressure MP (0.5 bar minimum)

Pressure MP (0.5 bar minimum)

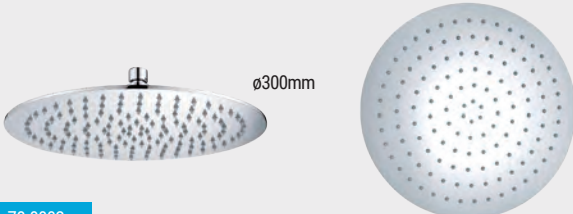

ø300mm

78.0002 **MP**

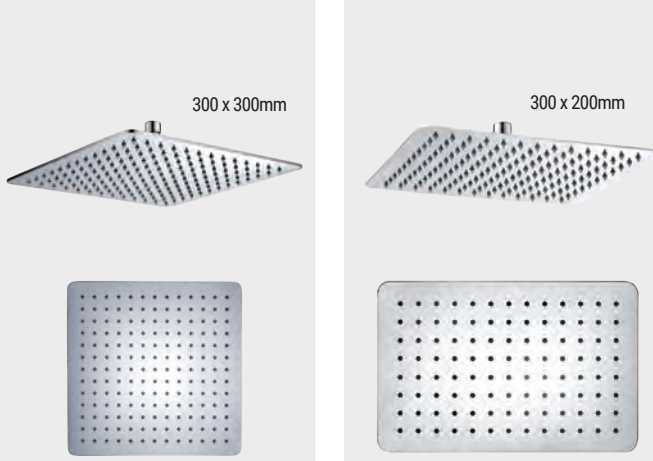

300 x 300mm

300 x 200mm

78.0004 **MP**

78.0005 **MP**

Shower Heads

Description	Code	£ Ex VAT	£ Inc VAT
12" Round shower head	78.0002	124.00	148.80
12" Square shower head	78.0004	137.00	164.40
8" x 12" Rectangle shower head	78.0005	105.00	126.00

- FEATURES**
- Stainless steel one piece construction
 - Polished (chrome effect) finish
 - Rainfall outlet
 - 4mm thickness

MP - 0.5 bar minimum

Pressure MP (0.5 bar minimum)

Shower Heads

SHOWER HEADS

SPRAY TYPES



Full Spray



Spray/Massage



Oxygenic



Dot Massage



Strong Spray



Massage



Spray/Misty



Misty



Water Saving Drizzle



Spray/Dot Massage



Type 10 Shower Head		
Code	£ Ex VAT	£ Inc VAT
97.0010	10.00	12.00

- Chrome plated
- 5 functions



Type 15 Shower Head		
Code	£ Ex VAT	£ Inc VAT
97.0012	16.00	19.20

- Chrome plated
- 2 functions



Type 20 Shower Head		
Code	£ Ex VAT	£ Inc VAT
97.0014	10.00	12.00

- Chrome plated
- 5 functions



Type 25 Shower Head		
Code	£ Ex VAT	£ Inc VAT
97.0015	13.00	15.60

- Chrome plated
- 5 functions



Type 30 Shower Head		
Code	£ Ex VAT	£ Inc VAT
97.0025	20.00	24.00

- Chrome plated
- Single function / 9" shower head



Type 35 Shower Head		
Code	£ Ex VAT	£ Inc VAT
97.0026	37.00	44.40

- Chrome plated
- Single function / 10" shower head



Type 40 Shower Head		
Code	£ Ex VAT	£ Inc VAT
97.0027	33.00	39.60

- Chrome plated
- Single function / 11" shower head



Type 45 Shower Head		
Code	£ Ex VAT	£ Inc VAT
97.0028	37.00	44.40

- Chrome plated
- 2 functions / 10" shower head

Compatible Traditional Riser Kit 'Stratford' Page 667

ø200mm

MP

98.0009 Tec 8" Fixed Head			
Description	Code	£ Ex VAT	£ Inc VAT
Tec 8" Fixed Head	98.0009	71.00	85.20

Compatible Traditional Riser Kit 'Stratford' Page 667

ø152mm

MP

NEW

98.0027 Tec 6" Fixed Head			
Description	Code	£ Ex VAT	£ Inc VAT
Tec 6" Fixed Head*	98.0027	62.00	74.40

ø200mm

MP

93.0051 Traditional 8" Shower Rose & Arm Chrome			
Description	Code	£ Ex VAT	£ Inc VAT
Traditional 8" Shower Rose & Arm Chrome	93.0051	29.00	34.80

- Solid brass construction, chrome finish

- Solid brass construction, chrome finish

- Includes shower arm, chrome finish

*Available November 2019

Outlet Elbows & Wall Brackets

OUTLET ELBOWS



97.0008



97.0007



93.0097



93.0096

Outlet Elbows			
Description	Code	£ Ex VAT	£ Inc VAT
Square Outlet Elbow Chrome finish	97.0008	18.00	21.60
Round Outlet Elbow Chrome finish	97.0007	14.00	16.80
Square Outlet Elbow Matt Smooth Black	93.0097	25.00	30.00
Round Outlet Elbow Matt Smooth Black	93.0096	22.00	26.40

- FEATURES**
- Solid brass construction

OUTLET ELBOWS WITH SHOWER BRACKETS



93.0104



93.0106



93.0105



93.0107

Outlet Elbow With Shower Brackets			
Description	Code	£ Ex VAT	£ Inc VAT
Square Outlet Elbow with bracket Chrome finish	93.0104	23.00	27.60
Round Outlet Elbow with bracket Chrome finish	93.0106	18.00	21.60
Square Outlet Elbow Matt Smooth Black	93.0105	26.00	31.20
Round Outlet Elbow Matt Smooth Black	93.0107	22.00	26.40

- FEATURES**
- Solid brass construction

HANDSET WALL BRACKETS



Luxury Wall Bracket		
Code	£ Ex VAT	£ Inc VAT
93.0058	5.00	6.00

- Chrome plated ABS



Square Shower Holder		
Code	£ Ex VAT	£ Inc VAT
78.0024	20.00	24.00

- Chrome plated brass body



Round Shower Holder		
Code	£ Ex VAT	£ Inc VAT
78.0025	17.00	20.40

- Chrome plated brass body



Oval Shower Holder		
Code	£ Ex VAT	£ Inc VAT
78.0026	17.00	20.40

- Chrome plated brass body

Body Jets & Shower Seats

BODY JETS



Body Jets: 78.0031 x6. Valve: 68.0004, 68.0024 & 68.0046 x3

Body Jets

Description	Code	£ Ex VAT	£ Inc VAT
Square Body Jet 2" Exposed	78.0031	21.00	25.20
Round Body Jet 2" Exposed	78.0032	20.00	24.00
Square Body Jet 5" Concealed	78.0033	58.00	69.60
Round Body Jet 5" Concealed	78.0034	53.00	63.60

†While stocks last.

FEATURES

- Solid brass construction
- Chrome finish
- Single function
- 4mm thickness



78.0031

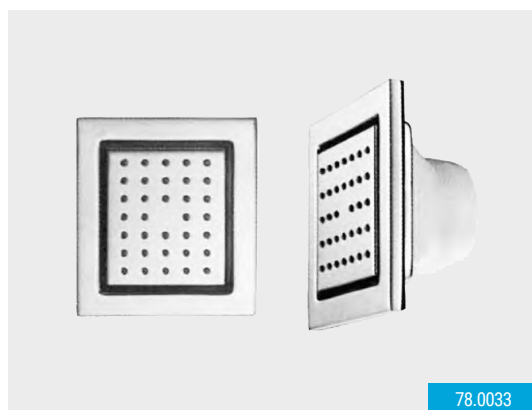

78.0033



78.0032

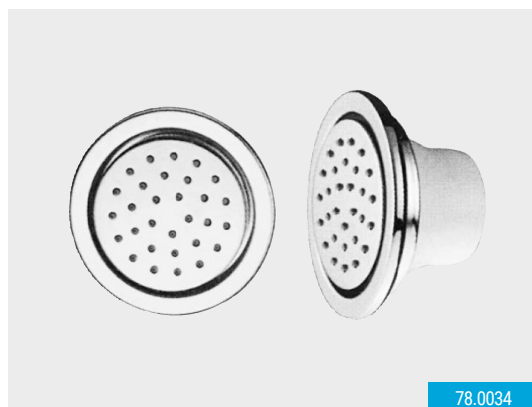

78.0034



41.3000

41.3000 Pressure reducing valve is suitable for water temperature up to 80°C and inlet pressures up to 16 bar. The outlet pressure can be adjusted between 1 bar and 6 bar. Typically these valves are used on the incoming water supply.

Pressure Reducing Valve

Description	Code	£ Ex VAT	£ Inc VAT
Pressure Reducing Valve 15mm x 15mm	41.3000	44.00	52.80

SHOWER SEAT



*Seat weight tolerance 15 stone

Shower Seat

Description	Code	£ Ex VAT	£ Inc VAT
Shower seat 500mm x 345mm	98.0021	224.00	268.80

FEATURES

- Solid wood seat



Taps

The following range of taps cater for all tastes, making it easy to complete your perfect room.

Contents

Side valves & bath fillers	680 - 681
Prado range	682 - 691
Contemporary and modern taps	692 - 709
Traditional taps	710 - 713
Kitchen taps	713
Wastes, levers and accessories	714 - 716



Side Valves & Bath Fillers

Side Valves - Deck Mounted Only

Description	Code	£ Ex VAT	£ Inc VAT
Valves with Braided Hose†	68.0040	82.00	98.40
Round Side Valve Handle**	68.0041	46.00	55.20
Square Side Valve Handle**	68.0042	59.00	70.80
Round Lever Side Valve Handle**	68.0043	44.00	52.80
Traditional Cross Handle Side Valve Handle**	68.0044	46.00	55.20
Traditional Lever Handle Side Valve Handle**	68.0045	53.00	63.60

** Must be fitted with 68.0040.

†To be fitted with 68.0041, 68.0042, 68.0043, 68.0044, 68.0045 only.
Ceramic disc technology.

MP



68.0041

Deck mounted only

MP



68.0044

Deck mounted only

MP



68.0045

Deck mounted only

MP



68.0043

Deck mounted only

MP



68.0042

Deck mounted only

Side Valves - Deck Or Wall Mounted

Description	Code	£ Ex VAT	£ Inc VAT
Prado Cylinder Side Valves*	79.0039	75.00	90.00
Prado Star Side Valves*	79.0049	78.00	93.60
Prado Lever Side Valves*	79.0059	70.00	84.00

*Can be wall mounted or deck mounted. Ceramic disc technology.

Required minimum operating pressure key

MP

- 0.5 bar minimum

MP



79.0039

Deck or wall mounted

MP



79.0049

Deck or wall mounted

MP



79.0059

Deck or wall mounted

Side Valves & Bath Fillers

93.0035 Requires a shower or side valve



Bath Filler

Description	Code	£ Ex VAT	£ Inc VAT
Square Waterfall bath Filler inc waste Chrome	93.0035	80.00	96.00

93.0036 Requires a shower or side valve



Bath Filler

Description	Code	£ Ex VAT	£ Inc VAT
Round Waterfall bath Filler inc waste Chrome	93.0036	70.00	84.00

93.0037 Wall mounted bath filler
Requires a shower or side valve



MP

Bath Filler

Description	Code	£ Ex VAT	£ Inc VAT
Waterfall Bath Filler Chrome	93.0037	74.00	88.80

78.0028 Wall mounted bath filler
Requires a shower or side valve



Bath Filler

Description	Code	£ Ex VAT	£ Inc VAT
Waterfall Bath Spout	78.0028	51.00	61.20

78.0027 Wall mounted bath filler
Requires a shower or side valve



Bath Filler

Description	Code	£ Ex VAT	£ Inc VAT
Waterfall Bath Filler	78.0027	61.00	73.20

2.015 Requires a shower or side valve



Bath Filler

Description	Code	£ Ex VAT	£ Inc VAT
Shallow Profile Bath Filler	2.015	204.00	244.80

68.0039 Requires a shower or side valve



Bath Filler

Description	Code	£ Ex VAT	£ Inc VAT
Bath Filler & Waste	68.0039	134.00	160.80

Prado 600 Range

PRADO 600

MP

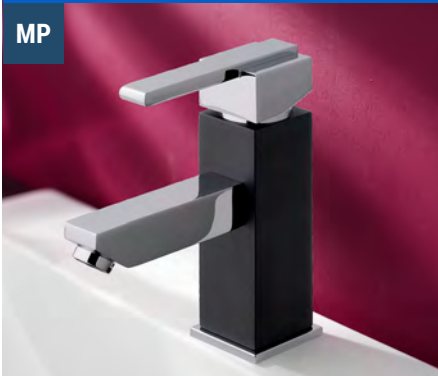

79.0074

Bath filler delivers over 50 litres a minute at 3 bar supply

Prado 600

Description	Chrome	£ Ex VAT	£ Inc VAT	Black/Chrome	£ Ex VAT	£ Inc VAT
Prado 600 Basin Mono (inc Waste)	79.0066	80.00	96.00	79.0074†	89.00	106.80
Prado 600 High Flow 1TH Bath Filler	79.0068	101.00	121.20	79.0076†	106.00	127.20
Prado 600 Extended Mono Basin	79.0069	108.00	129.60	79.0077†	108.00	129.60
Prado 600 BSM (inc Kit)	79.0070	167.00	200.40	79.0078†	168.00	201.60
Prado 600 Bath Filler	79.0071	138.00	165.60	79.0079†	151.00	181.20
Prado 600 1/4 Turn Basin Taps	79.0072	94.00	112.80	79.0080†	98.00	117.60
Prado 600 1/4 Turn Bath Taps	79.0073	95.00	114.00	79.0081†	99.00	118.80

†While stocks last.

Required minimum operating pressure key

MP - 0.5 bar minimum

LP1 - 0.1 bar minimum

MP



79.0077

MP



79.0078

MP



79.0081

MP



79.0066

MP



79.0069

MP

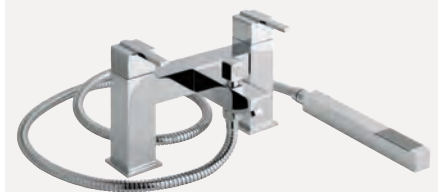

79.0070

LP1



79.0068

MP



79.0071

MP



79.0072

MP



79.0073

Prado Star Range

PRADO STAR



Prado Star				
Description	Colour	Code	£ Ex VAT	£ Inc VAT
Prado Star Basin Mono Swivel Spout (inc Waste)	Chrome	79.0040	86.00	103.20
Prado Star Bath Filler	Chrome	79.0042	128.00	153.60
Prado Star BSM (inc Kit)**	Chrome	79.0043	160.00	192.00
Prado Star 4 Hole Deck BSM	Chrome	79.0044	162.00	194.40
Prado Star 3 Hole Deck Basin Mixer	Chrome	79.0045	121.00	145.20
Prado Star 3 Hole Bath Filler	Chrome	79.0046	121.00	145.20
Prado Star 3 Hole Wall Mounted Mixer	Chrome	79.0047	82.00	98.40
Prado Star 3 Hole Wall Mounted Bath Filler	Chrome	79.0048	83.00	99.60
Prado Star Side Valves*	Chrome	79.0049	78.00	93.60

*Can be wall mounted or deck mounted. Ceramic disc technology.
 **Wall brackets and slide rail kit sold separately.

Required minimum operating pressure key

MP - 0.5 bar minimum

For Overflow Fillers
see page 681



Wall or deck
mounted

Prado Cylinder Range

PRADO CYLINDER

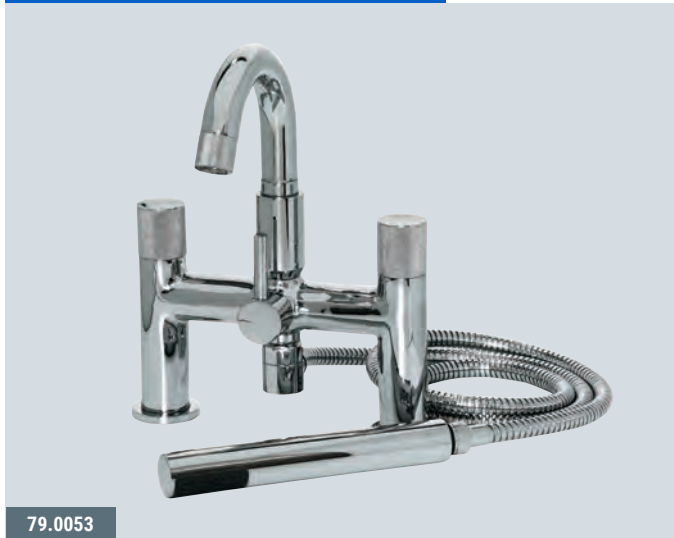

79.0053

Prado Cylinder

Description	Colour	Code	£ Ex VAT	£ Inc VAT
Prado Cylinder Basin Mono (inc Waste)	Chrome	79.0050	86.00	103.20
Prado Cylinder Bath Filler	Chrome	79.0052	128.00	153.60
Prado Cylinder BSM (inc Kit)**	Chrome	79.0053	160.00	192.00
Prado Cylinder 4 Hole Deck BSM	Chrome	79.0054	162.00	194.40
Prado Cylinder 3 Hole Deck Basin Mixer	Chrome	79.0055	121.00	145.20
Prado Cylinder 3 Hole Bath Filler	Chrome	79.0056	121.00	145.20
Prado Cylinder 3 Hole Wall Mounted Basin Mixer	Chrome	79.0057	82.00	98.40
Prado Cylinder 3 Hole Wall Mounted Bath Filler	Chrome	79.0058	83.00	99.60
Prado Cylinder Side Valves*	Chrome	79.0039	75.00	90.00

*Can be wall mounted or deck mounted. Ceramic disc technology.

**Wall brackets and slide rail kit sold separately.

Required minimum operating pressure key

MP - 0.5 bar minimum

For Overflow Fillers
see page 681

MP



79.0050

MP



79.0052

MP



79.0054

MP



79.0055

MP



79.0056

MP



79.0057

MP



79.0039

Wall or deck
mounted

MP



79.0058

Prado Lever Range

PRADO LEVER



79.0033

Prado Lever				
Description	Colour	Code	£ Ex VAT	£ Inc VAT
Prado Lever Basin Mono Swivel Spout (inc Waste)	Chrome	79.0030	86.00	103.20
Prado Lever Bath Filler	Chrome	79.0032	130.00	156.00
Prado Lever BSM (inc Kit)**	Chrome	79.0033	161.00	193.20
Prado Lever 4 Hole Deck BSM	Chrome	79.0034	165.00	198.00
Prado Lever 3 Hole Deck Basin Mlxxer	Chrome	79.0035	132.00	158.40
Prado Lever 3 Hole Bath Filler	Chrome	79.0036	132.00	158.40
Prado Lever 3 Hole Wall Mounted Basin Mixer	Chrome	79.0037	86.00	103.20
Prado Lever 3 Hole Wall Mounted Bath Filler	Chrome	79.0038	87.00	104.40
Prado Lever Side Valves*	Chrome	79.0059	70.00	84.00

*Can be wall mounted or deck mounted. Ceramic disc technology.
 **Wall brackets and slide rail kit sold separately.

Required minimum operating pressure key

MP - 0.5 bar minimum

For Overflow Fillers
see page 681

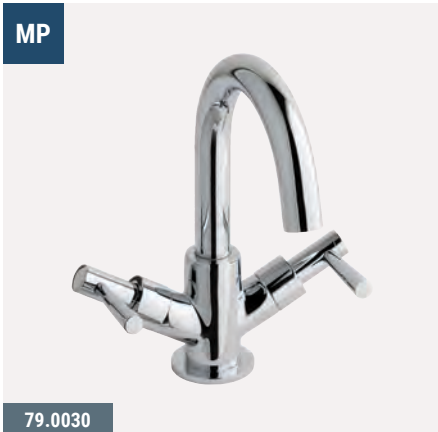

MP

79.0030



MP

79.0032



MP

79.0034



MP

79.0035



MP

79.0036



MP

79.0037



MP

79.0038



MP

79.0059

Wall or deck
mounted

Prado 500 Range

PRADO 500

LP1



79.0062

Bath filler delivers over 50 litres a minute at 3 bar supply

Prado 500

Description	Colour	Code	£ Ex VAT	£ Inc VAT
Prado 500 Basin Mono (inc Waste)	Chrome	79.0060	63.00	75.60
Prado 500 1TH Bath Filler	Chrome	79.0062	95.00	114.00
Prado 500 Extended Mono Basin	Chrome	79.0063	78.00	93.60
Prado 500 BSM (inc Kit)	Chrome	79.0064	137.00	164.40
Prado 500 Bath Filler*	Chrome	79.0065	113.00	135.60

*Wall brackets and slide rail kit sold separately. Ceramic disc technology.

Pressure (bar) for 79.0062	Flow (litres/min) for 79.0062
0.1	9
0.5	18
1	29
2	43
3	51

Note: Pressure based on an open ended valve outlet without downstream resistance. Applies to bath filler only.

Required minimum operating pressure key

LP1

- 0.1 bar minimum

MP

- 0.5 bar minimum

MP



79.0060

MP



79.0063

MP



79.0064

MP



79.0065

Prado 650 & 580 Range



PRADO 650

Prado 650

Description	Code	£ Ex VAT	£ Inc VAT
Prado 650 mono basin c/w click waste	56.2005	96.00	115.20
Prado 650 mono bidet c/w click waste	56.2006	96.00	115.20
Prado 650 high rise mono basin	56.2007	123.00	147.60
Prado 650 bath filler	56.2008	166.00	199.20
Prado 650 BSM inc kit*	56.2009	175.00	210.00
Minimalist Square Handset	98.0016	8.00	9.60

*Wall brackets sold separately. Ceramic disc technology.

Pressure (bar)	Flow (litres/min)	
	Bath Filler (56.2008)	BSM (56.2009)
0.1	4.8	4.6
0.5	10.1	9
1	15.6	14
2	22.5	20.4
3	28	25.4

Note: Pressure based on an open ended valve outlet without downstream resistance. Applies to bath filler only.

Required minimum operating pressure key

MP - 0.5 bar minimum

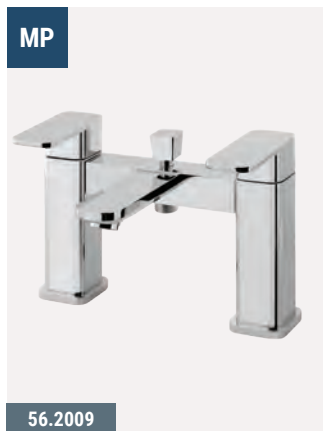
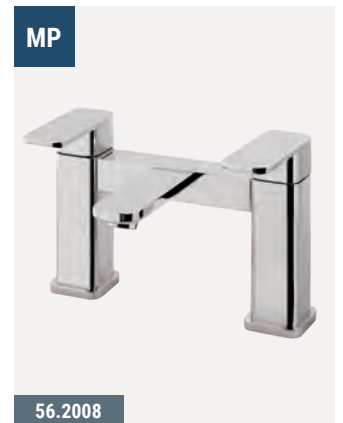

PRADO 580



Description	Code	£ Ex VAT	£ Inc VAT
Prado 580 Mono Hi Flow Bath Filler	56.2027	170.00	204.00

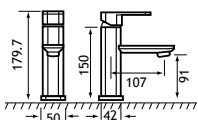

56.2005

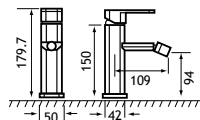

56.2006

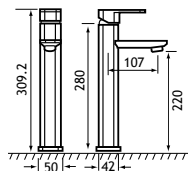

56.2007

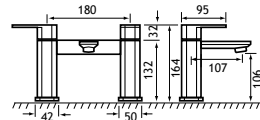

56.2008

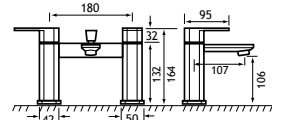

56.2009

Prado 700 Range

PRADO 700



56.2010

Prado 700

Description	Code	£ Ex VAT	£ Inc VAT
Prado 700 mono basin c/w click waste	56.2010	95.00	114.00
Prado 700 mono bidet c/w click waste	56.2011	95.00	114.00
Prado 700 high rise mono basin	56.2012	125.00	150.00
Prado 700 bath filler	56.2013	149.00	178.80
Prado 700 BSM inc kit*	56.2014	158.00	189.60
Minimalist Square Handset	98.0016	8.00	9.60

*Wall brackets sold separately. Ceramic disc technology.

Required minimum operating pressure key

MP - 0.5 bar minimum

Pressure (bar)	Flow (litres/min)	
	Bath Filler (56.2013)	BSM (56.2014)
0.1	4.8	4.6
0.5	10.1	9
1	15.6	14
2	22.5	20.4



MP

56.2010



MP

56.2011



MP

56.2012



MP

56.2013



MP

56.2014



MP

98.0016

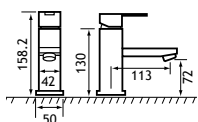

56.2010

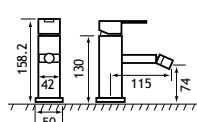

56.2011

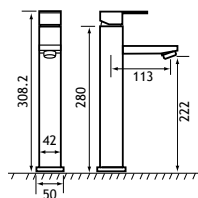

56.2012

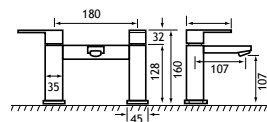

56.2013

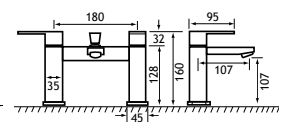

56.2014

Prado 550 Range

PRADO 550



56.2000

Prado 550

Description	Code	£ Ex VAT	£ Inc VAT
Prado 550 mono basin c/w clicker waste	56.2000	84.00	100.80
Prado 550 mono bidet c/w clicker waste	56.2001	84.00	100.80
Prado 550 high rise mono basin	56.2002	95.00	114.00
Prado 550 bath filler	56.2003	123.00	147.60
Prado 550 BSM inc kit*	56.2004	129.00	154.80

*Wall brackets sold separately. Ceramic disc technology.

Required minimum operating pressure key

MP	- 0.5 bar minimum	Flow (litres/min)	
		Bath Filler (56.2003)	BSM (56.2004)
		0.1	4.8
		0.5	10.1
		1	15.6
		2	22.5



56.2000



56.2001



56.2002

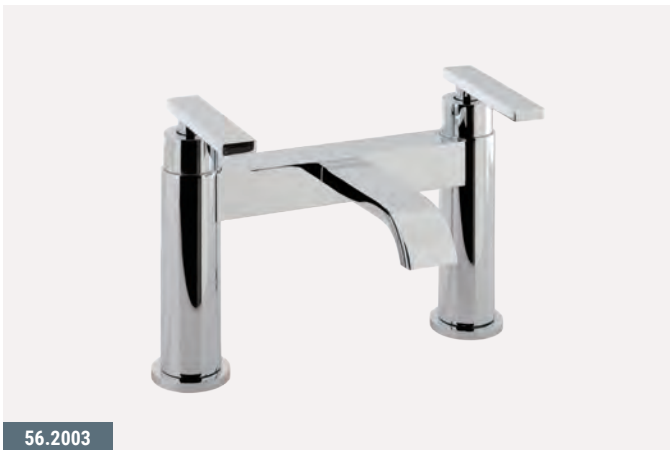

56.2003



56.2004

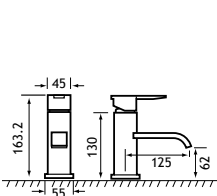

56.2000

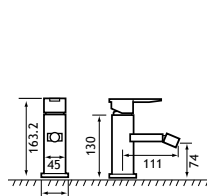

56.2001

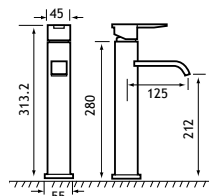

56.2002

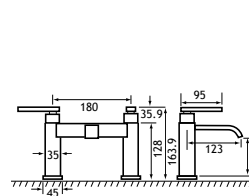

56.2003

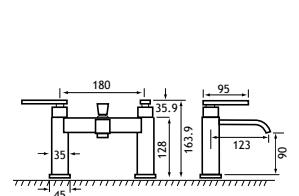

56.2004

Prado 800 & 100 Range

PRADO 800



56.2015

Prado 800			
Description	Code	£ Ex VAT	£ Inc VAT
Prado 800 mono basin c/w click waste	56.2015	82.00	98.40
Prado 800 mono bidet c/w click waste	56.2016	82.00	98.40
Prado 800 high rise mono basin	56.2017	95.00	114.00
Prado 800 bath filler	56.2018	125.00	150.00
Prado 800 BSM inc kit*	56.2019	132.00	158.40

*Wall brackets sold separately. Ceramic disc technology.

Required minimum operating pressure key

LP1 - 0.1 bar minimum

MP - 0.5 bar minimum

LP2 - 0.2 bar minimum

HP1 - 1 bar minimum

MP



56.2015

BSM KIT

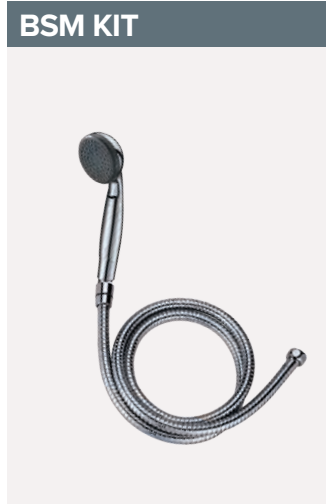

MP



56.2018

MP



56.2019

MP



56.2016

MP



56.2017

PRADO 100

HP1



56.2025

Prado 100			
Description	Code	£ Ex VAT	£ Inc VAT
Prado 100 mono basin c/w click waste	56.2025	45.00	54.00

Note: Minimum recommended pressure 1.0 bar. Ceramic disc technology.

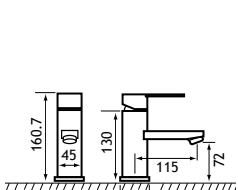

56.2015

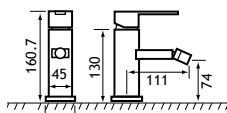

56.2016

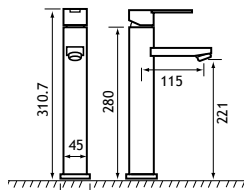

56.2017

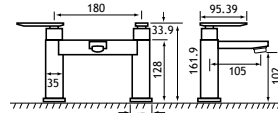

56.2018

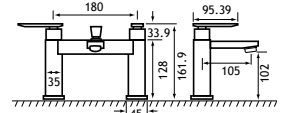

56.2019

Prado 300 & Camborne Range

Prado 300		WAS	NOW JUST	
Description	Code	£ Ex VAT	£ Ex VAT	£ Inc VAT
Prado 300 BSM inc kit	56.2024	75.00	63.00	75.60

MP



56.2024

PRADO 300			
Description	Code	£ Ex VAT	£ Inc VAT
Prado 300 bath filler	56.2023	62.00	74.40

MP



56.2023

CAMBORNE

Camborne Basin Mono			
Description	Code	£ Ex VAT	£ Inc VAT
Camborne Basin Mono (inc waste) Chrome	93.0004	102.00	122.40

MP



93.0004

Waterfall Tap



93.0004

Pressure (bar)	Flow (litres/min)	
	Bath Filler (93.0005)	BSM (93.0006)
0.1	11.2	9.3
0.5	22.9	19.5
1	32.1	27.5
2	45.3	39.2
3	55.4	48.2

Note: Pressure based on an open ended valve outlet without downstream resistance.

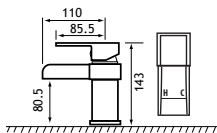

93.0004

Camborne Bath Filler			
Description	Code	£ Ex VAT	£ Inc VAT
Camborne Bath Filler Chrome	93.0005	155.00	186.00

MP



93.0005

Waterfall Tap

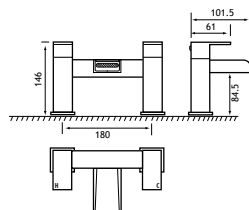

93.0005

Camborne BSM Inc Kit			
Description	Code	£ Ex VAT	£ Inc VAT
Camborne BSM inc kit Chrome	93.0006	175.00	210.00

MP



93.0006

Waterfall Tap

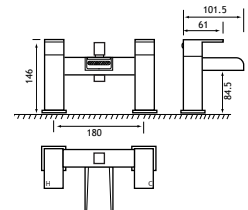

93.0006

Ceramic disc technology on all products within range.

Falmouth & Wendover Range

FALMOUTH

Falmouth Basin Mono

Description	Code	£ Ex VAT	£ Inc VAT
Falmouth Basin Mono (inc waste) Chrome	93.0001	104.00	124.80



Falmouth Bath Filler

Description	Code	£ Ex VAT	£ Inc VAT
Falmouth wall mounted Bath Filler Chrome	93.0002	154.00	184.80



Falmouth Wall Mounted BSM Kit

Description	Code	£ Ex VAT	£ Inc VAT
Falmouth wall mounted BSM inc kit Chrome	93.0003	171.00	205.20



Pressure (bar)	Flow (litres/min)		Note: Pressure based on an open ended valve outlet without downstream resistance.
	Bath Filler (93.0002)	BSM (93.0003)	
1	7.8	7.9	
2	11	11.3	
3	13.2	13.8	

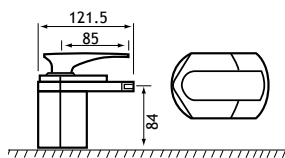

93.0001

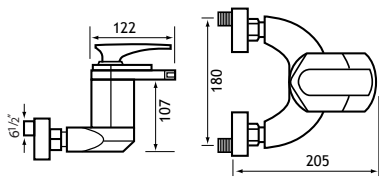

93.0002

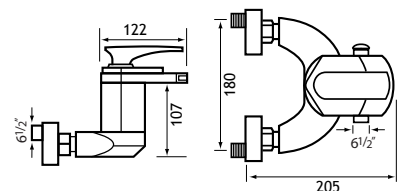

93.0003

WENDOVER



Wendover

Description	Code	£ Ex VAT	£ Inc VAT
Wendover Basin Mono inc Waste	41.2014†	30.00	36.00

†While stocks last.



Biava Mini Range

BIAVA MINI

HP1

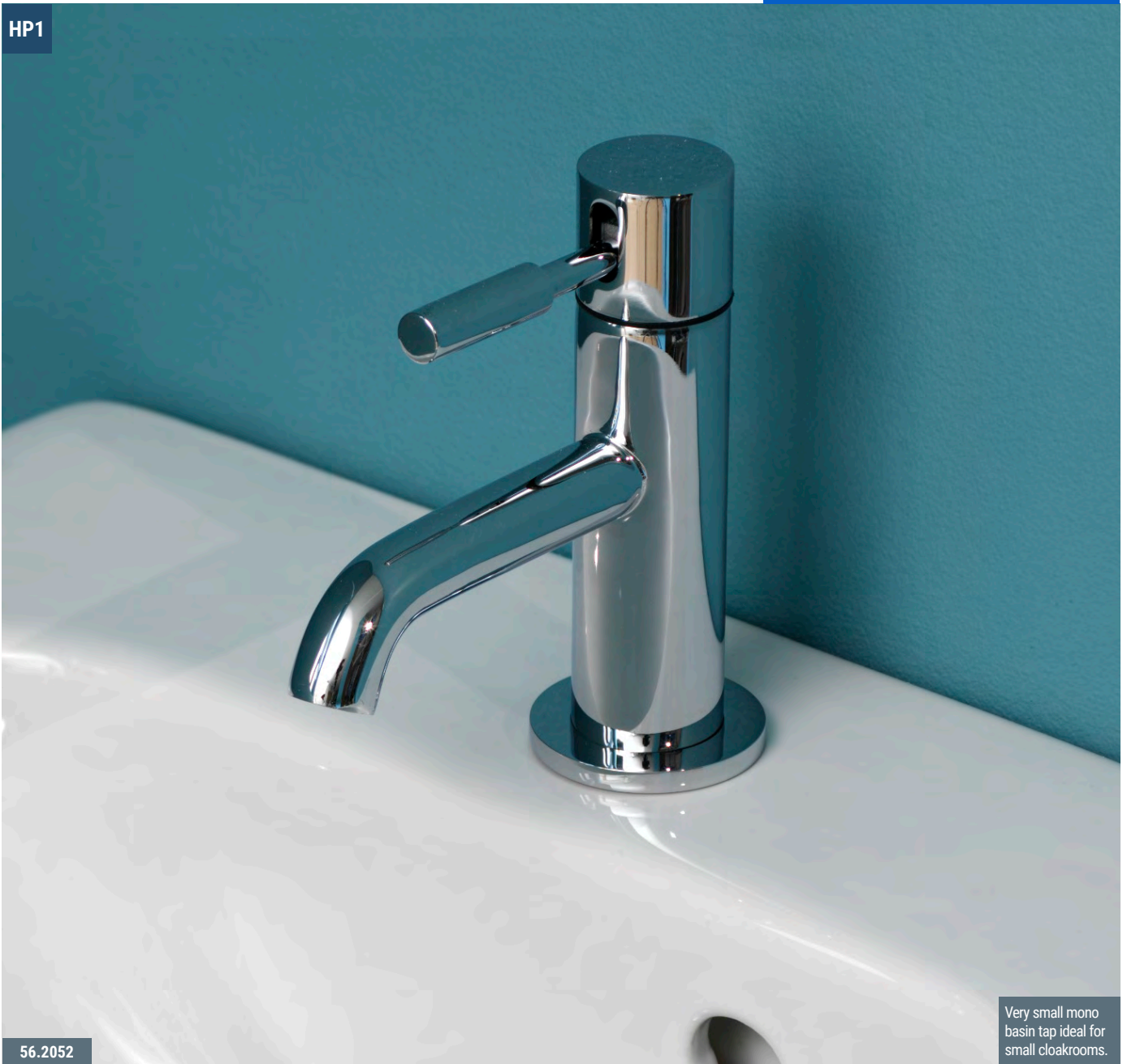

Very small mono basin tap ideal for small cloakrooms.

56.2052

Biava Mini			
Description	Code	£ Ex VAT	£ Inc VAT
Biava Mini basin mono c/w clicker waste	56.2052	83.00	99.60

Note: Minimum recommended pressure 1.0. Ceramic disc technology.

HP1



56.2052

Required minimum operating pressure key

- MP** - 0.5 bar minimum
- HP1** - 1 bar minimum

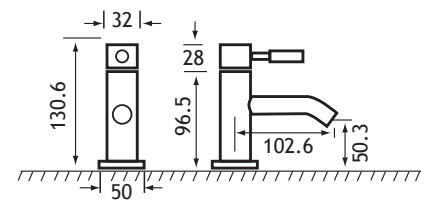

56.2052

Helston Range

HELSTON



Pressure (bar)	(litres/min)	(litres/min)	(litres/min)
	Basin Mono	Bath Filler	BSM
0.5	6.4	8	7.7
1	8.8	11	10.7
2	12.1	15.3	14.9
3	14.8	18.7	18.1

Note: Pressure based on an open ended valve outlet without downstream resistance.

Ceramic disc technology on all products within range.

The Helston Tap range brings a modern and premium design to any bathroom. Available in three function styles, six colours options and three quality finishes, this collection has been tailored to coordinate your style choices.

Choose your Helston tap finish!

Match your Helston Basin Mono Tap to your other bathroom products by choosing you preferred colour in one of three finishes:

GLOSS

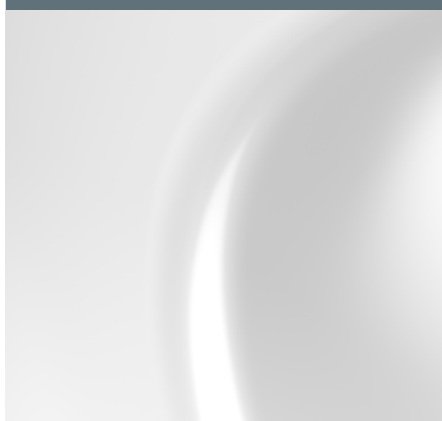

MATT SMOOTH

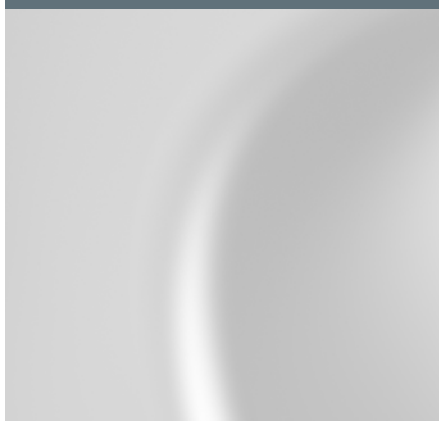

MATT TEXTURED

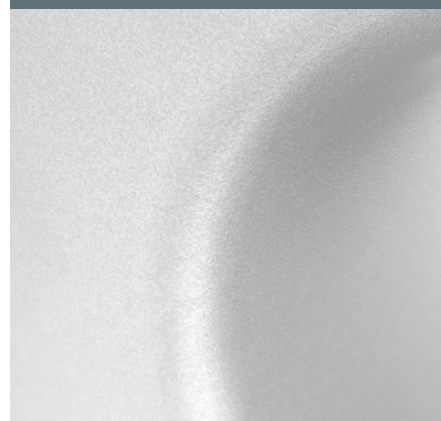

Helston Basin Mono (White)

Description	Code	£ Ex VAT	£ Inc VAT
Helston Basin Mono Gloss White (inc waste)	93.0013	87.00	104.40
Helston Basin Mono Matt Smooth White (inc waste)	93.0072	87.00	104.40
Helston Basin Mono Matt Textured White (inc waste)	93.0073	87.00	104.40

Helston Bath Filler (White)

Description	Code	£ Ex VAT	£ Inc VAT
Helston Bath Filler Gloss White	93.0014	138.00	165.60

MP



Helston BSM Inc Kit (White)

Description	Code	£ Ex VAT	£ Inc VAT
Helston BSM inc kit Gloss White	93.0015	174.00	208.80

MP



Shower Kit parts in Chrome only

MP



Helston Range

Helston Basin Mono (Chrome)			
Description	Code	£ Ex VAT	£ Inc VAT
Helston Basin Mono Chrome (inc waste)	93.0010	80.00	96.00



Helston Bath Filler (Chrome)			
Description	Code	£ Ex VAT	£ Inc VAT
Helston Bath Filler Chrome	93.0011	124.00	148.80



Helston BSM Inc Kit (Chrome)			
Description	Code	£ Ex VAT	£ Inc VAT
Helston BSM inc kit Chrome	93.0012	154.00	184.80



Helston Basin Mono (Anthracite)			
Description	Code	£ Ex VAT	£ Inc VAT
Helston Basin Mono Matt Smooth Anthracite (inc waste)	93.0016	87.00	104.40
Helston Basin Mono Gloss Anthracite (inc waste)	93.0074	87.00	104.40
Helston Basin Mono Matt Textured Anthracite (inc waste)	93.0075	87.00	104.40



Helston Bath Filler (Anthracite)			
Description	Code	£ Ex VAT	£ Inc VAT
Helston Bath Filler Matt Smooth Anthracite	93.0017	138.00	165.60



Helston BSM Inc Kit (Anthracite)			
Description	Code	£ Ex VAT	£ Inc VAT
Helston BSM inc kit Matt Smooth Anthracite	93.0018	174.00	208.80
Helston BSM inc kit Gloss Anthracite	93.0109	174.00	208.80

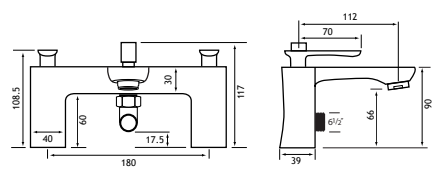
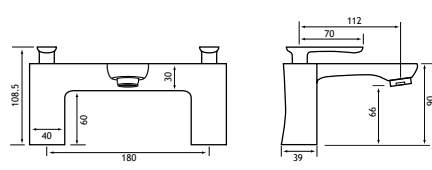
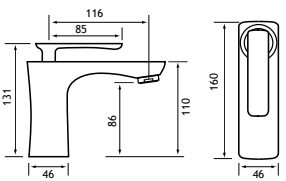

Complete the LOOK Matt Anthracite



Helston Range

HELSTON



Pressure (bar)	(litres/min)	(litres/min)	(litres/min)
	Basin Mono	Bath Filler	BSM
0.5	6.4	8	7.7
1	8.8	11	10.7
2	12.1	15.3	14.9
3	14.8	18.7	18.1

Note: Pressure based on an open ended valve outlet without downstream resistance.

Ceramic disc technology on all products within range.

Helston Basin Mono (Cappuccino)

Description	Code	£ Ex VAT	£ Inc VAT
Helston Basin Mono Gloss Cappuccino (inc waste)	93.0083	96.00	115.20
Helston Basin Mono Matt Smooth Cappuccino (inc waste)	93.0084	96.00	115.20
Helston Basin Mono Matt Textured Cappuccino (inc waste)	93.0085	96.00	115.20

MP



Matt Smooth 93.0084

Helston BSM Inc Kit (Cappuccino)

Description	Code	£ Ex VAT	£ Inc VAT
Helston BSM (inc kit) Gloss Cappuccino	93.0111	174.00	208.80

MP



Gloss 93.0111

Helston Basin Mono (Grey)

Description	Code	£ Ex VAT	£ Inc VAT
Helston Basin Mono Gloss Grey (inc waste)	93.0080	87.00	104.40
Helston Basin Mono Matt Smooth Grey (inc waste)	93.0081	87.00	104.40
Helston Basin Mono Matt Textured Grey (inc waste)	93.0082	87.00	104.40

MP



Matt Smooth 93.0081

Helston BSM Inc Kit (Grey)

Description	Code	£ Ex VAT	£ Inc VAT
Helston BSM (inc kit) Gloss Grey	93.0110	174.00	208.80

MP



Gloss 93.0110

Helston Range

Choose your Helston tap finish!

Match your Helston Basin Mono Tap to your other bathroom products by choosing your preferred colour in one of three finishes:



GLOSS

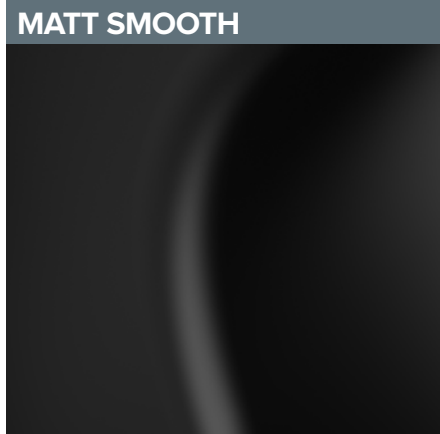

MATT SMOOTH

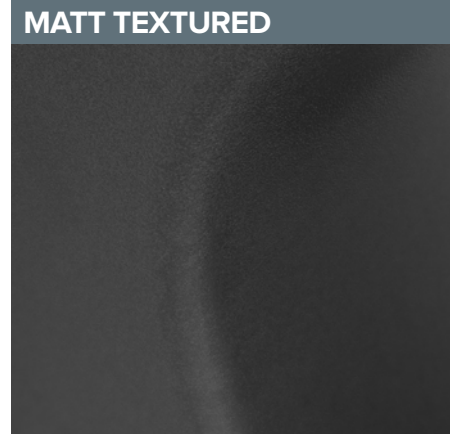

MATT TEXTURED

Helston Basin Mono (Black)			
Description	Code	£ Ex VAT	£ Inc VAT
Helston Basin Mono Matt Smooth Black (inc waste)	93.0019	87.00	104.40
Helston Basin Mono Matt Textured Black (inc waste)	93.0076	87.00	104.40
Helston Basin Mono Gloss Black (inc waste)	93.0079*	87.00	104.40

Helston Bath Filler (Black)			
Description	Code	£ Ex VAT	£ Inc VAT
Helston Bath Filler Matt Smooth Black	93.0020	138.00	165.60
Helston Bath Filler Matt Textured Black	93.0077	138.00	165.60

Helston BSM Inc Kit (Black)			
Description	Code	£ Ex VAT	£ Inc VAT
Helston BSM inc kit Matt Smooth Black	93.0021	174.00	208.80
Helston BSM inc kit Matt Textured Black	93.0078	174.00	208.80
Helston BSM inc kit Gloss Black	93.0108	174.00	208.80



MP

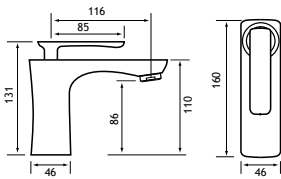

MP

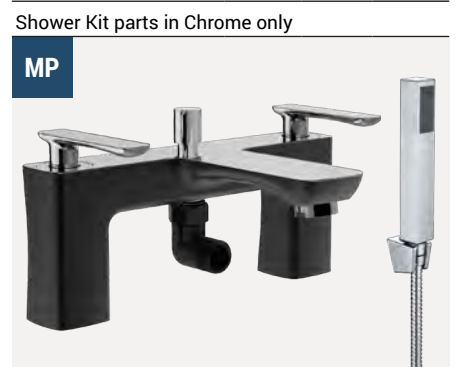
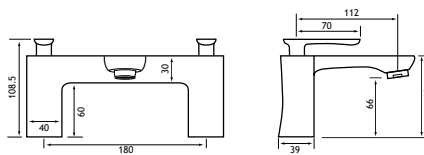

MP

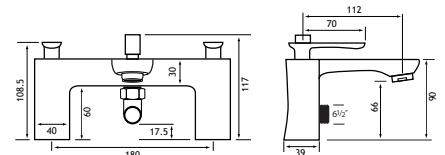

Shower Kit parts in Chrome only

Complete the LOOK Matt Smooth Black



Shower Shelf inc Shower Kit: P659

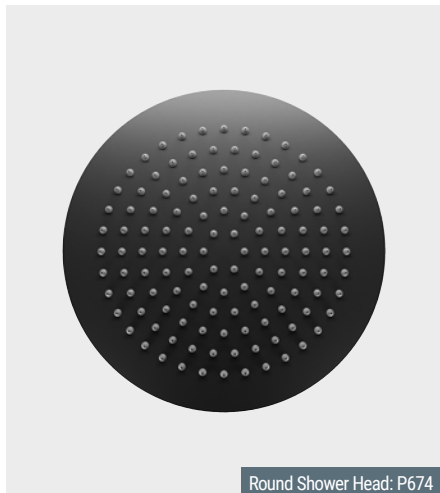

Round Shower Head: P674

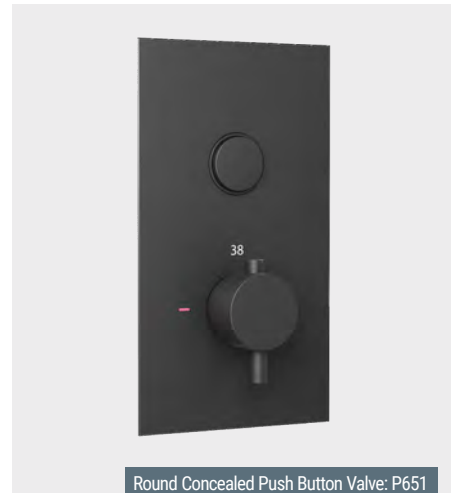

Round Concealed Push Button Valve: P651

Tec & Hayle Range

TEC

Tec Single Lever

Description	Code	£ Ex VAT	£ Inc VAT
Floor Standing Manual Mono BSM	93.0112	288.00	345.60
Floor Standing Thermostatic Mono BSM	93.0113	342.00	410.40
Wall Mounted Basin/Bath Filler	93.0041	90.00	108.00

Ceramic disc technology.

Pressure (bar)	Flow (litres/min)			
	93.0022	93.0041	93.0112	93.0113
1	7.3	7.2	9.3	9.1
2	10.2	9.9	13.0	13.4
3	12.3	12.2	15.9	16.8

HP1



93.0041

HP1

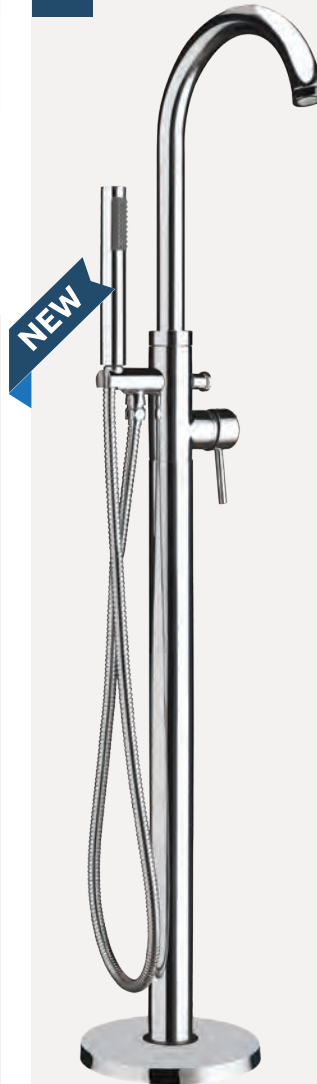

93.0112

HP1

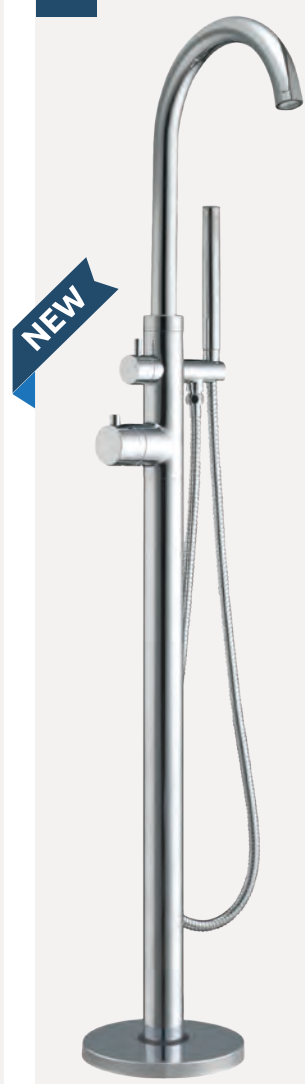

93.0113

HAYLE

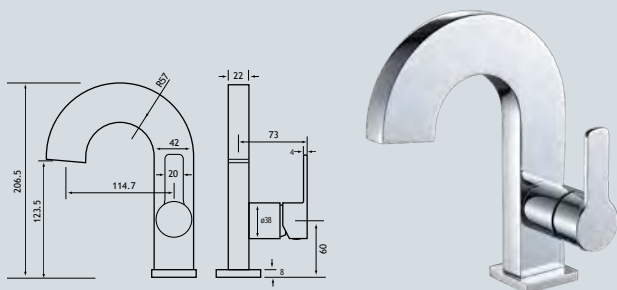

Hayle

Description	Code	£ Ex VAT	£ Inc VAT
Hayle Basin Mono Chrome	93.0022	96.00	115.20

Ceramic disc technology.

HP1

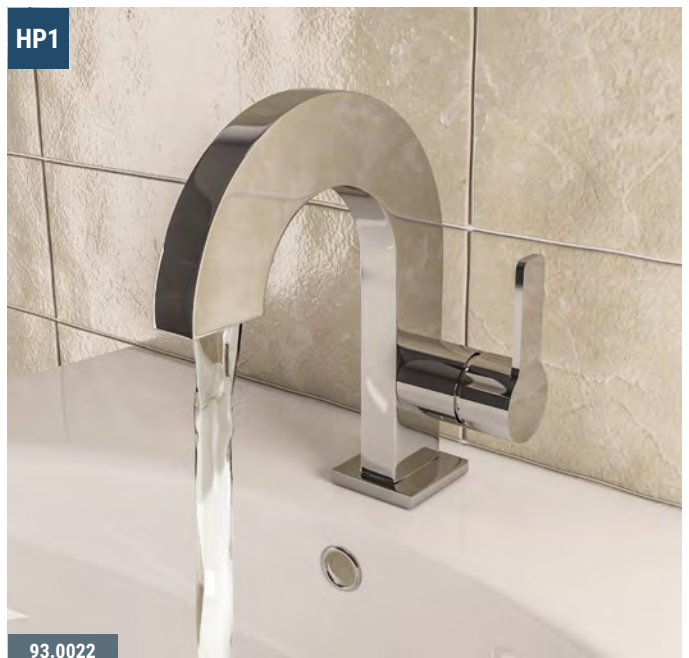

93.0022

Isbourne Range

ISBOURNE



93.0055

Isbourne			
Description	Code	£ Ex VAT	£ Inc VAT
Isbourne Basin Mono	93.0055	44.00	52.80
Isbourne Bath Filler †	41.2001	41.00	49.20
Isbourne BSM inc kit	93.0057	75.00	90.00

Ceramic Disc Technology. †While stocks last.



93.0057 (inc kit)

MP



93.0055

FEATURES

- Made from brass
- Ceramic disk technology

Required minimum operating pressure key

MP - 0.5 bar minimum

HP1 - 1 bar minimum

MP



41.2001

MP



93.0057

For Shower Kits see page 668-670

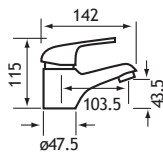

93.0055

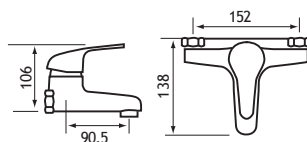

41.2001

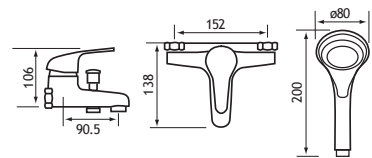

93.0057

Walton & Winchcombe Range

WALTON

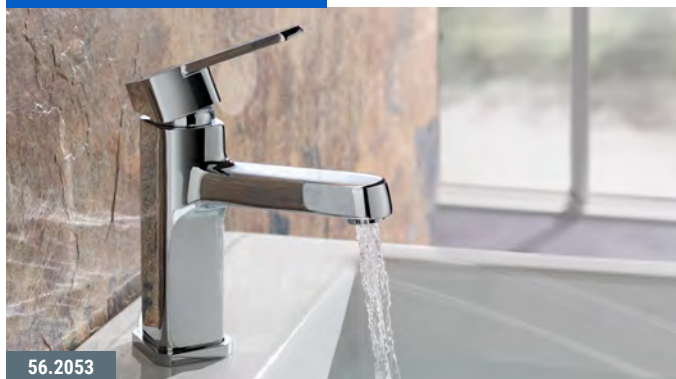

56.2053

Walton			
Description	Code	£ Ex VAT	£ Inc VAT
Walton Basin Mono	56.2053	146.00	175.20
Walton Bath Filler	56.2054	231.00	277.20
Walton BSM inc kit**	56.2055	261.00	313.20
Minimalist Square Handset*	98.0016	8.00	9.60

Ceramic disc technology. *98.0016 square hand set as optional extra. **Wall brackets sold separately.

Required minimum operating pressure key

MP - 0.5 bar minimum



56.2053



56.2054



56.2055



98.0016

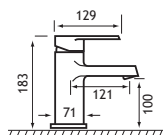

56.2053

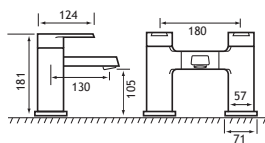

56.2054

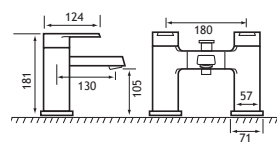

56.2055

WINCHCOMBE

Winchcombe			
Description	Code	£ Ex VAT	£ Inc VAT
Winchcombe Basin Mono	56.2056	139.00	166.80
Winchcombe Bath Filler	56.2057	189.00	226.80
Winchcombe BSM inc kit*	56.2058	219.00	262.80

Ceramic disc technology. *Wall brackets and slide rail kit sold separately.



56.2056



BSM KIT



56.2058



MP

56.2056

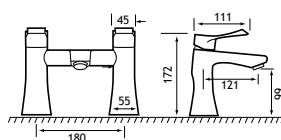

56.2057

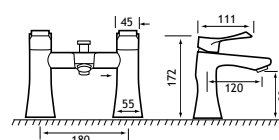

56.2058

Westbourne & Wingrave Range

WESTBOURNE

Westbourne			
Description	Code	£ Ex VAT	£ Inc VAT
Westbourne Basin Mono	56.2059	126.00	151.20
Westbourne Bath Filler	56.2060	179.00	214.80
Westbourne BSM inc kit*	56.2061	206.00	247.20

*Wall brackets sold separately. Ceramic disc technology.

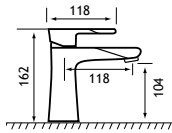

56.2059

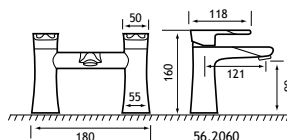

56.2060

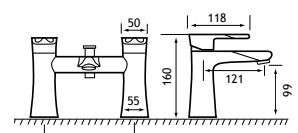

56.2061

Wingrave			
Description	Code	£ Ex VAT	£ Inc VAT
Wingrave Basin Mono	56.2062	137.00	164.40
Wingrave Bath Filler	56.2063	198.00	237.60
Wingrave BSM inc kit*	56.2064	227.00	272.40
Minimalist Square Handset**	98.0016	8.00	9.60

*Wall brackets sold separately. **98.0016 handset as optional extra. Ceramic disc technology.

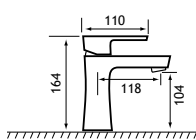

56.2062

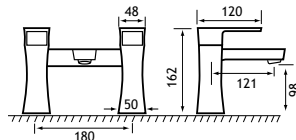

56.2063

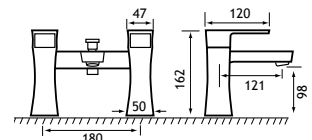

56.2064

WINGRAVE

Winchester & Cortauld Range

WINCHESTER

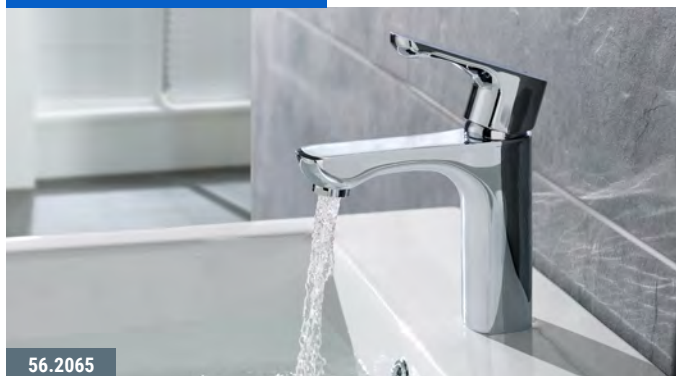

56.2065

Winchester			
Description	Code	£ Ex VAT	£ Inc VAT
Winchester Basin Mono	56.2065	130.00	156.00
Winchester Bath Filler	56.2066	191.00	229.20
Winchester BSM inc kit*	56.2067	219.00	262.80

*Wall brackets sold separately. Ceramic disc technology.



MP

56.2066



MP

56.2067



BSM KIT



MP

56.2065

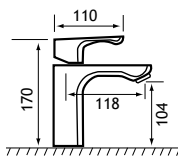

56.2065

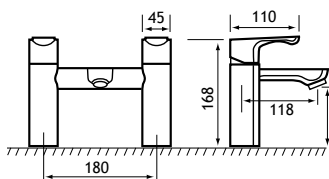

56.2066

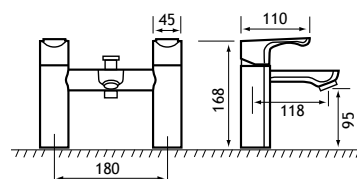

56.2067

CORTAULD



MP

56.2040

Cortauld			
Description	Code	£ Ex VAT	£ Inc VAT
Cortauld mono basin c/w clicker waste	56.2040	121.00	145.20
Cortauld mono bidet c/w clicker waste	56.2041	121.00	145.20
Cortauld high rise mono basin c/w clicker waste	56.2042	143.00	171.60
Cortauld bath filler	56.2043	183.00	219.60
Cortauld BSM inc kit*	56.2044	192.00	230.40

*Wall brackets sold separately. Ceramic disc technology.



MP

56.2043



MP

56.2044



MP

56.2041



MP

56.2042

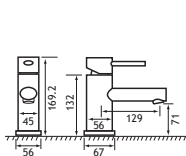

56.2040

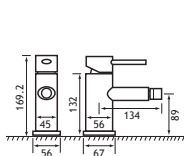

56.4041

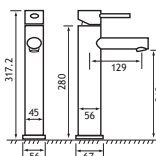

56.2042

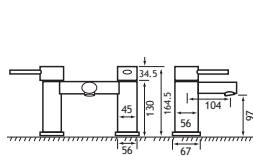

56.2043

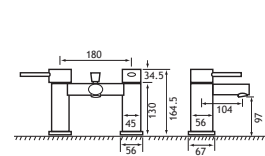

56.2044

Estorick & Albermarle Range

ESTORICK

Estorick			
Description	Code	£ Ex VAT	£ Inc VAT
Estorick mono basin c/w	56.2035	128.00	153.60
Estorick mono bidet c/w	56.2036	128.00	153.60
Estorick high rise basin mono c/w	56.2037	150.00	180.00
Estorick bath filler	56.2038	165.00	198.00
Estorick BSM inc kit*	56.2039	172.00	206.40

*Wall brackets sold separately. Ceramic disc technology.

With the high angle of discharge of this spout, customers with a high pressure supply may have to fit pressure reducing valves or partially close the isolating valves to ensure the discharge stays within smaller basins.



56.2035

Swivel spout

Pressure (bar)	Flow (litres/min)	
	Bath Filler (56.2038)	BSM (56.2039)
0.1	4.8	4.6
0.5	10.1	9
1	15.6	14
2	22.5	20.4

Required minimum operating pressure key

MP - 0.5 bar minimum



MP

56.2035



MP

56.2036



MP

56.2039



BSM KIT



MP

56.2037



MP

56.2038

ALBERMARLE



Albermarle

Description	Code	£ Ex VAT	£ Inc VAT
Albermarle bath filler	56.2051	209.00	250.80

Ceramic disc technology.

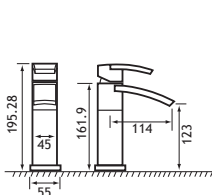

56.2035

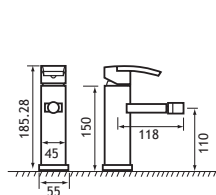

56.2036

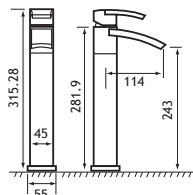

56.2037

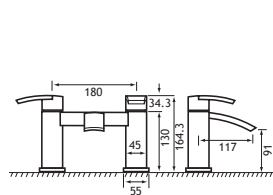

56.2038

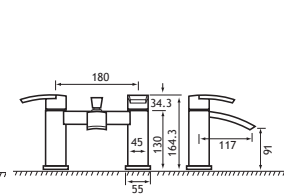

56.2039

Firth & Diorama Range

FIRTH

Firth			
Description	Code	£ Ex VAT	£ Inc VAT
Firth BSM inc kit*	56.2050	186.00	223.20
Minimalist Square Handset**	98.0016	8.00	9.60

*Wall brackets sold separately. Ceramic disc technology.

** 98.0016 handset as optional extra. *While stocks last.

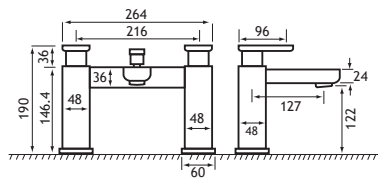

56.2050

MP



56.2050



98.0016

MP - 0.5 bar minimum

DIORAMA

Diorama			
Description	Code	£ Ex VAT	£ Inc VAT
Diorama mono basin c/w clicker waste	56.2028	115.00	138.00
Diorama bath filler	56.2030	166.00	199.20
Diorama BSM inc kit*	56.2031	191.00	229.20
Minimalist Square Handset**	98.0016	8.00	9.60

*Wall brackets sold separately. Ceramic disc technology.

** 98.0016 handset as optional extra.

MP



56.2028

MP



56.2030

MP



56.2031

BSM KIT



MP



98.0016

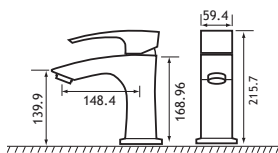

56.2028

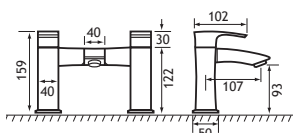

56.2030

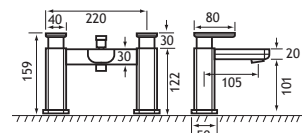

56.2031

Hooper & Vivande Range

HOOPER



56.2045

Hooper			
Description	Code	£ Ex VAT	£ Inc VAT
Hooper mono basin c/w clicker waste	56.2045	100.00	120.00
Hooper bath filler	56.2046	161.00	193.20
Hooper BSM inc kit*	56.2047	184.00	220.80

*Wall brackets sold separately. Ceramic disc technology.



MP

56.2045

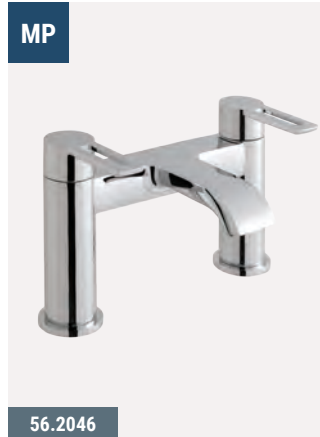

MP

56.2046

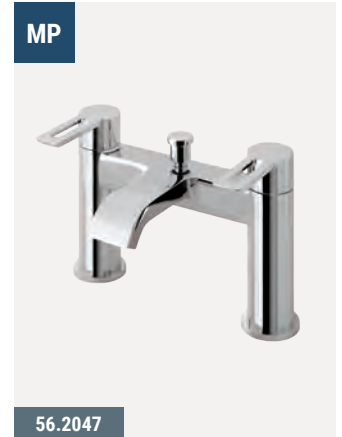

MP

56.2047

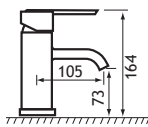

56.2045

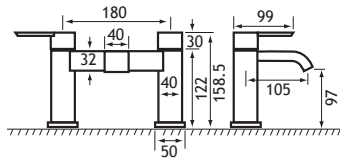

56.2046

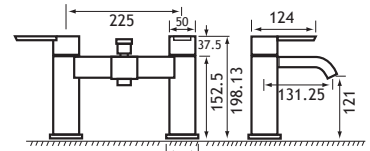

56.2047

VIVANDE

Vivande			
Description	Code	£ Ex VAT	£ Inc VAT
Vivande mono basin c/w clicker waste	56.2032	102.00	122.40
Vivande bath filler	56.2033	161.00	193.20
Vivande BSM inc kit*	56.2034	184.00	220.80

*Wall brackets sold separately. Ceramic disc technology.



BSM KIT



MP

56.2032



MP

56.2032

Minimum recommended operating pressure 0.5 bar



MP

56.2034

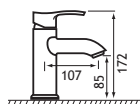

56.2032

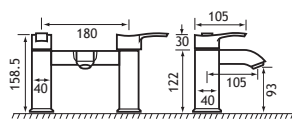

56.2033

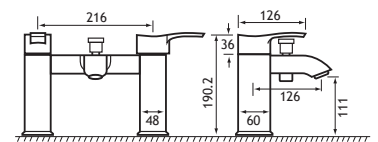

56.2034

Biava Hi Flow & Linslade Range

BIAVA HI.FLOW

Biava Hi.flow

Description	Code	£ Ex VAT	£ Inc VAT
Biava Hi.Flow Basin Mono	93.0052	71.00	85.20
Biava Hi.Flow Bath Filler	93.0053	84.00	100.80
Biava Hi.Flow Bath Filler inc Diverter	93.0054	95.00	114.00

Ceramic disc technology.

Pressure (bar)	(litres/min)		
	Basin Mono (93.0052)	Bath Filler (93.0053)	BSM (93.0054)
0.1	6.8	9.5	9.3
0.5	13.6	22.1	21.6
1	18.8	32.1	30.8
2	26.4	43.6	43.2
3	32.1	53.4	53.3

Note: Pressure based on an open ended valve outlet without downstream resistance.

Required minimum operating pressure key

LP1 - 0.1 bar minimum

MP - 0.5 bar minimum



LINSLADE

Linslade

Description	Code	£ Ex VAT	£ Inc VAT
Linslade Mono Basin	56.2070	88.00	105.60
Linslade Bath Filler	56.2082	121.00	145.20
Linslade BSM inc kit*	56.2083	153.00	183.60

*Wall brackets sold separately. Ceramic disc technology.

BSM KIT

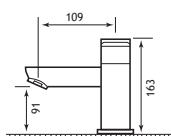

56.2070

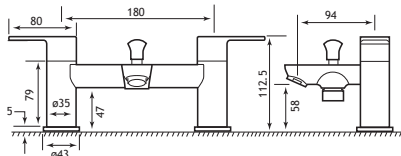

56.2083

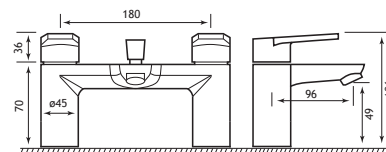

56.2082

Prestwood Range

PRESTWOOD

MP



56.2078

Prestwood			
Description	Code	£ Ex VAT	£ Inc VAT
Prestwood Mono Basin	56.2078	88.00	105.60
Prestwood Bath Filler	56.2079	157.00	188.40
Prestwood BSM inc kit*	56.2080	194.00	232.80

*Wall brackets sold separately. Ceramic disc technology.

MP



56.2079

MP



56.2080

BSM KIT



MP



56.2078

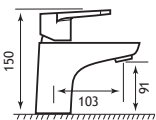

56.2078

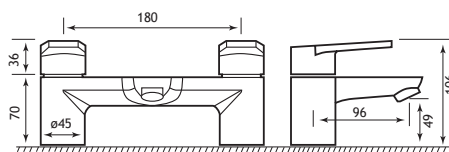

56.2079

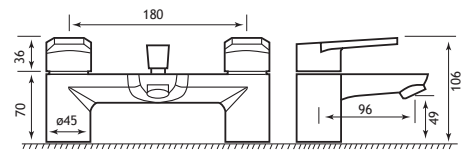

56.2080

Leith Range

LEITH

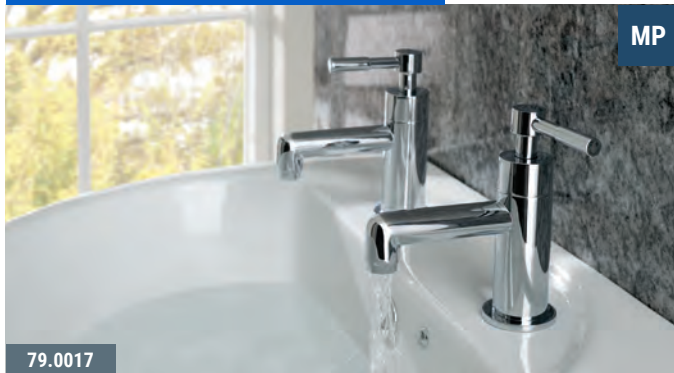

79.0017

Leith			
Description	Code	£ Ex VAT	£ Inc VAT
Leith Floor Mounted BSM inc kit	79.0015	327.00	392.40
Leith BSM inc kit	79.0016	126.00	151.20
Leith Basin Taps	79.0017	62.00	74.40
Leith Bidet Mono inc push button waste	79.0018	71.00	85.20
Leith Bath Filler	79.0019	103.00	123.60
Leith Basin Mono inc push button waste	79.0020	72.00	86.40
Leith Bath Taps	79.0021	77.00	92.40
Leith Wall Mounted Basin Mixer	79.0022	74.00	88.80
Leith Wall Mounted Bath Filler	79.0023	75.00	90.00

Ceramic disc technology.



79.0015

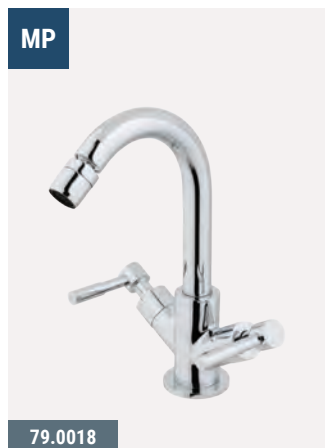

79.0018

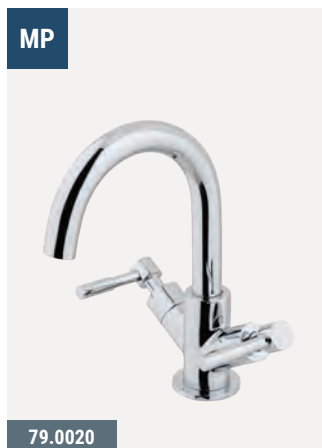

79.0020

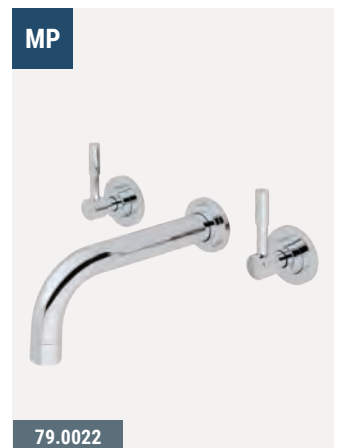

79.0022



79.0016



79.0019



79.0021



79.0023

Pressure (bar)	Flow (litres/min)
0.1	9
0.5	18
1	29
2	43
3	51

Note: Pressure based on an open ended valve outlet without downstream resistance. Applies to bath filler only.

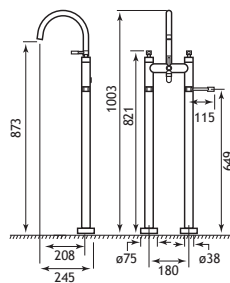

79.0015

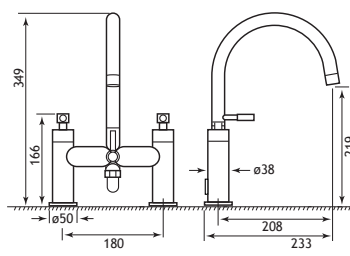

79.0016

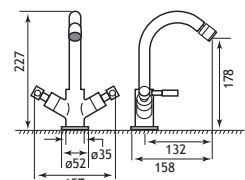

79.0018

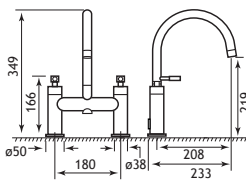

79.0019

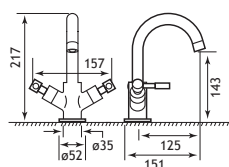

79.0020

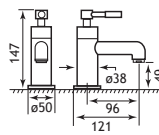

79.0021

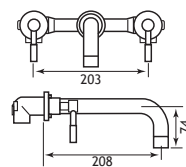

79.0022

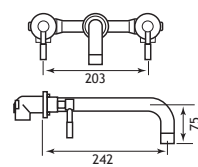

79.0023

Newlyn Range & Thermostatic BSM



Ceramic disc technology on all products within range.

NEWLYN

Pressure (bar)	Flow (litres/min)	
	Bath Filler (93.0008)	BSM (93.0009)
0.5	7.1	7.0
1	9.9	9.7
2	13.7	13.5
3	16.7	16.5

Note: Pressure based on an open ended valve outlet without downstream resistance.

The Newlyn range is a traditional collection that brings an elegant touch to any bathroom.

Newlyn Basin Mono			
Description	Code	£ Ex VAT	£ Inc VAT
Newlyn Basin Mono (inc waste) Chrome	93.0007	104.00	124.80



Newlyn Bath Filler			
Description	Code	£ Ex VAT	£ Inc VAT
Newlyn Bath Filler Chrome	93.0008	150.00	180.00



Newlyn BSM Inc Kit			
Description	Code	£ Ex VAT	£ Inc VAT
Newlyn BSM inc kit Chrome	93.0009	171.00	205.20



THERMOSTATIC BATH SHOWER MIXERS

Thermostatic bath shower mixers that can be wall or deck mounted.

MP

93.0038 For Shower Kits see page 668-670

New Biava Wall Mounted Thermostatic BSM w/o Kit Chrome

Code	£ Ex VAT	£ Inc VAT
93.0038	111.00	133.20

Pressure LP1 (1 bar minimum)

- Fixing centres 150mm
- Chrome plated brass body
- Thermostatic control
- Ceramic disc cartridge technology
- Anti-scald function
- Built in diverter



Shower hose not included.

93.0038 Pressure (bar)	Flow (litres/min)
1	12
2	18.5
3	22.5

Note: At maintained equal inlet pressures with open outlet at mid blend temperature.

MP

93.0039 For Shower Kits see page 668-670

Cotswold Wall Mounted Thermostatic BSM w/o kit Chrome

Code	£ Ex VAT	£ Inc VAT
93.0039	94.00	112.80

Pressure LP1 (1 bar minimum)

- Fixing centres 150mm
- Chrome plated brass body
- Thermostatic control
- Ceramic disc cartridge technology
- Anti-scald function
- Built in diverter



93.0039 Pressure (bar)	Flow (litres/min)
1	13.5
2	19.8
3	23.2

Note: At maintained equal inlet pressures with open outlet at mid blend temperature.



Pictured 93.0038 with 93.0040



93.0040

Deck Mounting Pillars Chrome

Code	£ Ex VAT	£ Inc VAT
93.0040	25.00	30.00

When fitted with 93.0038 / 93.0039, please change centre fixings from 150mm to 180mm

Portobello Range

PORTOBELLO

LP1



79.0004

Portobello

Description	Code	£ Ex VAT	£ Inc VAT
Portobello BSM inc kit	79.0001	154.00	184.80
Portobello Basin Mono inc click waste	79.0002	66.00	79.20
Portobello Bidet Mono inc pop up waste	79.0003	68.00	81.60
Portobello Basin Taps	79.0004	57.00	68.40
Portobello Bath Filler	79.0005	101.00	121.20
Portobello Bath Taps	79.0006	78.00	93.60

Ceramic disc technology.

Required minimum operating pressure key

LP1 - 0.1 bar minimum

LP1



79.0001

LP1



79.0002

LP1



79.0003

LP1



79.0005

LP1



79.0006

Haymarket Range

HAYMARKET



LP1

79.0007

Haymarket			
Description	Code	£ Ex VAT	£ Inc VAT
Haymarket Standard Basin Taps	79.0007	45.00	54.00
Haymarket Luxury Basin Taps	79.0008	52.00	62.40
Haymarket Bath Taps	79.0009	54.00	64.80
Haymarket Basin Mono inc click waste	79.0010	58.00	69.60
Haymarket Bidet Mono inc pop up waste	79.0011	63.00	75.60
Haymarket Luxury BSM inc Kit	79.0012	158.00	189.60
Haymarket Standard BSM inc kit	79.0013	109.00	130.80
Haymarket Bath Filler	79.0014	104.00	124.80

Required minimum operating pressure key

LP1 - 0.1 bar minimum



LP1

79.0008



LP1

79.0009



LP1

79.0010



LP1

79.0011



LP1

79.0012



LP1

79.0013



LP1

79.0014

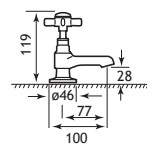

79.0007

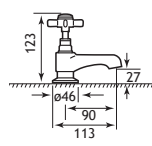

79.0008

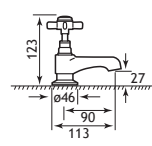

79.0009

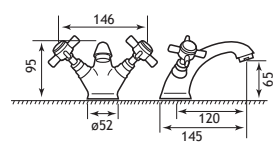

79.0010

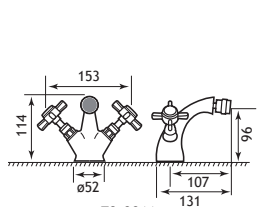

79.0011

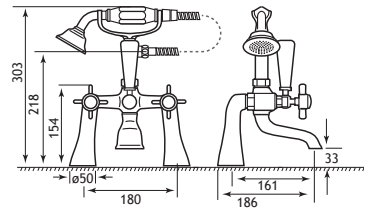

79.0012

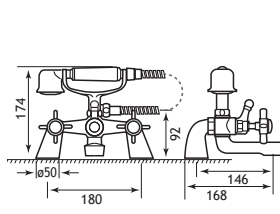

79.0013

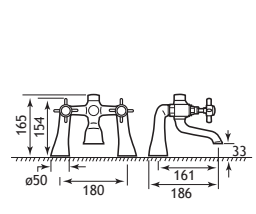

79.0014

Stenhouse Range

STENHOUSE



LP1

79.0024

Stenhouse			
Description	Code	£ Ex VAT	£ Inc VAT
Stenhouse Basin Taps	79.0024	36.00	43.20
Stenhouse Standard BSM inc kit	79.0025	88.00	105.60
Stenhouse Basin Mono inc click waste	79.0026	55.00	66.00
Stenhouse Bath Taps	79.0027	41.00	49.20
Stenhouse Bath Filler	79.0028	65.00	78.00
Stenhouse Luxury BSM inc kit	79.0029	104.00	124.80

Ceramic disc technology. 1/4 turn.

LP1



79.0027

LP1



79.0025

LP1



79.0026

LP1



79.0028

LP1



79.0029

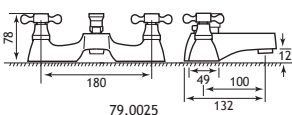

79.0025

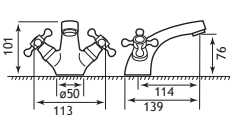

79.0026

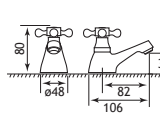

79.0027

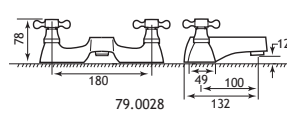

79.0028

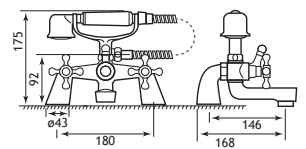

79.0029

Kenton Range & Kitchen Taps

KENTON

Kenton			
Description (Chrome)	Code	£ Ex VAT	£ Inc VAT
Kenton Basin Taps†	41.2003	23.00	27.60
Kenton Bath Taps†	41.2004	24.00	28.80

Ceramic disc technology. †While stocks last.

FEATURES

- WRAS Certificate
- Made from brass - sterilisation and anti-rust



41.2003



41.2004



41.2003



41.2004

Kitchen Taps & Wastes

Description	Code	£ Ex VAT	£ Inc VAT
Contract Sink Waste†	4.5213	8.00	9.60
Mono Sink Mixer Chrome	93.0023	29.00	34.80
Mono Sink Mixer with pull out rinser	93.0024	54.00	64.80

†While stocks last.

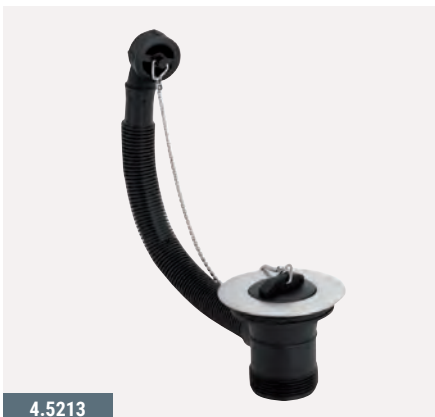

4.5213

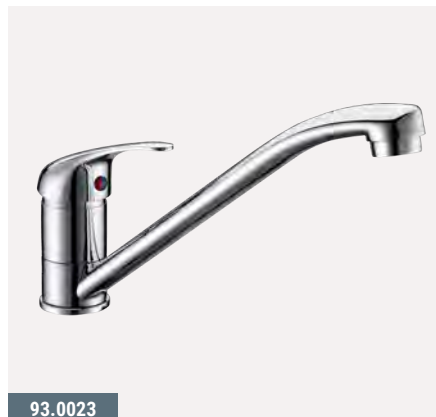

93.0023

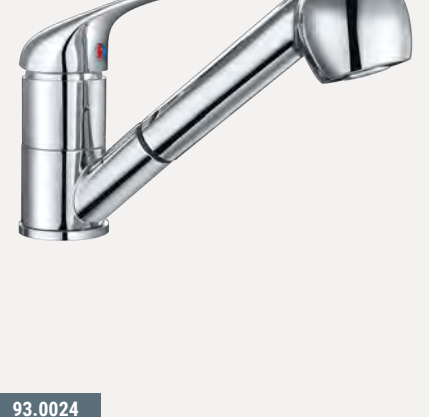

93.0024

KITCHEN TAPS

Wastes, Levers & Accessories

BATH WASTES

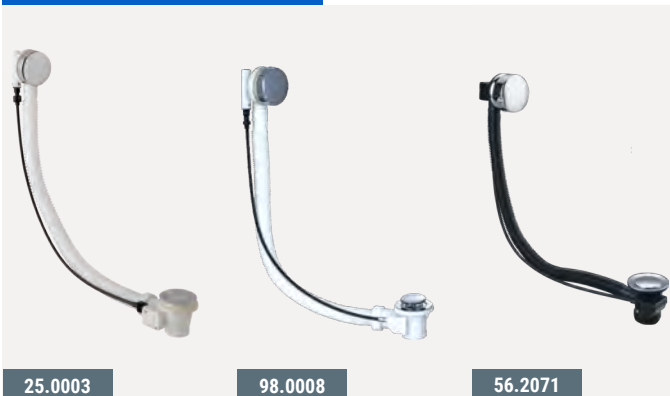

Bath Wastes			
Description	Code	£ Ex VAT	£ Inc VAT
Exposed Bath Pop Up Waste	25.0001	112.00	134.40
Luxury Bath Pop Up Waste & Overflow	25.0003	30.00	36.00
Luxury Bath Pop Up Waste & Overflow	41.2008	32.00	38.40
Bath Pop Up Waste & Overflow	56.2071	25.00	30.00
Superior Bath Pop Up Waste & Overflow	56.2072	28.00	33.60
Bath Combined Waste & Overflow	41.2009	13.00	15.60
Push Button Bath Waste & Overflow	7.0011	57.00	68.40
Ceramic Top Bath Waste	45.0001	39.00	46.80
Flipper Bath Waste	25.0007	27.00	32.40
Square Sprung Plug Bath Waste	98.0006	31.00	37.20
Extended Bath Pop-up Waste & Overflow	98.0008	27.00	32.40



BOTTLE TRAPS

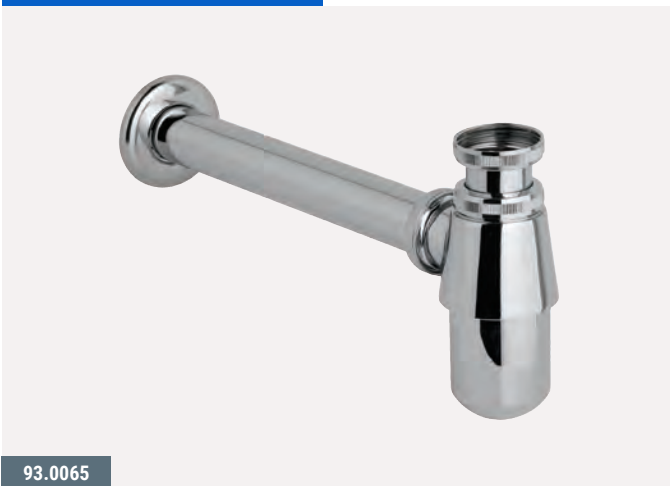

Bottle Traps			
Description	Code	£ Ex VAT	£ Inc VAT
1.25" Bottle Trap inc Extender Tube	98.0017	30.00	36.00
Square Bottle Trap and Extension Tube Chrome	93.0050	48.00	57.60
Minimalist Bottle Trap	93.0065	26.00	31.20



LEVERS

Levers			
Description	Code	£ Ex VAT	£ Inc VAT
Metal Universal WC Lever	98.0011	7.00	8.40
Ceramic Handle WC Lever	98.0012	10.00	12.00



Wastes, Levers & Accessories

BASIN WASTES

Basin Wastes			
Description	Code	£ Ex VAT	£ Inc VAT
Push Button Basin Waste	25.0002	15.00	18.00
Basin Waste, Ball Chain, Solid Plug	98.0007	11.00	13.20
Sprung Plug Basin Waste Unslotted	98.0002	14.00	16.80
Push Button Basin Waste	56.2073	19.00	22.80
Flip Top Basin Waste - Slotted	25.0006	12.00	14.40
Flip Top Basin Waste - Unslotted	25.0005	12.00	14.40
Basin Waste Link Chain Brass Plug	98.0003	12.00	14.40
Push Button Basin Waste	41.2010	25.00	30.00
Ceramic Top Basin Waste	45.0000	17.00	20.40

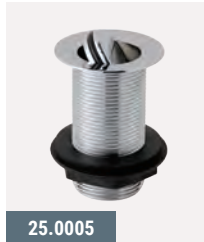
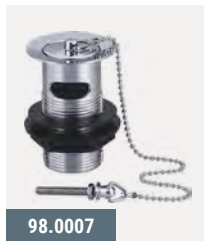

FRAMES

Frames			
Description	Code	£ Ex VAT	£ Inc VAT
Wall Hung Pan/Bidet Brackets	21.149B	140.00	168.00
Mirage Frame 310 x 345	73.0003	115.00	138.00
L-Shape Wall Hung Pan/Bidet Brackets	90.0010	56.00	67.20



Roll Top & Freestanding Bath Accessories

Roll Top & Freestanding Bath Accessories

Description	Code	£ Ex VAT	£ Inc VAT
Waste and Overflow	82.0006	61.00	73.20
Shallow Seal Trap	98.0010	63.00	75.60
Bath Legs with adjustable shrouds	98.0013	70.00	84.00
Standpipes 26" x 40mm	98.0020	81.00	97.20
Roll Top Bath Waste Pack	98.0004	189.00	226.80
Exposed Bath Pop Up Waste	98.0005	96.00	115.20



82.0006



98.0005



98.0010



98.0004



98.0020



98.0013

MISCELLANEOUS

Roll Top & Freestanding Bath Accessories

Description	Code	£ Ex VAT	£ Inc VAT
Volente Luxury Shower Waste Chrome	41.5000	17.00	20.40
Pressure Reducing Valve 15mm x 15mm	41.3000	44.00	52.80
90mm Shower Waste	12.040	14.00	16.80
Fischer Bolts Set - Basin to Wall	9.201	11.00	13.20
Fischer Bolts Set - Pan to Floor - Top Fixing	9.202	7.00	8.40
Fischer cloakroom/corner basin brackets	9.203	12.00	14.40
Fischer Bolts Set	9.204	16.00	19.20
Top Access Easy Clean Shower Waste	25.0004	11.00	13.20
Deck Shower Kit*	98.0001	55.00	66.00

*Available November 2019



41.3000

41.3000 Pressure reducing valve is suitable for water temperature up to 80°C and inlet pressures up to 16 bar. The outlet pressure can be adjusted between 1 bar and 6 bar. Typically these valves are used on the incoming water supply.



41.5000



12.040



98.0001

NEW

What our customers think

“I just wanted to say a big thank you to the whole team there for all the help that you have given me sorting out a problem faced by one of my customers.”

Andy

“I must say, I am hugely impressed by your outstanding customer service. Consider me an eastbrook customer for life!! Brilliant!!”

Lloyd

“Hi everybody, received handle all OK, thank you so much for your kind help, would recommend your company service. Excellent.”

Harry

“Thank you, great to work with such a great company! Not many of you about!”

Lisa

“Hiya - we just wanted to tell you how lovely and helpful your driver is!! What a star.

Vicky

“Many thanks. Most help I’ve received from any company. It will be an Eastbrook product I buy now.”

Christine

“Breathtakingly good customer service.”

Elaine

“After exhausting every avenue trying to find a basin waste, Eastbrook came through like a gleaming light. You are always so very helpful and cheerful on the phone, it would be great if there was at least one of you with every supplier.”

David

Index

A

Acer Bath Panels	141
Addington Type10 Radiator	552–553
<i>Flat Towel Hangers</i>	554
Addington Type10 Towel Rails	555
Addington Type20 Radiator	556–557
Addington Type20 Towel Rail	560
Addington Type21 Radiator Horizontal	558
<i>Type21 Towel Rail</i>	561
Addington Type22 Radiator Horizontal	559
Advantage Deep Bath	47
Albano Range	252–255
Albany Bath	60
<i>1700</i>	60
Albermarle Taps	703
Alento - Ceramic Shelf	296
Alento Range	256–259
Alento Range Accessories	300
Alpha Bath	74
<i>1700</i>	74
<i>1800</i>	89
Ampney Radiator	619
Andelle Sanitaryware Range	174
Anjou Sanitaryware Range	175
Apex Bath	80
<i>1700</i>	80
Arc Bath Duo	74
<i>1700</i>	74
<i>1800</i>	90
<i>1700 Showerbath</i>	118–119
<i>1500 Single Ended</i>	48
<i>1700 Single Ended</i>	61, 75
Arkitekt Sanitaryware Range	176
Ascona Radiator	613
Avon Radiator	621
Axis Bath	48
<i>1500</i>	48
<i>1600</i>	52
<i>1700</i>	61
<i>1700 Showerbath</i>	114–115

B

Back to Wall Pans (Sanitaryware)	242–243
Bali Bath Corner	131
<i>1200</i>	131
Bar Valves	658
Basin Wastes	715
Bath & Basin Wastes (Accessories)	310
Bath Fillers	680, 681
Bath Panels	141
<i>Acer</i>	141
<i>Bonito</i>	141
<i>Carronite Concord</i>	137
<i>Carronite Front Panels</i>	137
<i>Concord</i>	136
<i>Diamante</i>	141
<i>L-Shaped Carronite</i>	137
<i>Quantum</i>	136
<i>Sherwood</i>	138–139
<i>Sherwood Classic</i>	140
<i>Sherwood Ultra</i>	140
<i>Wave</i>	138
Bath Panels (Vanity)	384, 385, 386
Bath Screens	144
<i>Bathguard 300 x 1400mm</i>	144

Bathscreen 250mm Fixed 750mm Hinged	143
Corniche Bath Screen With Rail	144
Radius Corner Bath Screen	144
Sail Shape Screen With Towel Rail	144
Volente Folding	145
Volente Hinged Screens	146–147
Volente Overbath Slider	143
Bath Wastes	714
Belgravia Sanitaryware Range	177
Berlini Radiator	586–587
<i>Vertical</i>	586–587
Bespoke Colours (Radiators)	638
Bespoke Sizes (Radiators)	639
Biarritz Britannia Bath	91
<i>1800</i>	91
Biava	533
<i>Corinium Radiator</i>	533
<i>Dry Element Radiator Straight</i>	516–517
<i>Flat Radiator</i>	614
<i>Hi Flow Taps</i>	706
<i>High Output Radiator Straight Chrome</i>	518
<i>Biava Mini Taps</i>	693
Biava Multirail Radiator	515
<i>Curved Chrome</i>	515
<i>Curved White</i>	514
<i>Straight Chrome</i>	513
<i>Straight White</i>	512
Biava Radiator Double Tube On Tube	523
<i>Round</i>	519
<i>Square</i>	524
<i>Tube on Tube</i>	522
Biava Wet Floor System	470–471
Bijou Sanitaryware Range	178–179
Body Jets (Showering)	677
Bonito 120 Cabinet Mirror	397
Bonito 120 Vanity Units	314–315
Bonito Bath Panels	141
Bonito Corner Unit	402
Bonito Corner Vanity Units	320
Bonito Slab Vanity Units	316–319
Bosini Mirror	393
Bottle Traps	714
Bottle Traps (Accessories)	311
Bowmont LED Mirror	405
Brio Bath	103
<i>1650 (5'5") Showerbath</i>	103
Britannia Bath	75
<i>1700 Classic Super Deep</i>	75
<i>1700 Victoria</i>	62
Brunswick Mirror	390
Burford Radiator	606–607
<i>Horizontal</i>	606–607
<i>Vertical</i>	604–605

C

Cabinet Mirror	393
Cabinet Mirror With Cornices	395, 396
Caldini Cabinet Mirrors	394
Camborne Taps	691
Camden Bath	56
<i>1600</i>	56
<i>1650</i>	58
<i>1700</i>	61
Carronite Concord Bath Panels	137
Carronite Front Bath Panels	137
Castilla Drawer Vanity Unit	321
Ceiling Mounted Shower Arms	672
Ceiling Mounted Waterfall Showers	671

Celsius Bath	126
<i>1900 Freestanding</i>	126
Celsius Baths	149–159
<i>1700mm C-Lenda Showerbath</i>	158
<i>1700mm Showerbath</i>	152
<i>1700mm Straight Bath</i>	150
<i>1800mm C-Lenda Showerbath</i>	159
<i>1800mm Straight Bath</i>	151
<i>Duo Luxury Bath</i>	153
<i>Freestanding</i>	155
<i>Oval</i>	154
Centennial Bath	133
<i>1500 Corner</i>	133
Charleston Florescent Mirror	413
Charlton Radiator	588
<i>Towel Hangers & Shelves</i>	589–590
Cheltenham Sanitaryware Range	182
Cheverney Sanitaryware Range	180–181
Classic Showerbath	75
Claxton Radiator	562
C-Lenda Hydrotherapy Baths	170
<i>Albany</i>	170
<i>Alpha</i>	170
<i>Britannia Classic Super Deep</i>	168
<i>Delta</i>	170
<i>Delta Showerbath</i>	171
<i>Equation</i>	168
<i>Imperial</i>	168
<i>Monarch</i>	171
<i>Quantum Duo</i>	169
<i>Quantum SE</i>	169
<i>Sigma</i>	170
<i>Status</i>	169
<i>Whirlpool Compatibility Chart</i>	164–165
Clipper Bath	128
<i>1575 Offset</i>	128
Cloakroom Basins (Sanitaryware)	237, 238, 239
Collindale Sanitaryware Range	184–185
Coln Radiator	627
Colorado Sanitaryware Range	183
Conca Range	260–261
Concealed 3/4 Push Button Shower Valves	650–651
<i>3/4 Triple Outlet</i>	648
<i>Thermostatic Shower Valves</i>	648
Concealed Cisterns (Sanitaryware)	246
Concealed Horizontal Thermostatic Shower Valve	652
Concealed Traditional Thermostatic 3/4 Shower Valves	649
Concord Bath Panels	136
Conway Shower Panel	665
Corniche Bath Screen With Rail	144
Corniche Shower Enclosures	447
<i>Hinge Door</i>	447
<i>Offset Quadrant</i>	449
<i>Quadrant</i>	448
<i>Slider Door</i>	446
Corniche Walk-In Shower Enclosure	464
Cortauld Taps	702
Courchevel Sanitaryware Range	186
Crowthorne Sanitaryware Range	188–189

D

Davos Range Accessories	300
Delta Bath	46
<i>1400</i>	46
<i>1500</i>	48
<i>1600</i>	53
<i>1650 (5'5")</i>	58

<i>1675 (5'6")</i>	59
<i>1700</i>	62
<i>1600 Showerbath</i>	104
<i>1700 Showerbath</i>	116–117
Shower Screens	105
Diamante 110 Cabinet Mirror	397
Diamante 110 Vanity Unit	322
Diamante Bath Panels	141
Diamante Corner Vanity Unit	323
Diamante High Gloss Toilet Seat	142
Diamante WC Unit	323
Diorama Taps	704
Doc M Pack Sanitaryware	190–191
Dove Bath	129
<i>1550 Offset</i>	129
D-Shape Vent Caps (Radiators)	637
Dura Sanitaryware Range	192–193

E

Echelon Bath	73
<i>1700</i>	73
<i>1800</i>	90
<i>1800 - With Tap Ledge</i>	90
Elements (Radiators)	628–629
Ellera LED Mirror	406
Elysée Sanitaryware Range	194
Enza Range	262–265
Equation Bath	70
<i>1700</i>	70
<i>1800</i>	86
Equity Bath	76
<i>1700</i>	76
<i>1800</i>	91
<i>Vertical Thermostatic Shower Valve</i>	656
Eshton Towel Rail	542–543
Esk LED Mirror	406
Estorick Taps	703
Ettrick LED Mirror	407

F

Fabriano LED Mirror	407
Fairford Radiator	602–603
<i>Horizontal</i>	602–603
<i>Vertical</i>	600–601
Falmouth Taps	692
Faro LED Mirrors	405
Faro Vanity Units	324
<i>Faro 39</i>	324
<i>Faro 58</i>	325
<i>Faro 80</i>	326
<i>Faro 100</i>	327
Farringdon Sanitaryware Range	196–197
Findhorn LED Mirror	408
Fino Range	266–273
Firth Taps	704
Flexible Shower Hoses	670
Flush Plates (Sanitaryware)	247
Frames & Brackets (WC)	715
Frames & Fixings (Accessories)	311
Freestanding Bath Accessories	716
Frome Radiator	619

G

Geneva Cabinet Mirror	398
Genoa Range Accessories	304–305
Guardia Radiator	580–581
<i>Horizontal</i>	580–581
<i>Vertical</i>	578–579

H					
Haiku Bath					
<i>1700</i>					81
<i>1800</i>					94
Halcyon Bath					
<i>1745 D</i>					84
<i>1750 Round Freestanding</i>					122
<i>1750 Round</i>					85
<i>1750 Square Free Standing</i>					123
Halku Bath					
<i>1800</i>					91
Hayle Taps					698
Haymarket Taps					711
Helston Taps					694-697
Hidden Cisterns (Sanitaryware)					247
Highgate Bath					
<i>1700</i>					72
<i>1800</i>					88
<i>1700 Duo</i>					72
<i>1800 Duo</i>					88
<i>1750 Freestanding</i>					124
<i>1700 Showerbath</i>					109
Hooper Taps					705
Hurley Towel Rail					526-527
Hydropanel Shower Panelling					484-485
Hydrotherapy					161-171
I					
Ibis Bath					
<i>1700</i>					63
Imperial Bath					
<i>1400</i>					47
<i>1500</i>					49
<i>1600</i>					53
<i>1675 (5'6")</i>					60
<i>1700</i>					63
<i>1800</i>					86
Inset Vanity Basins (Sanitaryware)					240
Isbourne Radiator					621
Isbourne Taps					699
J					
Jollytronic Electronic Eco Flush					245
K					
Kelmscott Radiator					
<i>Horizontal</i>					610-611
<i>Vertical</i>					608-609
Kenilworth Towel Rail					538-539
Kenton Taps					713
Kitchen Taps					713
Klosters LED Mirror					408
Kompact Sanitaryware Range					198-199, 200-201
L					
Langton LED Mirror					409
Leadon Radiator					626
LED Bathroom Mirror					410
LED Handsets					667
Leith Taps					708
Leonardo Radiator					525
Leven LED Mirror					409
Levers (Accessories)					311
Levers (WC)					714
Linea Bath					
<i>1900</i>					95
Linea Sanitaryware Range					202-203
Linslade Taps					706
Lisbon II Sanitaryware Range					204-207
Loire Sanitaryware Range					208, 210-211
Loxley Towel Rail					540-541
L-Shaped Carronite Bath Panels					137
Lucerne Cabinet Mirror					398
Luxury Shower Shelf					659
M					
Madrid Mirrors					403
Madrid Vanity Units					
<i>Madrid 43</i>					328
<i>Madrid 60</i>					329
<i>Madrid 80</i>					330
<i>Madrid 100</i>					331
Maestro Sanitaryware Range					212-213
Malmesbury Radiator					
<i>Horizontal</i>					596-597
<i>Towel Hangers</i>					599
<i>Vertical</i>					594-595
Manual Shower Valves					653
Manual Valves (Radiators)					630-631
Marlow Towel Rail					534-535
Matrix					
<i>1600</i>					54
Matrix Bath					
<i>1500</i>					49
<i>1700</i>					64
Mentmore Sanitaryware Range					220-221
Metro Sanitaryware Range					214-217
Mezzano Range					274-275
Mezzo Tondo Radiator					531
Minima Sanitaryware Range					218-219
Mirror Gloss Hydropanel					486
Mirrors					
<i>Cabinet Mirrors</i>					393-401
<i>Corner Cabinet Mirrors</i>					402
<i>Florescent Mirrors</i>					413
<i>LED Mirrors</i>					405-412
<i>Madrid Mirrors</i>					403
<i>Plain Mirrors</i>					390-391
<i>Sorrento Mirrors</i>					404
<i>Vanity Mirrors</i>					392
Mirrors & Cabinets					389-413
Mistral Bath					
<i>1800</i>					89
Monarch Bath					
<i>1300 Corner</i>					132
Multirail Towel Hangers (Radiators)					635
N					
Neo-Classical					
<i>1700</i>					64
Newlyn Taps					709
Northall Sanitaryware Range					222-223
Northbrook					249-297
Northbrook Accessories					297
Nostalgic Single Lever Shower Valve					653
Novara Range					276-279
O					
Oriole Bath					
<i>1200 Corner</i>					132
Oslo Cabinet Mirror					400
Oslo Combination Vanity Units					353
Oslo Corner Combi Vanity Range					354-357
Oslo Corner WC Unit					343
Oslo Max Vanity Units					352
Oslo Reduced Depth Cistern Unit					363
Oslo Semi Recessed Slimline Vanity Units					359
Oslo Semi Recessed Vanity Units					358
Oslo Tall Cistern Unit					
<i>Dark Walnut</i>					362
<i>High Gloss White</i>					360
<i>Matt Anthracite</i>					361
Oslo 39 Vanity Units					
<i>Dark Walnut</i>					333
<i>High White Gloss</i>					332
<i>Matt Anthracite</i>					332
<i>Wall Hung</i>					364
Oslo 44 Vanity Units					
<i>High Gloss White</i>					334
<i>Matt Anthracite</i>					335
<i>Internal Drawer</i>					344-345
<i>Push Drawer</i>					344-345
<i>Wall Hung Units</i>					365
Oslo 58 Vanity Units					
<i>Dark Walnut</i>					338
<i>High Gloss White</i>					336
<i>Matt Anthracite</i>					337
<i>Internal Drawer</i>					346-347
<i>Push Drawer</i>					346-347
<i>Wall Hung Units</i>					366
Oslo 80 Vanity Units					
<i>High Gloss White</i>					340
<i>Internal Drawer</i>					348-349
<i>Push Drawer</i>					348-349
Oslo 100 Vanity Units					
<i>High Gloss White Double Bowl</i>					342
<i>High Gloss White Single Bowl</i>					341
<i>Internal Drawer</i>					350-351
<i>Push Drawer</i>					350
<i>Wall Cupboards</i>					343
Outlet Elbows With Wall Brackets					676
Ovada LED Mirror					410
P					
Painswick Radiator					618
Panelling					
<i>Hydropanel</i>					484-485
<i>Hydropanel Instructions</i>					487
<i>Mirror Gloss Hydropanel</i>					486
<i>PVC Panel Instructions</i>					488
<i>PVC Widepanel</i>					490-491
Standard PVC Panelling					489
Panels & Screens					135-147
Paradigm Bath					
<i>1550 Freestanding</i>					125
Pegella LED Mirror					411
Peretti Radiator					
<i>Horizontal</i>					574-575
<i>Towel Hangers & Shelves</i>					576-577
<i>Vertical</i>					572-573
Perlita Range					280-285
Pesaro Radiator					531
Piave Range					286-291
Pipe Shrouds & Collar Kits (Radiators)					635
Plain Mirror					391
Plain Mirror Cabinet					399
Pluton Sanitaryware Range					224-225
Portobello Taps					710
Prado Taps					
<i>100</i>					690
<i>300</i>					691
<i>500</i>					686
<i>550</i>					689
<i>580</i>					687
<i>600</i>					682
<i>650</i>					687
<i>700</i>					688
<i>800</i>					690
<i>Cylinder</i>					684
<i>Lever</i>					685
<i>Star</i>					683
Preston Radiator					585
Prestwood Taps					707
Profile Bath					
<i>1500</i>					50
<i>1600</i>					54
<i>1700</i>					65, 77
<i>1600 Duo</i>					54
<i>1650 Duo</i>					58
<i>1700 Duo</i>					66, 77
<i>1800 Duo</i>					87
<i>1500 Showerbath</i>					99
<i>1800 Single Ended</i>					87
PVC Ceiling & Wall Panelling					489
PVC Widepanels					490
Q					
Quadro Sanitaryware Range					226
Quantum Bath					
<i>1700 Duo</i>					66, 78, 82
<i>1800 Duo</i>					92
<i>1900 Duo</i>					95
<i>1700 Duo Integra</i>					78
<i>1500 Integra Eco Low Level</i>					50
<i>1500 Standard Height</i>					50
<i>1600 Low Level</i>					55
<i>1600 Standard Height</i>					55
<i>1700 Low Level</i>					67
<i>1700 Standard Height</i>					67
<i>1500 Showerbath</i>					98
<i>1600 Showerbath</i>					106-107
<i>1700 Showerbath</i>					112-113
<i>1500 Single Ended</i>					51
<i>1600 Single Ended</i>					55, 57
<i>1700 Single Ended</i>					66, 78, 82, 84
<i>1800 Single Ended</i>					86, 92
<i>1500 Single Ended Integra</i>					51
<i>1600 Single Ended Integra</i>					56
<i>1650 Single Ended Integra</i>					59
<i>1700 Single Ended Integra</i>					68, 79, 81
<i>1800 Single Ended Integra</i>					92
<i>Space Saver</i>					71
Quantum Bath Panels					136
Quba Sanitary					

Index

Rosano Radiator	
<i>Horizontal</i>	568–569
<i>Towel Hangers & Shelves</i>	570–571
<i>Vertical</i>	566–567
Round Frosted LED Vanity Mirror	392
Round LED Vanity Mirror	392
Round Vent Caps (Radiators)	637
Rowsham Radiator	
<i>Horizontal</i>	546
<i>Vertical</i>	547
Rubano Radiator	
<i>Horizontal</i>	545
<i>Vertical</i>	544
Rubin Radiator	533
Ryton Towel Rail	536–537

S

Sail Shape Screen With Towel Rail	144
Salerno Range Accessories	302–303
Sanitaryware	173–247
Savannah Mirror	390
Seattle Mirror	390
Semi-Recessed Basins (Sanitaryware)	241
Severn Radiator	620
Seville Tableau	
<i>Anthracite</i>	368
<i>High Gloss White</i>	367
<i>Washed Ash</i>	368
Sherbourne Radiator	620
Sherwood Bath Panels	138
Sherwood Classic Bath Panels	140
Sherwood Classic Vanity Units	383
Sherwood Diamante Bath Panels	139
Sherwood Toilet Seats	142
Sherwood Ultra Bath Panels	140
Sherwood Ultra Vanity Units	383
Shower Bundles	642–645
Shower Enclosures	415–479
Shower Handsets	668–670
Shower Heads	674, 675
Showering	641–677
Shower Panels	665
Shower Screen Options Chart	96
Shower Seat	677
Side Valves	680, 681
Sigma Bath	
<i>1600</i>	57
<i>1700</i>	79, 82
<i>1800</i>	93
<i>1900</i>	95
<i>1800 Showerbath</i>	120–121
Single Knob Mirror Cabinets	396, 399
Sit On Basins (Sanitaryware)	236
Solid Brass Baskets (Accessories)	301
Sorrento	
<i>Ceramic Basin Tops</i>	375
<i>Mirror</i>	404
Sorrento 45 Vanity Units	
<i>Floor Standing</i>	372
<i>Slab</i>	369
<i>Slab Wall Hung</i>	376
Sorrento 60 Vanity Units	
<i>Floor Standing</i>	372
<i>Slab</i>	369
<i>Slab Wall Hung</i>	377
<i>Wall Hung</i>	380
Sorrento 80 Vanity Units	
<i>Floor Standing</i>	373
<i>Slab</i>	370

<i>Slab Wall Hung</i>	377
<i>Wall Hung</i>	381
Sorrento 100 Vanity Units	
<i>Floor Standing</i>	374
<i>Slab</i>	371
<i>Slab Wall Hung</i>	378
<i>Wall Hung</i>	382
Spey LED Mirror	412
Square LED Vanity Mirror	392
Status Bath	
<i>1600</i>	57
<i>1700</i>	69, 83
<i>1500 Showerbath</i>	101
Staverton Radiator	530
<i>Tube on Tube Curved</i>	529
<i>Tube on Tube Straight</i>	528
Stenhouse Taps	712
Stour Radiator	617
Stratford Traditional Riser Kits	667
Swallow Bath	
<i>1700</i>	68
<i>1800</i>	85
Swan Bath	
<i>1700 Offset</i>	130
Swing Bath	52

T

Tamarind Sanitaryware Range	228–229
Taps, Wastes & Accessories	679–720
Tavo Range	292–293
Tec Single Lever Taps	698
Temptation Sanitaryware Range	230–231
Termoli Radiator	532
Thames Radiator	626
Thermostatic Bath	
Shower Mixers	651, 709
Thermostatic Cross Head Valves	654
Thermostatic Shower Pole	661
Thermostatic Shower Pole Inc Bar Valve & Kit	660
Thermostatic Shower Valves	654
Thermostatic Valves (Radiators)	632, 633, 634
Toilet Seats	142
Toilet Seats (Vanity)	387
Topino Range	294–295
Towel Rail Toilet Paper Holder (Radiators)	635
Traditional	
<i>Exposed Twin Thermostatic Valve</i>	656
<i>Riser Kit With Twin Valve</i>	657
<i>Thermostatic Shower Valves</i>	655
Tranquility Bath	
<i>1300 Corner</i>	133
Treviso LED Mirror	412
Triple Concealed	
3/4 Thermostatic Shower Valves	647
Tunstall Radiator	
<i>Horizontal</i>	550
<i>Vertical</i>	548–549
<i>Towel Hangers</i>	636
<i>Tunstall Towel Rails</i>	551
Tuscan Radiator	501
Twin Concealed 3/4	
Thermostatic Shower Valves 6	46
Twyver Radiator	627

U

Ultima Sanitaryware Range	232–233
Urban Bath	
<i>1700</i>	69
<i>1500 Showerbath</i>	100
<i>1700 Showerbath</i>	110–111
<i>1250 Sit Bath</i>	46

Urban Edge Bath	
<i>1575 Showerbath</i>	102
<i>1675 Showerbath</i>	108

V

Valliant Walk-In Shower Enclosures	
<i>Round Pole Walk-in</i>	466
<i>Round Pole Walk-In Offset</i>	469
<i>Round Pole Walk-In With Hand Hold</i>	467
<i>Square Pole Walk-In</i>	466
<i>Square Pole Walk-In Offset</i>	468
Valliant Walk-In Combinations	454–460
Vancouver Mirror	390
Vanguard Shower Enclosures	
<i>Offset Quadrant</i>	453
<i>Quad</i>	452
<i>Slider</i>	450–451
Vanguard Shower Trays	
Vanguard-25 Trays	478–479
Vantage Flipper Walk-In Shower Enclosure	465
Vantage Shower Enclosures	
<i>Bi-Fold Door</i>	445
<i>Corner Entry & Offset Corner Entry</i>	443
<i>Offset Quadrant</i>	444
<i>Pivot Door</i>	439
<i>Quadrant Silver</i>	441
<i>Quadrant White</i>	440
<i>Sliding Door</i>	442
Velor Radiator	
<i>Matt Anthracite Straight</i>	565
<i>Matt White Straight</i>	564
Veroli Thermostatic Shower Set with Shelf	660
Verona Bath	
<i>1700</i>	80
Vesima Radiator	
<i>Horizontal</i>	584
<i>Vertical</i>	582–583
Vieste Radiator	532
Violla Radiator	615
Vivande Taps	705
Volente 1000 & 1250 Bath Screens	127
Volente Bath Screens	
<i>Overbath Slider</i>	143
<i>Volente 1000mm 1 Fixed & 3 Folding</i>	145
<i>Volente 1000mm 4 Fold Screen</i>	145
<i>Volente 1250mm 1 Fixed & 4 Folding</i>	145
<i>Volente 1250mm 5 Fold Screen</i>	145
<i>Volente Hinged Screens</i>	146–147
Volente Shower Enclosures	
<i>Bi-Fold Door</i>	432
<i>Bi-Fold Door With In-line Panel</i>	433
<i>Curved Corner</i>	424
<i>Double Hinge Door</i>	434
<i>Double Sliding Door</i>	417
<i>Frameless Door</i>	416
<i>Frosted Hinged Door</i>	431
<i>Frosted Slider Door</i>	419
<i>Hinged Door</i>	430
<i>Offset Quad</i>	425
<i>Quad</i>	422
<i>Quad With Inline Panel</i>	423
<i>Single Door Offset Quad</i>	427
<i>Single Door Quad</i>	426
<i>Slider Door</i>	418
<i>Slider With In-Line Panel</i>	420–421
<i>Spacesaver Quad</i>	428–429
Volente Shower Trays	
<i>Offset Quad Trays</i>	476–477
<i>Quadrant Trays</i>	473
<i>Rectangular Anti Slip Trays</i>	474
<i>Rectangular Trays</i>	475
<i>Square Trays</i>	472
Volente Walk-In Shower Enclosures	
<i>Clear Glass Walk-In</i>	462
<i>Curved Walk-In</i>	461
<i>Frosted Glass Walk-In</i>	463

Vulcan Shower Enclosures	
<i>Bi-Fold Door</i>	438
<i>Hinge Door</i>	436
<i>Quad</i>	435
<i>Slider Door</i>	437

W

Wall Hung Pans (Sanitaryware)	244
Wall Mounted Shower Arms	672, 673
Wall Mounted Waterfall Showers	671
Walton Taps	700
Wave Bath Panels	138
Wendover Radiator	
<i>Chrome Curved</i>	496–497
<i>White Curved</i>	499
<i>Chrome Straight</i>	494–495
<i>Matt Anthracite Straight</i>	500
<i>White Straight</i>	498
Wendover Taps	692
Westbourne Taps	701
Weston Radiator	563
Westward Radiator	
<i>Chrome Straight</i>	520–521
<i>Gloss White Straight</i>	520–521
Winchcombe Taps	700
Winchester Taps	702
Windrush Radiator	616
Wingrave Radiator	
<i>Chrome Curved</i>	510–511
<i>Chrome Straight</i>	502–503
<i>Gloss White Straight</i>	506–507
<i>Matt Anthracite Straight</i>	504–505
<i>Matt White Straight</i>	508
Wingrave Sanitaryware Range	234–235
Wingrave Taps	701
Winslade Shower Pole	661
Winterbourne Shower Pole	661
Withington Radiator	591
Towel Hangers & Shelves	592–593
Witney Radiator	
<i>Vertical</i>	612

Z

Zone Bath	
<i>1700</i>	80
<i>1800</i>	94
Zurich Cabinet Mirror	401

Eastbrook Co Terms & Conditions

We deliver all goods on our own dedicated transport fleet to ensure a speedy and problem-free service, however, in the unlikely event that goods are delivered wrong or damaged, it is the responsibility of the customer to ensure sufficient time is allowed for a replacement to be sent.

1. DEFINITIONS

In these terms and conditions, the following words shall have the following meanings:

'Buyer' shall mean any person, Eastbrook or company, to whom Eastbrook supplies Goods or Services or with whom Eastbrook enters into negotiations for the supply of Goods or Services.

'Eastbrook' shall mean Brian Michael Douuss and Nicolas Brian Douuss (each a "Partner" together the "Partners") trading as "Eastbrook Co." or "Woodstock".

'Goods' shall mean products, articles or things which are supplied by or which are the subject of negotiations for supply by Eastbrook to the Buyer.

'Services' shall mean services are supplied by or which are the subject of negotiations/ or supply by Eastbrook to the Buyer.

2. MAKING THE CONTRACT

2.1 Eastbrook's salesmen are not authorised representatives and are not authorised to accept confirm or vary any order nor to make any representation or promise on Eastbrook's behalf.

2.2 Any estimate/quotation which comprises an invitation to treat is open for a period of 30 days only from the date thereof, provided that Eastbrook has not previously withdrawn it. Any order issued by the Buyer is subject to acceptance by Eastbrook and a contract will only be formed when Eastbrook has accepted the Buyer's offer to buy in writing. Any offer made by the Buyer must be confirmed in writing by the Buyer.

2.3 All orders are placed under these terms and conditions alone.

2.4 These terms and conditions exclude any other terms and conditions inconsistent therewith which a Buyer might seek to impose even though such other terms and conditions may be submitted in a later document and/or purport to exclude or supersede any terms or conditions with them or may be contained in any offer acceptance or counter-offer made by the Buyer.

2.5 No variation of these terms and conditions is permitted unless expressly accepted by a Partner of Eastbrook in writing.

3. CANCELLATION

3.1 No cancellation by the Buyer is permitted except where expressly agreed by a Partner of Eastbrook in writing.

3.2 The Buyer will in the event of agreed cancellation by the Buyer indemnify Eastbrook fully against all expenses incurred up to the time of such cancellation together with by way of liquidated damages a sum of 33 1/3% of the contract price which shall be paid by the Buyer to Eastbrook Forthwith.

4. PRICE

4.1 All prices quoted are those ruling at the date of dispatch or supply.

4.2 Unless otherwise stated all prices quoted are nett, exclusive of VAT, and in the case of Goods ex works.

4.3 Eastbrook reserves the right at any time prior to delivery of the Goods or supply of Services to adjust the price to take account of any increase in the cost of raw materials, labour or services or any currency fluctuations affecting the cost of imported materials or services.

5. TERMS OF PAYMENT

5.1 All sums become due and payable under these terms and conditions not later than 14 days from date of invoice.

5.2 Time for payment shall be of the essence.

5.3 The Buyer shall have no right to set off, statutory or otherwise.

5.4 If the Buyer (being a Company) has a petition for its winding-up or passes a resolution for voluntary winding-up otherwise than for the purpose of a bona fide amalgamation or reconstruction or compounds with its creditors or has a receiver appointed of all or any part of its assets or (being an individual) becomes bankrupt or insolvent or enters into any arrangement with its creditors or commits a material or serious breach of this Agreement (and in the case of such a breach being remediable fails to remedy it within 7 days of receiving notice to do so) he will be deemed to have repudiated the Contract.

5.5 Eastbrook reserves the right at any time at its discretion to demand security for payment before continuing with or delivering any Order, supplying any Goods or Services.

6. DELIVERY

6.1 Delivery will be deemed to have been effected when the Goods are ready for collection at the premises of Eastbrook or as the case may be the premises of the suppliers to Eastbrook in circumstances where the Goods are delivered direct from such suppliers.

6.2 Time of delivery is not of the essence.

6.3 Eastbrook shall not be liable for any loss whatsoever or howsoever arising caused by its non-delivery or by the failure to make Goods ready for collection on the due date.

6.4 Eastbrook reserves the right to make delivery by instalments and to tender a separate invoice in respect of each instalment.

6.5 When delivery is to be by instalments or Eastbrook exercises its right to deliver by instalments under clause 6.4 hereof or if there be delay in the delivery of any one or more instalments for whatever reason this will not entitle the Buyer to treat the contract as repudiated and/or to damages.

6.6 Deviations in quantity between the Goods delivered and Goods ordered representing not more than 10 per cent by value shall not give the Buyer any right to reject the Goods or to claim damages and the Buyer shall be obliged to accept and pay at the contract rate for the quantity of the Goods delivered.

7. SUPPLY OF SERVICES

7.1 Time for the supply of Services is not of the essence.

7.2 Eastbrook shall not be liable for any loss whatsoever or howsoever arising caused by its failure to supply Services or any part thereof on the due date.

7.3 Eastbrook reserves the right to supply Services by instalments and to tender a separate invoice in respect of each instalment.

7.4 When the supply of Services is to be by instalments or Eastbrook exercises its right to supply Services by instalments under clause 7.3 hereof or if there be a delay in the supply of any one or more instalments of Services for whatever reason this will not entitle the Buyer to treat the contract as repudiated or to damages.

7.5 Deviation in the quantity between Services supplied and the Services ordered representing not more than 10 per cent by value shall not give the Buyer any right to reject the Services or to claim damages and the Buyer shall be obliged to accept and pay at the contract rate for the quantity of the Services supplied.

8. RISK AND THE PASSING OF PROPERTY IN GOODS

8.1 Risk in the Goods shall pass to the Buyer when the Goods are delivered.

8.2 Notwithstanding risk in the Goods passing in accordance with clause 8.1 hereof title in the Goods shall not pass to the Buyer until whichever shall be the first to occur of the following:-

8.2.1 payment being received by Eastbrook for the Goods and Services and no other amounts then being outstanding from the Buyer to Eastbrook in respect of other Goods or Services supplied by Eastbrook

8.2.2 the Buyer selling the Goods in accordance with the provisions of these terms and conditions in which case title to the Goods shall be deemed to have passed to the Buyer immediately prior to delivery of the Goods to the Buyer's customers; and

8.2.3 Eastbrook waiving its rights under this clause 8.2 in respect of specified Goods or Services whereupon title to the said Goods shall forthwith vest in the Buyer.

8.3 The Buyer is licensed by Eastbrook to use or to agree to sell the Goods

delivered to the Buyer subject to the express condition that the entire proceeds of any sale are held in trust for Eastbrook and are not mixed with other moneys or paid into an overdraft bank account and shall at all times be identifiable as Eastbrook's moneys.

8.4 Until title to the Goods passes:

8.4.1 The Buyer will hold the Goods as fiduciary agent and bailee for Eastbrook;

8.4.2 the Goods shall, subject to clause 8.3, be kept separate and distinct from all other property of the Buyer and of third parties and in good and substantial repair and condition and be stored in such a way as to be clearly identifiable as belonging to Eastbrook;

8.4.3 Eastbrook may at any time revoke the power of sale and use contained in clause 8.3 by notice to the Buyer if the Buyer is in default for longer than 14 days in the payment of any sum whatsoever due to Eastbrook (whether in respect of the Goods or any other Goods or Services supplied at any time by it to the Buyer) or if Eastbrook has bona fide doubts as to the solvency of the Buyer;

8.4.4 The Buyer's power of sale and use contained in clause 8.3 shall automatically cease if the Buyer has a petition presented for its winding-up or passes a resolution for voluntary winding-up otherwise than for the purpose of a bona fide amalgamation or reconstruction or compounds with its creditors or has a receiver appointed of all or any part of its assets or becomes bankrupt or insolvent or enters into any arrangements with creditors or takes or suffers any similar action in consequence of debts or carries out or undergoes any analogous act or proceeding under foreign law;

8.4.5 upon determination of the Buyer's power of sale and use pursuant to clause 8.4.3 or clause 8.4.4, the Buyer shall place any of the Goods in its possession or under its control and unsold at the disposal of Eastbrook and Eastbrook shall be entitled to enter upon any premises of the Buyer for the purpose of removing such Goods;

8.5 Eastbrook shall at any time be entitled to appropriate any payments made by the Buyer in respect of any Goods or Services in settlement of such invoices or accounts in respect of such Goods or Services as Eastbrook may in its absolute discretion think fit notwithstanding any purported appropriation to the contrary by the Buyer.

9. LIEN AND STOPPAGE

9.1 Until such time as the title in the Goods has passed to the Buyer Eastbrook has the right to withhold delivery if the Buyer (being a Company) has a petition presented for its winding-up or passes a resolution for voluntary winding-up otherwise than for the purpose of a bona fide amalgamation or reconstruction or compounds with its creditors or has a receiver appointed of all or any part of its assets or (being an individual) becomes bankrupt or insolvent or enters into any arrangements with creditors or takes or suffers any similar action in consequence of debts or carries out or undergoes any analogous act or proceedings under foreign law.

9.2 When the title in the Goods has passed to the Buyer and the time for payment has failed due but payment has not been made or if the Buyer (being a Company) has a petition presented for its winding-up or passes a resolution for voluntary winding-up otherwise than for the purposes of a bona fide amalgamation or reconstruction or compounds with its creditors or has a receiver appointed of all or any part of its assets or (being an individual) becomes bankrupt or insolvent or enters into any arrangements with creditors or takes or suffers any similar action in consequence of debts or carries out or undergoes any analogous act or proceedings under foreign law Eastbrook has

9.2.1 a lien on the Goods so long as Eastbrook is in possession of them

9.2.2 a right of stoppage in transit

9.2.3 a right of resale

For the avoidance of doubt it is hereby declared that nothing in this clause shall affect the rights given to Eastbrook by ss.38-48 of the Sale of Goods Act 1979.

10. INSPECTION/SHORTAGES

10.1 The Buyer is under a duty to inspect the Goods forthwith on delivery and satisfy himself as to the due performance of Services forthwith after supply.

10.2 Eastbrook shall be under no liability for any defects or shortages that would be apparent on careful inspection if the terms of this clause are not complied with, and, in any event will be under no liability if a written complaint is not delivered to Eastbrook within 7 days of delivery or supply detailing the alleged defect or shortage.

10.3 In all cases where defects or shortages in respect of Goods are complained of Eastbrook shall be under no liability in respect thereof unless an opportunity to inspect the Goods is given to Eastbrook before any use is made thereof or any alteration or modification is made thereto by the Buyer.

10.4 Subject to clauses 10.2 and 10.3 Eastbrook shall make good any defect or shortage in the Goods and where appropriate replace any Goods damaged in transit as soon as it is reasonably able to do so, but otherwise shall be under no liability whatsoever or howsoever arising from such defect, shortage or damage.

10.5 Subject to clause 10.4 Eastbrook shall remedy any defect in the supply of Services as soon as it is reasonably able to do so but otherwise shall be under no liability whatsoever or howsoever arising from such defect

11. WARRANTY

11.1 No representation or warranty is given as to the suitability or fitness of the Goods or Services for any particular purpose and the Buyer shall satisfy himself in this respect and shall be totally responsible therefore

11.2 If the Goods are in such a state or the Services so defectively supplied as would but for this condition entitle the Buyer to repudiate the contract and/or claim damages from Eastbrook Eastbrook reserves the right to repair or replace the Goods or perform the Services (or the relevant part thereof) again.

12. LIABILITY

12.1 Introduction

12.1.1 Nothing in this clause 12 shall be deemed to exclude or restrict Eastbrook's liability for death or personal injury resulting from Eastbrook's negligence.

12.1.2 Each of the sub-clauses in this clause 12 is to be treated as separate and independent.

12.1.3 Eastbrook is willing to undertake liability additional to that provided by this clause 12 in exchange for a higher price.

12.2 Exclusion

12.2.1 Eastbrook agrees that if any defect caused by faulty design, manufacture, materials or workmanship is discovered during the period of 3 months commencing with the date of delivery or supply, Eastbrook will remedy any defect at its own expense or, in the case of Goods if it chooses to do so, replace them or the parts thereof by a new use, misuse, neglect or willful or accidental damage are not covered by this clause.

12.2.2 The Buyer cannot claim the benefit of clause 12.2.1 above unless he informs Eastbrook of the relevant defect in writing within 7 working days of discovering it, and

in the case of Goods, he returns the Goods to Eastbrook at his own expense.

12.2.3 The risk of accidental loss whilst any Goods are being returned to Eastbrook will be borne by the Buyer.

12.2.4 Notwithstanding clause 12.2.1 above, if the manufacturer of any Goods has provided any guarantee of such Goods for longer than three months (a "Manufacturer's Extended Guarantee"), Eastbrook shall use its reasonable endeavours to transfer to the Buyer the benefit of any such Manufacturer's Extended Guarantee in respect of the Goods, provided that Eastbrook may in its absolute discretion elect to do so only at the cost of the Buyer.

12.2.5 Any Manufacturer's Extended Guarantee is for the Buyer only who must complete a return and registration form within 30 days of purchase. Manufacturer's Extended Guarantees are not transferable to third parties and do not cover previously installed products such as ex showroom displays. Failure to complete a return and registration form to Eastbrook within the 30 day period will result in the guarantee on such Goods being limited to that stated in clause 12.2.1 above.

12.2.6 Manufacturer's Extended Guarantees cover Goods which are used for normal domestic use only and are not applicable to Goods which are used for commercial use (i.e. hotels, residential homes, leisure facilities etc.).

12.2.7 In the event that a manufacturer of Goods providing a Manufacturer's

Extended Guarantee pursuant to clause 12.2.3 above ceases trading and/ or no longer honours such guarantee, Eastbrook shall have no liability whatsoever to the Buyer with respect to such Manufacturer's Extended Guarantee.

12.2.8 If the benefit of a Manufacturer's Extended Guarantee is transferred to the Buyer subject to clause 12.2.1 above and further subject to the defect not being as a result of fair wear and tear, Eastbrook shall only be liable to provide replacement parts. For the avoidance of doubt, Eastbrook excludes any consequential costs involved in the fitting of such parts. Furthermore, with respect to the following these additional terms are applicable:

Perishable components such as non-glass or metallic parts (e.g. plastic parts, seals, wheels etc.) are excluded from a Manufacturer's Extended Guarantee.

Shower and bath screens: Glass and seals for such products are excluded from a Manufacturer's Extended Guarantee.

Towel rails and radiators: Such products must be individually earthed when installed for a Manufacturer's Extended Guarantee to apply.

12.2.9 If, in the sole opinion of Eastbrook, the Goods which are the subject of the Manufacturer's Extended Guarantee have been modified, misused or neglected or have been willfully or accidentally damaged, Eastbrook shall not be liable under the Manufacturer's Extended Guarantee for the failure of the Goods.

12.2.10 No claim under a Manufacturer's Extended Guarantee will be accepted if Goods have been installed with a fault that would have been clearly visible before installation. A Manufacturer's Extended Guarantee does not cover any Goods which have been modified, altered, transformed or relocated in any way.

12.2.11 Claims under a Manufacturer's Extended Guarantee must be made by the Buyer within [7 working days] of the defect being discovered.

12.2.12 In consideration for receiving the benefit of this clause, the Buyer agrees that, apart from those terms set out in clause 10 and 11, all other terms, whether conditions, warranties or innominate terms, express or implied, statutory or otherwise, are excluded from the contract between Eastbrook and the Buyer to the extent permitted by law (except where the Buyer deals as consumer within section 12 of the Unfair Contract Terms Act 1977 when the terms implied by sections 13, 14 and 15 of the Sale of Goods Act 1979 shall be implied into the contract).

12.3 Exclusion of Consequential Loss

Eastbrook shall not be liable for any consequential or indirect loss suffered by the Buyer whether such loss arises from breach of a duty in contract or tort or in any other way (including loss arising from Eastbrook's negligence) including, without limitation to the generality of the foregoing:

- loss of profits;

- loss of contracts;

- damage to property of the Buyer or anyone else; or

personal injury to the Buyer or anyone else (except so far as such injury is attributable to Eastbrook's negligence).

12.4 Limitation
Eastbrook's total liability for any one claim or for the total of all claims arising from any one act or default of Eastbrook (whether arising from Eastbrook's negligence or otherwise) shall not exceed the contract price of the Goods.

13. FORCE MAJEURE

13.1 Eastbrook shall not be liable for any failure to deliver the Goods or perform the Services arising from circumstances outside Eastbrook's control.

13.2 Non-exhaustive illustrations of such circumstances would be act of God, war, riot, explosion or other weather conditions, fire, flood, strikes, lockouts, Government action or regulations (UK or otherwise), delay by suppliers, accidents and shortage of materials, labour or manufacturing facilities.

13.3 Should Eastbrook be prevented from delivering the Goods or performing the Services in the above circumstances, it shall give the Buyer written notice of this fact as soon as reasonably practicable after discovering it.

13.4 If the circumstances preventing delivery of the Goods or performing the Services are still continuing three months after the Buyer receives Eastbrook's notice, then either party may give written notice to the other cancelling the contract.

13.5 If the contract is cancelled in this way, Eastbrook will refund any payment which the Buyer has already made on account of the price (subject to deduction of any amount Eastbrook is entitled to claim from the Buyer) but Eastbrook will not be liable to compensate the Buyer for any further loss or damage caused by the failure to deliver the Goods or perform the Services.

14. SALES PROMOTION DOCUMENTATION

Whilst Eastbrook takes every precaution in the preparation of its catalogue, technical circulars, price lists and its other literature, these documents are for the Buyer's general guidance only and the particulars contained therein shall not constitute representations by Eastbrook and Eastbrook shall not be bound thereby.

15. USE OF DATA

15.1 If the Buyer provides any data relating to the business of the Buyer to Eastbrook for any purpose, then the Buyer agrees that Eastbrook may hold such data and use it in relation to the supply of Goods, to process payment and to inform the Buyer (including all its staff) of other Goods or Services that Eastbrook may offer from time to time. Eastbrook will hold all data relating to the Buyer in accordance with our privacy policy and privacy statements in force from time to time and which is available on demand.

15.2 The Buyer agrees that Eastbrook may share any data referred to in clause 15.1 with third parties only where it is necessary for the provision of the Goods or Services supplied by Eastbrook and further that the Buyer shall hold Eastbrook harmless for the misuse of such data by those third parties.

15.3 In relation to any data supplied by the Buyer to Eastbrook regarding the Buyer's customers, the Buyer warrants and represents that they have obtained consent to share such data with Eastbrook (whether this relates to remedial services or the replacement of Goods or otherwise) and the Buyer agrees to indemnify and keep indemnified, Eastbrook from and against any losses, damages, liability, costs (including legal fees) and expenses incurred by Eastbrook as a result of or in connection with the Buyers breach of this Clause.

16. NOTICES

Any notice to be given hereunder shall be in writing and shall be deemed to have been duly given if sent or delivered to the party concerned at its address specified overleaf or such other address as that party may from time to time notify in writing and shall be deemed to have been served, if sent by post, 48 hours after posting.

17. ASSIGNMENT

Neither Eastbrook nor the Buyer shall assign or purport to assign or transfer the contract or the benefits thereof to any other person without prior written consent of the other party.

18. SEVERANCE

18.1 If any provision of this contract (or part of any provision) is or becomes illegal, invalid or unenforceable, the legality, validity and enforceability of any other provision of the Contract shall not be affected.

18.2 If any provision of the contract (or part of any provision) is or becomes illegal, invalid or unenforceable but would be legal, valid and enforceable if some part of it was deleted or modified, the provision or part-provision in question shall apply with such deletions or modifications as may be necessary to make the provision legal, valid and enforceable. In the event of such deletion or modification, the parties shall negotiate in good faith in order to agree the terms of a mutually acceptable alternative provision.

19. PROPER LAW AND JURISDICTION

The Contract shall be governed by and construed in accordance with English law and all disputes arising in connection with the contract shall be submitted to the jurisdiction of the English Courts.

20. HEADINGS

The headings of these conditions are for convenience only and shall have no effect on the interpretation thereof.

Eastbrook

www.eastbrooktrade.com

Eastbrook Co.

Eastbrook Road, Gloucester GL4 3DB

Tel: 01452 317800

Fax: 01452 330494

For Sales / Enquiries: sales@eastbrookco.com

For Orders Only: orders@eastbrookco.com

For Technical Enquiries: technical@eastbrookco.com



Issue 41 / October 1st -
January 31st 2020

ACS
REGISTRARS
Quality Assurance
ISO 9001

**Affordable
LUXURY**